

The Cross-Vane, W-Weir and J-Hook Vane Structures...Their Description, Design and Application for Stream Stabilization and River Restoration

D. L. Rosgen, P.H.*

* Professional Hydrologist, Wildland Hydrology, Inc. 1481 Stevens Lake Road. Pagosa Springs, Colorado 81147; PH 970-731-6100; wildlandhydrology@pagosa.net

Abstract

The descriptions, design specifications, placement locations, spacing and various applications of Cross-Vane, W-Weir and J-Hook Vane structures are presented. These structures were developed and subsequently applied to: 1) establish grade control, 2) reduce streambank erosion, 3) facilitate sediment transport, 4) provide for irrigation diversion structures, 5) enhance fish habitat, 6) maintain width/depth ratio, 7) improve recreational boating, 8) maintain river stability, 9) dissipate excess energy, 10) withstand large floods, 11) maintain channel capacity, 12) be compatible with natural channel design, and 13) be visually acceptable to the public.

Relations to determine the minimum size of rock for these structures are presented based on bankfull shear stress. Drawings for each structure are provided that display appropriate use of footers, cross-section shape, profile shape, appropriate channel locations, angles, slopes, spacing and elevations. Velocity isovels are presented to describe changes in the distribution of energy produced by the structures. The structures all reduce near-bank shear stress and stream power, while increasing center channel shear stress and stream power to retain both flood-flow and sediment transport capacity. These structures have been installed on 14 rivers with bankfull widths varying from 9m (Lower Blanco River in Southwestern Colorado) to 150m (Bitterroot River in Northwestern Montana) and slopes varying from 0.05 to .0003 and in bed material ranging from cobble and gravel to sand bed streams. Since 1986, the author has restored and monitored a wide variety of stream types involving over 48 km of rivers and evaluated various structure performance following major floods. This monitoring has resulted in the development, implementation and assessment of the Cross-Vane, W-Weir and J-Hook vane structures.

Introduction

Structures in river engineering are designed to help stabilize channel boundaries. However, monitoring their effectiveness have indicated that many structures, contrary to the intended design, caused river instability. Structures are often selected and installed without an understanding of sediment transport and violate the dimension, pattern and profile of the stable river. Relations for canal design based on rigid boundary theory, clear water discharge, and uniform flow have been implemented on natural channels, with less than effective results. Work conducted by Leopold, et al, (1964) found that river form is associated with an integration of eight interrelated variables, that if any one variable is changed, it sets up mutual, concurrent adjustments of the other variables in the stream system until a new quasi-equilibrium is reached (stability). The eight variables are slope, width, depth, velocity, discharge, boundary roughness, size of sediment transported, and concentration of sediment. The variables can be integrated into morphological relations for stable natural rivers as described by "reference reach" by stream type

(Rosgen, 1998). Structures are often placed in rivers in an attempt to correct some of the adverse effects of channel adjustment due to instability. Unfortunately, many structures are often installed to “patch a symptom” rather than achieve the stable channel form. Appropriately used structures can assist in maintaining the stable dimension pattern and profile (Rosgen, 1996).

River engineering structures need to be incorporated with a clear understanding of the river variables that constitute the stable form. Structure failures are generally associated with designs incompatible with the “rules of the river”. For example, cross-channel check dams decrease energy slope upstream of the structure. Data from natural rivers indicate a negative power function relation between sinuosity and slope (Figure 1), thus when slope is decreased there is a corresponding increase in sinuosity through lateral migration following bank erosion. Most failures of check dams occur when they are “out flanked” by the river through lateral adjustment upstream of the structure. Consequently, many check dams often accelerate excess bank erosion. Check dams generally decrease upstream velocity, slope, and depth, increase roughness, and induce sediment deposition. These changes lead to instability and contribute to the failure of the structure. Structures have also failed due to excessive bedload deposition that leads to a loss of channel capacity and subsequent change in the stable dimension, pattern and profile of the river.

Streambank stabilization structures proliferate as bank erosion accelerates. Most of the structures implemented involve “hardening” the banks. Changes in near-bank stress and/or stream power associated with unstable channels can accelerate bank erosion. Work conducted by Parker (1978), and Bathurst (1979), described secondary circulation patterns and the distribution of boundary shear stress in both straight and meandering rivers. Ikeda, et al, (1988), described the erosion and transport of grains from the bank region to the center of the channel as a result of bank erosion. They also described the process of lateral momentum transfer due to turbulence that resulted in eddy diffusion and induced net lateral transport of longitudinal fluid momentum from regions of high momentum to regions of low momentum. These processes resulted in a lateral redistribution of bed shear stress. Secondary cells associated with down welling (high boundary shear stress) and upwelling (low boundary shear stress) occur in the near-bank region creating very high velocity gradients (Bathurst, et al, 1979). Boundary shear stresses associated with high velocity gradients, can accelerate erosion rates, and are shown in the velocity isovel constructed from vertical velocity profiles (Figure 2). The streambank erosion prediction methodology developed by Rosgen (1996, 2001), utilizes computations of near-bank stress for assessing various erosion rates. Any structures that can reduce near-bank stress will reduce bank erosion by several orders of magnitude.

New attempts at similar problems

To offset near-bank forces to reduce streambank erosion, Paice and Hey (1989) installed submerged concrete vanes on the outside of meander bends to control secondary circulation and redirect river currents to decrease boundary shear stress in the outer bank region. These attempts were successful in reducing erosion by redirecting erosive currents in the near-bank region. Iowa Vanes (Ogdaard and Mosconi, 1987) were previously used to redirect currents away from streambanks to reduce accelerated erosion. Submerged vanes were installed and tested by Hey (1992) not only to re-direct velocity distribution but to also provide improved fish habitat.

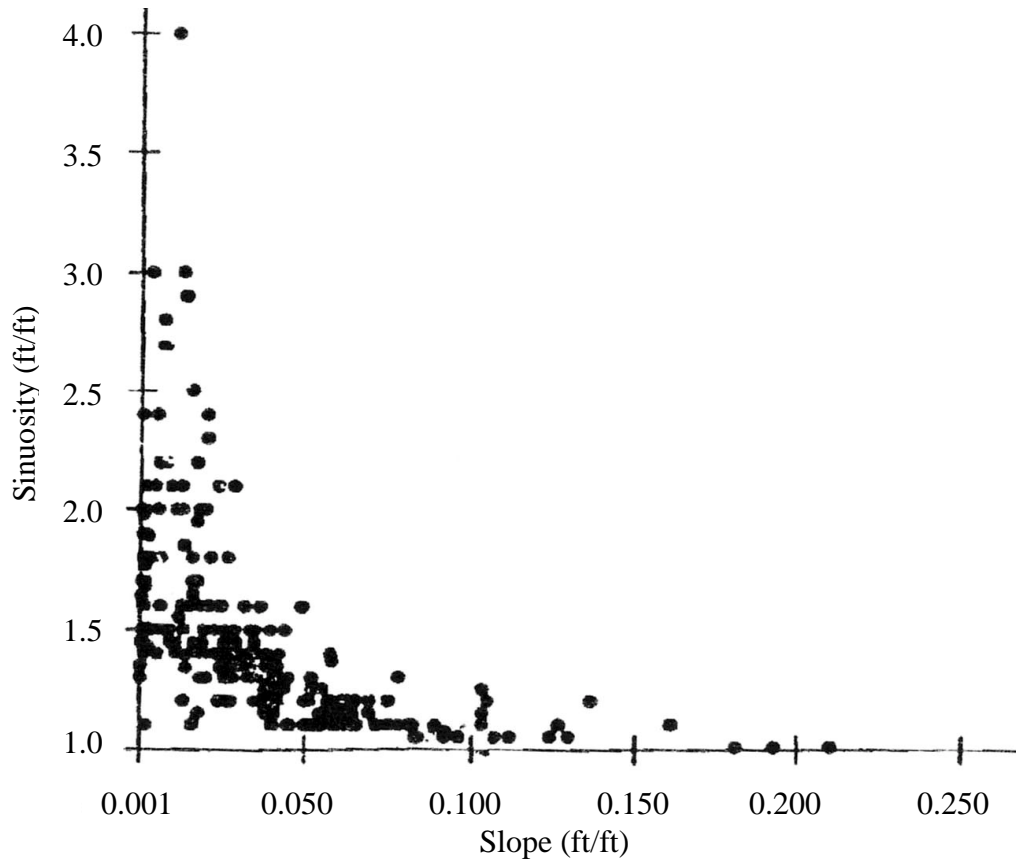

Figure 1. Relation of sinuosity to slope for natural rivers

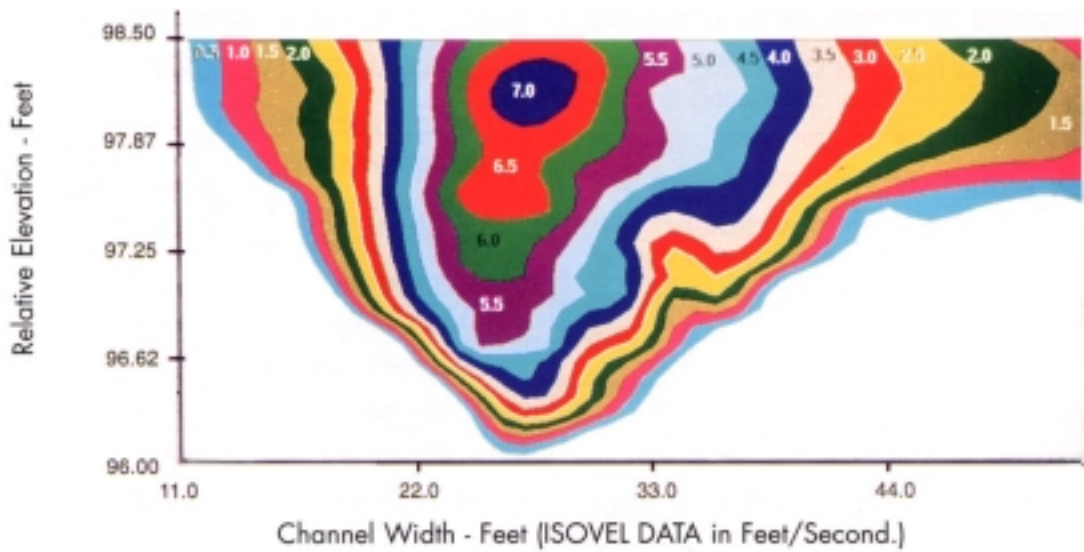

Figure 2. Velocity isovels for a "C3" stream type reach showing variations in velocity distribution (Rosgen, 1996, pg 6-42).

Structures that modify velocity distribution such as deflectors, bank barbs, spur dikes and other similar designs often accompany “bank hardening.” The US Army Corps of Engineers recently developed bendway rock weirs (Derrick, et al, 1994). This structure points slightly upstream at a departure angle of 60-70 degrees from a tangent line from the bank. The intent of the bendway weir was initially to “scalp” point bars and re-locate the thalweg to the inside of the bend for navigation. In addition, this structure subsequently induced sediment deposition in the near-bank region. There is generally re-circulation, back eddy erosion on the upstream side of the structure due to the abrupt nature of re-directing the angle of attack of the near-bank velocity vectors. This structure has been installed on large rivers and has been effective in meeting its design objectives in many instances (Derrick, 1996).

Spur dikes and bank barb structures are common bank protection structures but generally produce an upstream and downstream re-circulation eddy that often increases bank erosion. This tends to occur when the thalweg is forced too far across the channel and/or the structures are oriented 45 to 90 degrees upstream from a tangent line to the bank. Bank barbs create a vertical vortices due to their abrupt angle to the bank that is often responsible for bank erosion and accelerated scour at the “point” of the barb. Rock and/or log deflector structures, pointing downstream, often direct the velocity vectors into the bank when flows overtop the structure increasing near-bank velocity gradients and causing accelerated bank erosion. Subsequently, some of these structures have created unexpected adverse adjustments in the channel.

Vortex Rock Weirs and Root Wads were installed in the 1980s for grade control, fish habitat and streambank erosion protection (Rosgen, 1996). After monitoring for approximately 15 years, the author determined that these structures produced back-eddy erosion during major floods resulting in streambank erosion and the loss of some structures. The problems of the Root Wad and Vortex Rock Weir structures were documented which subsequently led to major changes in their design.

As additional objectives of river engineering have evolved there has arisen a need for a “softer” substitute for streambank stabilization. The departure from traditional “hard” procedures has been slow but steady as the use of natural materials and methods have grown in popularity. This has, in turn, encouraged the pursuit of additional techniques to offset existing problems of various structures observed in the field. A properly designed river structure should meet more than one specific objective (such as grade control).

Structures should also:

1. Maintain the stable width/depth ratio of the channel;
2. Maintain the shear stress to move the largest size particle to maintain stability (competence);
3. Decrease near-bank velocity, shear stress or stream power;
4. Maintain channel capacity;
5. Ensure stability of structure during major floods;
6. Maintain fish passage at all flows;
7. Provide safe passage or enhance recreational boating;
8. Improve fish habitat;
9. Be visually compatible with natural channels;
10. Be less costly than traditional structures;

11. Create maintenance-free diversion structures;
12. Reduce bridge pier/footer scour, road fill erosion and prevent sediment deposition.

The use of rip-rap, gabions, concrete lined channels, bin walls, interlocking blocks, groynes, Kelner Jacks, spur dikes, rock jetties, barbs, reinforced revetment, sheet piling, log cribs, concrete check dams, and loose rock check dams are not only expensive but often do not meet the above stated objectives for river structures. A central problem with riprap, gabions, toe rock protection and similar structures is the increase in near-bank velocity, velocity gradient, stream power, and shear stress. These problems often lead to either on-site failures or problems immediately upstream and/or downstream of the structures. This, in combination with their high cost, resultant poor fish habitat and “less than natural” appearance, led to the development in the early 1990’s of the Cross-Vane, W-Weir and J-Hook Vane.

Description of Structures

Cross-Vane

General description

The design of the Cross-Vane structure is shown in plan, profile and section view in Figure 3. The Cross-Vane is a grade control structure that decreases near-bank shear stress, velocity and stream power, but increases the energy in the center of the channel. The structure will establish grade control, reduce bank erosion, create a stable width/depth ratio, maintain channel capacity, while maintaining sediment transport capacity, and sediment competence. The Cross-Vane also provides for the proper natural conditions of secondary circulation patterns commensurate with channel pattern, but with high velocity gradients and boundary stress shifted from the near-bank region. The Cross-Vane is also a stream habitat improvement structure due to: 1) an increase in bank cover due to a differential raise of the water surface in the bank region; 2) the creation of holding and refuge cover during both high and low flow periods in the deep pool; 3) the development of feeding lanes in the flow separation zones (the interface between fast and slow water) due to the strong downwelling and upwelling forces in the center of the channel; and 4) the creation of spawning habitat in the tail-out or glide portion of the pool.

The Cross-Vane is also a popular boating feature as kayakers routinely do “enders” and “surf” the vane portion of the structures installed on the Lake Fork of the Gunnison River near Lake City, Colorado and the San Juan River in Pagosa Springs, Colorado. The invert portion (center 1/3, see Figure 3) of the structure creates a standing wave, but is associated with a “run” immediately downstream of the invert. As a result the potential development of a dangerous recirculation pool that traps “swimming paddlers” is eliminated. The structure “chutes” the swimmers and/ or their boats into the deep, low velocity pool approximately half a bankfull width below the invert.

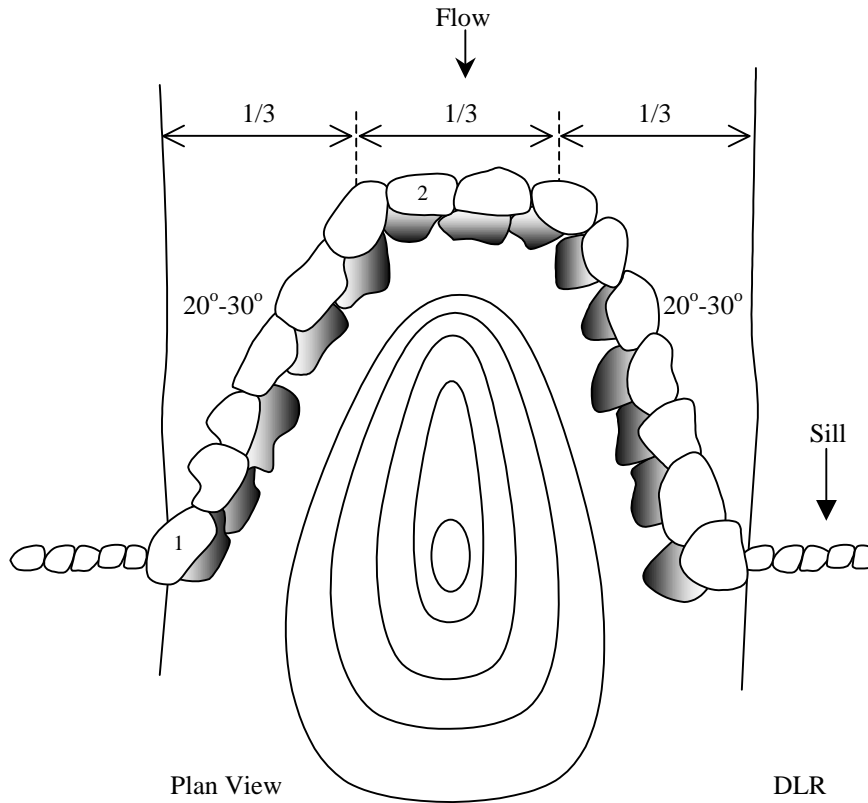
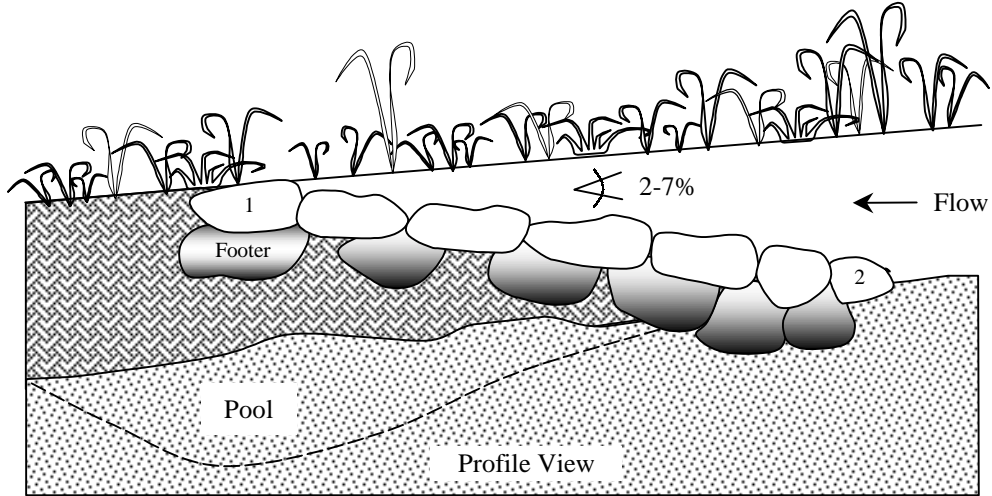
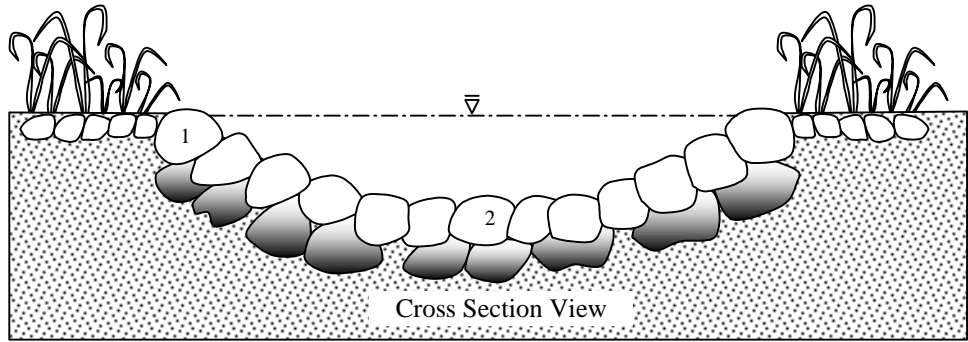

Figure 3. Cross section, profile and plan view of a Cross-Vane

Major floods have tested the Cross-Vane structure such as the 1996 flood on the San Juan River in Pagosa Springs, which passed a flood stage of 3.5 meters above the top of the structures on a 0.005 slope. A detailed contour map prepared in 2000 demonstrates the channel shape and location of the deep pool (Figure 4). The structure did require post-flood maintenance and it is still performing properly as a diversion structure, a kayak playground and an excellent fly-fishing location where fisherman can be frequently observed. Although bedload transport of particle size up to 220 mm occurred during the flood, the pools did not fill. The strong downwelling currents in the center of the channel maintained a high bedload transport keeping the pool deep as evidenced in Figure 4.

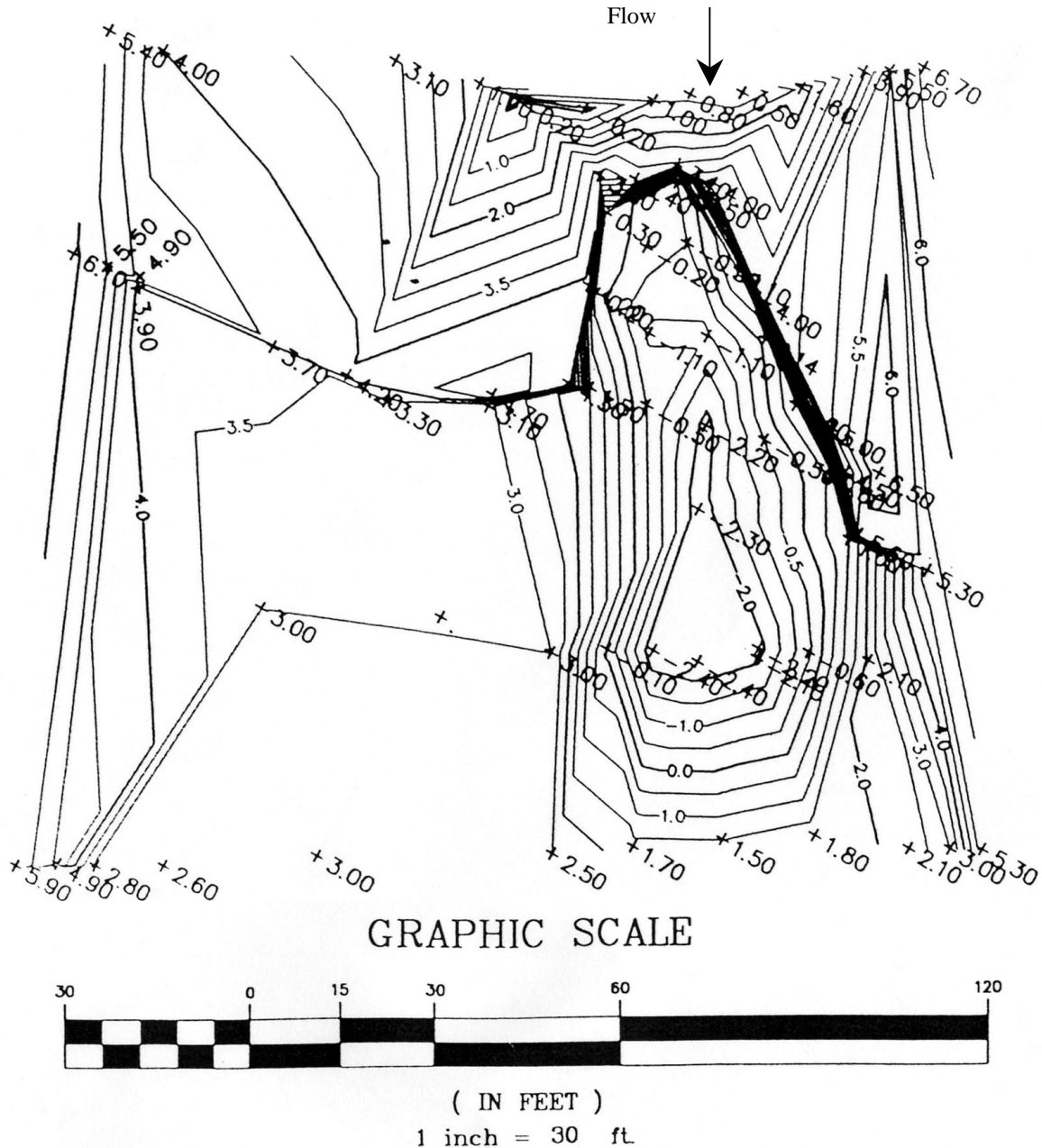

Figure 4. Contour map of Cross-Vane following major flood – San Juan River, CO.

W-Weir

General Description. The design of the W-Weir (W as looking in the downstream direction) was initially developed to resemble bedrock control channels on larger rivers. Various rock weirs installed across larger rivers for fish habitat, grade control and bank protection often create an unnatural and uniform “line of rocks” that detracts from visual values. The W-Weir is similar to a Cross-Vane in that both sides are vanes directed from the bankfull bank upstream toward the bed with similar departure angles. From the bed at $\frac{1}{4}$ and $\frac{3}{4}$ channel width, the crest of the weir rises in the downstream direction to the center of the bankfull channel creating two thalwegs (Figure 5). The objectives of the structure are to provide grade control on larger rivers, enhance fish habitat, provide recreational boating, stabilize stream banks, facilitate irrigation diversions, reduce bridge center pier and foundation scour, and increase sediment transport at bridge locations. Double W-Weirs are constructed on very wide rivers and/or where two center pier bridge designs (three cells) require protection.

Habitat for trout is enhanced by maximizing usable holding, feeding and spawning areas. Fish hold in the multiple feeding lanes created by the two thalweg locations and pools. Various age classes of trout also hold in the deep glide created upstream of the structure and against both banks due to the increased depth and reduced velocity of flows in the near-bank region.

Spawning habitat is created in the tail-out of the pools due to upwelling currents and a sorting of gravel bed material sizes preferred by trout.

J-Hook Vane

General Description. The J-Hook Vane is an upstream directed, gently sloping structure composed of natural materials. The structure can include a combination of boulders, logs and root wads (Figures 6-7) and is located on the outside of stream bends where strong downwelling and upwelling currents, high boundary stress, and high velocity gradients generate high stress in the near-bank region. The structure is designed to reduce bank erosion by reducing near-bank slope, velocity, velocity gradient, stream power and shear stress. Redirection of the secondary cells from the near-bank region does not cause erosion due to back-eddy re-circulation. The vane portion of the structure occupies $\frac{1}{3}$ of the bankfull width of the channel, while the “hook” occupies the center $\frac{1}{3}$.

Maximum velocity, shear stress, stream power and velocity gradients are decreased in the near-bank region and increased in the center of the channel. Sediment transport competence and capacity can be maintained as a result of the increased shear stress and stream power in the center $\frac{1}{3}$ of the channel. Backwater is created only in the near-bank region, and the small departure angle gently redirects the velocity vectors from the near-bank region, reducing active bank erosion.

The scour pool in the center $\frac{1}{3}$ of the channel provides energy dissipation and holding cover for fish. The flow separation zones, or “seams” of fast and slow water that mark the zones of downwelling and upwelling currents, are habitat features utilized by trout. The “hook” portion of the vane produces a longer, wider and deeper pool than that created by vane-only structures. The downstream pool dissipates energy and provides fish habitat. The $\frac{1}{4}$ - $\frac{1}{3}$ rock diameter gaps between the rocks associated with the hook creates a vortex or corkscrew flow that

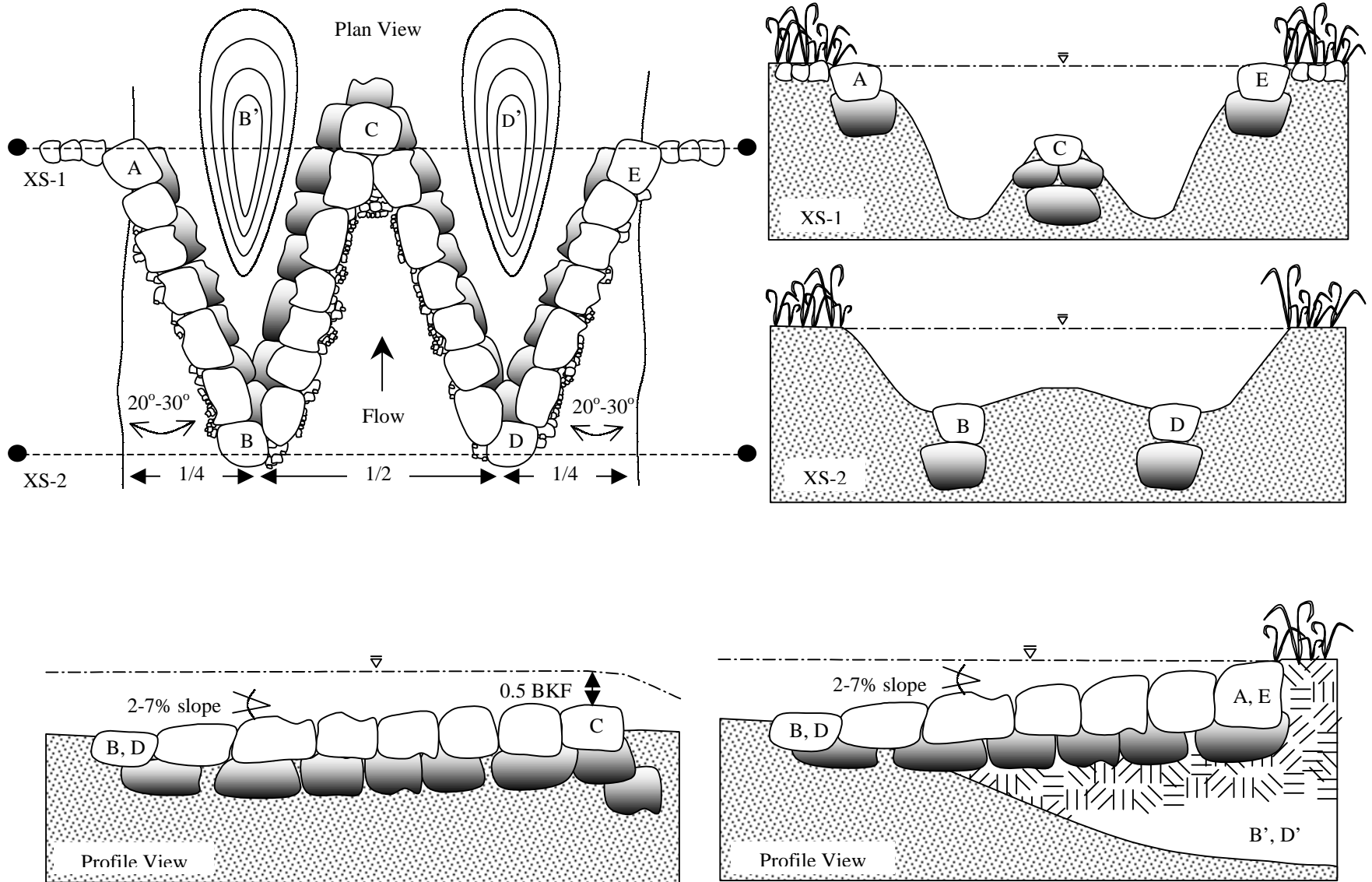

Figure 5. Plan, cross section, and profile views of the W-weir

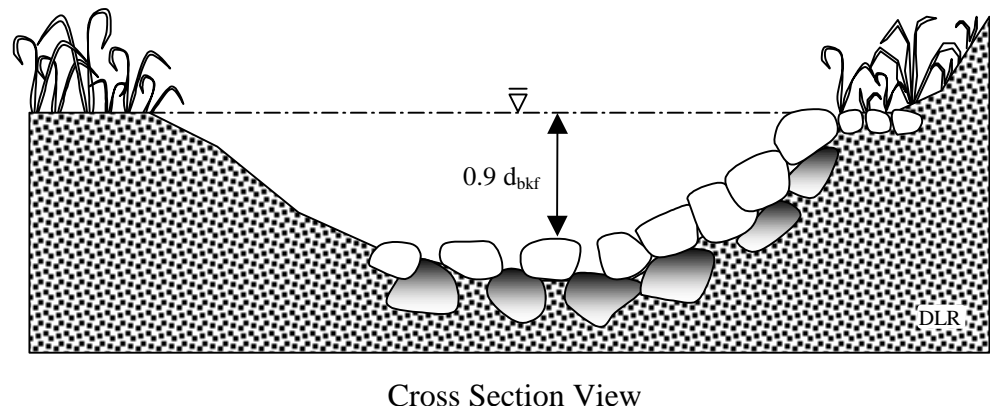
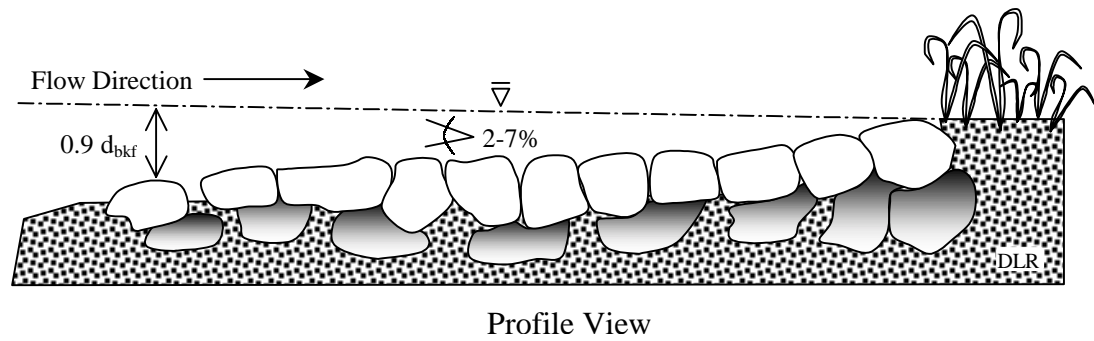
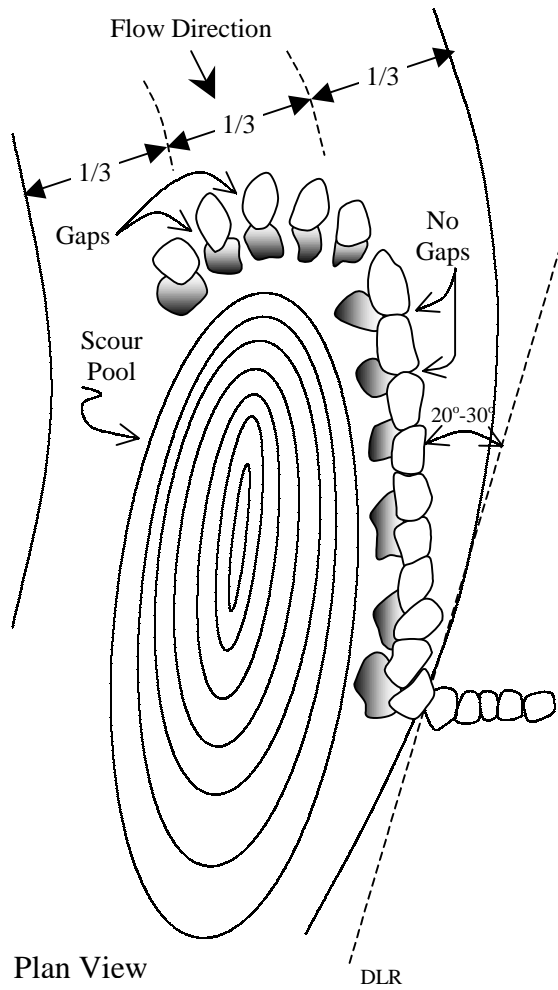

Figure 6. Plan, profile, and section view of the J-Hook Vane

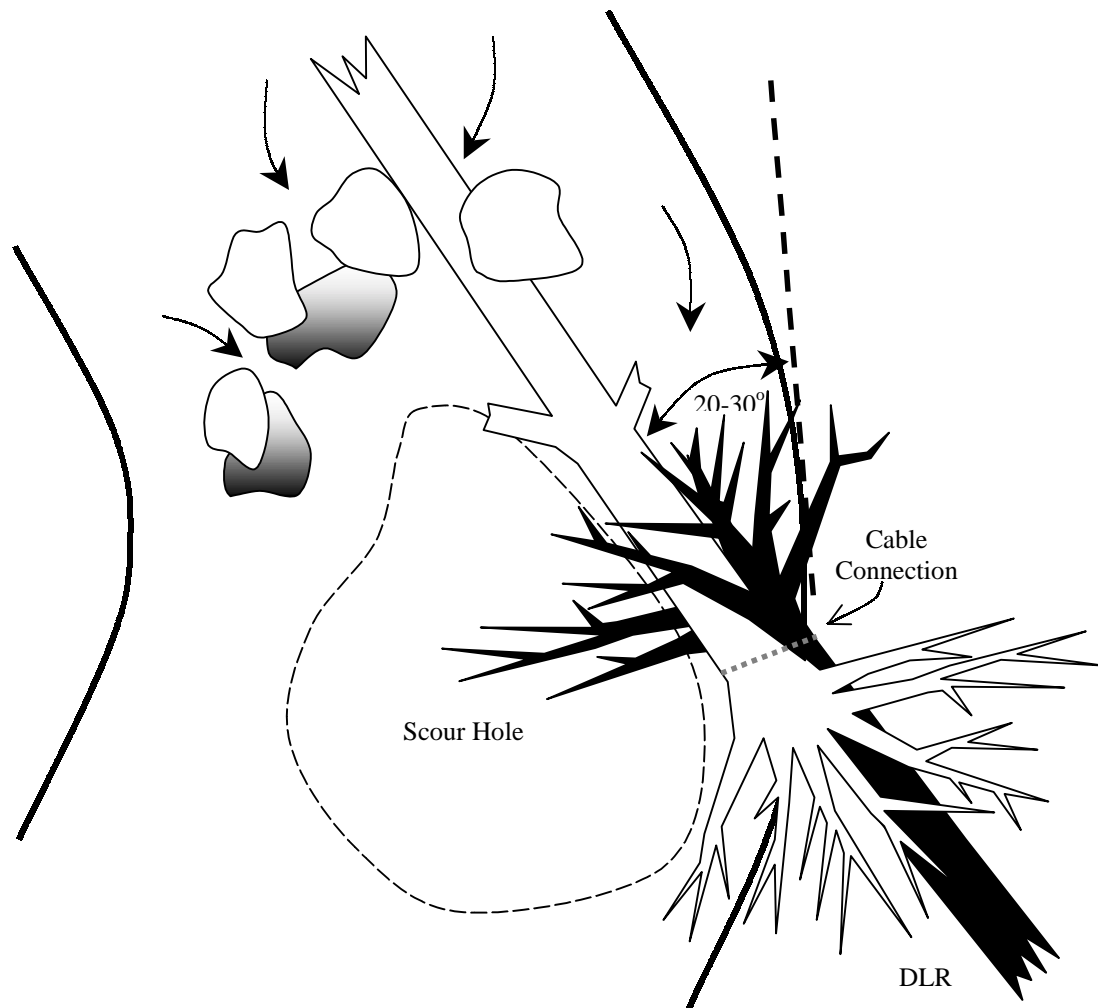

Figure 7. Root wad/log vane/J-Hook combo streambank stabilization and fish habitat structure

increases the “center-channel” shear stress. The center of the channel associated with the hook is efficient at transporting sediment, debris and improving channel capacity and sediment competence. The “shooting flow” associated with the hook portion of the structure provides for recreational boating in moderate to larger sized rivers. Width/depth ratios are maintained by decreasing bank erosion rate and increasing bankfull channel depth, even following major floods.

Design Specifications

Cross-Vanes, W-Weirs and J-Hook Vanes

Vane angle. The vane arm portion of all three structures is generally 20-30 degrees measured upstream from the tangent line where the vane intercepts the bank. The 20-degree angle provides the longest vane length and protects the greatest length of streambank. Variation from 20 to 30 degrees is often utilized in offset Cross-Vanes and/or W-Weirs whose asymmetry disproportionately shift more water to one side of the structure often used for irrigation

diversions. The flatter and smaller vane angle arm will extend farther upstream to intercept proportionately more water and increase the length of bank protected.

Vane slope. The slope of the vane extending from the bankfull stage bank should vary between 2-7 percent. Vane slope is defined by the ratio of bank height/vane length. For installation in meander bends, ratios of J-Hook Vane length/bankfull width is calculated as a function of the ratio of radius of curvature/bankfull width and departure angle (Table 1). Equations for predicting ratios of J-Hook Vane spacing/bankfull width on meander bends based on ratio of radius of curvature/bankfull width and departure angle is shown in Table 2. Vane length is the distance measured from the bankfull bank to the intercept with the invert elevation of the streambed at 1/3 of the bankfull channel width for either Cross-Vanes or J-Hook Vanes. For very large rivers, where it is impractical to extend the vane length to 1/3 of the bankfull width, vane slope is calculated based on the specified angle of departure and the ratio of bank height/vane length where the vane arm intercepts the proposed invert of the structure.

Table 1. Equations for predicting ratio of vane length/bankfull width (V_L) as a function of ratio of radius of curvature/width and departure angle, where W = bankfull width. (SI units)

Rc/W	Departure Angle (degrees)	Equation
3	20	$V_L = 0.0057 W + 0.9462$
3	30	$V_L = 0.0089 W + 0.5933$
5	20	$V_L = 0.0057 W + 1.0462$
5	30	$V_L = 0.0057 W + 0.8462$

Table 2. Equations for predicting ratio of vane spacing/width (V_s) as a function of ratio of radius of curvature/width and departure angle, where W = bankfull width (SI units)

Rc/W	Departure angle (degrees)	Equation
3	20	$V_s = - 0.006 W + 2.4781$
3	30	$V_s = - 0.0114 W + 1.9077$
5	20	$V_s = - 0.0057 W + 2.5538$
5	30	$V_s = - 0.0089 W + 2.2067$

The spacing of J-Hook Vanes can be increased by 0.40W if there exists a low bank erosion hazard rating (BEHI) of less than 30 (Rosgen, 1996, 2001).

Bank height. The structure should only extend to the bankfull stage elevation. If the bank is higher, a bankfull bench is constructed adjacent to the higher bank and the structure is integrated into the bench. The use of a Cross-Vane is shown in Figure 8 where a bankfull bench is created adjacent to a terrace bank.

Footers. The minimum footer depth at the invert for cobble and gravel bed streams is associated with a ratio of 3 times the protrusion height of the invert rock. This is applicable to all three structures and is shown in Figure 9 for a J-Hook Vane. For sand bed streams, the minimum depth is doubled due to the deeper scour depths that occur. All rocks for all three structures require footers. If spaces are left between the invert rocks for Cross-Vane and W Weirs, then the top of the footer rocks becomes the invert elevation for grade control. If no gaps are left, then the top of the surface rock becomes the base level of the stream.

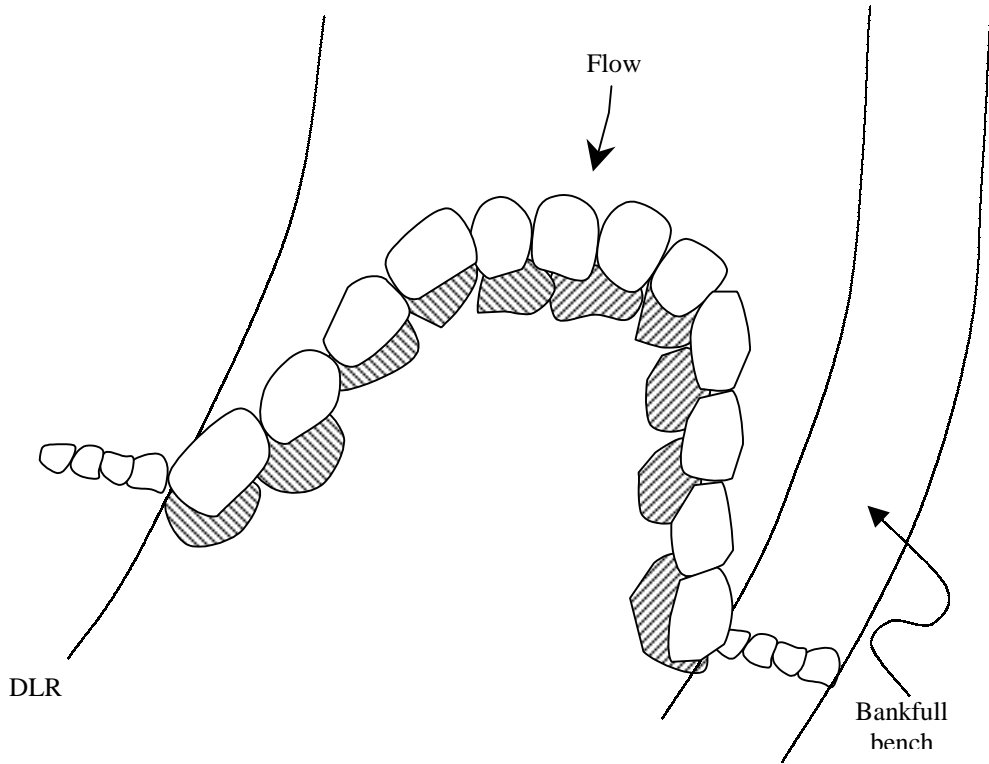
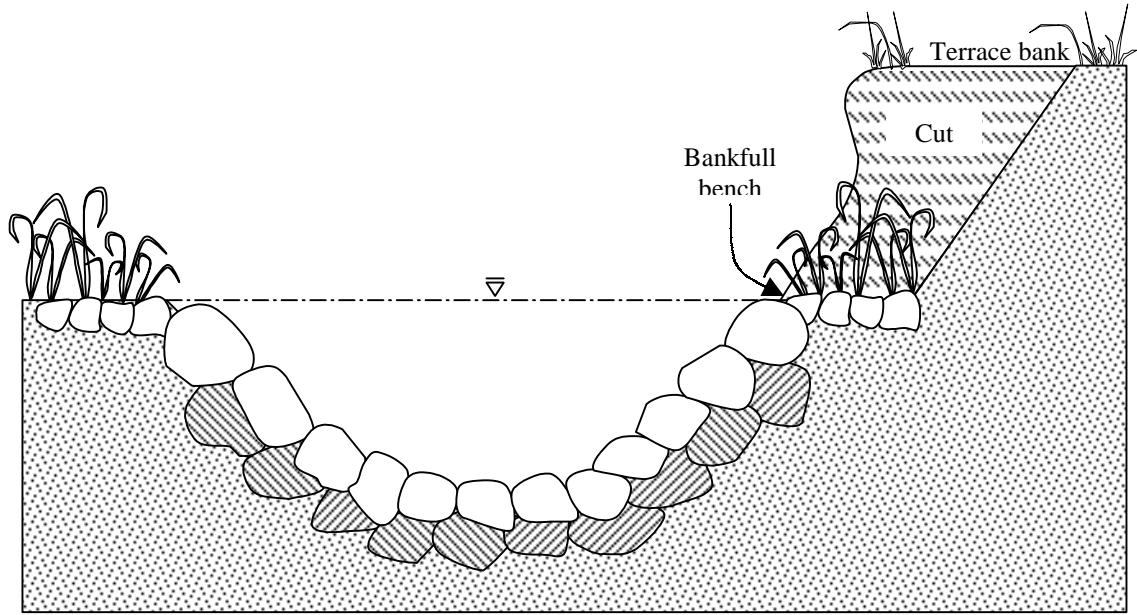

Figure 8. Example of a boulder Cross-Vane and constructed bankfull bench

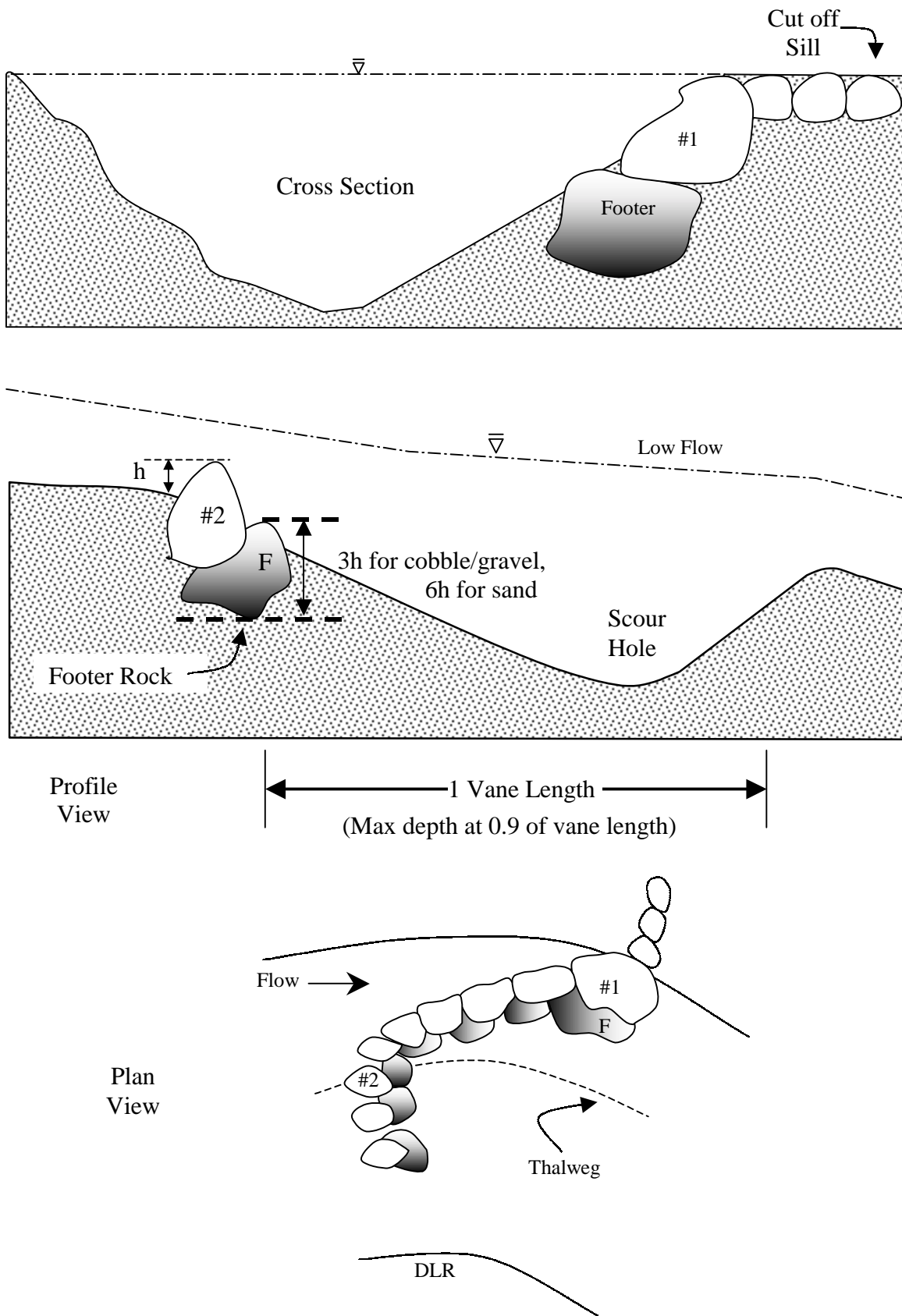

Figure 9. Locations/positions of rocks and footers in relation to channel shape and depths

Rock size. The relationship of bankfull shear stress to minimum rock size used for all three structures is shown in Figure 10. The application of this empirical relation is limited to size of rivers whose bankfull discharge varies from 0.56 cms (20 cfs) to 113.3 cms (4,000 cfs). For example, appropriate minimum rock sizes for values of bankfull shear stress less than 1.7 kg/m² (0.35lbs/ft²) are associated only with stream channel bankfull depths from 0.26 - 1.5m (2 - 5 ft). This relation would *not* be appropriate for applications outside the limits of the data for a river slope of 0.0003 and a mean depth of 6.1m, even though a similar shear stress results as in the example presented.

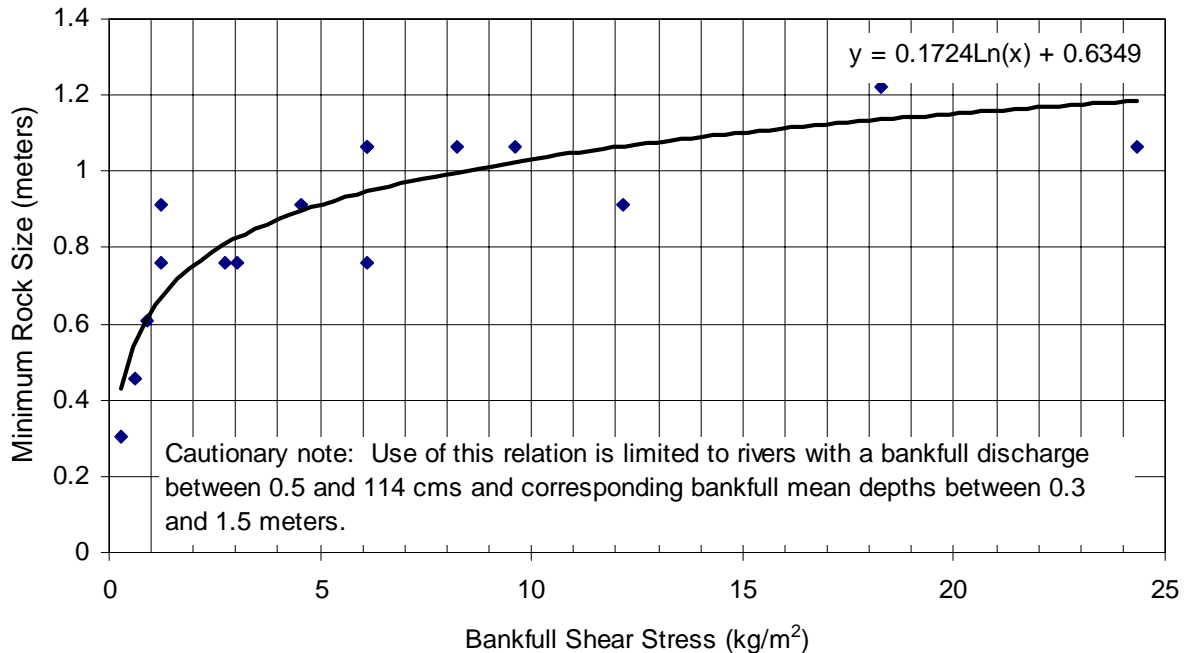

Figure 10. Minimum rock size as a function of bankfull shear stress

Materials. The Cross-Vane can be constructed with boulders, logs and a combination of both. A geotextile fabric is required to prevent scour under the structure when logs are used or when rocks are used in sand or silt/clay bed channels. The design using logs only and a duckbill anchor system is shown in Figure 11. Large flat rocks can be substituted for the duckbill anchor and cable to keep the logs in place.

Hydraulics. The center cell of Cross-Vane and J-Hook Vane structures generally contain 0.80 of the bankfull discharge. The left and right 1/3 cells of the structure each generally contain 0.3 of the mean velocity, 0.02 of the shear stress and 0.01 of the stream power of the entire bankfull channel. A velocity isovel showing the distribution of velocity over a J-Hook Vane on Turkey Creek, Colorado is shown in Figure 12. The Cross-Vane isovels are similar to those of the J-Hook Vane, as they distribute the velocity from the near-bank region to the center of the channel.

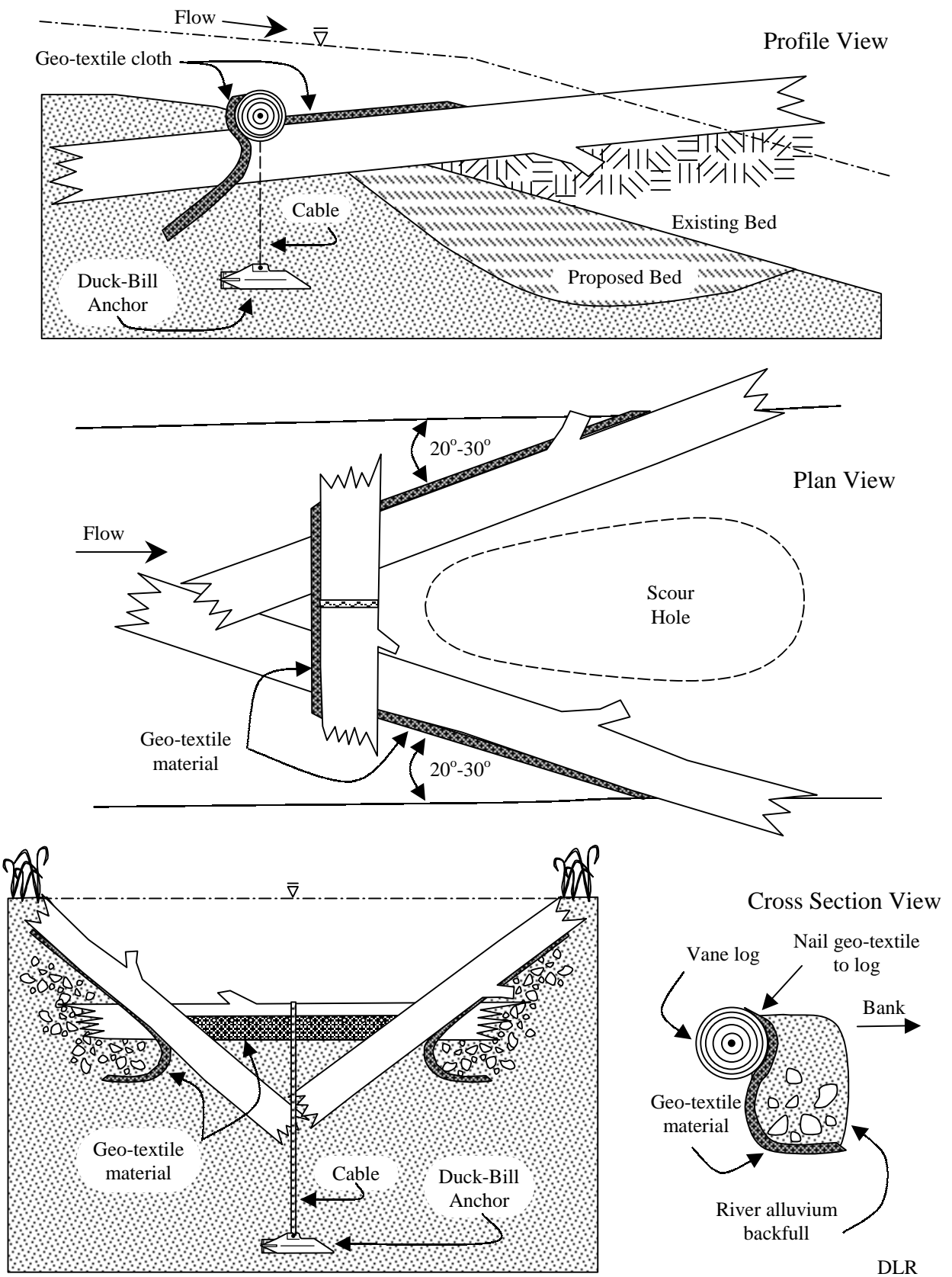

Figure 11. Cross-Vane using logs and a duck-bill anchor

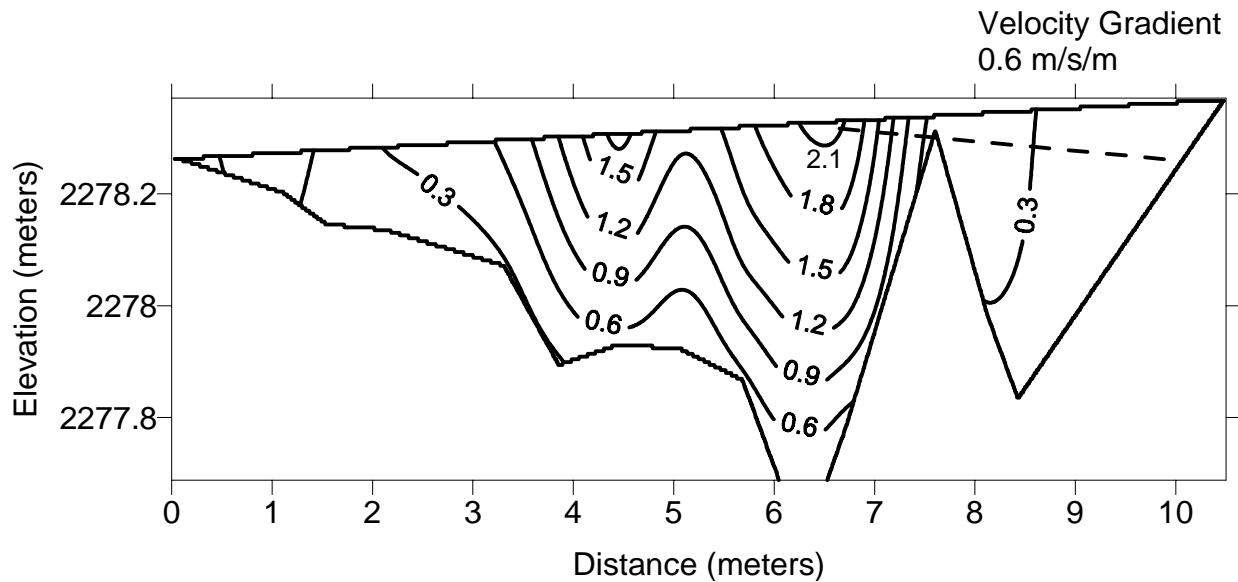

Figure 12. Velocity isovels of a J-Hook at Turkey Creek, CO (Velocity in meters/second)

Applications

Irrigation diversions. The use of a Cross-Vane for an irrigation diversion is shown in Figure 13. Cross-Vanes and W-Weirs have both been used successfully for irrigation structures. Both the Cross-Vane and W-Weir create a differential head in the near-bank region due to the flat slope of the vane leading to the bank. This condition provides the head to deliver water to the head gate at very low flows so that it is not necessary to construct sacrificial dams at low flows. When the head gate is closed during high flows, fine sediments often accumulate. To prevent the sediment deposition at the head gate and in the irrigation canal, a sediment sluice gate is installed so that the sediment is delivered back to the channel during normal high flows (Figure 13).

Grade control. The Cross-Vane is used to maintain base level in both riffle/pool channels, rapids-dominated stream types and in step-pool channels (Figure 14). One aspect of river restoration is associated with the conversion of incised rivers G and F stream types to B stream types (Rosgen, 1994, 1996, and 1997). The Cross-Vane, as used for grade control, maintains the new width/depth ratio, entrenchment ratio, reduces bank erosion, dissipates energy and improves fish habitat. Spacing of the structures is based on a negative power function relationship of the ratio of pool spacing / bankfull width as a function of slope.

$$P_s = 8.2513 S^{-0.9799}$$

Where P_s = the ratio of pool to pool spacing/bankfull width

S = channel slope in percent

This relationship was developed from natural channels and has a correlation coefficient (R^2) of 0.92 and is shown in Figure 15.

Bridge protection. Bridges constructed on a skew to the channel and/or placed on an outside bend often experience abutment scour and embankment erosion. This problem can be reduced by the placement of an offset Cross-Vane in the upstream reach. The vane on the outer bank in the bend has a flatter slope and smaller angle (20°), while the vane arm on the inside bank has a steeper slope and a larger angle (30°) (Figure 16). W-Weirs are particularly useful for reducing

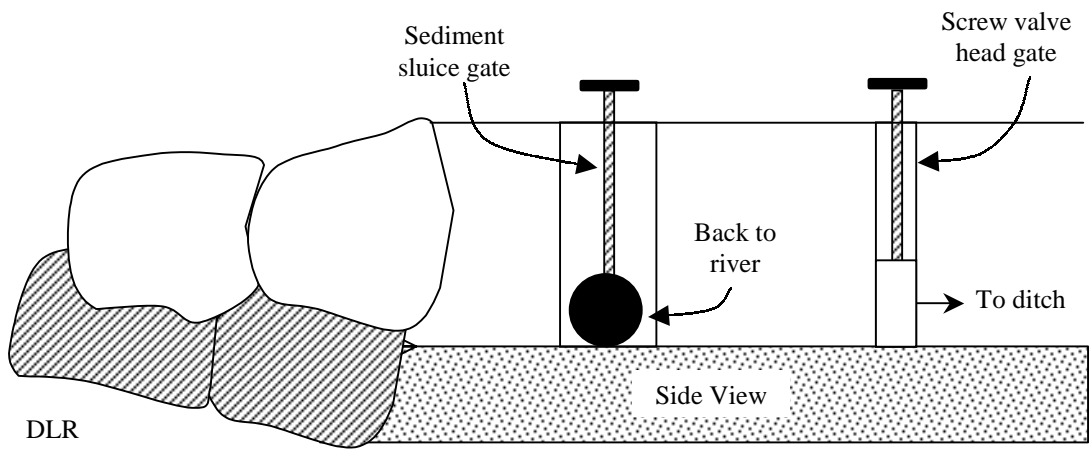
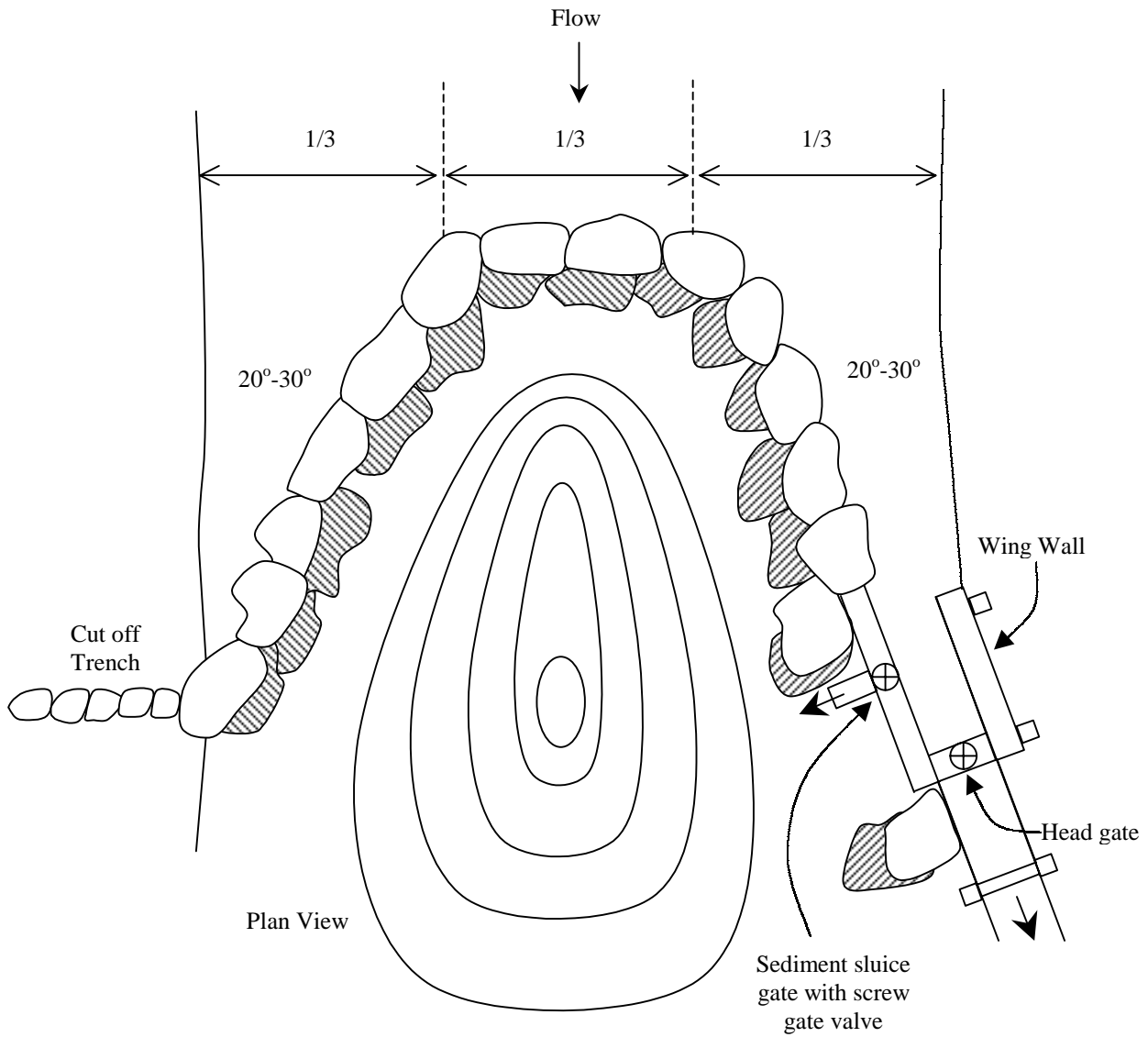

Figure 13. Example of a Cross-Vane/irrigation head gate-sediment sluice

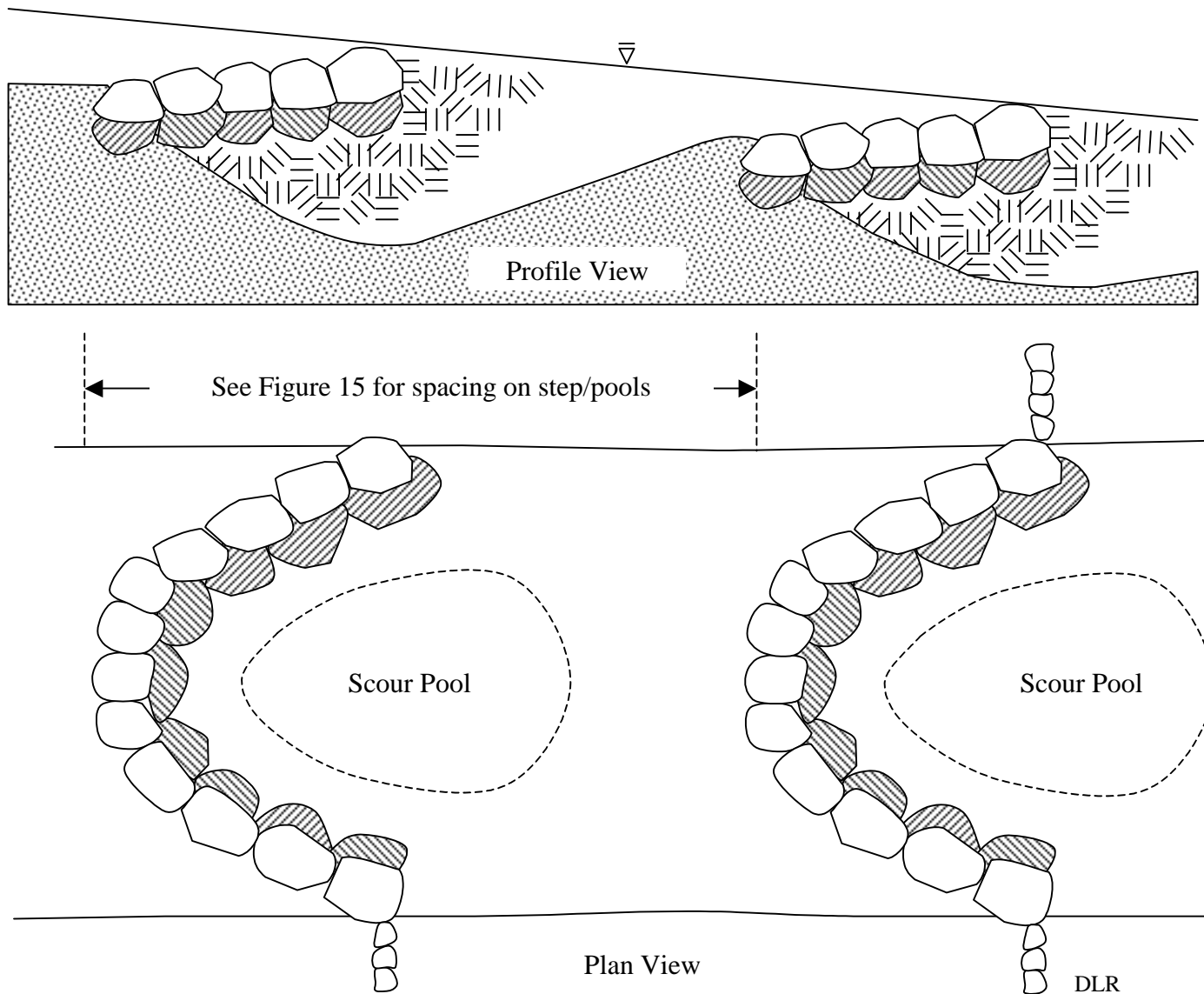

Figure 14. Use of Cross-Vane for step/pool restoration

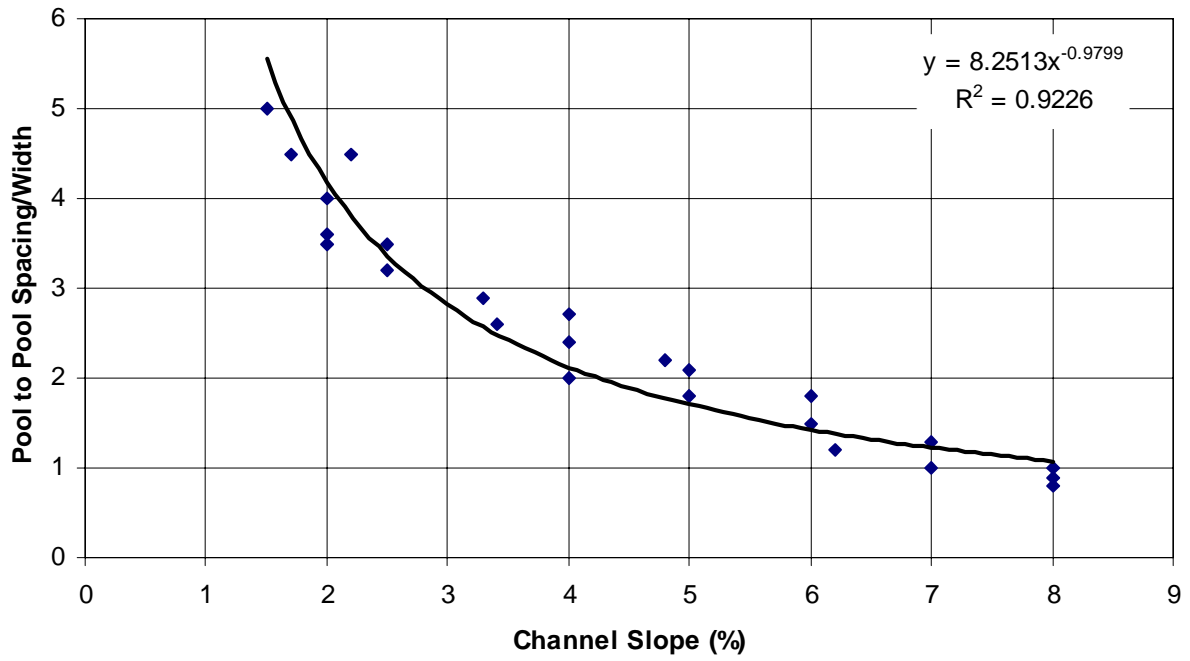

Figure 15. Ratio of pool spacing to bankfull width as a function of channel slope

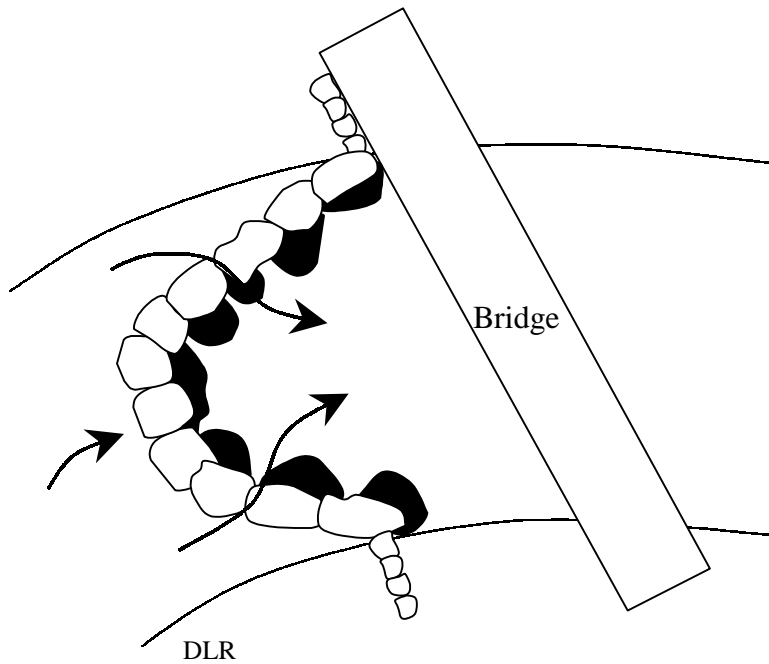

Figure 16. Application of a Cross-Vane for bridge and channel stability.

center pier scour. Both the Cross-Vane and W-Weir can provide grade control, prevent lateral migration of channels, eliminate fish migration barriers, increase sediment transport capacity and competence and reduce footer scour. J-Hook Vanes can reduce bank erosion on outside banks both for the approach and downstream reaches of the bridge.

Streambank stabilization. The J-Hook Vane is designed to reduce accelerated streambank erosion on the outside bend of meanders. As a minimum, the amount of bank protected is 2 times the vane length, while maximum spacing provides approximately 3 times the bank protection to vane length. If both banks are eroding due to confinement (lateral containment) and entrenchment (vertical containment), then the Cross-Vane decreases the stream power and shear stress concurrently on both banks. This avoids lining or hardening both banks through a reach to provide protection.

Summary

The Cross-Vane, W-Weir and J-Hook Vane are structures that can be implemented to maintain or enhance river stability and function to facilitate multiple objectives. These structures have been successfully applied in natural channel design for river restoration, bank stabilization, grade control, irrigation diversions, fish habitat enhancement, bridge protection, and recreational boating. Continued monitoring will provide the information necessary to improve the designs to further their application to meet the ever-increasing demand for environmentally “softer” structures that meet multiple objectives.

Acknowledgement. The author wishes to thank J.D. Kurz for computer assisted graphics and field assistance along with Art Parola, Jeremy Mondock and Jean Kapusnick for the Cross-Vane map in Figure 4, and to Dr. Richard Hey and Owen Williams for their thorough technical review of this manuscript.

Bibliography

- Bathurst, James C. 1979. Distribution of Boundary Shear Stress in Rivers. Adjustments of the Fluvial System. In Rhodes, Dallas D. and Garnett P. Williams (Eds.), Adjustments of the Fluvial System (pp. 95-116).
- Bathurst, James C., C. R. Thorne, and R. D. Hey. 1979. Secondary flow and shear stress at river bends. J. Hydr. Div. ASCE, 105(HY10), 1277-1295.
- Derrick, David L., Pokrefke, Thomas J., and Boyd, Marden, B., Crutfield, James P., Henderson, Raymond R. 1994. Design and Development of Bendway Weirs for the Dogtooth Bend Reach, Mississippi River, Technical Report HL-84-10, U.S. Army Corps of Engineers Waterways Experiment Station, Vicksburg, Mississippi.
- Derrick, David L. 1996. Harland Creek Innovative Bank Stabilization Demonstration Project. In 6th Federal Interagency Sedimentation Conference, March 10-14, Las Vegas, NV.
- Hey, R.D. 1992. River Mechanics and Habitat Creation. In: O’Grady, K.T.O., Butterworth A.J.B., Spillet, P.B. and Domainiewsky J.C.T., Fisheries in the year 2000, Institute of Fisheries Management, UK, 271-285.
- Ikeda, Syunsuke, Gary Parker, and Yoshitaka Kimura. 1988. Stable Width and Depth of

- Straight Gravel Rivers with Heterogeneous Bed Materials. *Water Resources Research* 24(5): 713-722.
- Leopold, L.B., G.M. Wolman, and J.P. Miller, 1964. *Fluvial Processes in Geomorphology* W.H. Freeman and Co. San Francisco 522pp.
- Odgaard A. J. and Mosconi C. E. 1987. Streambank protection by submerged vanes. *Journal of Hydraulic Engineering*. ASCE, 113(4), 520-536.
- Paice, Colin and Richard Hey. 1989. Hydraulic control of secondary circulation in a meander bend to reduce outer bank erosion. In Albertson, M.L. and Kia, R.A. (Eds.), *Design of Hydraulic Structures* 89. (pp. 249).
- Parker, G. 1978. Self-formed straight rivers with equilibrium banks and mobile bed, 2. *The gravel River, J. Fluid Mech.* 89(1), 127-146.
- Rosgen, David L. 1994. *A Classification of Natural Rivers*, *Catena* 22, pgs. 169-199, Elsevier Science B.V. Amsterdam
- Rosgen, David L. 1996. *Applied River Morphology*. Wildland Hydrology Books, Pagosa Springs, Colorado.
- Rosgen, David L. 1997. *A Geomorphological Approach to Restoration of Incised Rivers* In: *Management of Landscapes Disturbed by Channel Incision*, Univ. Miss, Oxford, Miss. Pg 3-22.
- Rosgen, David L. 1998. *The Reference Reach – A Blueprint for Natural Channel Design*. In *Proceedings of ASCE Specialty Conference on Restoration*, Denver, Colo.
- Rosgen, David L. 2001. *A Practical Method of Computing Streambank Erosion Rate*. In *7th Federal Interagency Sedimentation Conference*, March 25-29, Reno, NV.