

TYPE P

Aluminum Frame

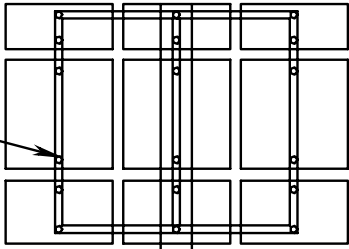

TYPE Q

Aluminum Frame

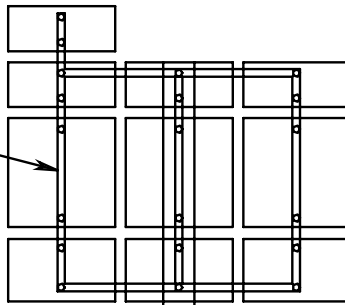

TYPE R

Aluminum Frame

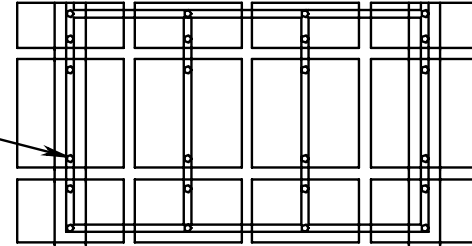

TYPE S

Type A Z Bars

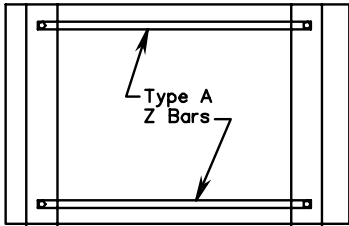

TYPE T

Aluminum Frame

Type A Z Bars

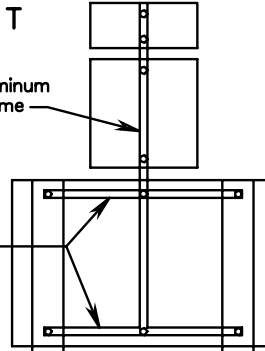

TYPE U

Aluminum Frame

Type A Z Bars

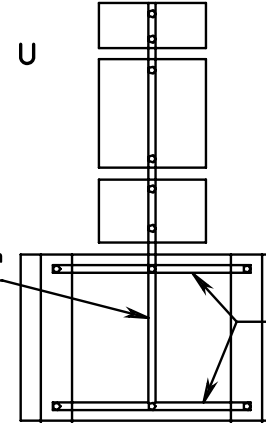

TYPE V

Aluminum Frame

Type A Z Bars

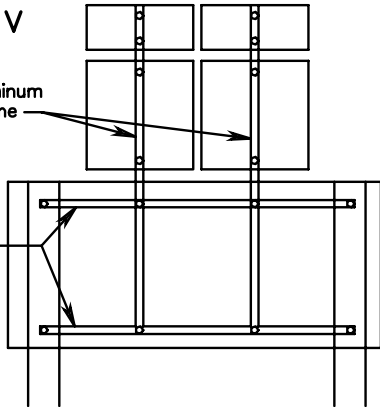

TYPE W

Type A Z Bars

Aluminum Frame

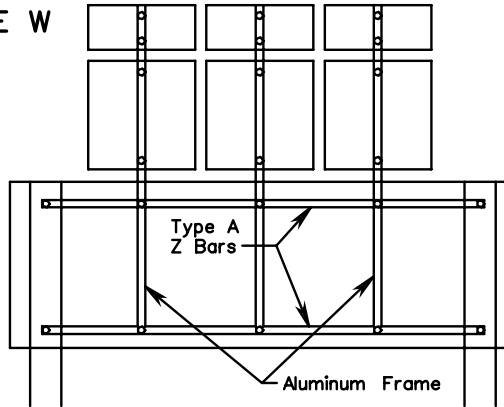

TYPE X

Assembly to be erected 5' from the nose of median and centered in median.

Curb face

Median

* 2' for medians over 10' in width. 12" for medians 10' or less in width.

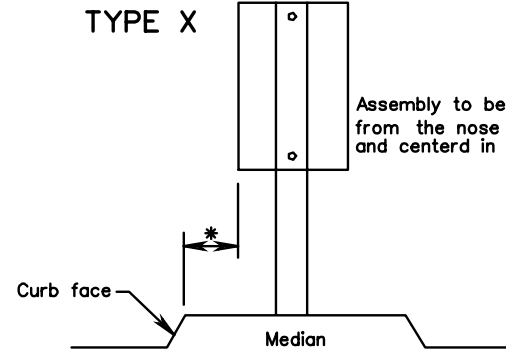

TYPICAL DETAILS FOR STANDARD WOOD POST STRUCTURE TYPES