

CHAPTER 4: PLAN DEVELOPMENT

4.1	SIGN PLAN SHEETS	1
4.2	SIGN PANEL SPECIAL DETAIL SHEETS	3
4.3	SIGN SCHEDULE	5
	4.3.1 Text Number.....	5
	4.3.1a Text.....	5
	4.3.2 Sign Number.....	6
	4.3.3 Sign Structure Standard.....	7
	4.3.4 Panel Size.....	7
	4.3.5 Letter Type/Fabrication.....	8
	4.3.6 Color Combination.....	8
	4.3.7 Standard Number.....	9
	4.3.8 Quantity.....	9
	4.3.9 Sign Area.....	10
	4.3.10 Remarks.....	10
4.4	WOOD POST STRUCTURE CALCULATIONS	11
4.5	TYPE VA SIGN STRUCTURE DETAIL	12
4.6	TYPE VIA SIGN STRUCTURE DETAIL	13
	4.6.1 Width Discrepancy.....	14
	4.6.2 Height Discrepancy.....	15
	4.6.3 Width and Height Discrepancies.....	15
	4.6.4 Alternate Attachment Method.....	16
4.7	OVERHEAD (O/H) SIGN STRUCTURE ELEVATION DETAIL SHEET	17
4.8	NOTES FOR SAFETY IMPROVEMENT ITEMS SHEET	20
4.9	EXIT NUMBER SIGN PANELS DETAILS	22
	4.9.1 Typical details for exit number sign panels.....	22
	4.9.2 Exit Number Sign Panel Sizes.....	23
	4.9.3 Interstate Arrows.....	24
4.10	SUMMARY OF QUANTITIES SHEET	24
4.11	TITLE SHEET	25

4.1 SIGN PLAN SHEETS

Develop sign alignment base plans in accordance with the CADD Manual, Chapter 4. Pertinent information to be included is referenced in the Sign Alignment Base Plan Checklist located in [Appendix IIB-1](#).

Design directives received during the preliminary sign plan meeting with the district and / or other agencies can be placed on the sign alignment base plans as shown and in [Appendix IIA-3](#).

When indicating “standard” proposed signs, use the cell libraries found in the CADD Manual. For “Special” proposed signs, use the sign figure details developed by the Guide Sign program.

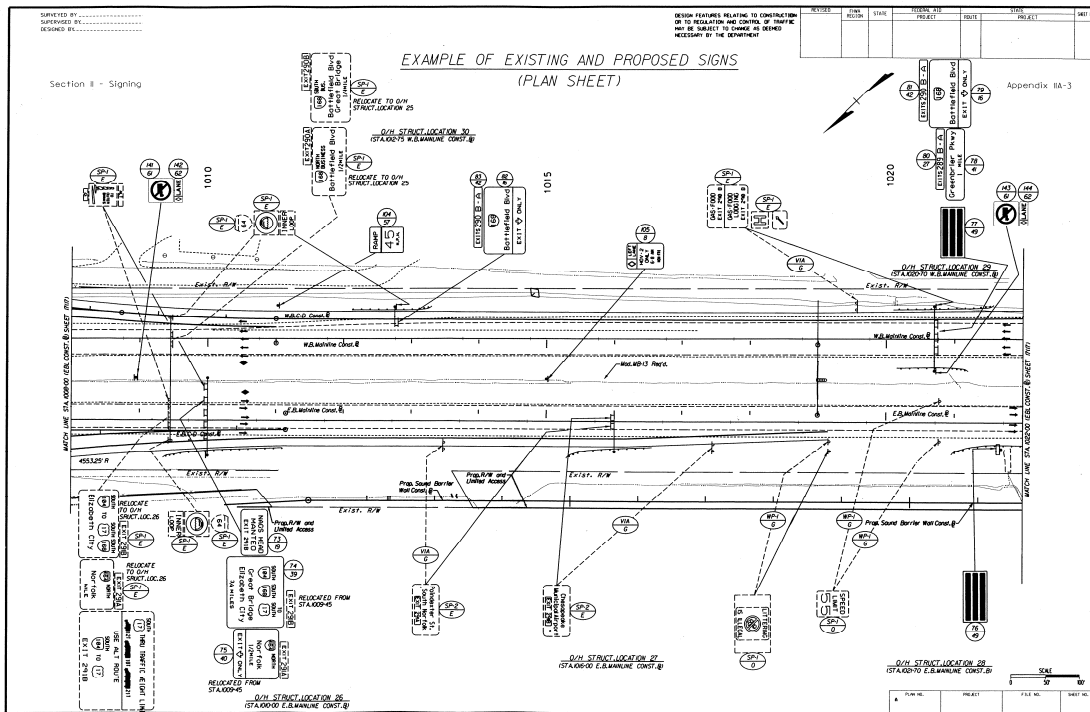

EXAMPLE OF EXISTING AND PROPOSED SIGN PLAN SHEET
 (See Appendix IIA-3)

This plan sheet illustrates an example of depicting and labeling existing and proposed signs on the base plan sheet.

All labeling should read from left to right and top to bottom. The sign plan sheet should indicate the sign and text numbers, the symbol for location of the structure and the message to be displayed on the sign. The sign plan sheet also illustrates existing signs with their messages and structures, and identifies what actions are to be taken during construction (i.e. ellipse method).

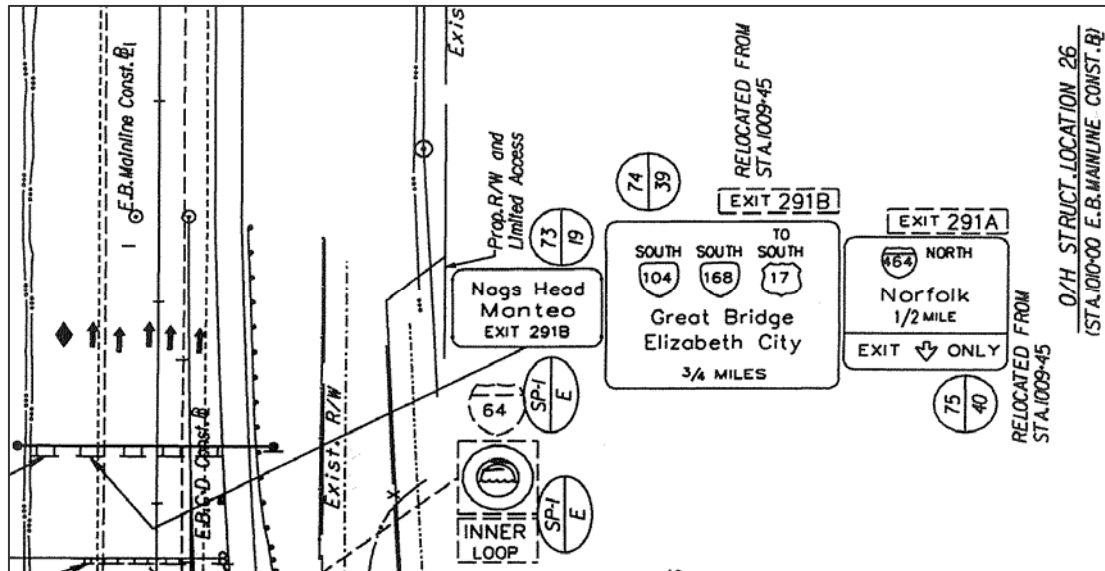

Figure 4-1: LABELING FOR EXISTING AND PROPOSED SIGNS

- Existing signs are identified by dashed lines with an ellipse symbol. The top half of the ellipse provides information identifying the type of existing sign structure and the bottom half identifies the measurement and payment for the sign, as shown in Figure 4-1. Further detailed information regarding the sign labeling is provided in [Appendix IIA-9](#), “Notes For Safety Improvement Items”.
- Proposed signs are identified by solid lines with a circle symbol. The top half of the circle identifies the sign number and the bottom half of the circle identifies the text number, as shown in Figure 4-1. Detailed information regarding sign numbers and text numbers are illustrated in [Appendix IIA-6](#) or [IIA-7](#). Discussion regarding the method of assigning sign and text numbers are presented in Subsection 4.3.1.

4.2 SIGN PANEL SPECIAL DETAIL SHEETS

Prepare Sign Panel Special Details, as shown in [Appendix IIA-4](#) and [IIA-5](#).

- All guide signs shall be designed and fabricated utilizing the “Clearview Highway Font” as is indicated in Traffic Engineering Memorandum TE-337. (See Appendix 11B-51).
- All special and Non-Standard signs indicated in the Sign Schedule require a Sign Figure Detail. After determining the appropriate letter size, spacing and margin from the MUTCD, Standard Highway Signs Manual or the Virginia Supplement to the MUTCD, the values are inserted into the GUIDSIGN software program to generate the detail, as shown in Figure 4-2. The values can be modified by the designer to accommodate sign sizing.
- The overall sign panel size dimensions from GUIDSIGN need to provide a dimension divisible by six, to be in accordance with VDOT Standards.
- If Logo Signs are included in the plans, it will be necessary to include insertable sheets for Logo Signing with guidance and input from the State Signing Programs Section.

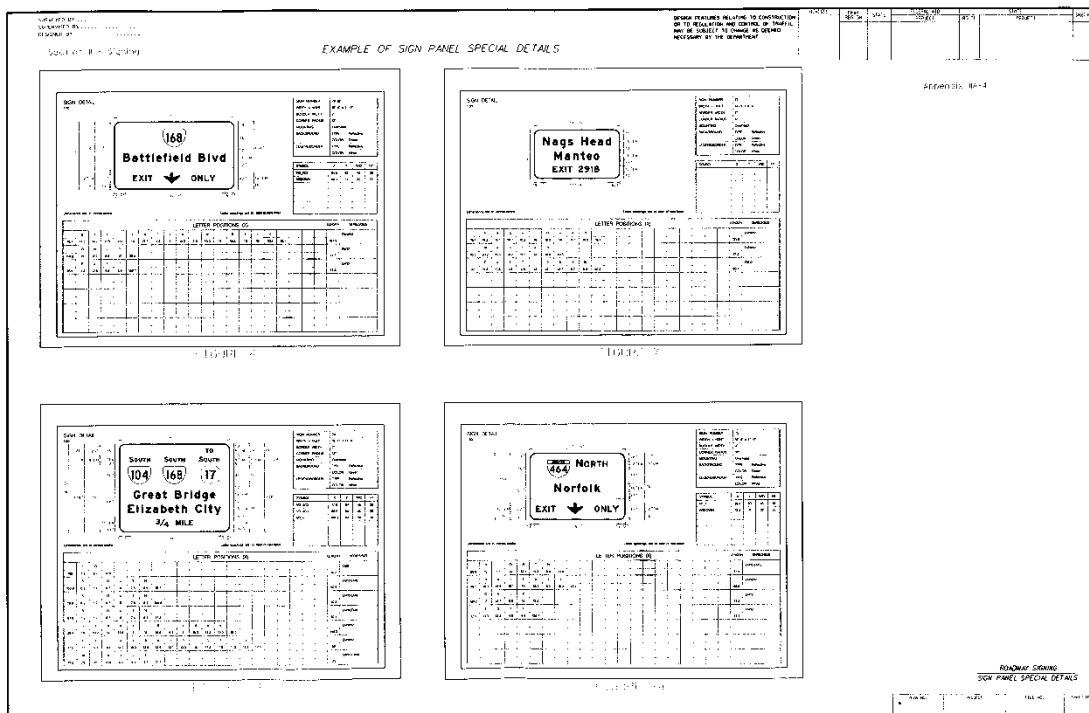

**EXAMPLE OF SIGN PANEL SPECIAL DETAILS
(See Appendix IIA-4)**

Sign Panel Special Detail sheets, designed by the GUIDSIGN program, provide sign dimensions and letter positions for sign fabrication on all non-standard signs. Several Sign Figure Details, as shown in Figure 4-2, can be placed on a Sign Panel Special Detail sheet. All sign details and dimensions shall be clearly legible for all sign size reproduction.

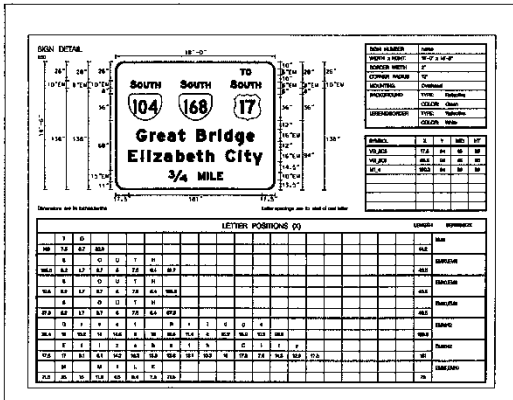

FIGURE 23

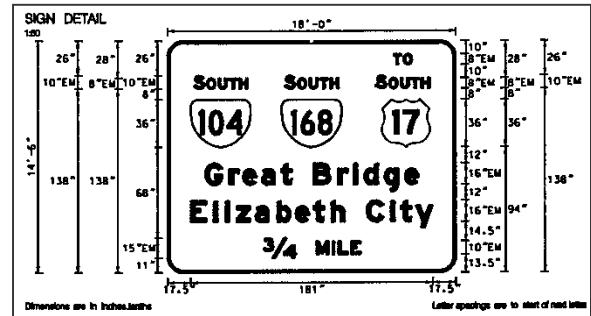

Figure 4-2: SIGN DETAIL (Enlarged View)

Figure 4-2: SIGN PANEL SPECIAL DETAIL

4.3 SIGN SCHEDULE











Prepare the Sign Schedule, as shown in [Appendix IIA-6](#) or [IIA-7](#).

EXAMPLE OF A SIGN SCHEDULE

DESIGN FEATURES RELATING TO CONSTRUCTION OR TO REGULATION AND CONTROL OF TRAFFIC MAY BE SUBJECT TO CHANGE AS NECESSARY BY THE DEPARTMENT

Section II - Signing

Appendix IIA-6

TEXT NO.	TEXT	SIGN NO.	SIGN STRUCT. STD.	PANEL SIZE IN FT. - IN.	LETTERS TYPE	COLOR COMB.	STD. NO.	TEXT NO.	REMARKS
8		4155.5816.05	MSW	3'0" x 4'0"	U	C5 C7	SPECIAL	5	4- MEDIUM BARRIER MOUNTED 10- MEDIUM BARRIER MOUNTED 20- MEDIUM BARRIER MOUNTED 30- MEDIUM BARRIER MOUNTED 40- MEDIUM BARRIER MOUNTED FIGURE 4
16		11.06.78.02	D/H LOC. 4 D/H LOC. 5 D/H LOC. 26	8'0" x 8'0"	P 0	L3 C7 C8	SPECIAL	4	2MS FIGURE 7
19		25.32.73	D/H LOC. 4 D/H LOC. 5 D/H LOC. 26	8'0" x 8'0"	L3	C7	SPECIAL	3	MS FIGURE 35
27		41.00	D/H LOC. 26 D/H LOC. 25	2'0" x 2'0"	L3	C7	SPECIAL	2	30 FIGURE 23
39		74	D/H LOC. 26 D/H LOC. 25	8'0" x 8'0"	L3	C7	SPECIAL	1	26 FIGURE 24
40		75	D/H LOC. 26 D/H LOC. 25	17'0" x 17'0"	C7 C8		SPECIAL	1	20925
4		78	D/H LOC. 26 D/H LOC. 25	5'0" x 5'0"	L3	C7	SPECIAL	1	10215 FIGURE 25
42		0.83.07.9.06	D/H LOC. 26 D/H LOC. 25 D/H LOC. 35	2'0" x 2'0"	L3	C7	SPECIAL	5	30 FIGURE 37
43		30.76.77	D/H LOC. 4 D/H LOC. 5 D/H LOC. 26	8'0" x 7'0"			SPECIAL	1	000 VMS TYPE 'B' - FLIP DISK WITH LED FIGURE 44
57		04	VAC	4'0" x 5'0"	U	C8	MS-3	1	20

EXAMPLE OF A SIGN SCHEDULE
(See Appendix IIA-6)

A Sign Schedule sheet provides detailed information about all signs to be installed on the project. The following subsections will discuss the data needed on the Sign Schedule. To illustrate and detail the information shown on the Sign Schedule, Sign No. 74 in [Appendix IIA-6](#) will be used as an example.

4.3.1 Text Number

The sign text number column, as shown in Figure 4-3, is determined by numbering the sign text from one through the number of signs, or grouping of signs, illustrated in the text column. Signs or grouping of signs that are alike should have the same text number. The text numbers shall match the bottom half of the circle of the signs on the plan sheet(s) for which it applies.

It is also desirable to arrange the signs in the following order: Regulatory signs, Warning signs, Guide signs. It is recommended to use the Standard Highway Signs Book when determining the type and order of signs to be presented on the Sign Schedule.

4.3.1a Text

The text column, as shown in Figure 4-3, illustrates a graphic view of the sign and message.





TEXT NO.	TEXT	SIGN NO.	SIGN STRUCT. STD.	PANEL SIZE IN FT - IN		LETTER TYPE	COLOR COMB.	STD. NO.	QUANTITY	SIGN AREA SQ. FT. EA.	REMARKS
				W	H						
8		41,55,58,68,105	MBM	3'-0"	4'-0"	L1	C-15 C-1	SPECIAL	5	12	41 - MEDIUM BARRIER MOUNTED 55 - MEDIUM BARRIER MOUNTED 58 - MEDIUM BARRIER MOUNTED 68 - MEDIUM BARRIER MOUNTED 105 - MEDIUM BARRIER MOUNTED FIGURE 41
16		13,18,79,82	O/H LOC. 4 O/H LOC. 5 O/H LOC. 29 O/H LOC. 30	19'-6"	11'-0"	L3	C-7 C-8	SPECIAL	4	2145	FIGURE 4
19		25,37,73	O/H LOC. 6 O/H LOC. 10 O/H LOC. 26	14'-0"	8'-0"	L3	C-7	SPECIAL	3	112	FIGURE 7
27		43,80	O/H LOC. 12 O/H LOC. 29	15'-0"	2'-0"	L3	C-7	SPECIAL	2	30	FIGURE 35
39		74	O/H LOC. 26	18'-0"	14'-6"	L3	C-7	SPECIAL	1	261	FIGURE 23

Figure 4-3: TEXT NUMBER and TEXT (Highlighted)

4.3.2 Sign Number

The sign number column, as shown in Figure 4-4, is determined by numbering the signs starting on the first sheet of the sign plans and progressing through the plans. The sign number shall match the top half of the circle of the signs on the plan sheet(s) for which it applies.







TEXT NO.	TEXT	SIGN NO.	SIGN STRUCT. STD.	PANEL SIZE IN FT - IN		LETTER TYPE	COLOR COMB.	STD. NO.	QUANTITY	SIGN AREA SQ. FT. EA.	REMARKS
				W	H						
8		41,55,58,68,105	MBM	3'-0"	4'-0"	L1	C-15 C-1	SPECIAL	5	12	41 - MEDIUM BARRIER MOUNTED 55 - MEDIUM BARRIER MOUNTED 58 - MEDIUM BARRIER MOUNTED 68 - MEDIUM BARRIER MOUNTED 105 - MEDIUM BARRIER MOUNTED FIGURE 41
16		13,18,79,82	O/H LOC. 4 O/H LOC. 5 O/H LOC. 29 O/H LOC. 30	19'-6"	11'-0"	L3	C-7 C-8	SPECIAL	4	2145	FIGURE 4
19		25,37,73	O/H LOC. 6 O/H LOC. 10 O/H LOC. 26	14'-0"	8'-0"	L3	C-7	SPECIAL	3	112	FIGURE 7
27		43,80	O/H LOC. 12 O/H LOC. 29	15'-0"	2'-0"	L3	C-7	SPECIAL	2	30	FIGURE 35
39		74	O/H LOC. 26	18'-0"	14'-6"	L3	C-7	SPECIAL	1	261	FIGURE 23

Figure 4-4: SIGN NUMBER (Highlighted)

4.3.3 Sign Structure Standard

The sign structure standard column, as shown in Figure 4-5, identifies the type of structure [i.e. Overhead, Type VA, Type VIA, steel or wood (size and type)].

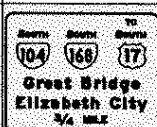







TEXT NO.	TEXT	SIGN NO.	SIGN STRUCT. STD.	PANEL SIZE IN FT - IN		LETTER TYPE	COLOR COMB.	STD. NO.	QUANTITY	SIGN AREA SQ. FT. EA	REMARKS
				W	H						
8		41,55,58,60,05	MBM	3'-0"	4'-0"	L1	C-15 C-1	SPECIAL	5	12	41 - MEDIAN BARRIER MOUNTED 55 - MEDIAN BARRIER MOUNTED 58 - MEDIAN BARRIER MOUNTED 68 - MEDIAN BARRIER MOUNTED 05 - MEDIAN BARRIER MOUNTED FIGURE 41
16		13,18,79,82	O/H LOC.4 O/H LOC.5 O/H LOC.29 O/H LOC.30	19'-6"	11'-0"	L3	C-7 C-8	SPECIAL	4	2145	FIGURE 4
19		25,37,73	O/H LOC.6 O/H LOC.10 O/H LOC.26	14'-0"	8'-0"	L3	C-7	SPECIAL	3	112	FIGURE 7
27		43,80	O/H LOC.12 O/H LOC.29	15'-0"	2'-0"	L3	C-7	SPECIAL	2	30	FIGURE 35
39		74	O/H LOC.26	18'-0"	14'-6"	L3	C-7	SPECIAL	1	261	FIGURE 23

Figure 4-5: SIGN STRUCTURE STANDARD (Highlighted)

4.3.4 Panel Size

The panel size column, as shown in Figure 4-6, is determined from the GUIDSIGN Software Program, Standard Highway Signs Manual, MUTCD, or the Virginia supplement to the MUTCD.

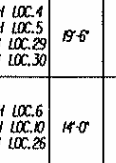





TEXT NO.	TEXT	SIGN NO.	SIGN STRUCT. STD.	PANEL SIZE IN FT - IN		LETTER TYPE	COLOR COMB.	STD. NO.	QUANTITY	SIGN AREA SQ. FT. EA	REMARKS
				W	H						
8		41,55,58,60,05	MBM	3'-0"	4'-0"	L1	C-15 C-1	SPECIAL	5	12	41 - MEDIAN BARRIER MOUNTED 55 - MEDIAN BARRIER MOUNTED 58 - MEDIAN BARRIER MOUNTED 68 - MEDIAN BARRIER MOUNTED 05 - MEDIAN BARRIER MOUNTED FIGURE 41
16		13,18,79,82	O/H LOC.4 O/H LOC.5 O/H LOC.29 O/H LOC.30	19'-6"	11'-0"	L3	C-7 C-8	SPECIAL	4	2145	FIGURE 4
19		25,37,73	O/H LOC.6 O/H LOC.10 O/H LOC.26	14'-0"	8'-0"	L3	C-7	SPECIAL	3	112	FIGURE 7
27		43,80	O/H LOC.12 O/H LOC.29	15'-0"	2'-0"	L3	C-7	SPECIAL	2	30	FIGURE 35
39		74	O/H LOC.26	18'-0"	14'-6"	L3	C-7	SPECIAL	1	261	FIGURE 23

Figure 4-6: PANEL SIZE (Highlighted)

4.3.5 Letter Type/Fabrication

The sign lettering type and fabrication column, as shown in Figure 4-7, is determined from the [VDOT Road and Bridge Specifications, Section 701 - Traffic Signs](#).



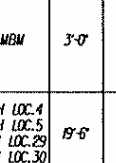

TEXT NO.	TEXT	SIGN NO.	SIGN STRUCT. STD.	PANEL SIZE IN FT - IN		LETTER TYPE	COLOR COMB.	STD. NO.	QUANTITY	SIGN AREA SQ. FT. EA.	REMARKS
				W	H						
8		41,55,58,68,105	MBM	3'-0"	4'-0"	L1	C-15 C-1	SPECIAL	5	12	41 - MEDIAN BARRIER MOUNTED 55 - MEDIAN BARRIER MOUNTED 58 - MEDIAN BARRIER MOUNTED 68 - MEDIAN BARRIER MOUNTED 105 - MEDIAN BARRIER MOUNTED FIGURE 41
16		13,18,79,82	O/H LOC. 4 O/H LOC. 5 O/H LOC. 29 O/H LOC. 30	19'-6"	11'-0"	L3	C-7 C-8	SPECIAL	4	2145	FIGURE 4
19		25,37,73	O/H LOC. 6 O/H LOC. 10 O/H LOC. 26	14'-0"	8'-0"	L3	C-7	SPECIAL	3	112	FIGURE 7
27		43,80	O/H LOC. 12 O/H LOC. 29	15'-0"	2'-0"	L3	C-7	SPECIAL	2	30	FIGURE 35
39		74	O/H LOC. 26	18'-0"	14'-6"	L3	C-7	SPECIAL	1	261	FIGURE 23

Figure 4-7: LETTER TYPE / FABRICATION (Highlighted)

4.3.6 Color Combination

The color combination column, as shown in Figure 4-8, is determined from the MUTCD and the Color Code Chart found in [Appendix IIB-17](#).





TEXT NO.	TEXT	SIGN NO.	SIGN STRUCT. STD.	PANEL SIZE IN FT - IN		LETTER TYPE	COLOR COMB.	STD. NO.	QUANTITY	SIGN AREA SQ. FT. EA.	REMARKS
				W	H						
8		41,55,58,68,105	MBM	3'-0"	4'-0"	L1	C-15 C-1	SPECIAL	5	12	41 - MEDIAN BARRIER MOUNTED 55 - MEDIAN BARRIER MOUNTED 58 - MEDIAN BARRIER MOUNTED 68 - MEDIAN BARRIER MOUNTED 105 - MEDIAN BARRIER MOUNTED FIGURE 41
16		13,18,79,82	O/H LOC. 4 O/H LOC. 5 O/H LOC. 29 O/H LOC. 30	19'-6"	11'-0"	L3	C-7 C-8	SPECIAL	4	2145	FIGURE 4
19		25,37,73	O/H LOC. 6 O/H LOC. 10 O/H LOC. 26	14'-0"	8'-0"	L3	C-7	SPECIAL	3	112	FIGURE 7
27		43,80	O/H LOC. 12 O/H LOC. 29	15'-0"	2'-0"	L3	C-7	SPECIAL	2	30	FIGURE 35
39		74	O/H LOC. 26	18'-0"	14'-6"	L3	C-7	SPECIAL	1	261	FIGURE 23

Figure 4-8: COLOR COMBINATION (Highlighted)

4.3.7 Standard Number

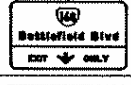
The standard number column, as shown in Figure 4-9, is derived from the MUTCD, Standard Highway Signs Manual or the Virginia Supplement to the MUTCD. If a standard number is not applicable, the word “SPECIAL” is indicated.

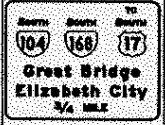







TEXT NO.	TEXT	SIGN NO.	SIGN STRUCT. STD.	PANEL SIZE IN FT - IN		LETTER TYPE	COLOR COMB.	STD. NO.	QUANTITY	SIGN AREA SQ. FT. EA	REMARKS
				W	H						
8		41,55,58,68,105	MBM	3'-0"	4'-0"	L1	C-15 C-1	SPECIAL	5	12	41 - MEDIAN BARRIER MOUNTED 55 - MEDIAN BARRIER MOUNTED 58 - MEDIAN BARRIER MOUNTED 68 - MEDIAN BARRIER MOUNTED 105 - MEDIAN BARRIER MOUNTED FIGURE 41
16		13,18,79,82	O/H LOC. 4 O/H LOC. 5 O/H LOC. 29 O/H LOC. 30	19'-6"	11'-0"	L3	C-7 C-8	SPECIAL	4	2145	FIGURE 4
19		25,37,73	O/H LOC. 6 O/H LOC. 10 O/H LOC. 26	14'-0"	8'-0"	L3	C-7	SPECIAL	3	112	FIGURE 7
27		43,80	O/H LOC. 12 O/H LOC. 29	15'-0"	2'-0"	L3	C-7	SPECIAL	2	30	FIGURE 35
39		74	O/H LOC. 26	18'-0"	14'-6"	L3	C-7	SPECIAL	1	261	FIGURE 23

Figure 4-9: STANDARD NUMBER (Highlighted)

4.3.8 Quantity

The quantity column for each sign or grouping of signs of each text No. for the entire plan set is determined and identified in the Sign Schedule, as shown in Figure 4-10.

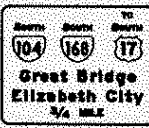







TEXT NO.	TEXT	SIGN NO.	SIGN STRUCT. STD.	PANEL SIZE IN FT - IN		LETTER TYPE	COLOR COMB.	STD. NO.	QUANTITY	SIGN AREA SQ. FT. EA	REMARKS
				W	H						
8		41,55,58,68,105	MBM	3'-0"	4'-0"	L1	C-15 C-1	SPECIAL	5	12	41 - MEDIAN BARRIER MOUNTED 55 - MEDIAN BARRIER MOUNTED 58 - MEDIAN BARRIER MOUNTED 68 - MEDIAN BARRIER MOUNTED 105 - MEDIAN BARRIER MOUNTED FIGURE 41
16		13,18,79,82	O/H LOC. 4 O/H LOC. 5 O/H LOC. 29 O/H LOC. 30	19'-6"	11'-0"	L3	C-7 C-8	SPECIAL	4	2145	FIGURE 4
19		25,37,73	O/H LOC. 6 O/H LOC. 10 O/H LOC. 26	14'-0"	8'-0"	L3	C-7	SPECIAL	3	112	FIGURE 7
27		43,80	O/H LOC. 12 O/H LOC. 29	15'-0"	2'-0"	L3	C-7	SPECIAL	2	30	FIGURE 35
39		74	O/H LOC. 26	18'-0"	14'-6"	L3	C-7	SPECIAL	1	261	FIGURE 23

Figure 4-10: QUANTITY (Highlighted)

4.3.9 Sign Area

The sign area column, as shown in Figure 4-11, is the square feet of the sign panel for each sign text number.

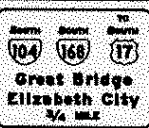





TEXT NO.	TEXT	SIGN NO.	SIGN STRUCT. STD.	PANEL SIZE IN FT - IN		LETTER TYPE	COLOR COMB.	STD. NO.	QUANTITY	SIGN AREA SQ. FT. EA	REMARKS
				W	H						
8		41,55,58,68,105	MBM	3'-0"	4'-0"	L1	C-15 C-1	SPECIAL	5	12	41 - MEDIAN BARRIER MOUNTED 55 - MEDIAN BARRIER MOUNTED 58 - MEDIAN BARRIER MOUNTED 68 - MEDIAN BARRIER MOUNTED 105 - MEDIAN BARRIER MOUNTED FIGURE 41
16		13,18,79,82	O/H LOC.4 O/H LOC.5 O/H LOC.29 O/H LOC.30	19'-6"	11'-0"	L3	C-7 C-8	SPECIAL	4	2145	FIGURE 4
19		25,37,73	O/H LOC.6 O/H LOC.10 O/H LOC.26	14'-0"	8'-0"	L3	C-7	SPECIAL	3	112	FIGURE 7
27		43,80	O/H LOC.12 O/H LOC.29	15'-0"	2'-0"	L3	C-7	SPECIAL	2	30	FIGURE 35
39		74	O/H LOC.26	18'-0"	14'-6"	L3	C-7	SPECIAL	1	261	FIGURE 23

Figure 4-11: SIGN AREA (Highlighted)

4.3.10 Remarks

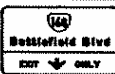
The remarks column, as shown in Figure 4-12, denotes figure references, special directions or intentions that further describe the construction requirement of the signs.

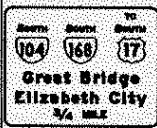





TEXT NO.	TEXT	SIGN NO.	SIGN STRUCT. STD.	PANEL SIZE IN FT - IN		LETTER TYPE	COLOR COMB.	STD. NO.	QUANTITY	SIGN AREA SQ. FT. EA	REMARKS
				W	H						
8		41,55,58,68,105	MBM	3'-0"	4'-0"	L1	C-15 C-1	SPECIAL	5	12	41 - MEDIAN BARRIER MOUNTED 55 - MEDIAN BARRIER MOUNTED 58 - MEDIAN BARRIER MOUNTED 68 - MEDIAN BARRIER MOUNTED 105 - MEDIAN BARRIER MOUNTED FIGURE 41
16		13,18,79,82	O/H LOC.4 O/H LOC.5 O/H LOC.29 O/H LOC.30	19'-6"	11'-0"	L3	C-7 C-8	SPECIAL	4	2145	FIGURE 4
19		25,37,73	O/H LOC.6 O/H LOC.10 O/H LOC.26	14'-0"	8'-0"	L3	C-7	SPECIAL	3	112	FIGURE 7
27		43,80	O/H LOC.12 O/H LOC.29	15'-0"	2'-0"	L3	C-7	SPECIAL	2	30	FIGURE 35
39		74	O/H LOC.26	18'-0"	14'-6"	L3	C-7	SPECIAL	1	261	FIGURE 23

Figure 4-12: REMARKS (Highlighted)

4.4 WOOD POST STRUCTURE CALCULATIONS

Calculations for determining the length of wood post structures are as shown and in [Appendix IIB-7](#) for Single Wood Posts and [Appendix IIB-8](#) for Double Wood Posts.

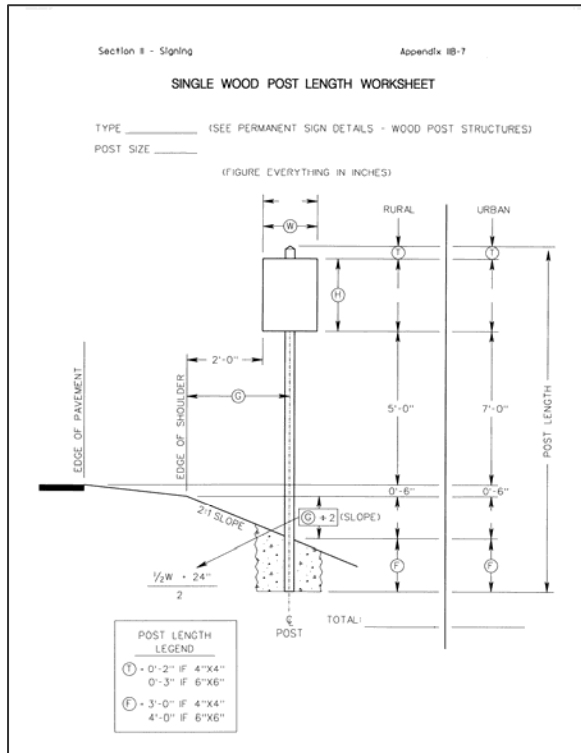

SINGLE WOOD POST CALCULATION WORKSHEET
 (See Appendix IIB-7)

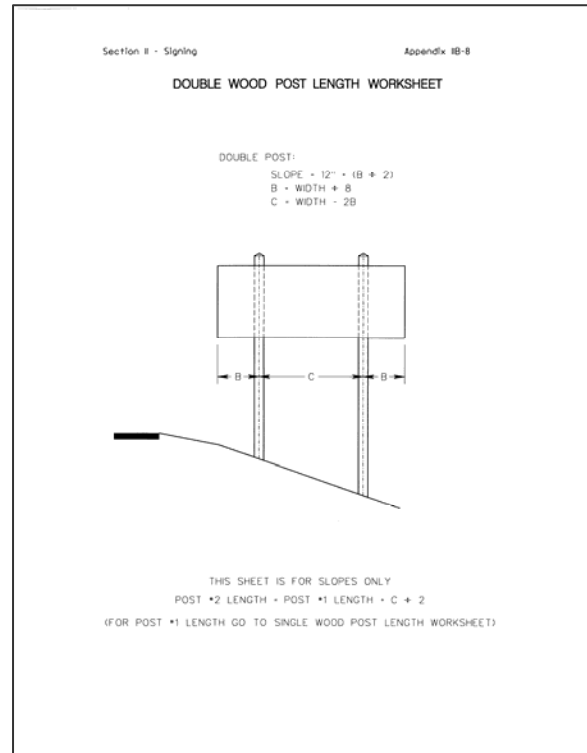

DOUBLE WOOD POST CALCULATION WORKSHEET
 (See Appendix IIB-8)

Details for determining type of wood post are provided in the [VDOT Road and Bridge Standards, Volume II, Section 1300](#), Pages 1301.55 and 1301.56. Post installation and mounting height guidelines are provided on Page 1301.58. The procedure for calculating the size of the wood post is provided on Pages 1301.95 to 1301.106. Mounting height and slope at the sign location are required to determine which chart to use for these computations. The design standards are located under WSP-1 and calculation procedures are located under SPSC-1, SCI-1 and PSI-1.

4.5 TYPE VA SIGN STRUCTURE DETAIL

Instructions to determine the type and details for Type VA Sign Structures are provided in the [VDOT Road and Bridge Standards, Volume II, Section 1300](#), Pages 1301.59 to 1301.66. Additionally, support and foundation detail standards are provided under SSP-VA.

- The type and details for Non-Standard Type VA Sign Structures can be determined using the Sign Structure Type VA Data Calculation, as shown and in [Appendix IIB-9](#).

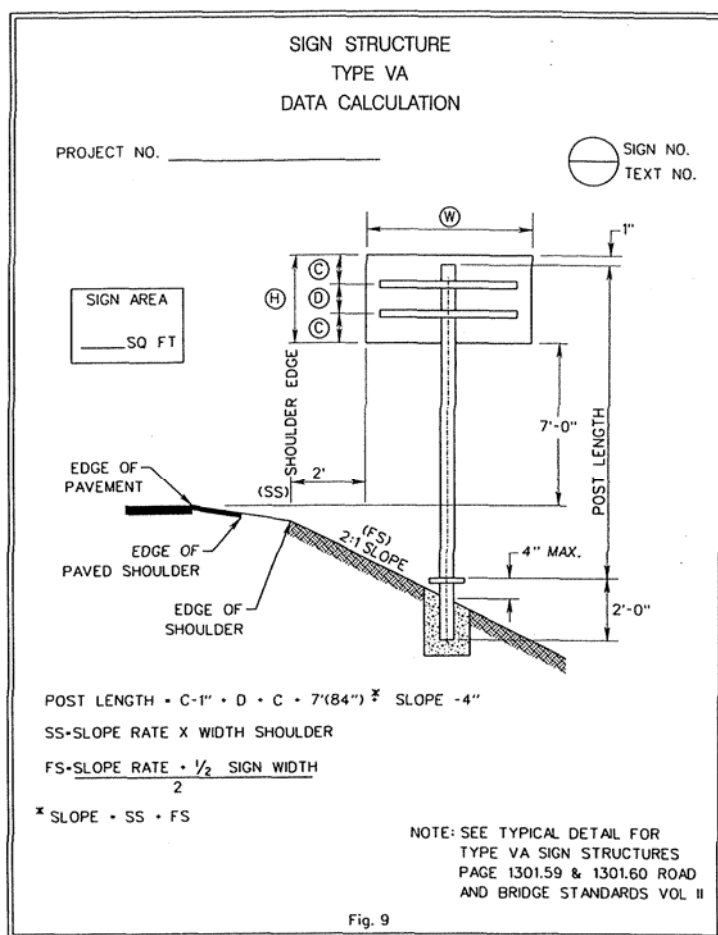

SIGN STRUCTURE CALCULATIONS – TYPE VA
(See Appendix IIB-9)

- In some instances sign size discrepancies will occur. In those instances, the information for support details in the [VDOT Road and Bridge Standards, Volume II, Section 1300](#), Pages 1301.60 will have to be modified based on the sign dimensions: W, H, c, d, post length and TEE Bar number and length. This

information will be placed on the Chart for Non-Standard VA Structures, as shown and in [Appendix IIA-11](#). The designer should reference [Appendix IIB-6](#) where typical dimensions for c & d are provided.

- When using the SignFix software for alternate sign panel attachment details that are on ground mounted signs, the input for sign panel thickness shall be 0.100-inch, the channel size shall be medium and the wind loading shall be 80 mph.

4.6 TYPE VIA SIGN STRUCTURE DETAIL

Preparing the Type VIA Sign Structure Detail Sheet, as shown and in [Appendix IIA-11](#), provides sign panel, attachment, and support detail data. This sheet is developed using references charts and calculation work sheets, which are available in [Appendices IIB-10, IIB-11, IIB-12 and IIB-45](#).

Section II - Signing

TYPE VIA SIGN STRUCTURE DETAILS

SIGN STRUCTURE TYPE	SIGN PANEL THICKNESS	TYPICAL SIGN PANEL ATTACHMENT DETAILS				ALTERNATE SIGN PANEL ATTACHMENT DETAILS				SUPPORT																											
		W	H	C	D	NO. 1	NO. 2	NO. 3	NO. 4	POST LENGTH	ANCHOR BOLT	BASE CONNECTION DATA TABLE			PILE AND ANGLE PLATE DATA TABLE			PILE BEARING PLATE DATA TABLE																			
1	0.100	4'-0"	8'-0"	1'-0"	1'-0"	1	2	3	4	10'-0"	1/2"	A	B	C	D	E	F	G	H	I	J	K	L	M	N	O	P	Q	R	S	T	U	V	W	X	Y	Z

NOTE TO DESIGNER:
REFER TO INSTRUCTIONS AND SUPPLEMENTAL CHARTS FOR CALCULATING DATA WHEN PANEL SIZE IS NOT GIVEN ON WORKSHEET FOR FOUNDATION DETAILS. REFER TO PAGE 130170 OF THE ROAD AND BRIDGE STANDARDS.

TYPICAL DETAILS FOR NON-STANDARD TYPE VA SIGN STRUCTURES

SIGN STRUCTURE TYPE	SIGN PANEL THICKNESS	TYPICAL SIGN PANEL ATTACHMENT DETAILS		ALTERNATE SIGN PANEL ATTACHMENT DETAILS		POST DIMENSIONS		FOUNDATION DIMENSIONS		WELDED WIRE MESH		STEEL BASE PLATE	
		W	H	W	H	POST SIZE	POST SLOPE	CLAMP	DA	LENGTH	SOFT	THICKNESS	TYPE
1	0.100	4'-0"	8'-0"	4'-0"	8'-0"	4"	0-0"	12"	4"	12"	12"	1/2"	12"

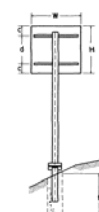
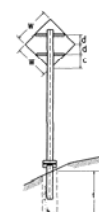
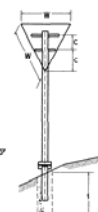
NOTES FOR TYPE VA AND VIA SIGN STRUCTURES:

1. For maximum height, refer to Appendix IIB-45 and minimum projection of foundation slab, refer Virginia Department of Transportation, Standard Specifications for Road and Bridge Construction.

2. Post height when on slope is based for 2% slope. Make slope smaller field checked by the contractor prior.

TYPE VIA SIGN STRUCTURE DETAIL SHEET (See Appendix IIA-11)

- The Sign Structure Detail Chart, as shown and in [Appendix IIB-45](#), provides VIA sign structure types, typical and alternate sign panel attachments, as well as, support values. The data represented on the Sign Structure Detail Chart is to be used to populate the detail blocks for the Type VIA Sign Structure Detail Sheet in [Appendix IIA-11](#).
- The VIA sign structure type is determined by matching the height and width of the specific sign panel under consideration to those outlined in the Sign Structure Detail Chart.
- Most sign panel sizes on the project will not have dimensions exactly as shown on

the Sign Structure Detail Chart. When the sign panel dimensions vary from the Sign Structure Detail Chart, the following subsections will provide design strategies to be used to modify the sign structure type and determine the data values for the attachment details and supports:

SIGN STRUCTURE DETAIL CHART
(See Appendix IIB-45)

SIGN STRUCTURE TYPE	SIGN PANEL DIMENSIONS		TYPICAL SIGN PANEL ATTACHMENT DETAILS							ALTERNATE SIGN PANEL ATTACHMENT DETAILS						
			a	b	c	d	ZEE		TEE		a	b	c	d	STIFFENER	
							NO.	SIZE	NO.	NO.					NO.	SIZE
A	W	H	a	b	c	d	NO.	SIZE	NO.	NO.	a	b	c	d	NO.	SIZE
B	12'	4'	2'-0"	8'-0"	14"	20"	2	B	0	0	2'-0"	8'-0"	1 1/2"	2'-1"	2	LARGE
C	11'	5'	1'-6"	8'-0"	16"	28"	2	B	0	0	1'-6"	8'-0"	1 1/2"	1'-7"	4	LARGE

PARTIAL TITLE BLOCK (Enlarged View)
(See Appendix IIB-45)

4.6.1 Width Discrepancy

Locate the width of sign panel under consideration within smallest possible range of widths in the Sign Structure Detail Chart.

- If the sign panel width is less than midway between the two widths on the chart, select the lower value within the range and use all data values except the “a” and “b” dimensions of the attachment detail.

- If the sign panel width is midway or more between the two widths on the chart, select the greater value within the range and use all data values except the “a” and “b” dimensions of the attachment detail.
- The attachment detail dimensions for “a” and “b” are determined using the Supplement Sign Panel Post Spacing Chart for Multi-Post VIA Structures, as shown and in [Appendix IIB - 6](#). Use the actual sign panel width to determine “a” and “b” dimensions and interpolate, if necessary.

4.6.2 Height Discrepancy

Locate the height of the sign panel under consideration within the smallest possible range of heights in the Sign Structure Detail Chart.

- If the sign panel height is more than 6-inches greater than the smaller height dimension within the chart range, select the larger height value within the chart range and use all data except the “c” and “d” of the attachment detail and the number of Zee / Tee Bars.

Use the Supplement Zee / Tee bar Spacing Chart, as shown and in [Appendix IIB-6](#), as well as the Sign Structure Detail Chart to determine the “c” and “d” dimensions and number of the bars.

Calculate the post lengths by subtracting the height of the actual sign panel from the sign panel height obtained from the Sign Structure Detail Chart and then subtract the difference from the post length values from the Sign Structure Detail Chart to get the actual post length.

- If the sign height is 6-inches or less than the smaller height dimension within the chart range, use the smaller height dimension within the chart range to determine all data except the “c” and “d” post lengths and number of bars.

Use the Supplement Zee / Tee bar Spacing Chart, as shown and in [Appendix IIB-6](#) and the Sign Structure Detail Chart to determine the “c” and “d” dimensions and number of the bars.

Calculate the post lengths by subtracting the height of the actual sign panel from the sign panel height obtained from the Sign Structure Detail Chart and then add the difference back to the post length values from the Sign Structure Detail Chart to get the actual post length.

4.6.3 Width and Height Discrepancies

If variances occur in both width and height dimensions, it will be necessary to complete both design strategies as described in 4.6.1 and 4.6.2. Use the results to determine the subsequent structure type and its associated support data.

Section II - Signing Appendix IIB-6

**SUPPLEMENT
ZEE/TEE BAR SPACING**
(FOR SIGN HEIGHTS NOT SHOWN ON THE VIA WORKSHEET)

SIGN HEIGHT	"C"		SIGN HEIGHT	"D"	
	"C"	"D"		"C"	"D"
3'-0"	9"	1'-6"	11'-0"	18"	4'-0"
3'-6"	12"	1'-6"	11'-0"	12"	3'-0"
4'-6"	14"	2'-2"	11'-6"	18"	4'-3"
5'-0"	16"	2'-4"	11'-6"	15"	3'-0"
5'-6"	15"	3'-0"	12'-6"	12"	3'-6"
6'-6"	15"	4'-0"	13'-0"	18"	3'-4"
7'-0"	12"	2'-6"	13'-6"	18"	3'-6"
7'-6"	12"	2'-9"	14'-6"	18"	3'-10"
8'-6"	15"	3'-0"	15'-0"	18"	3'-0"
9'-6"	18"	3'-3"	15'-6"	15"	3'-3"
10'-6"	18"	3'-9"	16'-6"	18"	3'-4½"

¹ 3 BARS: SIGN WIDTHS 19' THRU 30'-6"
² 4 BARS: SIGN WIDTHS 12' THRU 18'-6"
³ 4 BARS: ALWAYS

**SUPPLEMENT
SIGN PANEL POST SPACING CHART FOR
MULTI-POST VIA STRUCTURES**
(TYPICAL ONLY)

PANEL WIDTH	POST SPACING		PANEL WIDTH	POST SPACING	
	"A"	"B"		"A"	"B"
9'-6"	9"	8'-0"	18'-0"	4'-0"	10'-0"
10'-0"	1'-0"	8'-0"	18'-6"	4'-3"	10'-0"
10'-6"	1'-3"	8'-0"	19'-0"	4'-4"	10'-4"
11'-0"	1'-6"	8'-0"	19'-6"	4'-6"	10'-6"
11'-6"	1'-9"	8'-0"	20'-0"	4'-6"	11'-0"
12'-0"	2'-0"	8'-0"	20'-6"	4'-9"	11'-0"
12'-6"	2'-3"	8'-0"	21'-0"	4'-10"	11'-4"
13'-0"	2'-6"	8'-0"	21'-6"	4'-11"	11'-8"
13'-6"	2'-9"	8'-0"	22'-0"	4'-10"	12'-4"
14'-0"	3'-0"	8'-0"	22'-6"	5'-2"	12'-2"
14'-6"	3'-3"	8'-0"	23'-0"	5'-3"	12'-6"
15'-0"	3'-5"	8'-2"	23'-6"	5'-5"	12'-8"
15'-6"	3'-7"	8'-4"	24'-0"	5'-4"	13'-4"
16'-0"	3'-6"	9'-0"	24'-6"	5'-8"	13'-2"
16'-6"	3'-9"	9'-0"	25'-0"	5'-9"	13'-6"
17'-0"	3'-11"	9'-2"	25'-6"	5'-10"	13'-10"
17'-6"	4'-0"	9'-6"

**SUPPLEMENT FOR:
ZEE / TEE BAR SPACING
AND
SIGN PANEL POST SPACING CHART
FOR 2 POST VIA STRUCTURES
(See Appendix IIB-6)**

4.6.4 Alternate Attachment Method

The designer should utilize the same support data used in the typical attachment method along with adjusted values for sign panel dimension discrepancies generated through the SignFix Software.

Regardless of the attachment method used, a minimum distance between sign posts shall be 8 feet for all VIA Sign Structures.

After determining the type of structure to be used, the designer should refer to [VDOT Road and Bridge Standards, Volume II, Section 1300](#), Page 1301.70 for the Type VIA foundation details. Additionally, foundation detail standards are provided under SSP-VIA.

4.7 OVERHEAD (O/H) SIGN STRUCTURE ELEVATION DETAIL SHEET

Preparing the Overhead Sign Structure Elevation Detail Sheet, as shown and in Appendix IIA-8, provides information and data reflecting the relationship of the O/H signs and structures in relation to the roadway cross section, such as lane widths, shoulders, guardrails, sound walls, etc. It also provides sign support data for the sign panels.

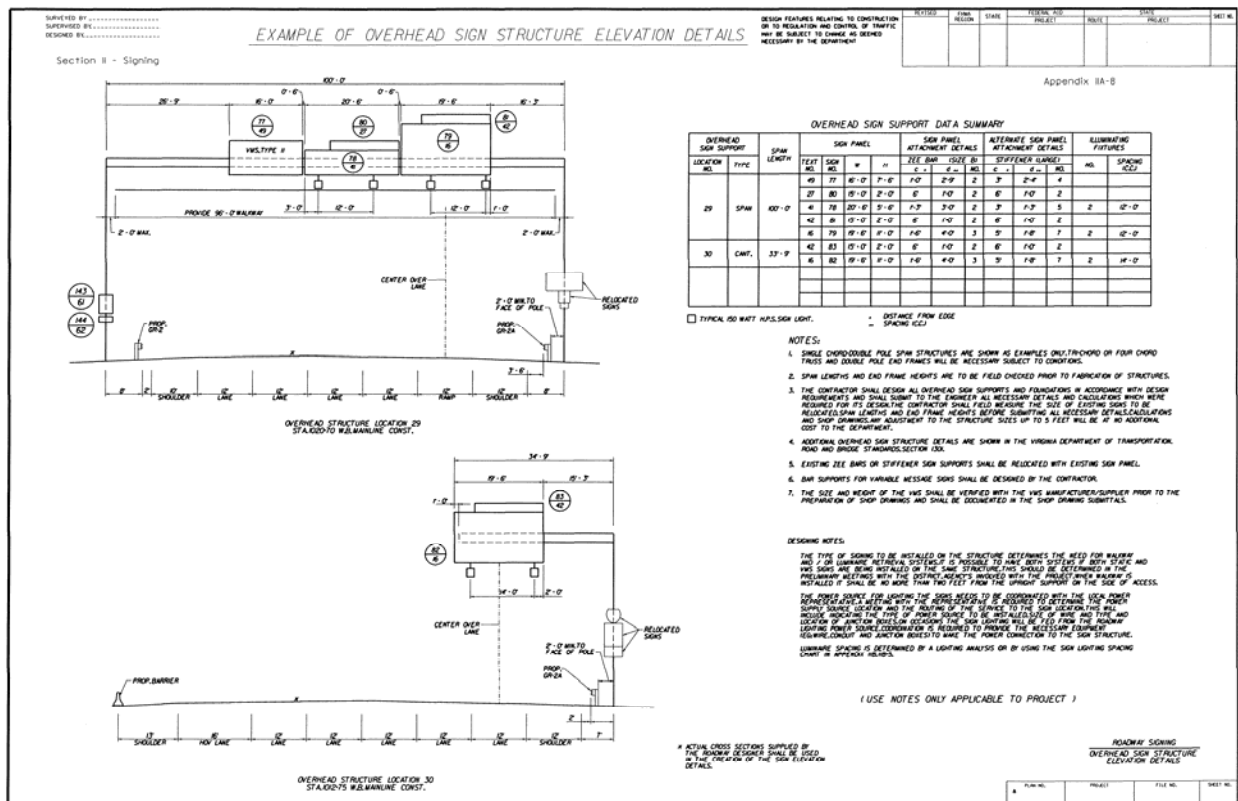

OVERHEAD SIGN STRUCTURE ELEVATION DETAIL SHEET
(See Appendix IIA-8)

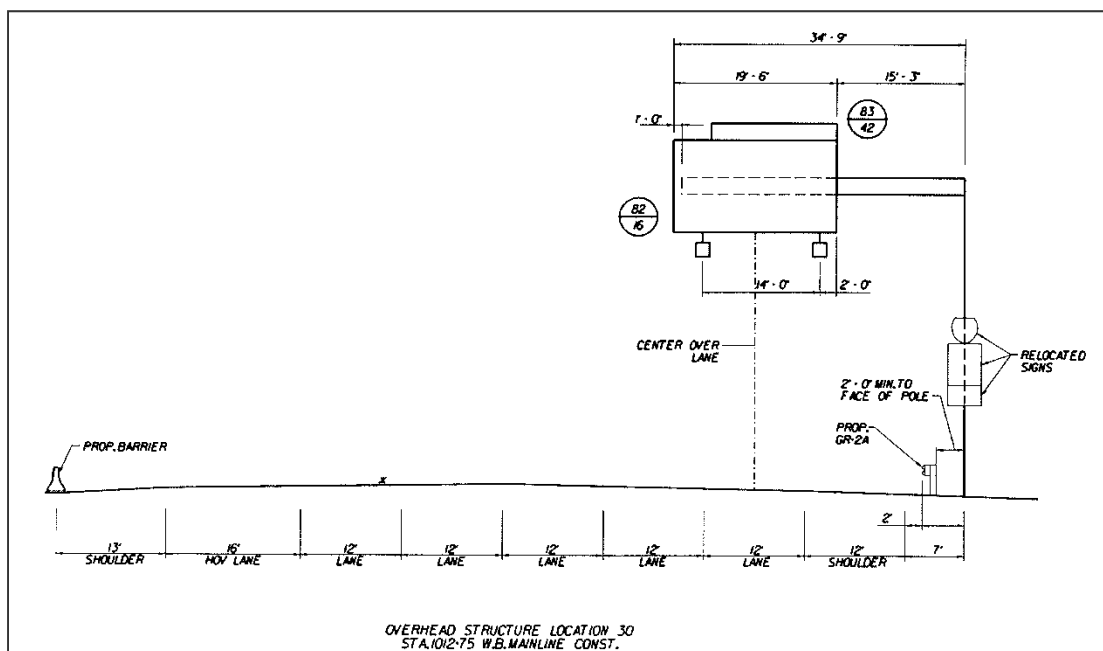

**OVERHEAD SIGN STRUCTURE ELEVATION DETAIL SHEET (Partial Enlarged View)
(See Appendix IIA-8)**

Developing the Overhead Sign Structure Elevation Detail Sheet requires evaluating the sign location and populating the Overhead Sign Support Data Summary Chart. The following instructions will assist in filling out the chart:

- **Illustrate the Sign Structure Dimensions**
Obtain an accurate and current roadway design typical and cross-section of the location to establish placement and location of the sign structure relative to the roadway features.
- **Determine the Sign Panel Data**
Populate the sign panel data in the Overhead Sign Support Data Summary using the Sign Schedule Sheet, (e.g. Text No., Sign No. and the panel size dimensions).
- **Determine the Sign Panel Attachment Details**
Populate the sign panel attachment detail data in the Overhead Sign Support Data Summary using the instructions previously discussed in Subsection 4.6 or if height discrepancies are encountered use the height discrepancy strategy discussed in Subsection 4.6.2 with the exception that all bars shall be Zee Type, Size “B”.
- **Determine the Alternate Sign Panel Attachment Details**
SignFix software is used for alternate sign panel attachment details, the input for sign panel thickness shall be 0.100-inch, the channel size shall be large and the wind loading shall be 100 mph.

- Determine the Illuminating Fixtures

The Illuminating Fixtures information is obtained from the Illuminating Engineering Society of North America, Recommended Practice for Roadway Sign Lighting, (IESNA RP-19). If IESNA RP-19 is not available, the chart for Sign Lighting Spacing, as shown and in [Appendix IIB-5](#), can be used to provide the lighting information. If “LUMI-TRAK” system is being considered, refer to memo in [Appendix IIB-47](#).

Additional information discussing Sign Lighting can be found in the [TEDM, Section V – Roadway Lighting, Chapter 4, 4.5.1](#).

Section II – Signing Appendix IIB-5

SIGN LIGHTING SPACING

Sign Width	Spacing			No. of Lights
8'-0"	4'-0"	*	4'-0"	1
8'-6"	4'-3"	*	4'-3"	1
9'-0"	4'-6"	*	4'-6"	1
9'-6"	4'-9"	*	4'-9"	1
10'-0"	5'-0"	*	5'-0"	1

Sign Width	Spacing			No. of Lights
10'-6"	3'-0"	*	4'-6"	2
11'-0"	3'-0"	*	5'-0"	2
11'-6"	3'-0"	*	5'-6"	2
12'-0"	3'-0"	*	6'-0"	2
12'-6"	3'-3"	*	6'-0"	2
13'-0"	3'-6"	*	6'-0"	2
13'-6"	3'-6"	*	6'-6"	2
14'-0"	3'-6"	*	7'-0"	2
14'-6"	3'-6"	*	7'-6"	2
15'-0"	3'-6"	*	8'-0"	2
15'-6"	3'-9"	*	8'-0"	2
16'-0"	4'-0"	*	8'-0"	2
16'-6"	4'-3"	*	8'-0"	2
17'-0"	4'-3"	*	8'-6"	2
17'-6"	4'-3"	*	9'-0"	2
18'-0"	4'-6"	*	9'-0"	2
18'-6"	4'-9"	*	9'-0"	2
19'-0"	4'-9"	*	9'-6"	2
19'-6"	4'-9"	*	10'-0"	2
20'-0"	5'-0"	*	10'-0"	2

Sign Width	Spacing						No. of Lights
20'-6"	3'-9"	*	6'-6"	*	6'-6"	*	3
21'-0"	3'-6"	*	7'-0"	*	7'-0"	*	3
21'-6"	3'-9"	*	7'-0"	*	7'-0"	*	3
22'-0"	4'-0"	*	7'-0"	*	7'-0"	*	3
22'-6"	3'-9"	*	7'-6"	*	7'-6"	*	3
23'-0"	4'-0"	*	7'-6"	*	7'-6"	*	3
23'-6"	3'-9"	*	8'-0"	*	8'-0"	*	3
24'-0"	4'-0"	*	8'-0"	*	8'-0"	*	3
24'-6"	4'-3"	*	8'-0"	*	8'-0"	*	3
25'-0"	4'-6"	*	8'-0"	*	8'-0"	*	3
25'-6"	4'-3"	*	8'-6"	*	8'-6"	*	3
26'-0"	4'-6"	*	8'-6"	*	8'-6"	*	3
26'-6"	4'-3"	*	9'-0"	*	9'-0"	*	3
27'-0"	4'-6"	*	9'-0"	*	9'-0"	*	3
27'-6"	4'-9"	*	9'-0"	*	9'-0"	*	3
28'-0"	5'-0"	*	9'-0"	*	9'-0"	*	3
28'-6"	4'-9"	*	9'-6"	*	9'-6"	*	3
29'-0"	4'-6"	*	10'-0"	*	10'-0"	*	3
29'-6"	4'-9"	*	10'-0"	*	10'-0"	*	3
30'-0"	5'-0"	*	10'-0"	*	10'-0"	*	3

* denotes symbol for sign light. The above charts are to be used for 150W high pressure sodium.

SIGN LIGHTING SPACING CHART (See Appendix IIB-5)

- In addition, the following design issues must be evaluated:
 - Clear zone requirements, which is available in the [VDOT Road Design Manual, Section A-2 – Clear Zone Guidelines](#).
 - Guardrail deflection requirements, which is available in the [VDOT Road and Bridge Standards, Volume I Section 500](#).
 - Conflicts with sound walls and utilities (overhead and underground).
 - Combined concrete barrier / sign structure foundation design.
 - Airport and heliport flight path clear zones as discussed in [TEDM, Section I – General, Chapter 4, 4.5](#).
- Additional Overhead Sign Structure Considerations
 - Cantilever arm lengths should not exceed 50-feet in length and the edge of the sign panel should extend 1-foot beyond the end of the arm.
 - When lighting is required on overhead signing it will be necessary to meet with a local power representative to determine the power source routing and identify power pole numbers from which the power would be supplied for service. On some projects this will be coordinated with the roadway lighting. Others will require obtaining separate power sources and providing the wire routing along with wire sizing and junction box locations. Additional information discussing locating and furnishing the power source locations can be found in the [TEDM, Section V – Roadway Lighting, Chapter 3, 3.7](#).

4.8 NOTES FOR SAFETY IMPROVEMENT ITEMS SHEET

Preparing the Notes for Safety Improvement Items Sheet provides information regarding the construction activities for existing signs within the project limits. The General Notes, Measurement and Payment Items, and Definition of Types for the existing sign plans are as shown and in [Appendix IIA-9](#).

NOTE TO DESIGNER: SEVERAL EXAMPLES OF THE USE OF THIS SHEET ARE SHOWN ON APPENDIX IIA-3

GENERAL NOTES

1. Verify all dimensions, quantities, and materials are correct before beginning construction. Verify all dimensions are correct before beginning construction.
2. Verify all dimensions, quantities, and materials are correct before beginning construction. Verify all dimensions are correct before beginning construction.
3. Verify all dimensions, quantities, and materials are correct before beginning construction. Verify all dimensions are correct before beginning construction.
4. Verify all dimensions, quantities, and materials are correct before beginning construction. Verify all dimensions are correct before beginning construction.
5. Verify all dimensions, quantities, and materials are correct before beginning construction. Verify all dimensions are correct before beginning construction.
6. Verify all dimensions, quantities, and materials are correct before beginning construction. Verify all dimensions are correct before beginning construction.
7. Verify all dimensions, quantities, and materials are correct before beginning construction. Verify all dimensions are correct before beginning construction.
8. Verify all dimensions, quantities, and materials are correct before beginning construction. Verify all dimensions are correct before beginning construction.
9. Verify all dimensions, quantities, and materials are correct before beginning construction. Verify all dimensions are correct before beginning construction.
10. Verify all dimensions, quantities, and materials are correct before beginning construction. Verify all dimensions are correct before beginning construction.

MEASUREMENT & PAYMENT ITEMS

1. MEASURE AND PAYMENT FOR THE CONSTRUCTION OF THE SIGN PANELS...
2. MEASURE AND PAYMENT FOR THE CONSTRUCTION OF THE SIGN STRUCTURE...
3. MEASURE AND PAYMENT FOR THE CONSTRUCTION OF THE SIGN FOUNDATION...
4. MEASURE AND PAYMENT FOR THE CONSTRUCTION OF THE SIGN LIGHTING...
5. MEASURE AND PAYMENT FOR THE CONSTRUCTION OF THE SIGN MATERIALS...
6. MEASURE AND PAYMENT FOR THE CONSTRUCTION OF THE SIGN ACCESSORIES...
7. MEASURE AND PAYMENT FOR THE CONSTRUCTION OF THE SIGN FINISHES...
8. MEASURE AND PAYMENT FOR THE CONSTRUCTION OF THE SIGN INSTALLATION...
9. MEASURE AND PAYMENT FOR THE CONSTRUCTION OF THE SIGN REMOVAL...
10. MEASURE AND PAYMENT FOR THE CONSTRUCTION OF THE SIGN REPAIRS...

DEFINITION OF TYPES

TYPE	DESCRIPTION	UNIT
01	Sign Panel	SQ
02	Sign Structure	EA
03	Sign Foundation	EA
04	Sign Lighting	EA
05	Sign Materials	SQ
06	Sign Accessories	EA
07	Sign Finishes	SQ
08	Sign Installation	EA
09	Sign Removal	EA
10	Sign Repairs	EA

NOTES FOR SAFETY IMPROVEMENT ITEMS

MEASUREMENT & PAYMENT ITEMS

DEFINITION OF TYPES

NOTES FOR SAFETY IMPROVEMENT ITEMS (See Appendix IIA-9)

- General Notes

Provides general information related to the sign plans and applies throughout the project plan set. An important component of the General Notes is the definition of symbols, as shown and in [Appendix IIA-9](#). The ellipse symbol is used on the plan sheet to provide instruction on the action to be taken for an existing sign and / or sign structure.

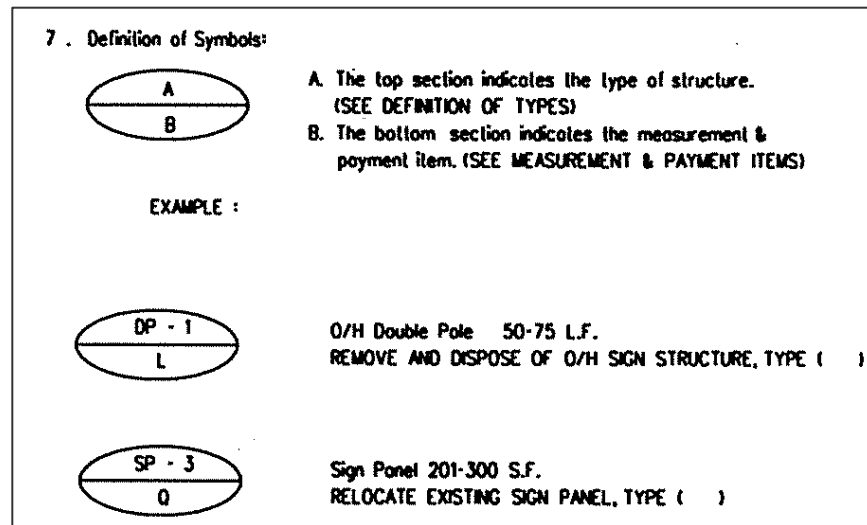

**NOTES FOR SAFETY IMPROVEMENT ITEMS
(Enlarged View)
(See Appendix IIA-9)**

- Measurement and Payment Items

Provides a Measurement and Payment code for the existing signs and/or sign structures. Each Measurement and Payment Item is coded with a letter that describes the action to be taken and the method of payment. The code for the Measurement and Payment Item is placed in the lower half of the ellipse symbol. In some cases it may be necessary to modify the Measurement & Payment Items list to accommodate the needs of the project.

- Definition of Types

Provides a Definition of Types code for the existing signs and/or sign structures. The code describes the type and size of the existing sign and/or sign structure and is placed in the upper half of the ellipse symbol.

- The description for the Measurement and Payment Item with the Definition of Types code placed where the parenthesis are located, provides the Pay Item that will be used in the Summary of Quantity Sheet, (e.g. RELOCATE EXISTING SIGN STRUCTURE, TYPE DP-1).

4.9 EXIT NUMBER SIGN PANELS DETAILS

4.9.1 Typical details for exit number sign panels

The Typical Details for Exit Number Sign Panel sheet is used to identify the horizontal Zee Bar & vertical Zee Bar size and length for all exit panels mounted above a guide sign. The sizes for both horizontal Zee Bars & vertical Zee Bars are always the same for both columns (Whatever one size is, the other will be the same). Typical details for mounting exit number sign panels are shown and in [Appendix IIA-10](#).

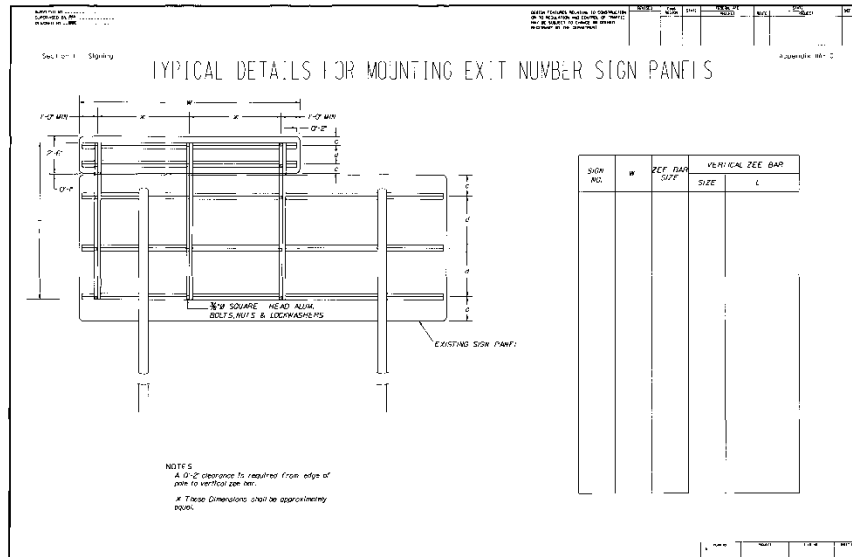

TYPICAL DETAILS FOR MOUNTING EXIT NUMBER SIGN PANELS
 (See Appendix IIA-10)

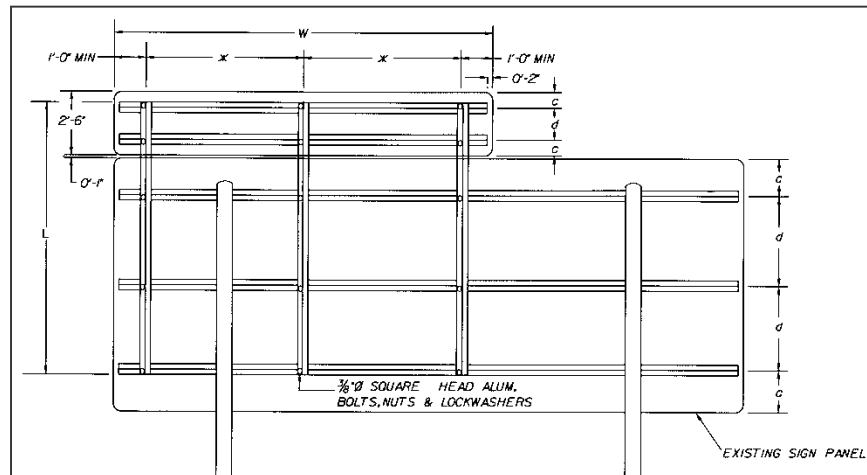

TYPICAL DETAILS FOR MOUNTING EXIT NUMBER SIGN PANELS
 (Partial Enlarged View)
 (See Appendix IIA-10)

- The size of the Zee Bar is based on the guide sign it is mounted above and will always be “B” for both columns if they are mounted on O/H sign structures.
- The size for the Zee Bar may vary if dealing with a ground mounted sign structure. Determine the size using the actual size of the sign and refer to Sign Structure Detail Chart, as shown in [Appendix IIB-45](#).
- The Vertical Zee Bar L (length) is determined by finding and adding the “c” dimension for both signs using the Sign Structure Details. Subtract it from the total height of both signs added together, then add 1-inch.

4.9.2 Exit Number Sign Panel Sizes

The Exit Number Sign Panel Sizes sheet, as shown and in [Appendix IIB-15](#), can be used to determine the letter and panel size details.

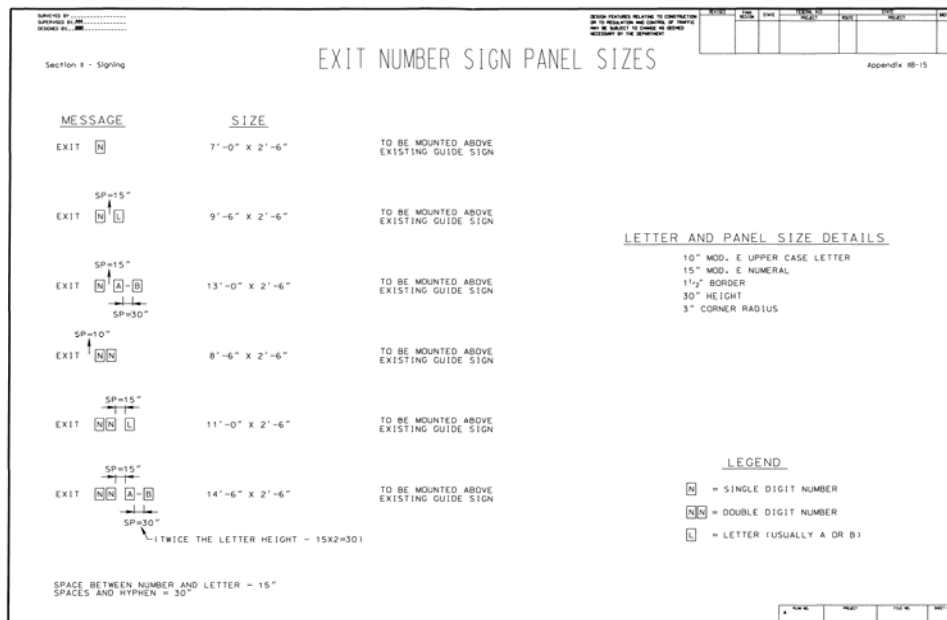

EXIT NUMBER SIGN PANEL SIZES
(See Appendix IIB-15)

4.9.3 Interstate Arrows

The Interstate Arrows sheet, as shown and in [Appendix IIB-16](#) can be used to determine detail information for Interstate arrows.

Section II - Signing

EXIT GORE SIGN SIZES

MESSAGE	SIZE	MOUNTING
EXIT [N] [A]	6'-0" X 5'-0"	MAY BE MOUNTED ON EXISTING W4X13
EXIT [N] [E]	6'-0" X 5'-0"	MAY BE MOUNTED ON EXISTING W4X13
EXIT [N] [N]	6'-0" X 5'-0"	MAY BE MOUNTED ON EXISTING W4X13
EXIT [N] [N] [A]	7'-6" X 5'-0"	MAY BE MOUNTED ON EXISTING W6X12

NO SPACE

LETTER AND PANEL SIZE DETAILS

12" MOD. E UPPER CASE LETTER
 18" MOD. E NUMERAL
 18" MOD. E LETTER
 1 1/2" BORDER
 6" CORNER RADIUS FOR SINGLE DIGIT
 8" CORNER RADIUS FOR DOUBLE DIGIT

LEGEND

[N] = SINGLE DIGIT NUMBER
 [N] [N] = DOUBLE DIGIT NUMBER
 [A] = LETTER (USUALLY A OR B)

45° ARROW SIZE

23" - HORIZONTAL AND VERTICAL
 29 1/2" - LENGTH

Appendix IIB-16

INTERSTATE ARROWS

ANGLE	LETTER SIZE	A	B	C
30°	10"-13.3" U.C.	18 1/2"	27"	29 1/4"
	15"-16" U.C.	22 5/8"	32 3/4"	35 5/8"
45°	10"-13.3" U.C.	23"	23"	29 1/4"
	15"-16" U.C.	28"	28"	35 5/8"
60°	10"-13.3" U.C.	27"	19"	29 1/4"
	15"-16" U.C.	32 3/4"	22 3/4"	35 5/8"

* Interstate arrows for use with 6" and 8" U.C. letters shall be in accordance with the Virginia supplement to the MUTCD.

**EXIT GORE SIGN SIZES / INTERSTATE ARROWS SHEET
(See Appendix IIB-16)**

4.10 SUMMARY OF QUANTITIES SHEET

The Summary of Quantities sheet(s), as shown and in [Appendix IIA-12](#) provides the pay item quantities for the sign plan set and is used for establishing construction cost estimates and bid unit prices for the sign project.

- Quantity takeoffs for all pay items are totaled on each plan sheet and transferred to the Summary of Quantities sheet. The unit for the pay item is the measurement by which the pay item is paid for and is established in the VDOT Road and Bridge Specifications as a Standard pay item. If the pay item is a Non-Standard pay item, a Special Provision or Special Provision Copied Note may be required. Further discussion is provided in [TEDM Section I – General, Chapter 3, 3.7](#). The project quantity total for each pay item is provided at the bottom of each pay item column.
- Contracts with more than one project number or funding source should have a separate quantity summary for each project.

