

APPENDIX H

VDOT Road and Bridge Standards Excerpts

EC-1	Culvert Outlet Protection
EC-2	Protective Covering Installation Criteria
EC-3	Soil Stabilization Mat - 3 of 3
EC-4	Rock Check Dams I and II
EC-5	Temporary Silt Fence and Filter Barrier
EC-6	Drop Inlet Silt Trap
EC-7	Typical Sediment Trap
EC-8	Dewatering Basin
EC-9	Temporary Diversion Dike
L-3	Typical Method for Bench Planting On Rock Cut Section
L-3A	Typical Method For Horizontal Grooving Cut Slopes
PG-2A	Standard Paved Ditches
PG-3	Standard Riprap Ditch and Slope Protection
PG-5	Standard Paved Ditches
SWM-1	SWM Drainage Structure - 2 of 2
SWM-DR	Stormwater Management Details – 5 of 5
TD-CL	Temporary Diversion Channel
ESC-INS	Temporary Erosion and Siltation Control - 3 of 3
	Roadside Development – Drawing A-4, A-5, A-6
	Sinkhole Treatment Details

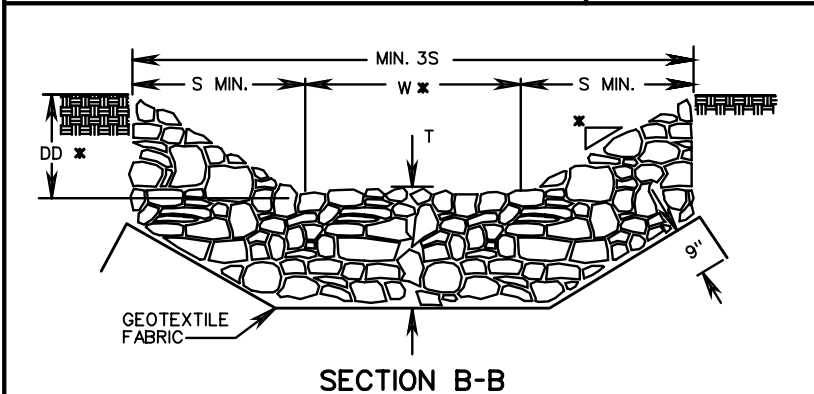
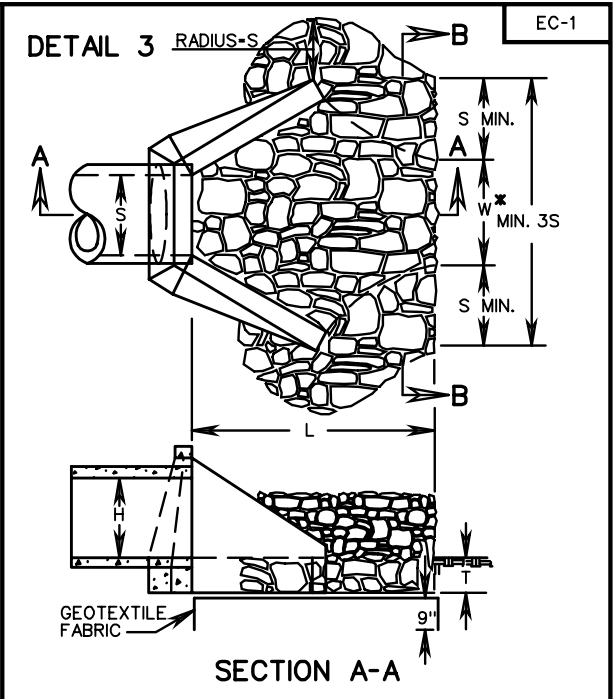
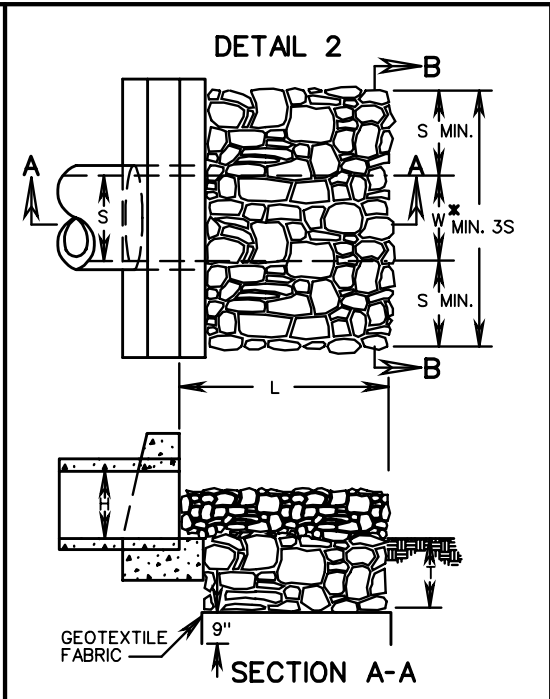
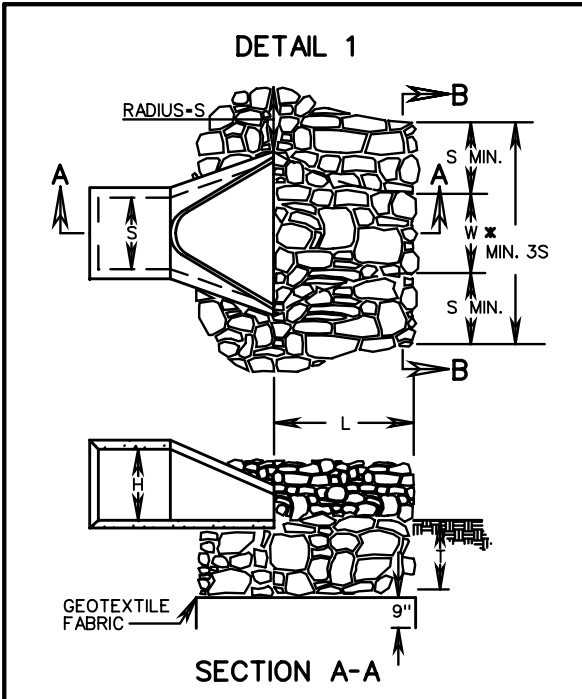

NOTES:

1. FOR MULTIPLE LINE INSTALLATIONS, DIMENSION S IS TO GOVERN THE PROTECTION OUTSIDE THE CHANNEL WIDTH (W).
2. ON ANY INSTALLATION REQUIRING CULVERT OUTLET PROTECTION WHERE NO ENDWALL OR ENDSECTION IS SPECIFIED ON THE PLANS, CONSTRUCTION IS TO BE IN ACCORDANCE WITH DETAIL 2 SHOWN ABOVE.
3. GEOTEXTILE FABRIC TO BE INSTALLED UNDER CLASS A1, I, AND II MATERIALS IN ACCORDANCE WITH THE SPECIFICATIONS.
4. S - DIAMETER OF CIRCULAR CULVERT OR SPAN FOR BOX, ELLIPTICAL OR ARCH CULVERT. H - DIAMETER OF CIRCULAR CULVERT OR RISE/HEIGHT FOR BOX, ELLIPTICAL OR ARCH CULVERT.

* USE TYPICAL SECTION SHOWN ON PLANS FOR SIDE SLOPE, BOTTOM WIDTH AND DEPTH OF CHANNEL OR MATCH EXISTING DITCH OR NATURAL GROUND.

TYPE OF OUTLET PROTECTION MATERIAL		MAXIMUM OUTLET VELOCITY (FOR DESIGN STORM)	MINIMUM "T" (INCHES)
CLASS A1	CLASS A1 DRY RIPRAP	8 fps	18
CLASS I	CLASS I DRY RIPRAP	14 fps	24
CLASS II	CLASS II DRY RIPRAP	19 fps	36

OUTLET PROTECTION MINIMUM LENGTH (L)	
TYPE A INSTALLATION	3H
TYPE B INSTALLATION	5H

SPECIFICATION REFERENCE
204
245
303
414

CULVERT OUTLET PROTECTION

VIRGINIA DEPARTMENT OF TRANSPORTATION

REV 8/07

114.01

EC-2

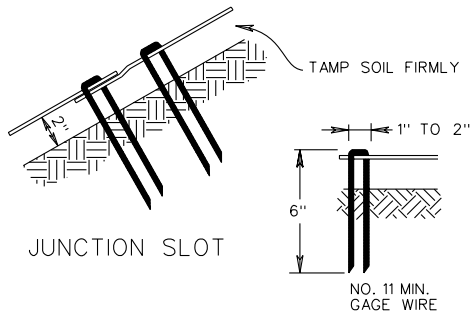
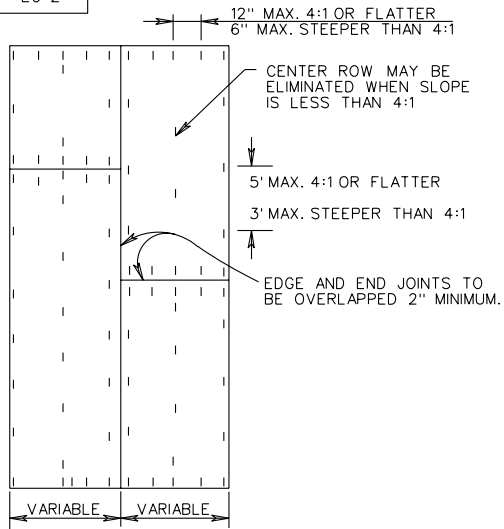

SOIL RETENTION MAT

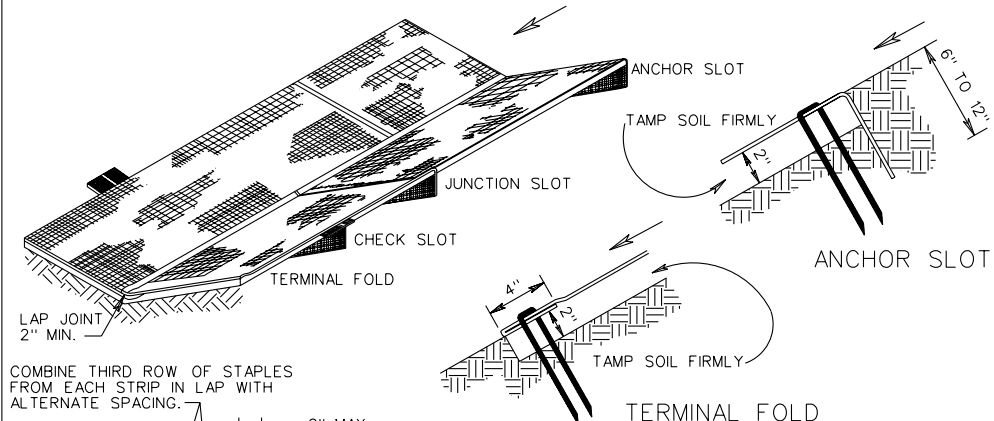

COMBINE THIRD ROW OF STAPLES FROM EACH STRIP IN LAP WITH ALTERNATE SPACING.

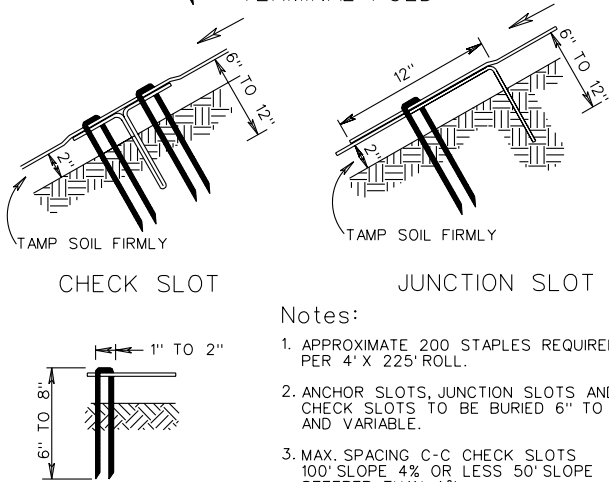
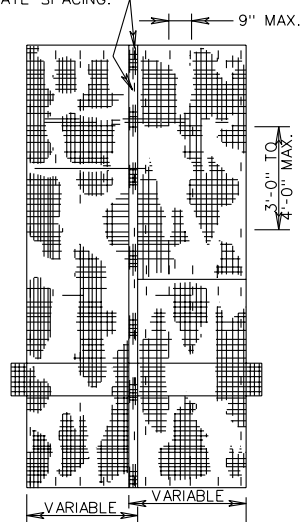

JUTE MESH

Notes:

1. APPROXIMATE 200 STAPLES REQUIRED PER 4' X 225' ROLL.
2. ANCHOR SLOTS, JUNCTION SLOTS AND CHECK SLOTS TO BE BURIED 6" TO 12" AND VARIABLE.
3. MAX. SPACING C-C CHECK SLOTS 100' SLOPE 4% OR LESS 50' SLOPE STEEPER THAN 4%.
4. STAPLES FORMED FROM NO. 8 STEEL WIRE 8" STAPLE MINIMUM LENGTH FOR SANDY SOIL 6" STAPLE MINIMUM LENGTH FOR OTHER SOIL.

GENERAL NOTES:

1. BASIS OF PAYMENT TO BE SQUARE YARDS OF PROTECTIVE COVERING COMPLETE IN PLACE. PROTECTIVE COVERING IS TO BE LOCATED AS INDICATED ON THE PLANS IN ACCORDANCE WITH THE DIMENSIONS SPECIFIED ON TYPICAL SECTION.
2. "T-TOP" STAPLES OR OTHER MANUFACTURER'S DESIGN APPROVED BY THE ENGINEER MAY BE SUBSTITUTED FOR THE STAPLES SHOWN.
3. JUTE MESH OR SOIL RETENTION MAT IN ACCORDANCE WITH THE SPECIFICATIONS MAY BE USED AT THE OPTION OF THE CONTRACTOR.
4. WIDTH OF MATERIAL MAY VARY FROM MINIMUM DIMENSION BY INCREMENTS OF 4 OR 5 FEET.
5. FOR SOURCES OF APPROVED MATERIAL SEE VDOT'S APPROVED PRODUCTS LIST FOR ST'D. EC-2 MATERIAL.

PROTECTIVE COVERING INSTALLATION CRITERIA

114.02

VIRGINIA DEPARTMENT OF TRANSPORTATION

SPECIFICATION REFERENCE

244
606

TYPICAL INSTALLATION AT END OF PIPE

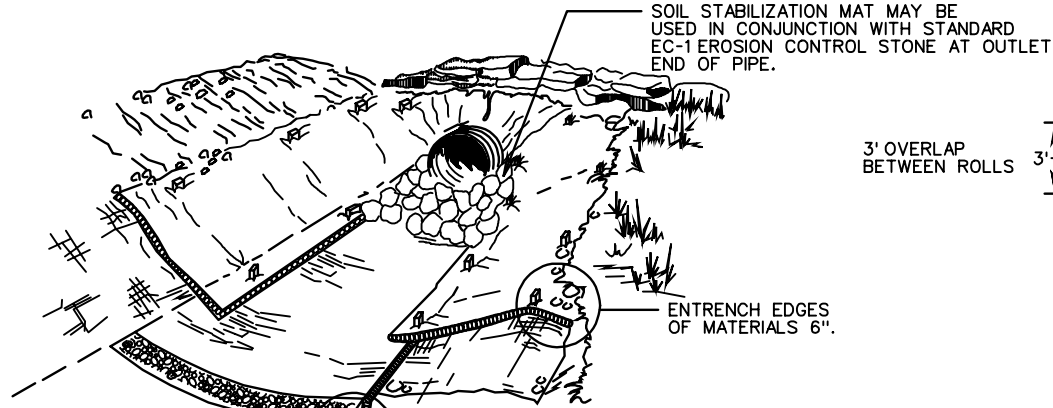

STAKING DETAIL

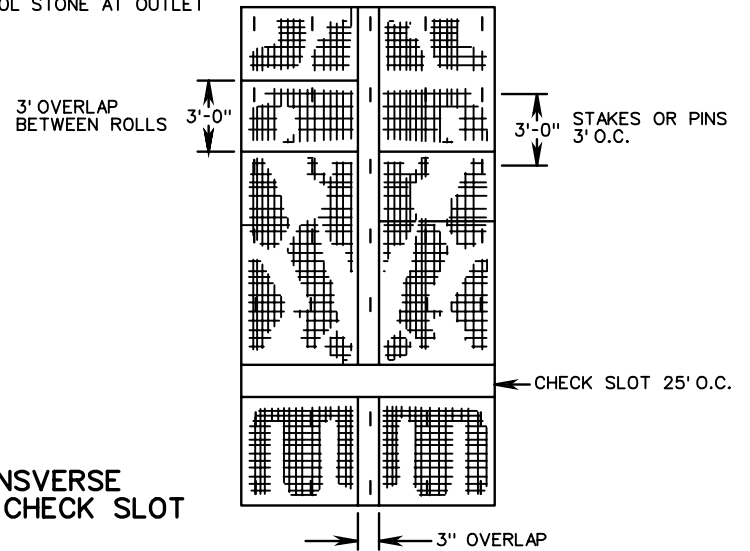

* TRANSVERSE CLOSED CHECK SLOT

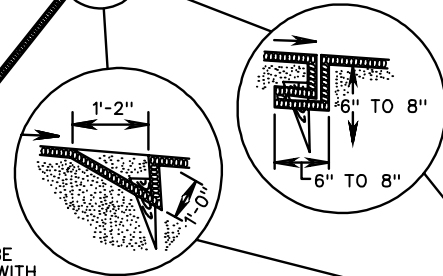

* TRANSVERSE CHECK SLOT TO BE CONSTRUCTED IN ACCORDANCE WITH THE MANUFACTURER'S RECOMMENDATION FOR PREFERRED INSTALLATION.

* TRANSVERSE OPEN CHECK SLOT

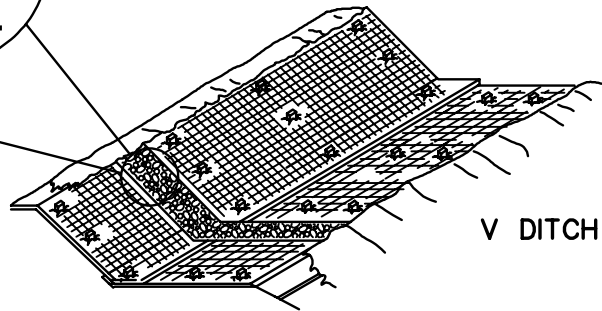

NOTES:

1. STAKES SHALL BE WOOD OR METAL AS RECOMMENDED BY THE MANUFACTURER AND SHALL BE A MINIMUM OF 12" IN LENGTH. IN SANDY SOILS METAL STAKES A MINIMUM OF 18" IN LENGTH SHALL BE USED.
2. SOIL STABILIZATION MAT TYPE A AND B ARE TO BE IN ACCORDANCE WITH THE APPROVED PRODUCTS LIST.
3. SOIL STABILIZATION MAT SHOULD BE INSTALLED TO THE SHOULDER BREAK POINT OR EXISTING GROUND THEN EMBEDDED 6". MATERIAL ON BOTH SIDES OF THE DITCH SHALL BE INSTALLED TO THE SAME ELEVATIONS.
4. IF MORE THAN 3 LINES OF MATERIAL ARE REQUIRED PARALLEL TO THE C OF THE DITCH, MATERIAL SHALL BE INSTALLED PERPENDICULAR TO THE CENTER LINE OF THE DITCH, STARTING AT THE LOWEST C ELEVATION OF THE DITCH.
5. FOR SOURCES OF APPROVED MATERIALS SEE VDOT'S APPROVED PRODUCTS LIST FOR ST'D. EC-3, TYPE A OR B.

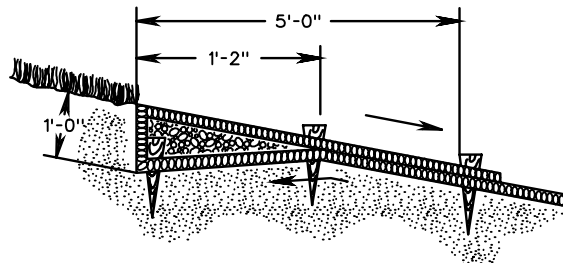

UPSTREAM AND DOWNSTREAM TERMINAL

SPECIFICATION REFERENCE

606
244

SOIL STABILIZATION MAT
DITCH INSTALLATION TYPE A OR B

VIRGINIA DEPARTMENT OF TRANSPORTATION

FILL SLOPE SECTION

DROP STD EC-3 MATERIAL VERTICALLY DOWNSLOPE

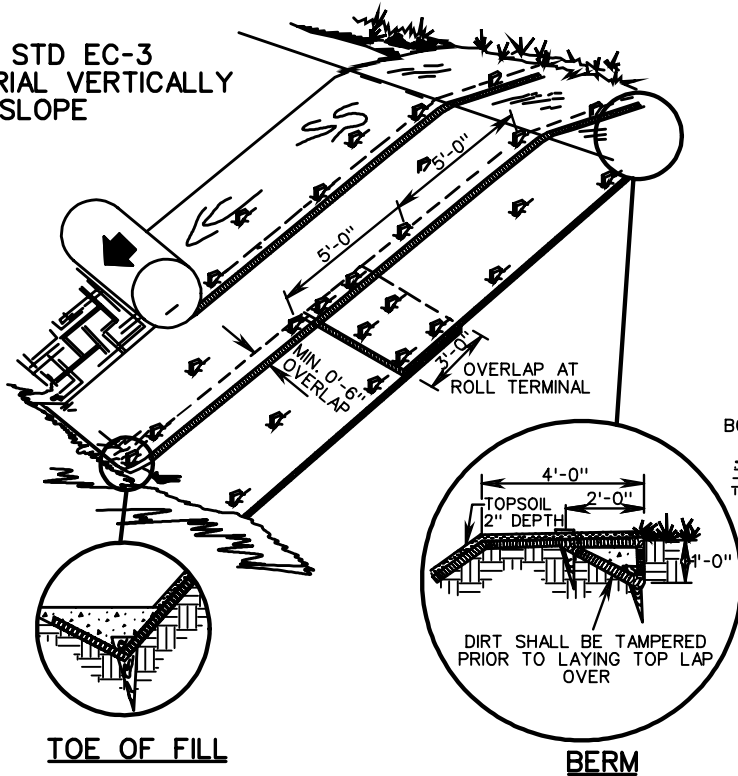

TOE OF FILL
MAINTAIN SLOPE ANGLE

BERM
TRENCH INTO BERM AND
PROGRESS DOWNSLOPE

NOTE:

1. SLOPE SURFACE SHALL BE SMOOTH AND FREE OF ROCKS, LUMPS OF DIRT, GRASS, AND STICKS. MAT SHALL BE PLACED FLAT ON SURFACE FOR PROPER SOIL CONTACT.
2. STAKES SHALL BE WOOD OR METAL AS RECOMMENDED BY THE MANUFACTURER AND SHALL BE A MINIMUM OF 18 INCHES IN LENGTH.
3. BASIS OF PAYMENT SHALL BE SQUARE YARDS OF STANDARD EC-3 (TYPE C) IN PLACE.
4. SOIL STABILIZATION MAT TYPE C SHALL BE IN ACCORDANCE WITH THE APPROVED PRODUCT LIST.
5. TOPSOIL SHALL BE SPREAD TO A UNIFORM THICKNESS PRIOR TO APPLICATION OF SEED AND MULCH.
6. FOR SOURCES OF APPROVED MATERIALS SEE VDOT'S APPROVED PRODUCTS LIST FOR ST'D. EC-3, TYPE C MATERIALS.
7. SLOPES 1/2:1 AND FLATTER SHALL BE BACKFILLED WITH TOPSOIL AT 2 INCH DEPTH. SEED SHALL BE APPLIED TO THE TOPSOIL AND MULCHED WITH TYPE IMULCH.
8. SLOPES STEEPER THAN 1/2:1 SHALL BE SEEDED IMMEDIATELY PRIOR TO INSTALLATION OF ST'D. EC-3 TYPE C MATERIAL.

SLOPE LINING - WET SLOPE

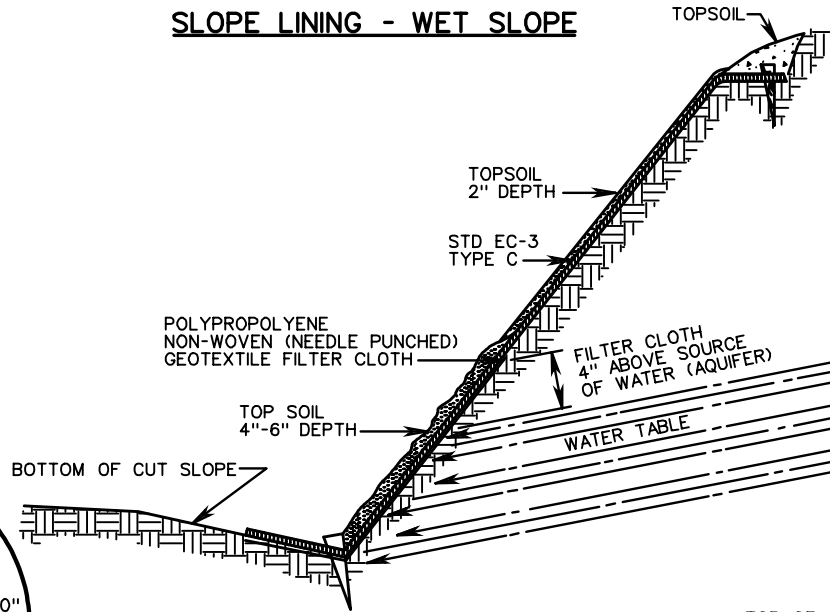

SLOPE LINING - DRY SLOPE

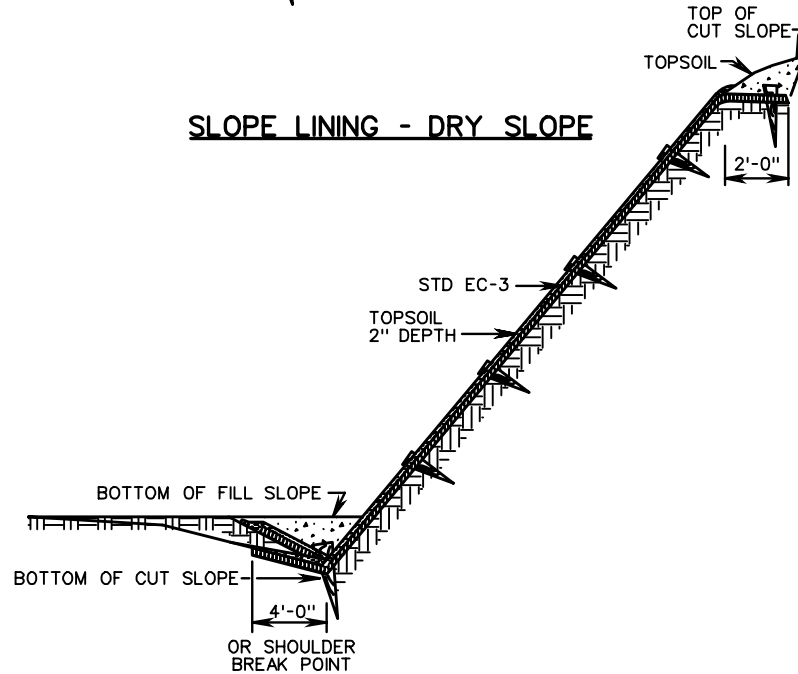

SHEET 3 OF 3

SOIL STABILIZATION MAT - SLOPE INSTALLATION TYPE C

SPECIFICATION
REFERENCE

244
606

TYPICAL DETAIL FOR ROCK CHECK DAM TYPE I

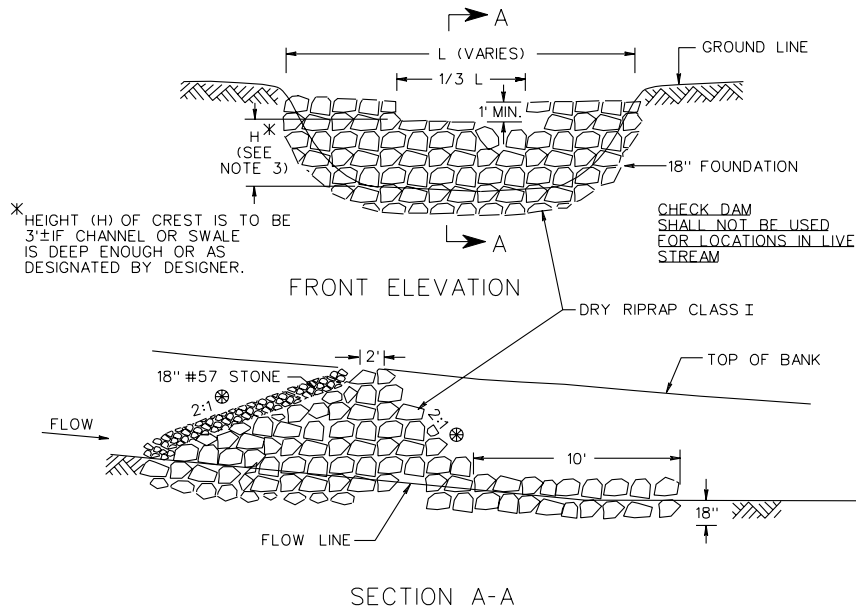

SUGGESTED ROCK CHECK DAM SPACING

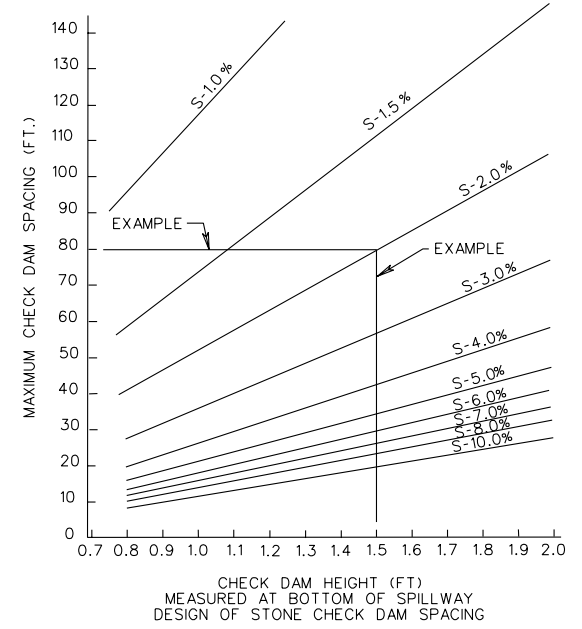

EXAMPLE :

HEIGHT OF STRUCTURE 1.5'
 GRADE 2%
 EXTEND PERPENDICULAR FROM 1.5' HEIGHT TO INTERSECT
 2% GRADE
 EXTEND 90° TO THE LEFT TO DETERMINE SPACING (78'±)

TYPICAL DETAIL FOR ROCK CHECK DAM TYPE II

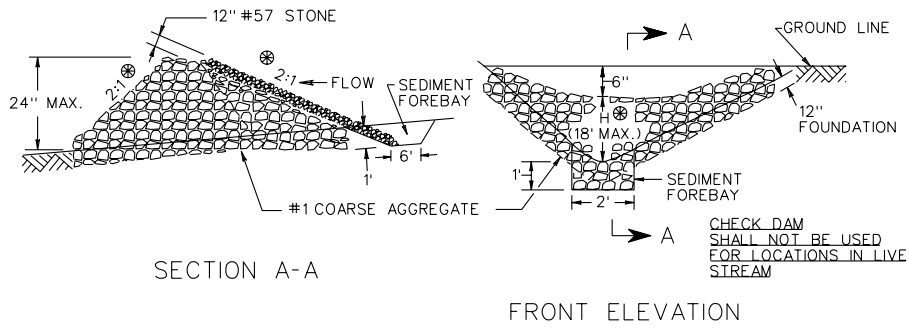

- NOTES:
- ROCK CHECK DAMS THAT ARE DESIGNATED ON THE PLANS AS A STORMWATER MANAGEMENT (SWM) ITEM ARE TO BE LEFT IN PLACE AS A PERMANENT INSTALLATION.
 - WHERE DRAINAGE AREAS EXCEED 1 ACRE OR DITCH GRADE EXCEEDS 3%, A TEMPORARY SEDIMENT FOREBAY SHALL BE INSTALLED WITH MINIMUM DIMENSIONS OF 12" DEPTH, 2' WIDTH AND 6' LENGTH.
 - IF CHECK DAMS IS LOCATED INSIDE CLEAR ZONE AND ADJACENT TO A TRAVELWAY, SLOPE FACING ON COMING TRAFFIC IS TO BE 6:1 AND MAXIMUM H IS TO BE 12".
 - ALTERNATIVE MATERIALS ON VDOT'S SPEL LIST MAY BE SUBSTITUTED AT NO ADDITIONAL COST TO THE DEPARTMENT.

SPECIFICATION REFERENCE
107 303

ROCK CHECK DAMS TYPE I & II

VIRGINIA DEPARTMENT OF TRANSPORTATION

EC-5

TYPICAL DETAIL FOR TEMPORARY FILTER BARRIER/SILT FENCE/CHECK DAM AT CULVERT

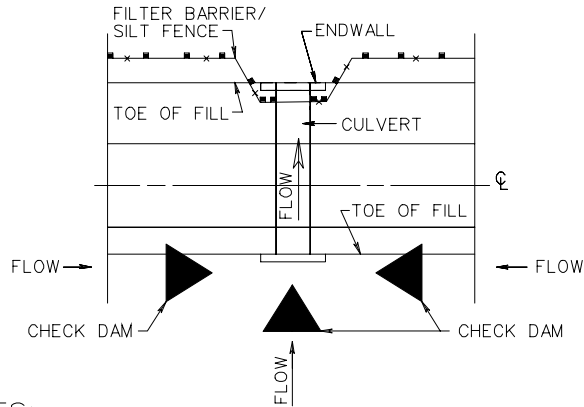

NOTES:

1. IF ANY PORTION OF FILL IS GREATER THAN 5', SILT FENCE IS REQUIRED. IF FILL HEIGHT IS LESS THAN 5', FILTER BARRIER IS REQUIRED.
2. ROCK CHECK DAM IS TO BE CONSTRUCTED IN ACCORDANCE WITH THE ROAD AND BRIDGE SPECIFICATIONS, AND STANDARD EC-4.

TYPICAL DETAIL FOR TEMPORARY SILT FENCE/CHECK DAM AT TOE OF FILL

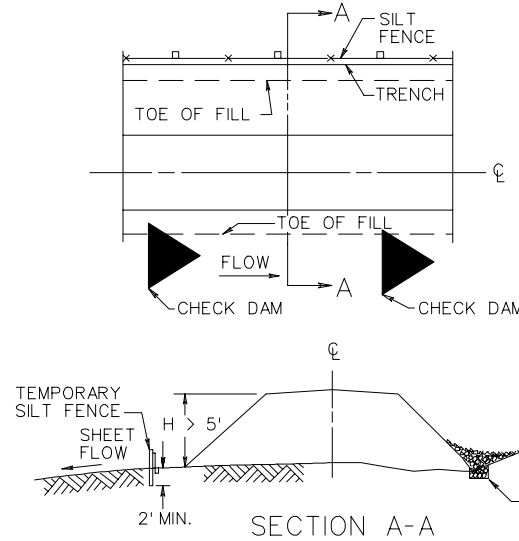

NOTE:

ROCK CHECK DAM IS TO BE CONSTRUCTED IN ACCORDANCE WITH THE ROAD AND BRIDGE SPECIFICATIONS, AND STANDARD EC-4.

TYPICAL DETAIL FOR TEMPORARY FILTER BARRIER/CHECK DAM AT TOE OF FILL

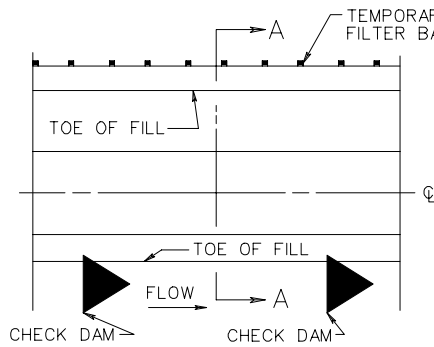

NOTE:

ROCK CHECK DAM IS TO BE CONSTRUCTED IN ACCORDANCE WITH THE ROAD AND BRIDGE SPECIFICATIONS, AND STANDARD EC-4.

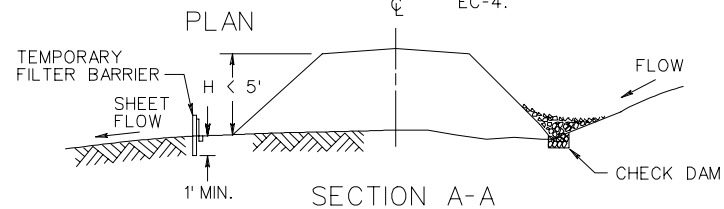

TEMPORARY SILT FENCE

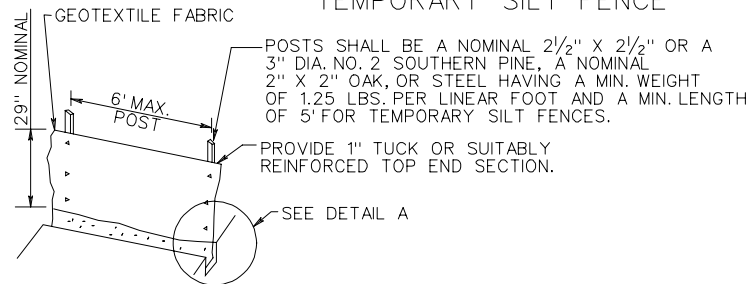

POSTS SHALL BE A NOMINAL 2 1/2" X 2 1/2" OR A 3" DIA. NO. 2 SOUTHERN PINE, A NOMINAL 2" X 2" OAK, OR STEEL HAVING A MIN. WEIGHT OF 1.25 LBS. PER LINEAR FOOT AND A MIN. LENGTH OF 5' FOR TEMPORARY SILT FENCES.

PROVIDE 1" TUCK OR SUITABLY REINFORCED TOP END SECTION.

TEMPORARY FILTER BARRIER

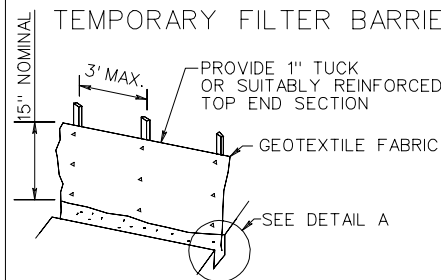

NOTE:

SUPPORTS FOR TEMPORARY FILTER BARRIERS SHALL BE A NOMINAL 1" X 2" OR A 1 1/2" DIA. NO. 2 SOUTHERN PINE OR OAK, OR STEEL HAVING A MIN. WEIGHT OF 1.00 LBS. PER LINEAR FOOT.

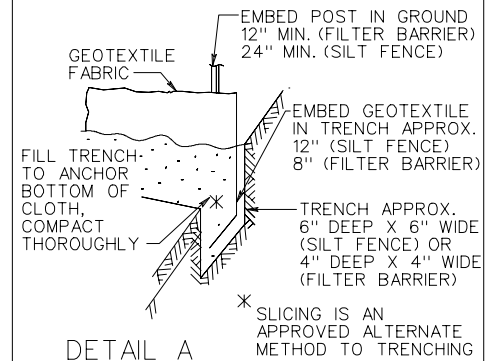

TEMPORARY SILT FENCE AND FILTER BARRIER

SPECIFICATION REFERENCE

107
242
303

REV. 9/06

VIRGINIA DEPARTMENT OF TRANSPORTATION

114.06

DROP INLET SILT TRAP (TYPE A)

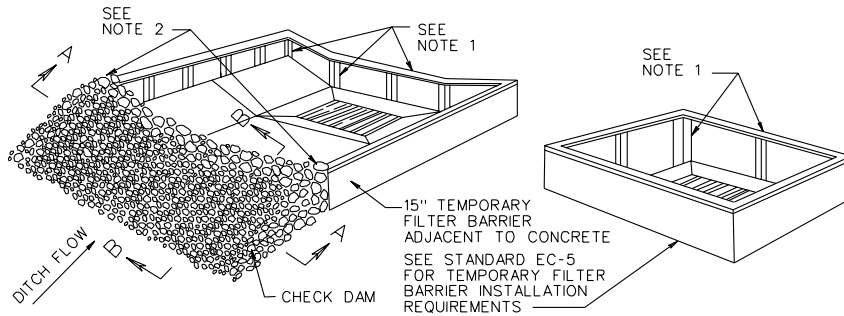

TYPICAL TREATMENT FOR DROP INLET WITH CONCRETE GUTTER

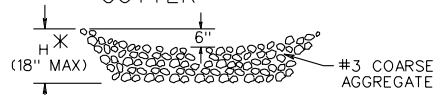

SECTION A-A

* IF CHECK DAM IS LOCATED INSIDE CLEAR ZONE AND ADJACENT TO A TRAVELWAY, SLOPE FACING ON COMING TRAFFIC IS TO BE 6:1 AND MAXIMUM H IS TO BE 12".

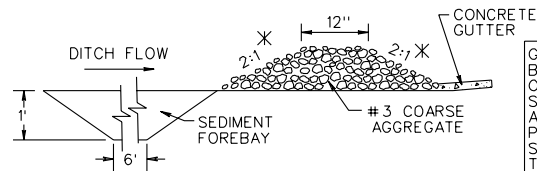

SECTION B-B

NOTES

1. POSTS AND TOP RAIL SHALL BE A NOMINAL 2 1/2" X 2 1/2" OR A 3" DIA. NO. 2 SOUTHERN PINE, A NOMINAL 2" X 2" OAK, OR STEEL HAVING A MIN. WEIGHT OF 1.25 LBS. PER LINEAR FOOT AND A MIN. LENGTH OF 5' FOR TEMPORARY SILT FENCES.
2. END OF FILTER BARRIER TO BE EMBEDDED INTO AGGREGATE.
3. IF A DROP INLET IS LOCATED IN A SAG IN THE DITCH GRADE, A CHECK DAM IS REQUIRED FOR EACH SIDE OF THE INLET THAT RECEIVES DITCH FLOW.
4. WHERE DRAINAGE AREAS EXCEED ONE ACRE OR DITCH GRADE EXCEEDS 3%, A TEMPORARY SEDIMENT FOREBAY SHALL BE INSTALLED WITH MINIMUM DIMENSIONS OF 12" DEPTH, 2' WIDTH AND 6' LENGTH.

TYPICAL TREATMENT FOR DROP INLET WITHOUT CONCRETE GUTTER

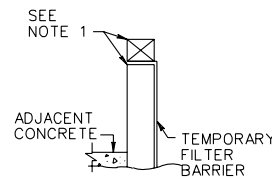

GEOTEXTILE PRODUCTS DESIGNED TO BE INSERTED INTO GRATED DROP INLETS OR DESIGNED TO COVER THE SLOTS OF SLOT DROP INLETS, THAT HAVE BEEN APPROVED FOR USE ON VDOT PROJECTS AND ARE FOUND ON VDOT'S SPEL LIST, MAY BE SUBSTITUTED FOR THE DROP INLET PROTECTION DEVICES DETAILED HEREON.

DROP INLET SILT TRAP TYPE B (BLOCK AND GRAVEL)

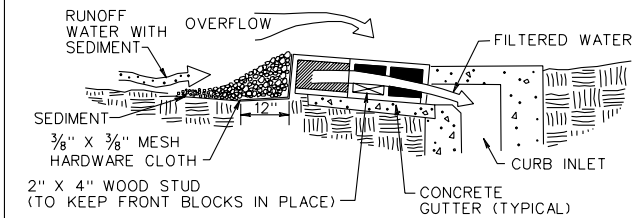
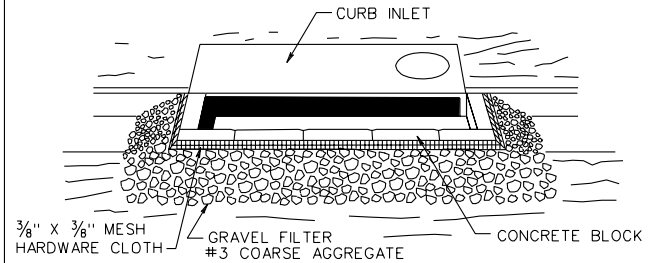

SECTION VIEW

SPECIFIC APPLICATION

THIS METHOD OF INLET PROTECTION IS APPLICABLE AT CURB INLETS WHERE AN OVERFLOW CAPABILITY IS NECESSARY TO PREVENT EXCESSIVE PONDING IN FRONT OF THE STRUCTURE.

ALTERNATE DROP INLET SILT TRAP TYPE B (GRAVEL)

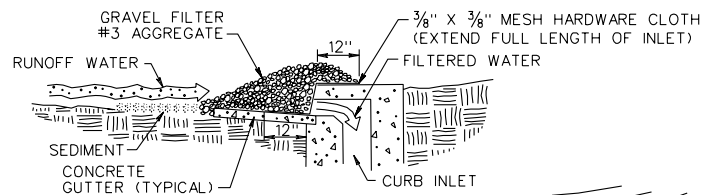

SECTION VIEW

SPECIFIC APPLICATION

THIS METHOD OF INLET PROTECTION IS APPLICABLE AT CURB INLETS WHERE PONDING IN FRONT OF THE STRUCTURE IS NOT LIKELY TO CAUSE INCONVENIENCE OR DAMAGE TO ADJACENT STRUCTURES AND UNPROTECTED AREAS.

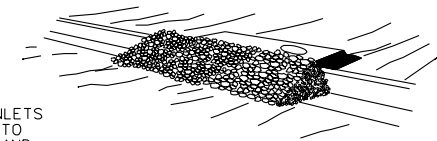

SPECIFICATION REFERENCE

107
242
303

DROP INLET SILT TRAP (TYPE A AND B)

VIRGINIA DEPARTMENT OF TRANSPORTATION

REV. 3/03

114.07

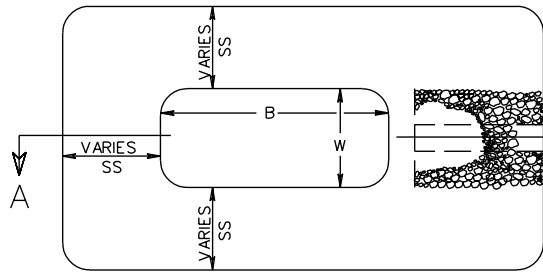

WEIR (ROCK CHECK DAM TYPE 1)
(SEE STANDARD EC-4 OR SHEET
114.05 FOR DETAILS NOT SHOWN)

PLAN VIEW OF TEMPORARY SEDIMENT TRAP

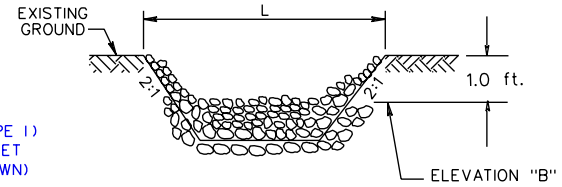

TYPICAL SECTION THRU WEIR
(ROCK CHECK DAM TYPE 1)

NOTES:

1. CHECK DAM IS SHOWN FOR ILLUSTRATION ONLY AND IS NOT INCLUDED IN PAYMENT FOR SEDIMENT TRAP.
2. THE SEDIMENT STORAGE VOLUME SHALL BE 134 CUBIC YARDS/ACRE OF TOTAL CONTRIBUTING DRAINAGE AREA AND SHALL CONSIST OF HALF IN THE FORM OF WET STORAGE AND HALF IN THE FORM OF DRY STORAGE.
3. SEE PLANS FOR DIMENSIONS AND ELEVATIONS.

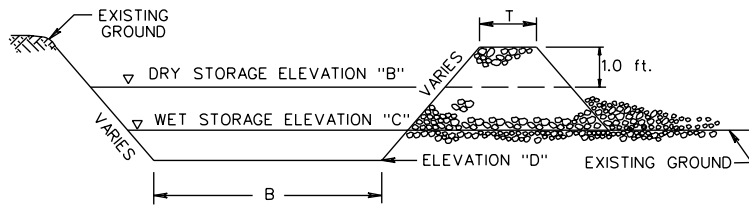

TYPICAL SECTION (A-A) THRU
TEMPORARY SEDIMENT TRAP

TYPICAL SEDIMENT TRAP

VIRGINIA DEPARTMENT OF TRANSPORTATION

SPECIFICATION
REFERENCE

107
303

TYPICAL DEWATERING BASIN

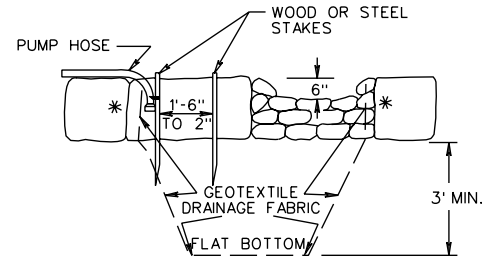
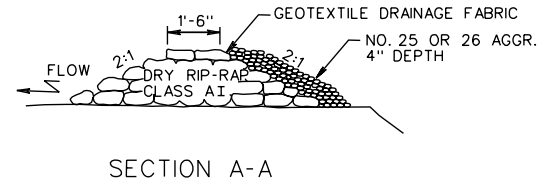
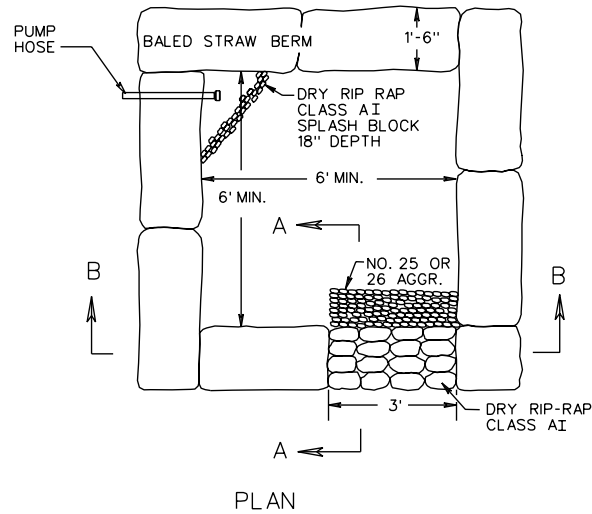

NOTES:

1. DEWATERING BASIN SIZE SHALL BE DETERMINED BY THE FORMULA
 $16 \times \text{GAL./MIN. OF PUMP} = \text{CU. FT. OF STORAGE CAPACITY.}$
2. THIS WORK SHALL CONSIST OF THE CONSTRUCTION OF A DEWATERING BASIN FOR THE PURPOSE OF RECEIVING SEDIMENT-LADENED WATER PUMPED FROM A CONSTRUCTION SITE TO ALLOW FOR FILTRATION BEFORE IT REENTERS THE WATERWAY. PUMPING INTO THESE BASINS SHALL CEASE WHEN THE FLOW FROM THE BASIN BECOMES SEDIMENT-LADENED.
3. SURFACE WATER FLOW SHALL BE DIVERTED AROUND THIS DEVICE.
4. THE OUTFALL FROM THE BASIN(S) SHALL HAVE A STABILIZED CONVEYANCE TO RECEIVING WATERS.
5. ONCE THE DEWATERING BASIN BECOMES FILLED TO HALF OF THE EXCAVATED DEPTH, ACCUMULATED SEDIMENT SHALL BE REMOVED AND DISPOSED OF IN AN APPROVED DISPOSAL AREA OUTSIDE OF THE 100-YEAR FLOODPLAIN UNLESS OTHERWISE APPROVED ON THE PLANS.
6. SEDIMENT CONTROL DEVICES ARE TO REMAIN IN PLACE UNTIL ALL DISTURBED AREAS ARE STABILIZED AND THE ENGINEER APPROVES THEIR REMOVAL. GROUND CONTOURS SHALL BE RETURNED TO THEIR ORIGINAL CONDITION UNLESS SPECIFICALLY APPROVED OTHERWISE BY THE ENGINEER.
7. SYNTHETIC PRODUCTS APPROVED BY VDOT'S NEW PRODUCTS COMMITTEE AS A SUBSTITUTE MAY BE USED IN LIEU OF THIS DESIGN. HOWEVER, VDOT WILL ONLY COMPENSATE THE CONTRACTOR UP TO THE BID PRICE PER EACH AT EACH SITE.

* GEOTEXTILE DRAINAGE FABRIC TO COVER INSIDE FACE OF BALED STRAW BERM.

SPECIFICATION REFERENCE	<p>DEWATERING BASIN</p> <p>VIRGINIA DEPARTMENT OF TRANSPORTATION</p>	
107 303		114.09

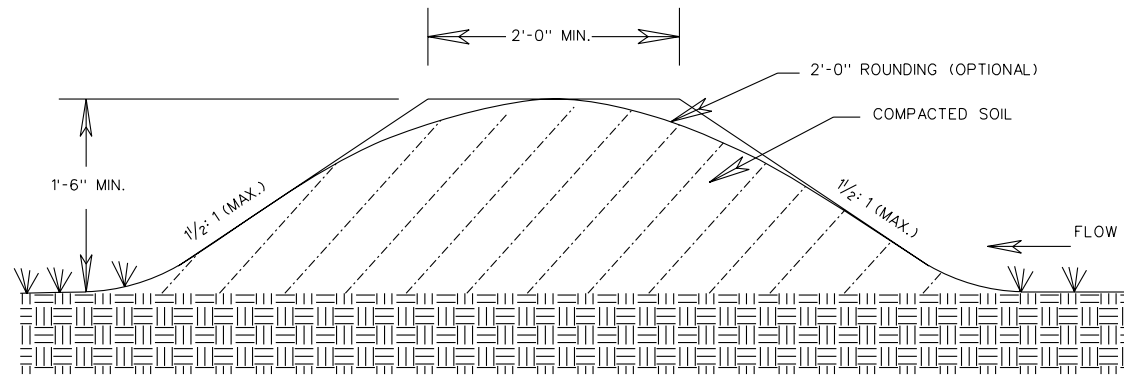

TEMPORARY DIVERSION DIKE

NOTE:

1. THE CHANNEL CREATED BEHIND THE DIKE SHALL HAVE A POSITIVE GRADE TO A STABILIZED OUTLET. THE CHANNEL SHALL BE STABILIZED, AS NECESSARY, TO PREVENT EROSION.
2. TEMPORARY DIVERSION DIKE WILL BE MEASURED AND PAID FOR IN ACCORDANCE WITH SECTION 303 OF THE SPECIFICATIONS.

TEMPORARY DIVERSION DIKE

VIRGINIA DEPARTMENT OF TRANSPORTATION

SPECIFICATION
REFERENCE

303

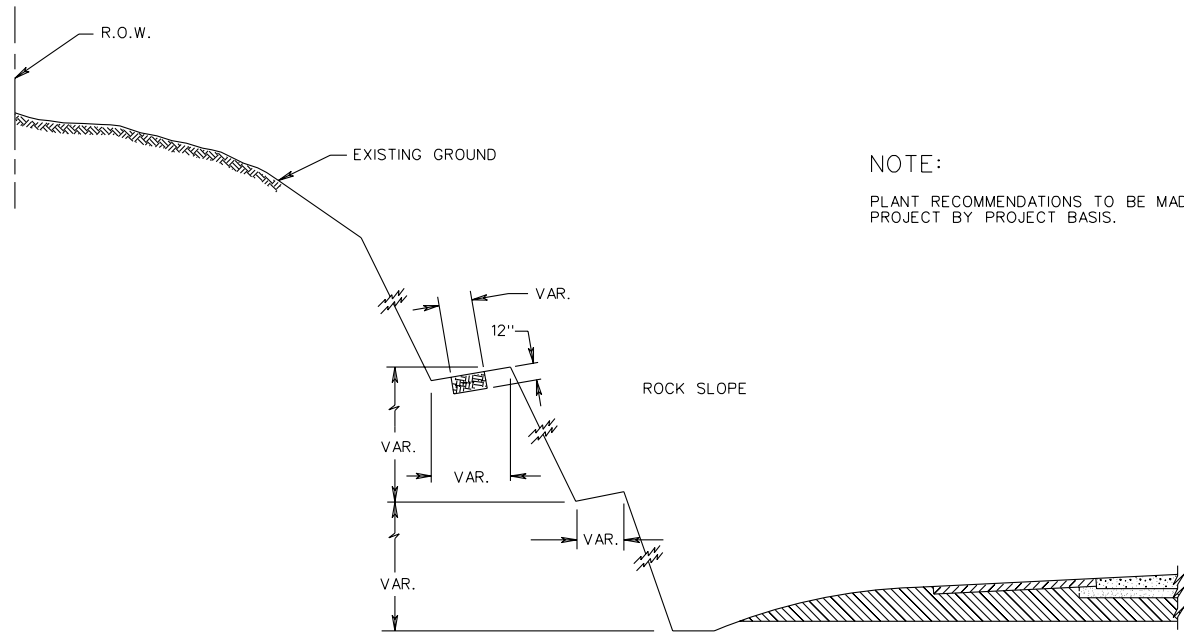

NOTE:
PLANT RECOMMENDATIONS TO BE MADE ON A
PROJECT BY PROJECT BASIS.

SECTION A-A

THIS SECTION IS TO BE USED AS A GUIDE ONLY.
EACH ROCK CUT SHOULD RECEIVE INDIVIDUAL INVESTIGATION.

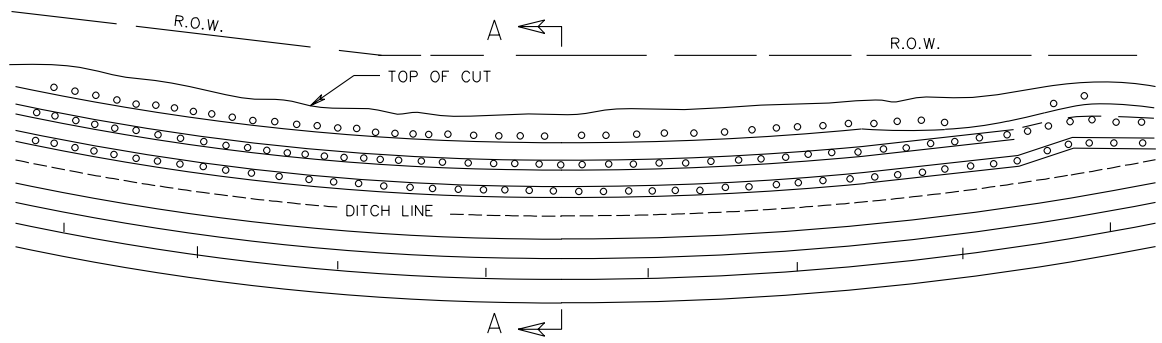

SPECIFICATION REFERENCE
NONE

TYPICAL METHOD FOR BENCH PLANTING ON ROCK CUT SECTION

VIRGINIA DEPARTMENT OF TRANSPORTATION

L-3A

CUT SLOPES STEEPER THAN 2:1 SHALL BE GROOVED IN ACCORDANCE WITH DETAILS SHOWN.

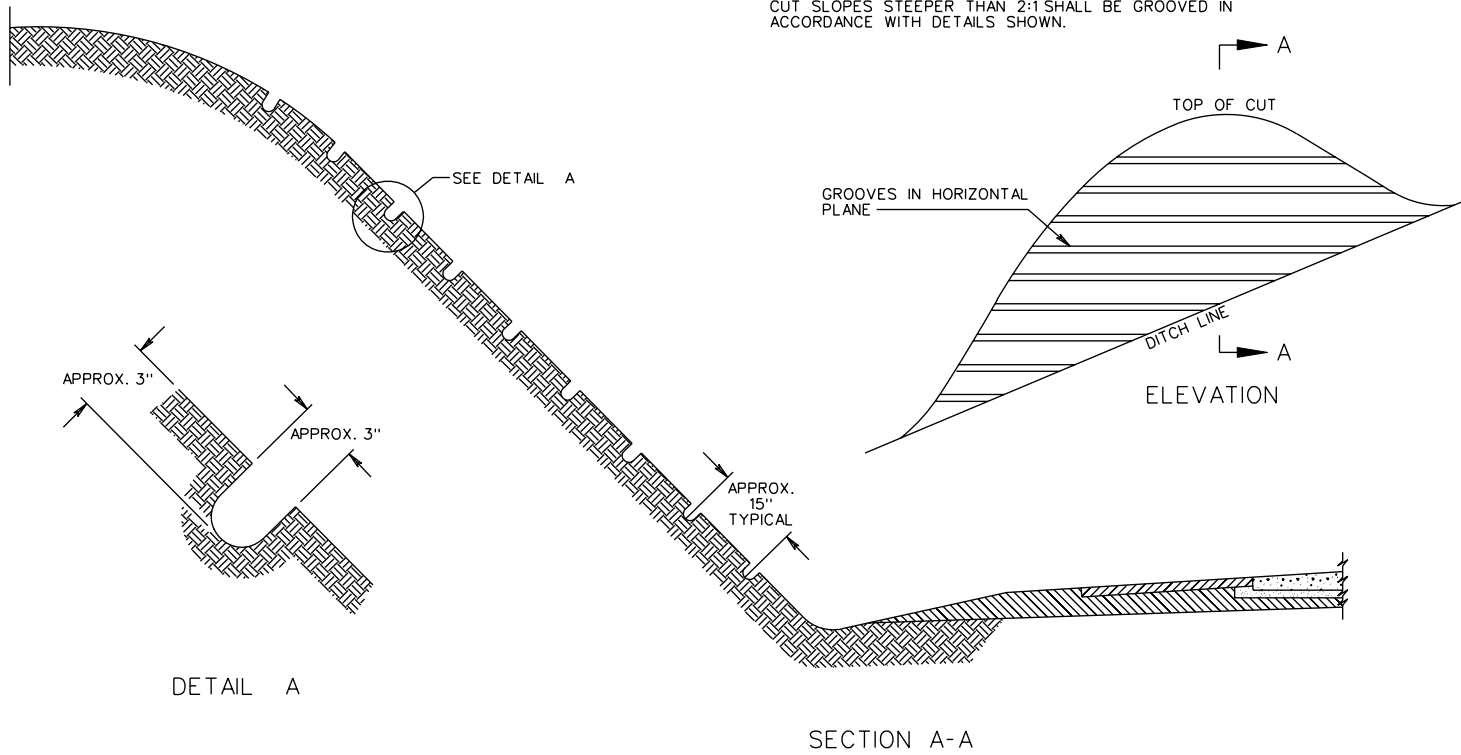

TYPICAL METHOD FOR HORIZONTAL GROOVING CUT SLOPES

VIRGINIA DEPARTMENT OF TRANSPORTATION

SPECIFICATION REFERENCE

303

1201.02

OUTSIDE ROAD DITCHES

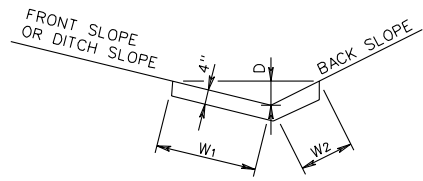

TYPE	D	FRONT SLOPE	BACK SLOPE	W1	W2	K	SQ. YDS. SURFACE AREA/LIN. FT.
A1	6"	6:1	4:1	3'-0"	2'-1"	48	0.565
A1	8"	6:1	4:1	4'-1"	2'-9"	104	0.759
A2	6"	6:1	3:1	3'-0"	1'-7"	42	0.509
A2	8"	6:1	3:1	4'-1"	2'-1"	92	0.685
A3	6"	6:1	2:1	3'-0"	1'-2"	38	0.463
A3	8"	6:1	2:1	4'-1"	1'-6"	82	0.620
B1	6"	4:1	4:1	2'-1"	2'-1"	38	0.463
B1	8"	4:1	4:1	2'-9"	2'-9"	82	0.611
B2	8"	4:1	3:1	2'-9"	2'-1"	72	0.537
B2	10"	4:1	3:1	3'-5"	2'-8"	130	0.676
B3	8"	4:1	2:1	2'-9"	1'-6"	60	0.472
B3	10"	4:1	2:1	3'-5"	1'-10"	111	0.583
B4	8"	4:1	1 1/2 : 1	2'-9"	1'-2"	55	0.435
B4	10"	4:1	1 1/2 : 1	3'-5"	1'-6"	101	0.546
C1	8"	3:1	2:1	2'-1"	1'-6"	50	0.398
C1	10"	3:1	2:1	2'-8"	1'-10"	92	0.500
C2	10"	3:1	1 1/2 : 1	2'-8"	1'-6"	80	0.463
C3	10"	3:1	1:1	2'-8"	1'-2"	70	0.426

MEDIAN DITCH

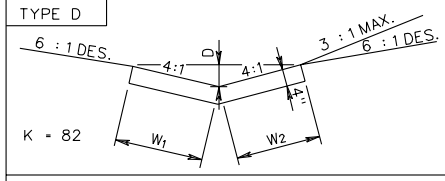

D - DEPTH	W1	W2	SQ. YDS. SURFACE AREA PER LIN. FT.
8"	2'-9"	2'-9"	0.611

DITCH AT TOE OF FILL OR TOP OF CUT

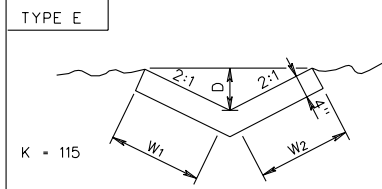

D	W1	W2	SQ. YDS. SURFACE AREA PER LIN. FT.
12"	2'-3"	2'-3"	0.500

CURTAIN WALL DETAIL

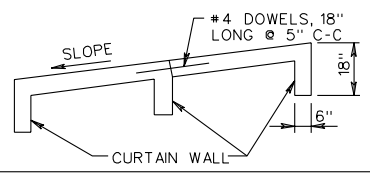

CURTAIN WALL TO BE LOCATED AT BEGINNING AND ON THE LOWER END OF EACH EXPANSION JOINT.

PLAN FOR TRANSITION OF PAVED MEDIAN DITCH TO MEDIAN DROP INLET GUTTER

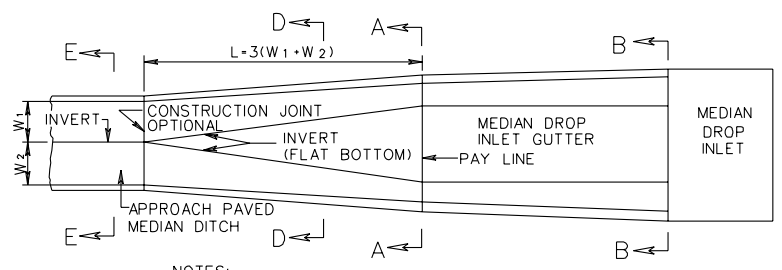

NOTES:
 FOR SECTION A-A AND B-B SEE STANDARDS DI-7, 7A AND 7B.
 TRADITIONAL PORTION OF PAVED DITCH TO BE PAID FOR AT THE SAME PRICE BID PER SQ. YARD FOR APPROACH PAVED MEDIAN DITCH.
 STANDARD PG-2A DITCHES TO BE CLASS A3 CONCRETE.

ALTERNATE METHOD OF FORMING DITCHES

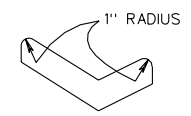
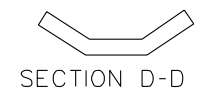

NOTE:
 ALL DITCHES MAY BE CONSTRUCTED WITH VERTICAL SIDES AT THE OPTION OF THE CONTRACTOR.

SPECIFICATION REFERENCE
502

STANDARD PAVED DITCHES

VIRGINIA DEPARTMENT OF TRANSPORTATION

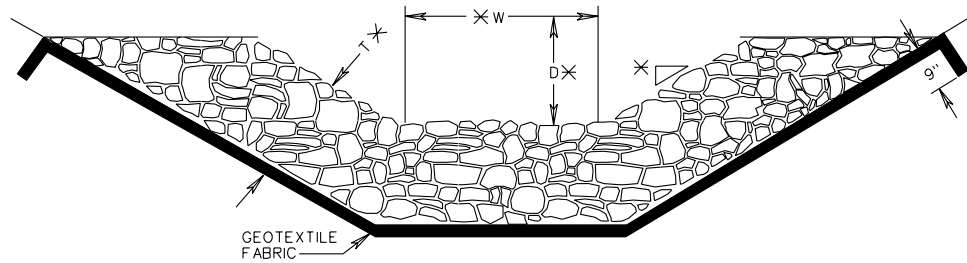

TYPE I
RIPRAP DITCH PROTECTION

MINIMUM THICKNESS "T"

RIP RAP CLASS	MINIMUM "T"
CLASS AI	20"
CLASS I	26"
CLASS II	38"
CLASS III	53"

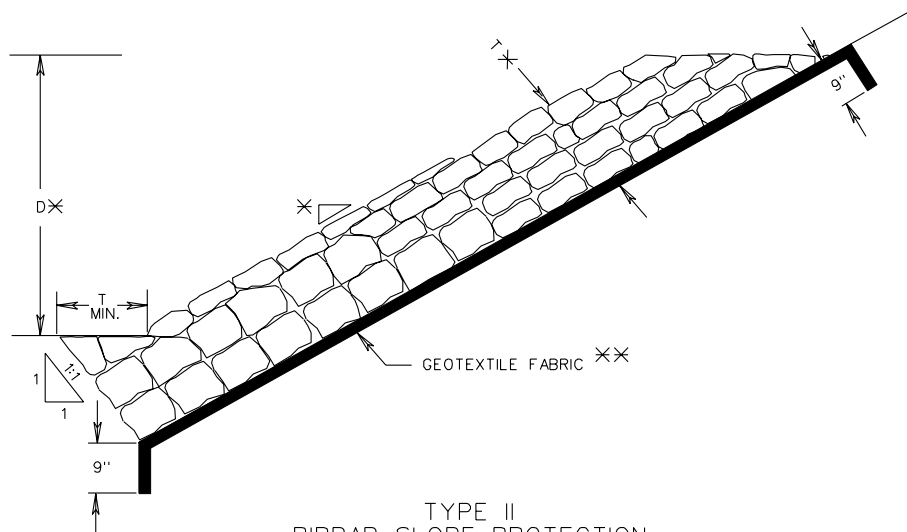

TYPE II
RIPRAP SLOPE PROTECTION

NOTES:

- ×× RIP RAP BEDDING MATERIAL
- GEOTEXTILE FABRIC TO BE PROVIDED UNDER ALL RIPRAP INSTALLATIONS CLASS AI, CLASS I AND CLASS II UNLESS OTHERWISE NOTED ON THE PLANS OR DIRECTED BY THE ENGINEER.
- RIPRAP INSTALLATIONS OF CLASS III SHALL HAVE AN INTERMEDIATE AGGREGATE BEDDING LAYER(S) AS SPECIFIED ON THE PLANS BASED ON GEOTECHNICAL RECOMMENDATIONS.
- × SEE TYPICAL SECTION SHOWN ON PLANS FOR SIDE SLOPE, BOTTOM WIDTH AND DEPTH OF CHANNEL AND RIPRAP THICKNESS.

SPECIFICATION REFERENCE
245 414

STANDARD RIP RAP DITCH & SLOPE PROTECTION
PG-3

 INDICATES CHANNEL WHERE WIRE MESH REINFORCEMENT IS NOT REQUIRED.

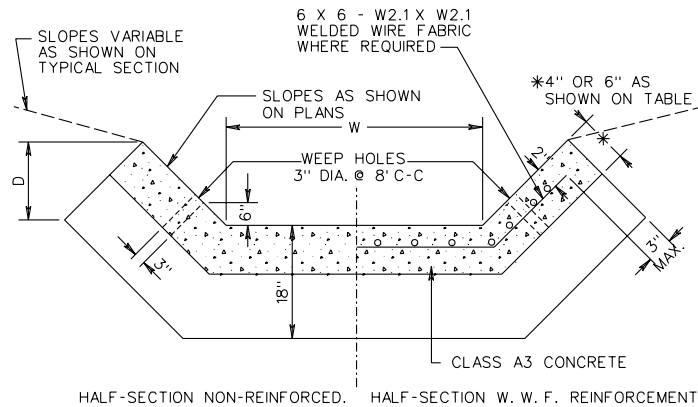



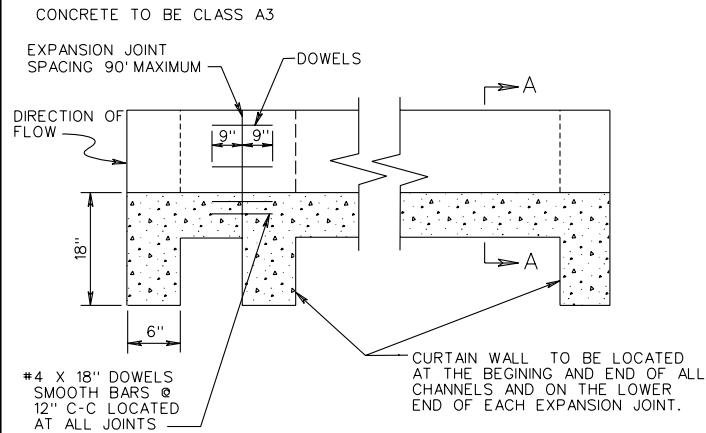





SECTION A-A



ELEVATION

SQUARE YARDS PER LIN. FT. OF PAVED CHANNEL

CONC. THICK-NESS	D	W									
		1'	2'	3'	4'	5'	6'	7'	8'	9'	10'
1:1 SIDE SLOPES											
4"	1'	 0.425	0.536	0.648	0.759	0.870	0.981	1.092	1.203	1.314	1.425
	2'	 0.740	0.851	0.962	1.073	1.184	1.295	1.406	1.517	1.629	1.740
	3'	 1.054	1.165	1.276	1.387	1.498	1.609	1.721	1.832	1.943	2.054
	4'	1.368	1.479	1.590	1.702	1.813	1.924	2.035	2.146	2.257	2.368
6"	5'	1.682	1.794	1.905	2.016	2.127	2.238	2.349	2.460	2.571	2.682
	6'	1.997	2.108	2.219	2.330	2.441	2.552	2.663	2.774	2.886	2.997
	7'	2.311	2.422	2.533	2.644	2.755	2.866	2.977	3.089	3.200	3.311
	8'	2.625	2.736	2.848	2.959	3.070	3.181	3.292	3.403	3.514	3.625
	9'	2.940	3.051	3.162	3.273	3.384	3.495	3.606	3.717	3.828	3.939
	10'	3.254	3.365	3.476	3.587	3.698	3.809	3.920	4.032	4.143	4.254
1.5:1 SIDE SLOPES											
4"	1'	 0.512	0.623	0.734	0.845	0.956	1.067	1.178	1.290	1.401	1.512
	2'	 0.912	1.023	1.135	1.246	1.357	1.468	1.579	1.690	1.801	1.912
	3'	 1.313	1.424	1.535	1.646	1.757	1.869	1.980	2.091	2.202	2.313
	4'	1.714	1.825	1.936	2.047	2.158	2.269	2.380	2.491	2.602	2.714
6"	5'	2.114	2.225	2.336	2.448	2.559	2.670	2.781	2.892	3.003	3.114
	6'	2.515	2.626	2.737	2.848	2.959	3.070	3.181	3.293	3.404	3.515
	7'	2.915	3.027	3.138	3.249	3.360	3.471	3.582	3.693	3.804	3.915
	8'	3.316	3.427	3.538	3.649	3.760	3.872	3.983	4.094	4.205	4.316
	9'	3.717	3.828	3.939	4.050	4.161	4.272	4.383	4.494	4.606	4.717
	10'	4.117	4.228	4.340	4.451	4.562	4.673	4.784	4.895	5.006	5.117
2:1 SIDE SLOPES											
4"	1'	 0.608	0.719	0.830	0.941	1.052	1.164	1.275	1.386	1.497	1.608
	2'	 1.105	1.216	1.327	1.438	1.549	1.660	1.772	1.883	1.994	2.105
	3'	 1.602	1.713	1.824	1.935	2.046	2.157	2.268	2.380	2.491	2.602
	4'	2.099	2.210	2.321	2.432	2.543	2.654	2.765	2.876	2.988	3.099
6"	5'	2.596	2.707	2.818	2.929	3.040	3.151	3.262	3.373	3.485	3.596
	6'	3.093	3.204	3.315	3.426	3.537	3.648	3.759	3.870	3.981	4.093
	7'	3.589	3.701	3.812	3.923	4.034	4.145	4.256	4.367	4.478	4.589
	8'	4.086	4.197	4.309	4.420	4.531	4.642	4.753	4.864	4.975	5.086
	9'	4.583	4.694	4.805	4.917	5.028	5.139	5.250	5.361	5.472	5.583
	10'	5.080	5.191	5.302	5.413	5.525	5.636	5.747	5.858	5.969	6.080

NOTES:

DEPTH (D) AND WIDTH (W) TO BE AS SHOWN ON PLANS.
 WEEP HOLES ARE TO BE PROVIDED ON ALL CHANNELS WHERE W IS EQUAL TO OR GREATER THAN 4' AND D IS EQUAL TO OR GREATER THAN 2'.
 WEEP HOLE WITH 12" X 12" PLASTIC HARDWARE CLOTH, 1/4" MESH OR GALVANIZED STEEL WIRE DIAMETER 0.03 INCH, NUMBER 4 MESH, HARDWARE CLOTH ANCHORED FIRMLY TO THE BOTTOM OF THE CHANNEL.

SPECIFICATION REFERENCE

502

STANDARD PAVED DITCHES

VIRGINIA DEPARTMENT OF TRANSPORTATION

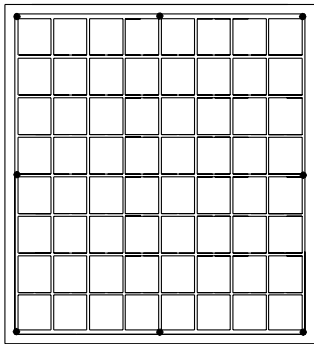

PLAN VIEW

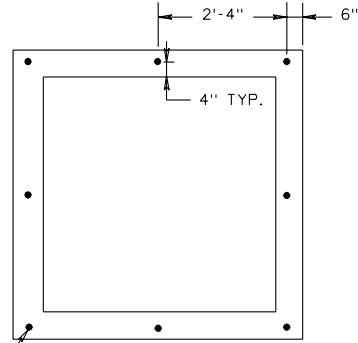

PLAN VIEW
(TRASH RACK NOT SHOWN)
3/8" DIA. X 6" LG. ADHESIVE BOLTS
W/FLAT WASHERS AND SELF
LOCKING NUTS TYPICAL 8 PLACES.

NOTES:

1. COST OF TRASH RACK AND DEBRIS RACK ARE TO BE INCLUDED IN THE BID PRICE FOR THE STORMWATER MANAGEMENT DRAINAGE STRUCTURE.
2. STRUCTURE MAY BE PRECAST OR CAST IN PLACE. SEE SHEET 2 OF 2 FOR DETAILS ON PRECAST STRUCTURE.
3. WEEP HOLES SHALL NOT BE PROVIDED.
4. STEPS ARE TO BE PROVIDED WHEN HEIGHT OF STRUCTURE IS 4'-0" OR GREATER ABOVE INVERT OF OUTLET PIPE. FOR STEP DETAILS SEE STANDARD ST-1.
5. FOR DETAILS ON METAL PLATE, DEBRIS RACK AND TRASH RACK SEE STANDARD SWM-DR.
6. MARK HEIGHT OF STRUCTURE, IN BLACK, WITH 4" HIGH NUMERALS AND 1" WIDE HORIZONTAL STRIPES AT 1" INTERVALS FROM INVERT OF WATER QUALITY ORIFICE (ALL VISIBLE SIDES).
7. THE PERMANENT STORMWATER MANAGEMENT DRAINAGE STRUCTURE, STANDARD SWM-1 MAY BE MODIFIED WHERE THE STORMWATER MANAGEMENT BASIN IS TO BE USED AS A TEMPORARY SEDIMENT BASIN DURING PROJECT CONSTRUCTION. SEE STANDARD SWM-DR, SHEET 1 OF 5, FOR TEMPORARY MODIFICATION DETAILS.
8. THE SIZE OF THE WATER QUALITY ORIFICE SHALL BE SPECIFIED ON THE PLANS. ADDITIONAL OPENINGS IN THE STORMWATER MANAGEMENT DRAINAGE STRUCTURE TO BE PROVIDED WHEN SPECIFIED ON THE PLANS.

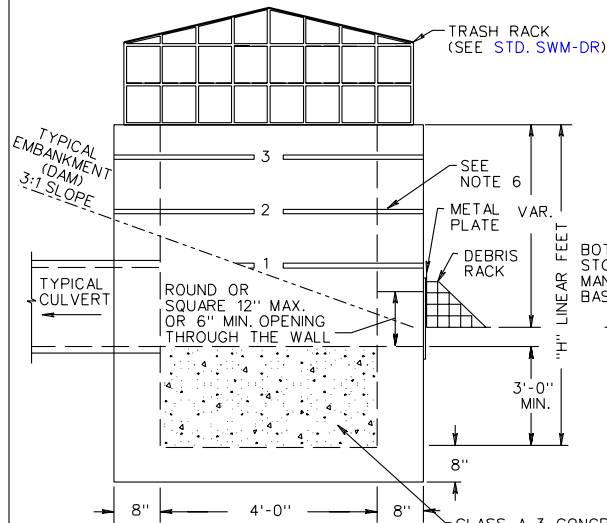

SIDE VIEW
SWM DRAINAGE STRUCTURE

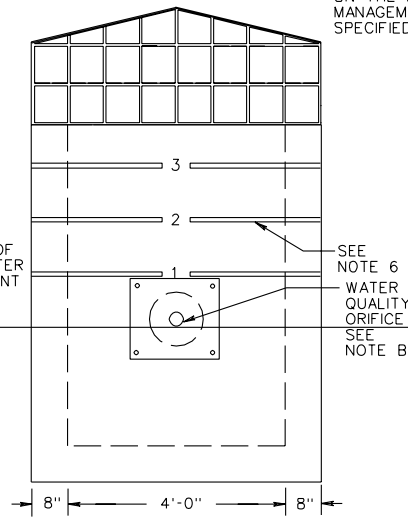

FRONT VIEW
(DEBRIS RACK NOT SHOWN)

CLASS A-3 CONCRETE TO BE USED TO FILL SWM DRAINAGE STRUCTURE TO INVERT OF OUTLET PIPE.

APPROXIMATE QUANTITIES
CAST-IN-PLACE CLASS A-3 CONCRETE TO BE USED.
MAXIMUM DEPTH (H) TO BE 12'-8".

PIPE SIZE	12"	15"	18"	24"	30"	36"	42"
MINIMUM DEPTH H	5'-0"	5'-3/4"	5'-6 1/2"	6'-1"	6'-7 1/2"	7'-2"	7'-8 1/2"
CU. YDS. CONCRETE	2.665	2.773	2.878	3.078	3.624	3.437	3.598

INCREMENT PER FOOT OF ADDITIONAL DEPTH "H" = 0.461 CU. YDS.

SHEET 1 OF 2

SPECIFICATION REFERENCE

302

CAST IN PLACE STORMWATER MANAGEMENT DRAINAGE STRUCTURE

VIRGINIA DEPARTMENT OF TRANSPORTATION

REV. 3/03

116.01

SWM-1

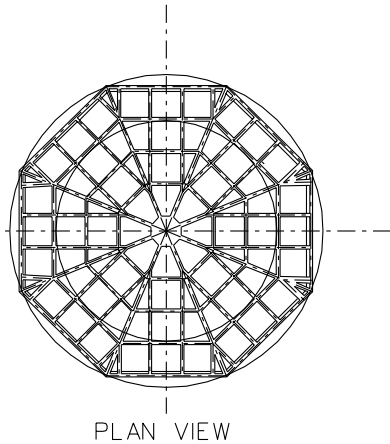

NOTES:

1. COST OF TRASH RACK AND DEBRIS RACK ARE TO BE INCLUDED IN THE PRICE BID FOR THE STORMWATER MANAGEMENT DRAINAGE STRUCTURE.
2. STRUCTURE MAY BE PRECAST OR CAST IN PLACE. SEE SHEET 1 OF 2 FOR DETAILS ON CAST IN PLACE STRUCTURE.
3. WEEP HOLES SHALL NOT BE PROVIDED. ANY LIFT HOLES SHALL BE PLUGGED.
4. STEPS ARE TO BE PROVIDED WHEN HEIGHT OF STRUCTURE IS 4'-0" OR GREATER ABOVE INVERT OF OUTLET PIPE. FOR STEP DETAILS SEE STANDARD ST-1.
5. SEE STANDARD SWM-DR FOR DETAILS ON PLATE, DEBRIS RACK AND TRASH RACK.
6. MARK HEIGHT OF STRUCTURE, IN BLACK, WITH 4" HIGH NUMERALS AND 1" WIDE HORIZONTAL STRIPES AT 1' INTERVALS FROM INVERT OF WATER QUALITY ORIFICE (ALL VISIBLE SIDES).
7. THE PERMANENT STORMWATER MANAGEMENT DRAINAGE STRUCTURE, STANDARD SWM-1 MAY BE MODIFIED WHERE THE STORMWATER MANAGEMENT BASIN IS TO BE USED AS A TEMPORARY SEDIMENT BASIN DURING PROJECT CONSTRUCTION. SEE STANDARD SWM-DR, SHEET 1 OF 5 FOR TEMPORARY MODIFICATION DETAILS.
8. THE SIZE OF THE WATER QUALITY ORIFICE SHALL BE SPECIFIED ON THE PLANS. ADDITIONAL OPENINGS IN THE STORMWATER MANAGEMENT DRAINAGE STRUCTURE TO BE PROVIDED WHEN SPECIFIED ON THE PLANS.

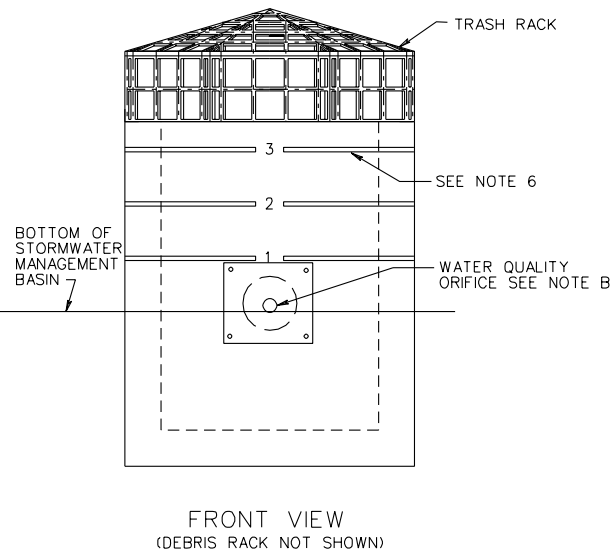
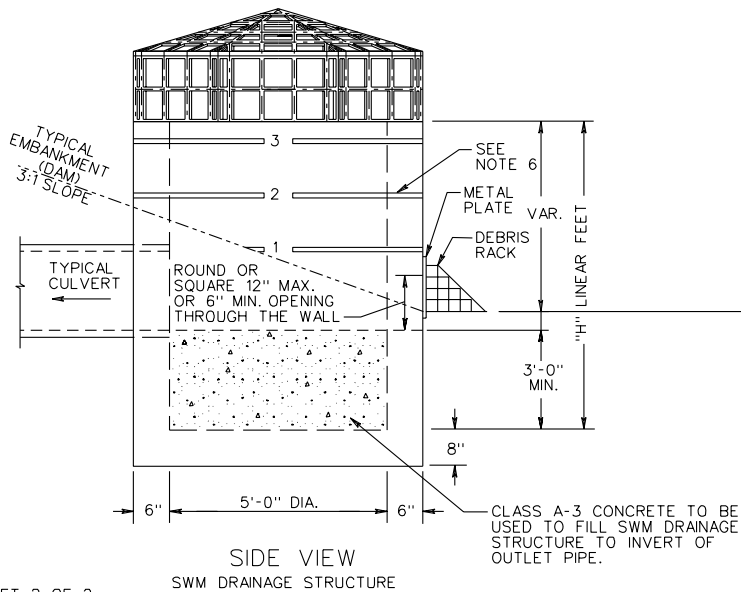

SHEET 2 OF 2

PRECAST STORMWATER MANAGEMENT DRAINAGE STRUCTURE

REV. 3/03

VIRGINIA DEPARTMENT OF TRANSPORTATION

116.02

SPECIFICATION
REFERENCE

105
302

SWM-DR

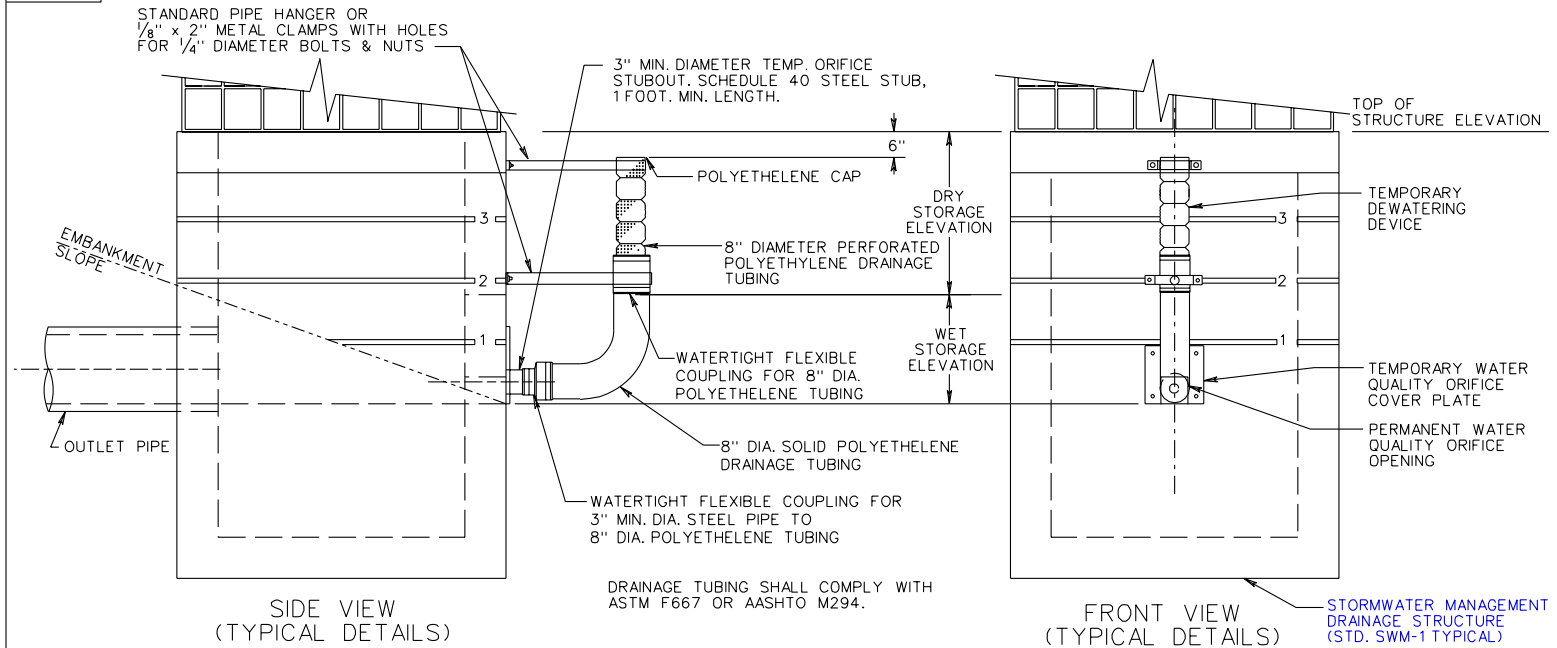

NOTES:

1. THESE DETAILS ARE TO BE USED TO MODIFY THE PERMANENT STORMWATER MANAGEMENT DRAINAGE STRUCTURE WHERE THE STORMWATER MANAGEMENT BASIN IS TO BE USED FOR A TEMPORARY SEDIMENT BASIN DURING PROJECT CONSTRUCTION.
2. GRADE STORMWATER MANAGEMENT BASIN AS SHOWN IN PLANS.
3. ALL OPENINGS (IF ANY) IN SIDE OF STRUCTURE (OTHER THAN PERMANENT WATER QUALITY ORIFICE) ARE TO BE COVERED WITH SOLID METAL PLATES WHILE THE BASIN IS BEING USED FOR SEDIMENT CONTROL.
4. DEWATERING DEVICE AND COMPONENTS AND TEMPORARY METAL PLATES (IF ANY), AS SHOWN IN THE DETAIL, ARE TO BE REMOVED AND PERMANENT STEEL PLATE WITH WATER QUALITY ORIFICE IS TO BE INSTALLED WHEN BASIN IS NO LONGER NEEDED FOR SEDIMENT CONTROL.
5. SIMILAR DEVICE MAY ALSO BE USED ON OTHER STORMWATER MANAGEMENT DRAINAGE STRUCTURES.
6. COST OF TEMPORARY DEWATERING DEVICE AND TEMPORARY METAL PLATES (IF ANY) SHALL BE INCLUDED IN THE BID PRICE FOR STORMWATER MANAGEMENT DRAINAGE STRUCTURE.
7. THE TEMPORARY 8" DIA. POLYETHYLENE DRAINAGE TUBING IS TO BE SOLID FOR THE LENGTH BELOW WET STORAGE ELEVATION AND IS TO BE PERFORATED ABOVE THE WET STORAGE ELEVATION. THE COUPLING IS TO BE WATERTIGHT.

SHEET 1 OF 5

REV. 3/03

116.04

STORMWATER MANAGEMENT (SWM) DETAILS

VIRGINIA DEPARTMENT OF TRANSPORTATION

SPECIFICATION
REFERENCE

302

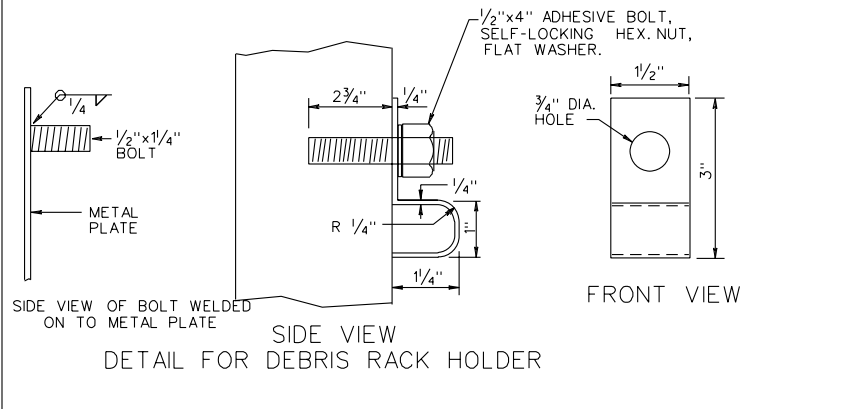

1. COST OF DEBRIS RACK, METAL PLATE, AND DEBRIS RACK HOLDER TO BE INCLUDED IN THE BID PRICE FOR THE SWM DRAINAGE STRUCTURE.
2. DEBRIS RACK MAY BE FABRICATED FROM WELDED 3/8" DIAMETER BARS OR 1/2" THICK HIGH DENSITY POLYETHYLENE. METAL COMPONENTS OF DEBRIS RACK MUST NOT BE GALVANIZED.
3. DEBRIS RACK TO BE HINGED AS SHOWN OR CONTRACTOR MAY SUBSTITUTE A COMPARABLE DESIGN AS APPROVED BY THE ENGINEER.
4. THE LOCATION OF THE DEBRIS RACK HOLDER MAY BE ADJUSTED FOR VARIABLE CONDITIONS. WHEN HOLDER BOLT IS LOCATED ON THE METAL PLATE THE 1/2" DIA. BOLT LENGTH IS TO BE REDUCED 1/4" LG. AND WELDED TO THE PLATE. DEBRIS RACK HOLDER AND ALL HARDWARE IS TO BE GALVANIZED.

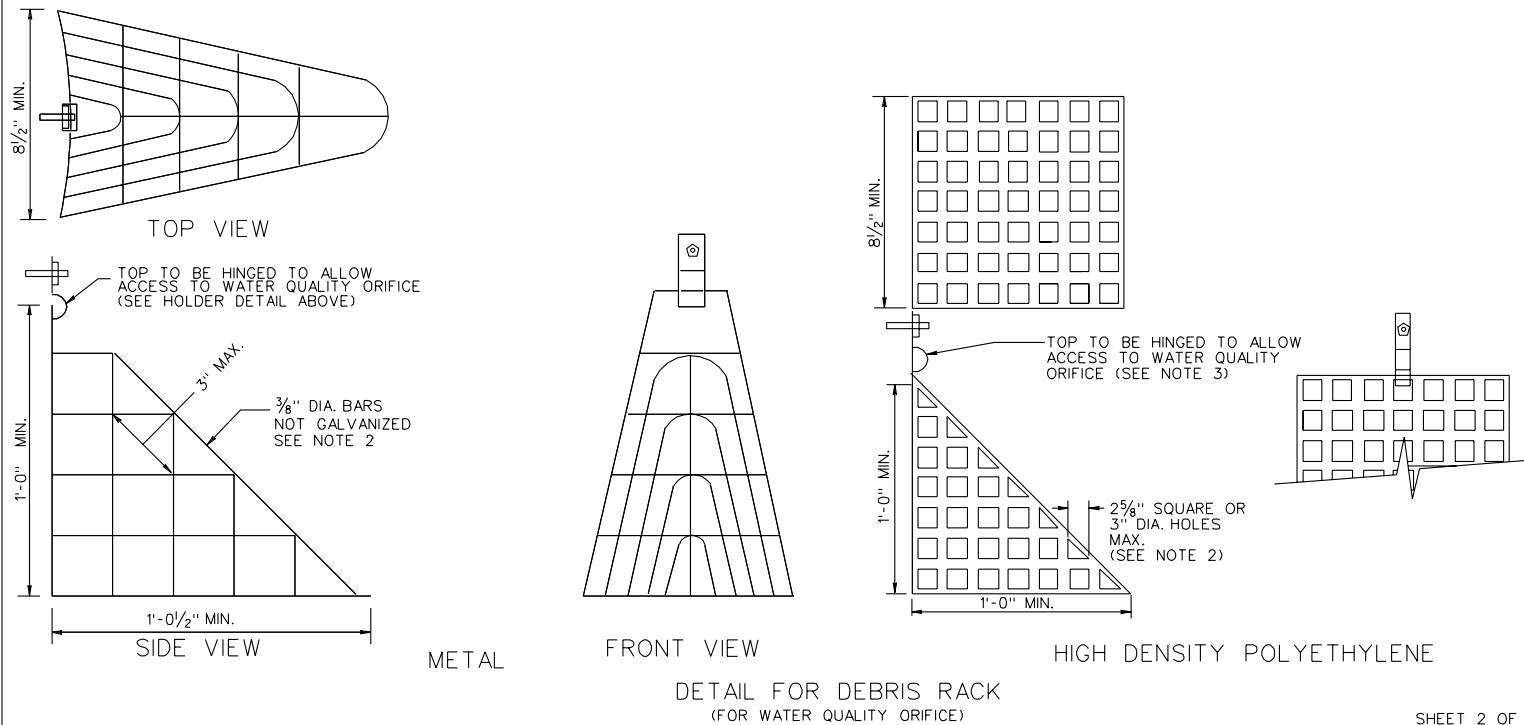

SPECIFICATION REFERENCE
302

STORMWATER MANAGEMENT (SWM) DETAILS

DEBRIS RACK, METAL PLATE, WATER QUALITY ORIFICE, CONCRETE CRADLE
(FOR SWM DRAINAGE STRUCTURES, SWM RISER PIPES AND SWM DAMS)

VIRGINIA DEPARTMENT OF TRANSPORTATION

SWM-DR

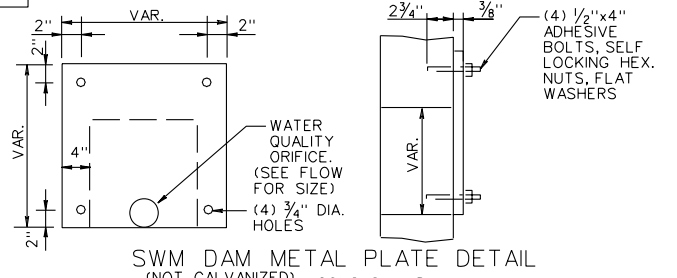

SWM DAM METAL PLATE DETAIL

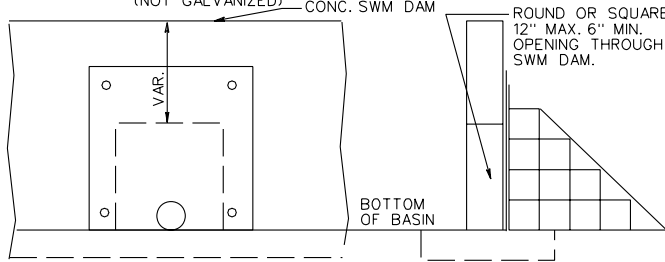

DETAIL FOR METAL PLATE AND WATER QUALITY ORIFICE
TYPICAL SWM DAM

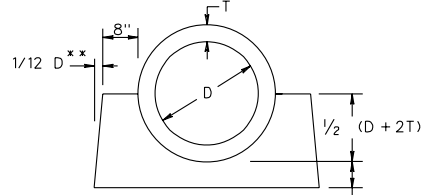

CONCRETE CRADLE

PIPE SIZE INCHES	CRADLE BOTTOM WIDTH (INCHES)	CRADLE HEIGHT (INCHES)	CRADLE TOP WIDTH (INCHES)	INCREMENT, IN CUBIC YARDS, PER LINEAR FOOT OF PIPE
12	34	14	32	0.093
15	38	15.75	35.5	0.110
18	42	17.5	39	0.129
24	50	21	46	0.168
30	58	26	53	0.233
36	66	31	60	0.307
42	74	36	67	0.390

CONCRETE SHALL BE CLASS A3
 * BUT NOT LESS THAN 6"
 ** IF THE PIPE IS LAID IN AN EXCAVATED TRENCH, THEN THE SIDE WALLS MAY CONFORM TO THE TRENCH SHAPE (IE THE TRENCH MAY BECOME THE CRADLE FORM).
 CONCRETE CRADLE IS TO BE INSTALLED UNDER THE ENTIRE LENGTH OF CULVERT AT EACH STORMWATER MANAGEMENT BASIN.
 CONCRETE CRADLE IS TO BE PAID FOR AS MISCELLANEOUS CONCRETE AND SUMMARIZED IN CUBIC YARDS FOR EACH PIPE LOCATION

METAL PLATE MUST BE CURVED TO FIT CIRCULAR UNITS WHERE APPLICABLE.

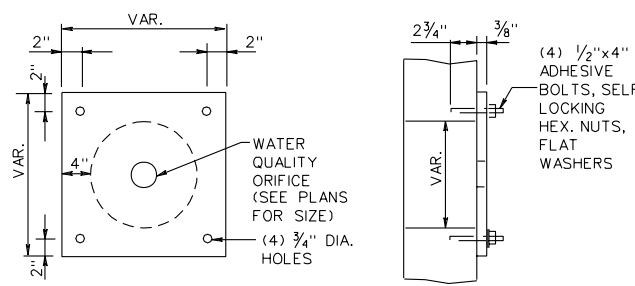

METAL PLATE DETAIL
(NOT GALVANIZED)

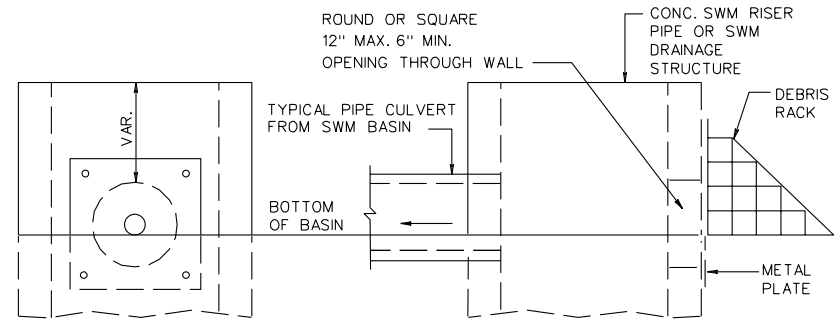

DETAIL FOR METAL PLATE AND WATER QUALITY ORIFICE
TYPICAL SWM DRAINAGE STRUCTURE

SHEET 3 OF 5

STORMWATER MANAGEMENT (SWM) DETAILS

DEBRIS RACK, METAL PLATE, WATER QUALITY ORIFICE, CONCRETE CRADLE
(FOR SWM DRAINAGE STRUCTURES, SWM RISER PIPES AND SWM DAMS)

REV. 3/03

116.06

VIRGINIA DEPARTMENT OF TRANSPORTATION

SPECIFICATION REFERENCE

302

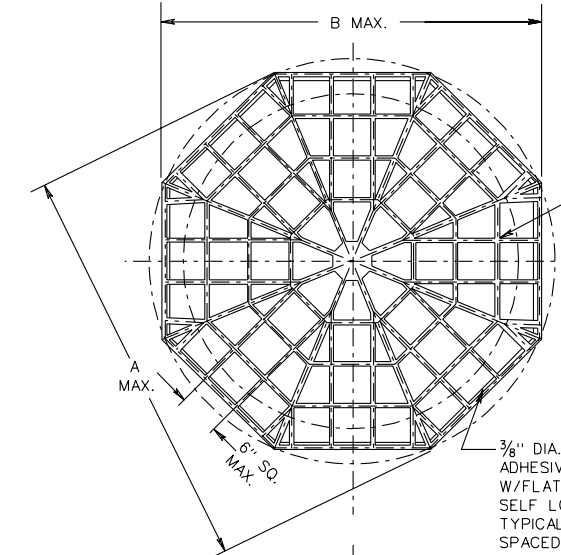

3/8" DIA. X 6" LG. ADHESIVE BOLTS W/FLAT WASHERS AND SELF LOCKING NUTS TYPICAL 8 PLACES-EQUALLY SPACED ON AN "E" DIA. B.C.

LOCKABLE ACCESS DOOR W/HINGE, MIN. 2' x 2' CLEAR OPENING SEE NOTE 1

3/8" DIA. X 6" LG. ADHESIVE BOLTS W/FLAT WASHERS AND SELF LOCKING NUTS. TYPICAL 8 PLACES-EQUALLY SPACED ON AN "E" DIA. B.C.

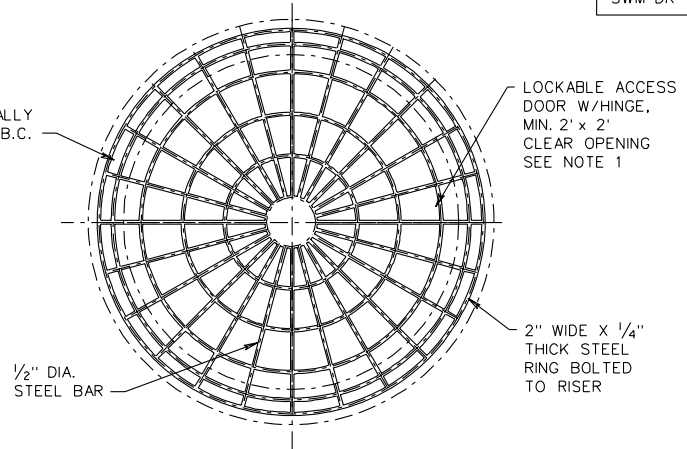

LOCKABLE ACCESS DOOR W/HINGE, MIN. 2' x 2' CLEAR OPENING SEE NOTE 1

2" WIDE X 1/4" THICK STEEL RING BOLTED TO RISER

1/2" DIA. STEEL BAR

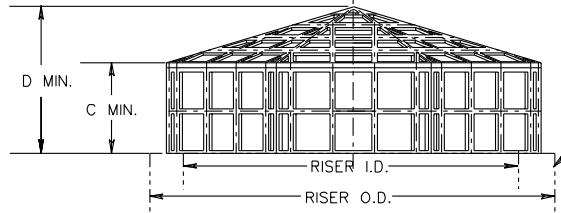

CIRCULAR STORMWATER MANAGEMENT DRAINAGE STRUCTURE

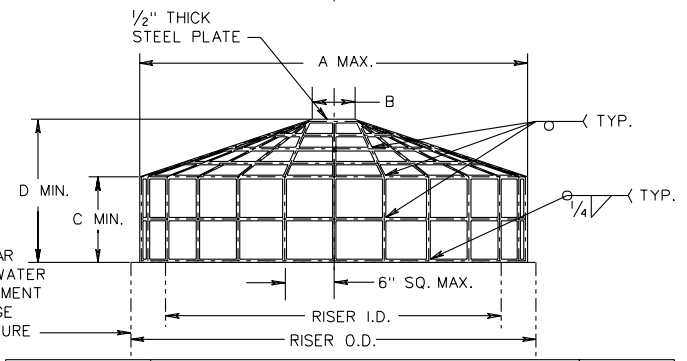

CIRCULAR STORMWATER MANAGEMENT DRAINAGE STRUCTURE

RISER		DIMENSION						APPROX. WT. (LBS.)
I.D.	O.D.	A	B	C	D	E		
24	30	31	28 5/8	7	11	27	24	
36	44	45	41 1/2	13	19	40	58	
48	58	59	54 1/2	13	21	53	86	
60	72	73	67 1/2	17	28	66	135	
72	86	87	80 3/8	23	35	79	204	
84	100	101	93 3/4	25	39	92	266	
96	114	115	106 1/4	22	38	105	305	

RISER		DIMENSION						APPROX. WT. (LBS.)
I.D.	O.D.	A	B	C	D	E	SEGMENT	
24	30	30	6	7	10	27	15	46
36	44	42	6	13	18	40	22	82
48	58	55	9	13	20	53	29	120
60	72	68	9	17	26	66	36	169
72	86	81	9	23	34	79	42	227
84	100	94	12	25	37	92	49	290
96	114	107	12	22	36	105	56	341

HIGH DENSITY POLYETHYLENE

METAL

NOTES:
 1. A HINGED, LOCKABLE ACCESS DOOR SHALL BE PROVIDED ON ALL TRASH RACKS IF THE TOTAL WEIGHT OF THE TRASH RACK IS GREATER THAN 75 LBS OR IF THE TRASH RACK IS TO BE PLACED ON A SWM-1 WITH AN "H" DIMENSION GREATER THAN 7'-2".

2. ANTI-VORTEX PLATE IS TO BE USED WHEN SPECIFIED ON THE PLANS. COST OF FURNISHING AND PLACING THE ANTI-VORTEX PLATE IS TO BE INCLUDED IN THE BID PRICE FOR THE STRUCTURE.

SPECIFICATION REFERENCE 302	<h2 style="margin: 0;">STORMWATER MANAGEMENT (SWM) DETAILS TRASH RACK FOR STORMWATER MANAGEMENT DRAINAGE STRUCTURES</h2> <p style="margin: 0;">VIRGINIA DEPARTMENT OF TRANSPORTATION</p>	NEW 3/03 116.07
------------------------------------	--	--------------------

SWM-DR

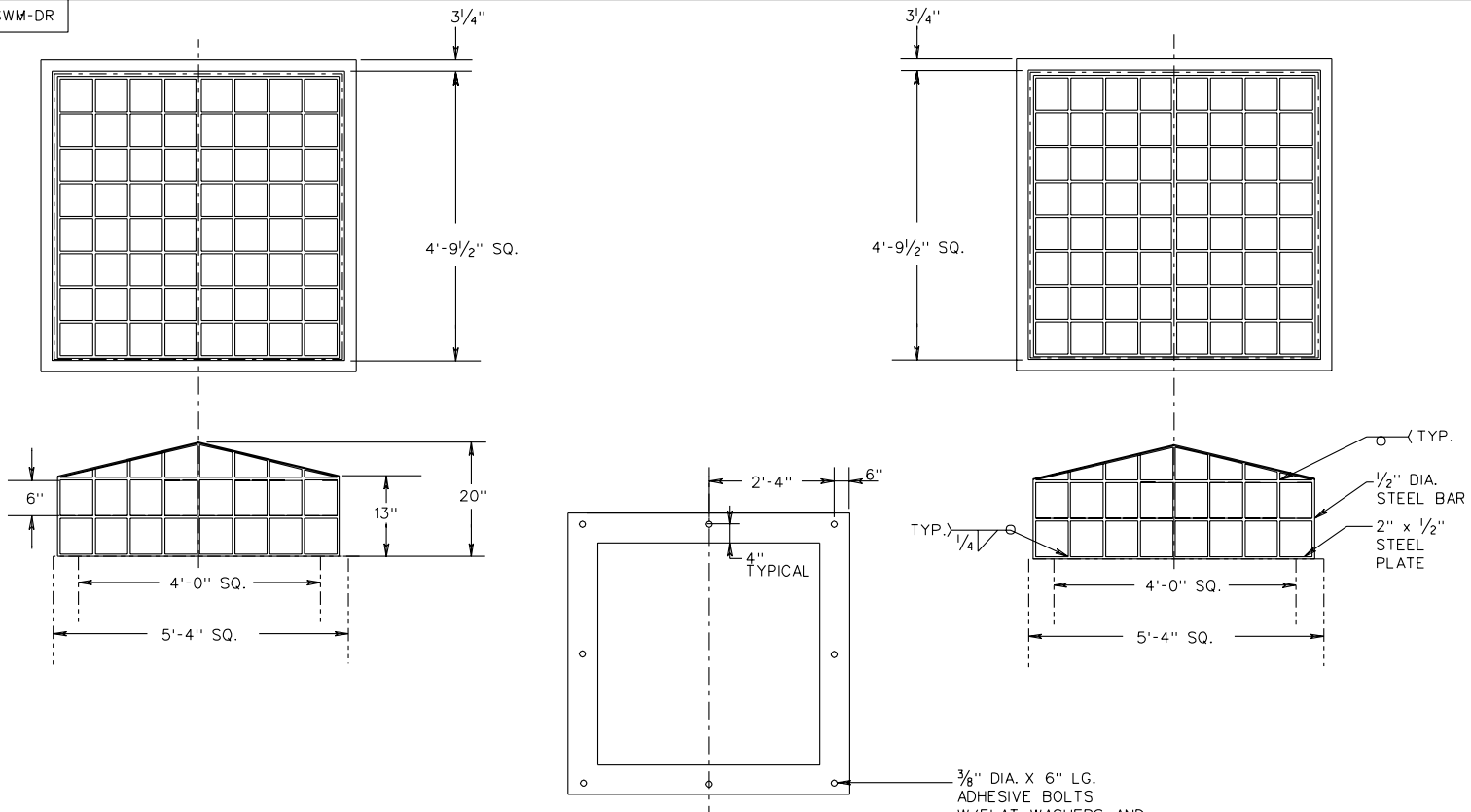

NOTES:
 1. A HINGED, LOCKABLE ACCESS DOOR WITH A MINIMUM 2' x 2' CLEAR OPENING, SHALL BE PROVIDED ON ALL TRASH RACKS.

HIGH DENSITY POLYETHYLENE

APPROX. WT. (LBS.)
95

METAL (STEEL)

APPROX. WT. (LBS.)
188

SHEET 5 OF 5

STORMWATER MANAGEMENT (SWM) DETAILS TRASH RACK FOR STORMWATER MANAGEMENT DRAINAGE STRUCTURES

NEW 3/03

116.08

VIRGINIA DEPARTMENT OF TRANSPORTATION

SPECIFICATION REFERENCE

302

STREAM DIVERSION
GENERAL NOTES

TYPICAL SECTION
TEMPORARY DIVERSION CHANNEL
AND ACCEPTABLE LININGS

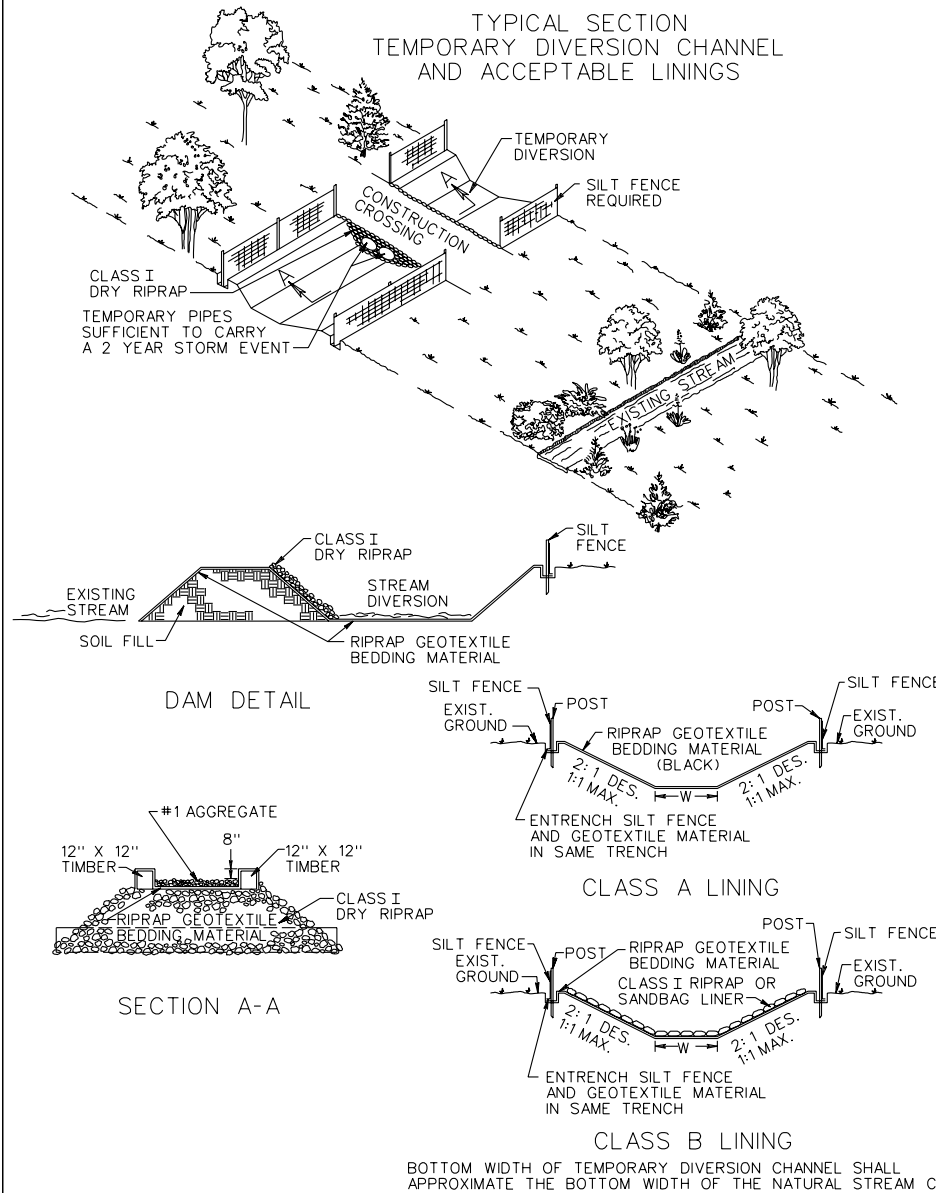

SLOPES

MAXIMUM STEEPNESS OF SIDE SLOPES SHALL BE 1:1. DEPTH AND GRADE MAY BE VARIABLE, DEPENDENT ON SITE CONDITIONS, BUT SHALL BE SUFFICIENT TO ENSURE CONTINUOUS FLOW OF WATER IN THE DIVERSION.

EXCAVATION

NO EXCAVATED MATERIAL SHALL BE STORED OR STOCKPILED NEXT TO THE DIVERSION OR IN SUCH A MANNER THAT SILTATION OF THE STREAM COULD OCCUR.

PIPE CULVERTS

PIPE CULVERT(S) MAY BE USED TO DIVERT A STREAM PROVIDED THEY ARE PROPERLY SIZED TO SAFELY CARRY THE FLOW OF A TWO YEAR STORM EVENT. UNDERSIZED PIPES SHALL BE USED FOR NO LONGER THAN 72 HOURS PROVIDED LESS THAN 50% THREAT OF RAIN CAN BE REASONABLY EXPECTED WITHIN THAT TIME PERIOD AND THEY ARE APPROVED BY THE ENGINEER.

WHEN THE CONTRACTOR USES PIPE CULVERTS IN LIEU OF THE DIVERSION CHANNEL OR A PORTION OF THE CHANNEL, PAYMENT WILL BE MADE BASED ON THE PRICE BID FOR THE QUANTITIES SHOWN ON THE PLANS FOR TEMPORARY DIVERSION CHANNEL EXCAVATION AND TEMPORARY DIVERSION CHANNEL LINING CLASS SPECIFIED.

LINING

THE CONTRACTOR SHALL HAVE THE OPTION OF USING A HIGHER CLASS OF LINING THAN THAT SPECIFIED ON THE PLANS. NO ADDITIONAL COMPENSATION WILL BE ALLOWED FOR USING THE HIGHER CLASS.

STREAM DIVERSION LINERS SHALL BE SECURED AT THE UPSTREAM AND DOWNSTREAM SIDES WITH NON-ERODIBLE WEIGHTS SUCH AS EROSION CONTROL STONE. THESE WEIGHTS SHALL ALLOW NORMAL FLOW OF THE STREAM. SOIL SHALL NOT BE MIXED IN WITH STREAM DIVERSION WEIGHTS. WEIGHTS MAY ALSO BE NEEDED ALONG THE STREAM DIVERSION'S LENGTH.

STREAM DIVERSION LINERS SHALL BE ENTRENCHED AT THE TOP OF THE DIVERSION SLOPES (SLOPE BREAKS) WITH A LINE OF SILT FENCE.

PROTECTIVE COVERING (EC-2) STAPLES OR NON-ERODIBLE WEIGHTS SHALL BE USED AS NECESSARY TO ANCHOR STREAM DIVERSION LINERS TO THE SIDE SLOPES OF THE DIVERSION. WOODEN STAKES SHALL NOT BE USED ON THE DIVERSION'S BOTTOM OR SIDE SLOPES.

STREAM DIVERSION LINERS SHALL BE OVERLAPPED WHEN A SINGLE OR CONTINUOUS LINER IS NOT AVAILABLE OR IS IMPRACTICAL. OVERLAPS SHALL BE PLACED SUCH THAT CONTINUOUS FLOW OF THE STREAM IS MAINTAINED. AN UPSTREAM SECTION SHALL OVERLAP A DOWNSTREAM SECTION BY A MINIMUM OF 18". OVERLAPS ALONG THE CROSS-SECTION SHALL BE MADE SUCH THAT A LINER IS PLACED IN THE STREAM DIVERSION BOTTOM FIRST AND ADDITIONAL PIECES OF LINER ON THE SLOPES OVERLAP THE BOTTOM PIECE BY A MINIMUM OF 18".

GENERAL

THE DOWNSTREAM PLUG SHALL BE REMOVED PRIOR TO THE UPSTREAM PLUG WHEN A STREAM DIVERSION IS USED FOR THE TRANSPORT OF WATER.

NON-ERODIBLE MATERIALS, INCLUDING BUT NOT LIMITED TO, EROSION CONTROL STONE, CONCRETE BARRIERS, SANDBAGS, PLYWOOD, OR SHEET PILING SHALL BE USED BOTH TO DIVERT THE STREAMS AWAY FROM THEIR ORIGINAL CHANNELS AND TO PREVENT OR REDUCE WATER BACKUP INTO A CONSTRUCTION AREA.

STREAMS MAY BE DIVERTED THROUGH AN EXISTING OR INCOMPLETE STRUCTURE PROVIDED THEY WILL NOT RE-ENTER A DISTURBED AREA, COME INTO CONTACT WITH WET CONCRETE, AND/OR BECOME PARTIALLY OR WHOLLY IMPOUNDED, SILTED, OR OTHERWISE CONTAMINATED.

STREAMS MAY BE REDIVERTED UPON COMPLETION OF THE DRAINAGE STRUCTURE(S) FOR WHICH THE DIVERSION WAS BUILT. PRIOR TO REDIVERSION, ANY MATERIALS USED TO PREVENT WATER BACKUP INTO THE DOWNSTREAM END OF THE DRAINAGE STRUCTURE(S) SHALL BE REMOVED. THIS MATERIAL SHALL NOT BE PLACED IN THE DOWNSTREAM END OF THE DIVERSION UNTIL AFTER WATER HAS BEEN REDIVERTED TO THE DRAINAGE STRUCTURE(S). A STREAM SHALL BE REDIVERTED BY REMOVING ALL OF THE MATERIALS DAMMING THE UPSTREAM END OF THE DRAINAGE STRUCTURE(S) BEFORE PLACING IT IN THE UPSTREAM END OF THE STREAM DIVERSION. THE DIVERSION SHALL BE SEALED OFF AT THE DOWNSTREAM END AND THEN BACKFILLED.

ONCE STARTED ANY WORK TO RELOCATE A STREAM (PLUGS) SHALL NOT BE DISCONTINUED UNTIL IT IS COMPLETED.

ANY DEVIATIONS TO THE ABOVE NOTED STREAM DIVERSION DESIGN, INSTALLATION, OR MAINTAINANCE SHALL BE APPROVED BY THE ENGINEER.

BOTTOM WIDTH OF TEMPORARY DIVERSION CHANNEL SHALL APPROXIMATE THE BOTTOM WIDTH OF THE NATURAL STREAM CHANNEL.

SPECIFICATION REFERENCE

302
303
414

TEMPORARY DIVERSION CHANNEL & ACCEPTABLE LININGS

SUGGESTED METHOD OF TEMPORARILY PLACING RIPRAP FOR EROSION CONTROL IN CHANNELS, DITCHES, & AT TOE OF FILL SLOPES

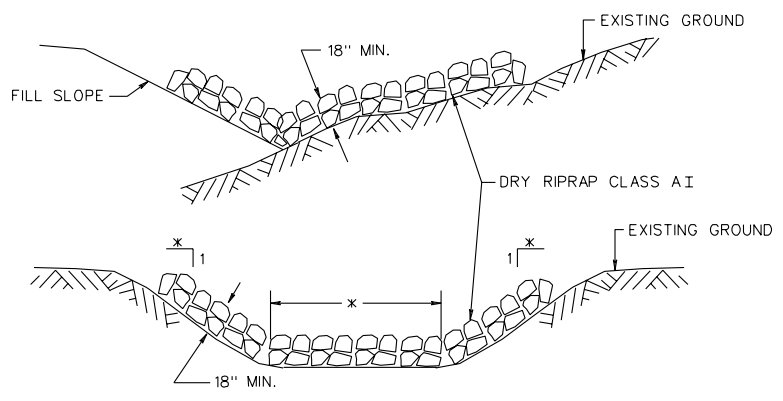

NOTES:

- 1. THE DEPTH OF PROTECTION WILL DEPEND ON WHATEVER DEPTH IS ATTAINABLE, WITH THE RIPRAP BEING EVENLY SPREAD WITH THE QUANTITY SHOWN ON THESE PLANS. RIPRAP MAY BE ADDED OR DELETED AS FOUND NECESSARY BY THE ENGINEER.
- * SIDE SLOPES AND BOTTOM WIDTH (IF TRAPEZOIDAL) SHOWN IN TYPICAL SECTION OF PROPOSED DITCH OR CHANNEL.

MINIMUM REQUIREMENTS FOR STABILIZED CONSTRUCTION ENTRANCE

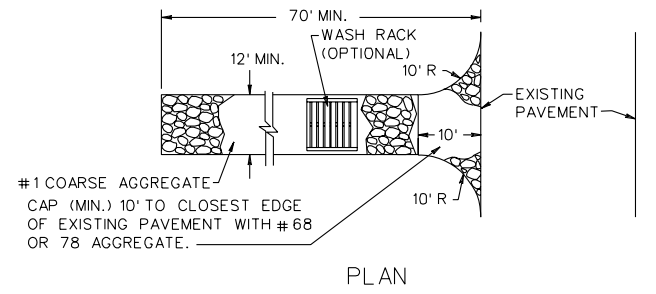

PLAN

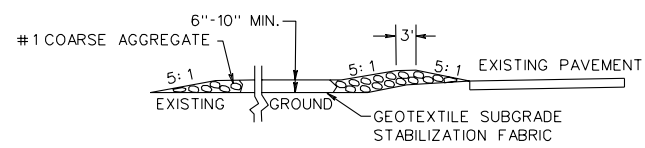

PROFILE

- 1. SURFACE WATER SHALL BE PIPED UNDER THE CONSTRUCTION ENTRANCE. IF PIPING IS IMPRACTICAL, A MOUNTABLE BERM WITH 5:1 SLOPES WILL BE PERMITTED.
- 2. THE ENTRANCE SHALL BE MAINTAINED IN A CONDITION WHICH WILL PREVENT TRACKING OR FLOWING OF SEDIMENT ONTO PUBLIC RIGHT OF WAY. THIS MAY REQUIRE PERIODIC TOP DRESSING WITH ADDITIONAL STONE AS CONDITIONS DEMAND AND REPAIR AND/OR CLEANOUT OF ANY MEASURES USED TO TRAP SEDIMENT. ALL SEDIMENT SPILLED, DROPPED, WASHED OR TRACKED ONTO PUBLIC RIGHT OF WAY SHALL BE REMOVED IMMEDIATELY.
- 3. WHEELS SHALL BE CLEANED TO REMOVE SEDIMENT PRIOR TO ENTRANCE ONTO PUBLIC RIGHT OF WAY. WHEN WASHING IS REQUIRED, IT SHALL BE DONE ON AN AREA STABILIZED WITH STONE AND WHICH DRAINS INTO AN APPROVED SEDIMENT TRAPPING DEVICE.
- 4. PERIODIC INSPECTION AND NEEDED MAINTENANCE SHALL BE PROVIDED AFTER HEAVY USE AND EACH RAIN.

SPECIFICATION REFERENCE
107 303

TEMPORARY EROSION & SILTATION CONTROL

TEMPORARY BERM & SLOPE DRAIN

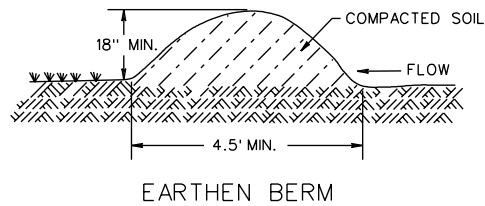
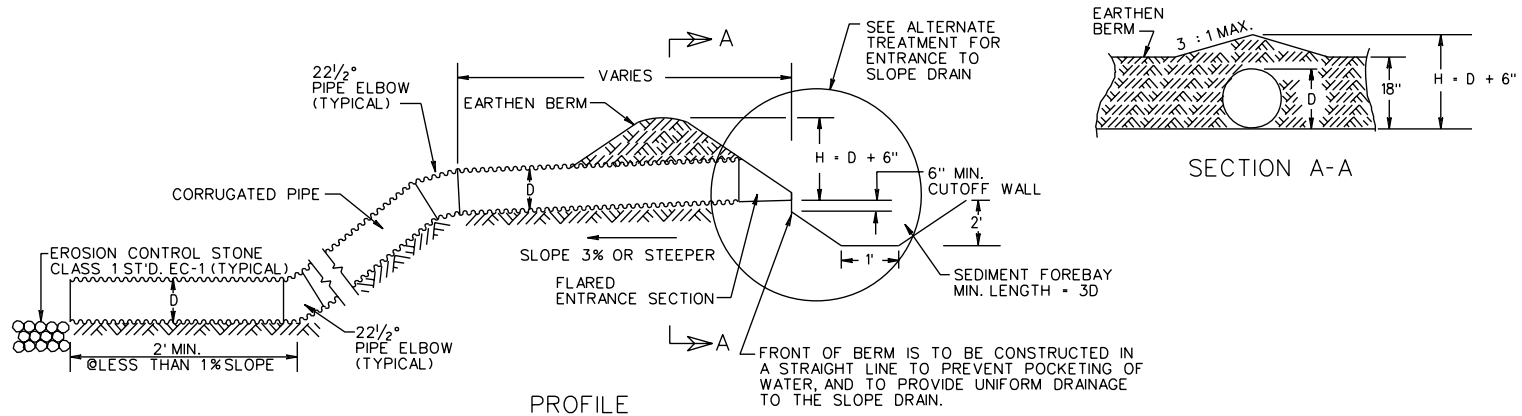

SIZE OF SLOPE DRAIN	
MAXIMUM DRAINAGE AREA (ACRES)	MINIMUM PIPE DIAMETER, D (IN.)
0.5	12
1.5	18
2.5	21
3.0	24

NOTES

1. SLOPE DRAIN SHALL BE SECURELY STAKED TO THE SLOPE, AT 10' (OR LESS) INTERVALS.
2. THE SLOPE DRAIN SECTIONS SHALL BE SECURELY FASTENED TOGETHER AND HAVE WATER TIGHT FITTINGS.

ALTERNATE ENTRANCE TREATMENT

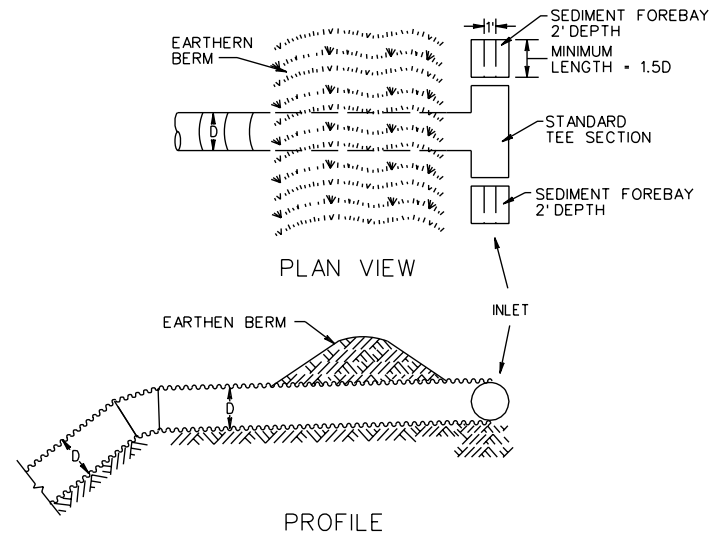

SILT BARRIERS
 TYPICAL DETAIL FOR BRUSH BARRIER
 (TO BE USED AT ALL APPLICABLE LOCATIONS)

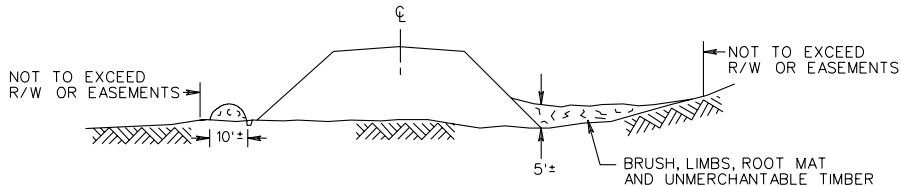
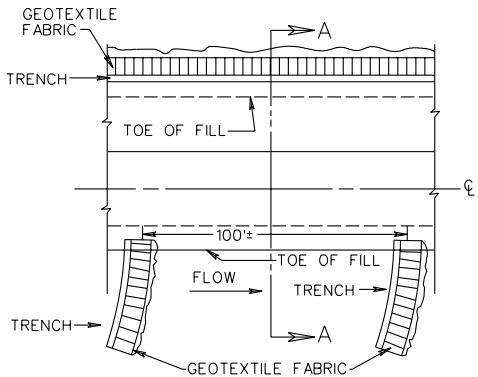

SECTION A-A

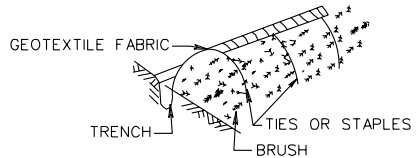

BACK ISOMETRIC

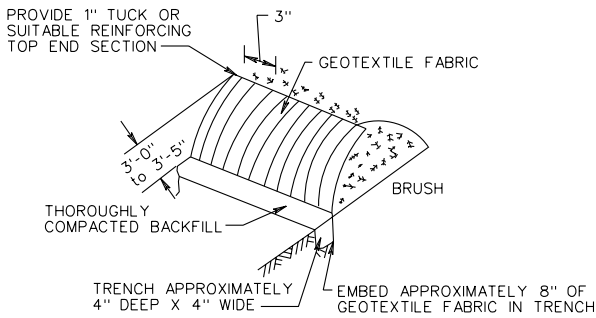

FRONT ISOMETRIC

NOTES:

1. BRUSH BARRIERS SHALL BE CONSTRUCTED AT LOCATION SHOWN ON THE PLANS OR AS DIRECTED BY THE ENGINEER. BRUSH SHALL BE PILED AGAINST EXISTING TREES TO PREVENT MOVEMENT OF BARRIER. BRUSH SHALL BE PILED AS TIGHTLY AS POSSIBLE AND WEIGHTED DOWN BY UNMERCHANTABLE LOGS.
2. GEOTEXTILE FABRIC CONFORMING TO THE ROAD AND BRIDGE SPECIFICATIONS SHALL BE INSTALLED AS DETAILED ABOVE. GEOTEXTILE FABRIC MAY ALSO BE ATTACHED TO EXISTING FENCES WHEN SPECIFIED ON THE PLANS OR DIRECTED BY THE ENGINEER.
3. NO BRUSH WILL BE DESTROYED OR REMOVED FROM THE PROJECT UNTIL ALL BRUSH SILT BARRIERS ARE IN PLACE AND HAVE BEEN INSPECTED AND APPROVED BY THE ENGINEER.
4. DIMENSIONS SHOWN ARE APPROXIMATE ONLY.

SPECIFICATION REFERENCE
107 303

TEMPORARY EROSION & SILTATION CONTROL

VIRGINIA DEPARTMENT OF TRANSPORTATION

SURVEYED BY _____
 SUPERVISED BY _____
 DESIGNED BY _____

ROADSIDE DEVELOPMENT

DESIGN FEATURES RELATING TO CONSTRUCTION OR TO REGULATION AND CONTROL OF TRAFFIC MAY BE SUBJECT TO CHANGE AS DEEMED NECESSARY BY THE DEPARTMENT

FEDERAL AID	STATE PROJECT	ROUTE	STATE PROJECT	SHEET NO.

CORE MIX

MIX	LBS./ACRES	DESCRIPTION
1	▲	* 100% CERTIFIED FINE FESCUE
2	▲	100% CERTIFIED TALL FESCUE
3	▲	50% CERTIFIED TALL FESCUE * 50% CERTIFIED FINE FESCUE
4	▲	50% ORCHARDGRASS 50% CERTIFIED KENTUCKY BLUEGRASS
5	▲	100% BERMUDAGRASS
TEMPORARY		
3/1 - 5/16 and	50	50% CERTIFIED TALL FESCUE
8/16 - 3/1	50	50% BARLEY, WINTER RYE OR WINTER WHEAT
5/16 - 8/16	50	50% FOXTAL MILLET
	50	50% CERTIFIED TALL FESCUE

ADDITIVES

TYPE	LBS./ACRES	DESCRIPTION
A	▲	100% LOVEGRASS
B	▲	100% BARLEY, WINTER RYE OR WINTER WHEAT
C	▲	100% FOXTAL MILLET
D	▲	100% ANNUAL RYEGRASS
E	▲	100% CROWNVELTCH (LEGUME)
F	▲	100% SERICEA LESPEDEZA (LEGUME)
G	▲	100% BIRDSFOOT TREFLOIL (LEGUME)
H	▲	
I	▲	
J	▲	
K	▲	

▲ ALL RATES TO BE SPECIFIED BY THE DISTRICT ROADSIDE MANAGER

* FINE FESCUES INCLUDE CHEWINGS, CREEPING RED, HARD, SHEEP

SECTION OF SEED LOCATIONS



SEEDING SCHEDULE

PROJECT NUMBERS	SLOPES SEED MIX WITH ADDITIVE	MOWED SEED MIX WITH ADDITIVE	SLOPES SEED MIX WITH ADDITIVE	MOWED SEED MIX WITH ADDITIVE	SLOPES SEED MIX WITH ADDITIVE	MOWED SEED MIX WITH ADDITIVE
	SPRING MONTH & DATE	4/1 - 6/1	SUMMER MONTH & DATE	6/1 - 9/15	FALL & WINTER MONTH & DATE	9/15 - 4/1
* SPECIFY KIND OF FINE FESCUE						

ROADSIDE DEVELOPMENT SUMMARY								
PROJECT NUMBERS	⊗ TOPSOIL 2" CLASS A B	REGULAR SEED	OVER SEEDING	LIME	FERT. 15-30-15	LEGUME SEED	LEGUME OVER SEEDING	TEMPORARY SEEDING
	ACRES	LBS.	LBS.	TONS	TONS	LBS.	LBS.	LBS.

⊗ DENOTES ITEM(S) TO BE PAID FOR ON BASIS OF PLAN QUANTITIES IN ACCORDANCE WITH CURRENT ROAD AND BRIDGE SPECIFICATIONS.

NOTES:

APPROXIMATELY _____ ACRES WILL BE DISTURBED ON THIS PROJECT AND WILL REQUIRE THE ESTABLISHMENT OF GRASSES AND/OR LEGUMES.

⚡ NOTES FOR FIELD USE ONLY

OVERSEEDING RATES SHALL BE 100 PERCENT OF THE SEED MIXTURE SUPPLIED WITHOUT FERTILIZER.

THE ENGINEER WILL REQUIRE THE CONTRACTOR TO PERFORM SUPPLEMENTAL SEEDING WHEN LESS THAN 75 PERCENT UNIFORM STAND OF THE PERMANENT GRASS SPECIFIED IN THE MIXTURES IS OBTAINED. (ANNUAL SPECIES SUCH AS RYE AND MILLET ARE TEMPORARY VARIETIES AND REQUIRE SUPPLEMENTAL SEEDING.)

NOTES APPLY TO SCHEDULE

LEGUME SEED MIXES (BIRDSFOOT TREFLOIL, CROWNVELTCH, AND SERICEA LESPEDEZA) AND WEEPING LOVEGRASS SHALL NOT BE USED ON SHOULDERS AND OTHER LOCATIONS FLATTER THAN 3:1 SLOPE.

LEGUME SEED SHALL BE INOCULATED WITH THE APPROPRIATE STRAIN AND RATE OF BACTERIA. FOR HYDROSEEDING, USE FIVE TIMES THE DRY SEEDING RATE OF INOCULATE.

A TEMPORARY MIX OR EROSION CONTROL MULCH, AS DIRECTED BY THE ENGINEER, IS TO BE USED ONLY ON AREAS THAT ARE TO BE REGRADED OR LATER DISTURBED, IF LEFT DORMANT FOR MORE THAN 15 DAYS.

EROSION CONTROL MULCH, AS DIRECTED BY THE ENGINEER, IS TO BE USED ON AREAS THAT ARE TO BE LEFT DORMANT FOR MORE THAN 15 DAYS BETWEEN DECEMBER 1 AND FEBRUARY 28.

EROSION CONTROL MULCH, AS LISTED ON THE VDOT APPROVED PRODUCTS LIST, SHALL BE APPLIED IN ACCORDANCE WITH THE MANUFACTURER'S RECOMMENDATIONS.

EROSION CONTROL MULCH SHALL PROVIDE 100 PERCENT COVERAGE OF ALL DENUDED AREAS

SPRING & SUMMER AND FALL & WINTER DEFINED FOR THE PURPOSE OF DETERMINING WHETHER HULLED OR UNHULLED BERMUDAGRASS AND SERICEA LESPEDEZA SEED IS REQUIRED:

SPRING & SUMMER 4/1 - 9/15 - USE HULLED SEED
 FALL & WINTER 9/15 - 4/1 - USE UNHULLED SEED

TYPE I MULCH (STRAW) TO BE USED ON NEWLY SEEDED AREAS ADJACENT TO ALL WATERWAYS, WETLANDS, SWAMPS, OR ANY AREA IN WHICH DRAINAGE FLOWS TOWARD AREAS UNDER THE JURISDICTION OF THE ENVIRONMENTAL REGULATORY AGENCIES.

TYPE I MULCH SHALL BE APPLIED TO PROVIDE A MINIMUM 90 PERCENT COVERAGE.

TYPE I MULCH SHALL BE TACKED WITH FIBER MULCH AT THE RATE OF 750 LBS. PER ACRE AND/OR MULCH TACKIFIER.

TYPE II MULCH (FIBER MULCH) MAY BE SUBSTITUTED FOR TYPE I MULCH AT THE RECOMMENDATION OF THE DISTRICT ROADSIDE MANAGER.

TYPE II MULCH SHALL BE APPLIED AT A RATE OF 1500 LBS. (NET DRY WEIGHT) PER ACRE TO PROVIDE A MINIMUM OF 90 PERCENT COVERAGE, AND SHALL BE APPLIED IN A SEPARATE APPLICATION.

ALL TOPSOIL IS TO BE FREE OF HARD LUMPS, CLODS, ROCKS AND FOREIGN DEBRIS AND IS TO BE HAND RAKED TO TIE INTO EXISTING LAWNS.

ALL SEED MUST BE IN CONFORMANCE WITH VDOT SEED SPECIFICATIONS FOR GRASSES & LEGUMES AND BE PROVIDED AT THE PROJECT SITE IN BAGS NOT OPENED AND LABELED FOR USE ON VDOT PROJECTS WITH A GREEN TAG CERTIFYING INSPECTION BY THE VIRGINIA CROP IMPROVEMENT ASSOCIATION.

MIX REQUIREMENTS THIS PROJECT

RECOMMENDATIONS FOR THE APPLICATION OF SEED MIXTURES (CORE MIX AND ADDITIVES), FERTILIZER, LIME, ETC. ARE TO BE OBTAINED FROM THE DISTRICT ROADSIDE MANAGER.

REVISED 7/03
 SPECIAL DESIGN SECTION
 DRAWING NO. A-4

DATE	PROJECT	ROUTE	SHEET NO.
------	---------	-------	-----------

DESIGN FEATURES RELATING TO CONSTRUCTION OR TO REGULATION AND CONTROL OF TRAFFIC MAY BE SUBJECT TO CHANGE AS DEEMED NECESSARY BY THE DEPARTMENT

DIVISION	FUND SOURCE	STATE	FEDERAL AID PROJECT	ROUTE	STATE PROJECT	MILE
	1	VA				

DETAIL NO. 1

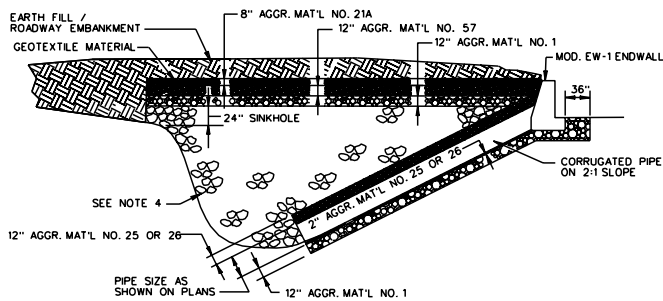

REMOVE ALL FOREIGN MATTER INCLUDING TRASH, REFUSE OR OTHER WASTE MATERIALS. EXCAVATE THE BOTTOM OF THE SINK TO ROCK, EXCAVATE THE SIDES (BACK, AHEAD, AND TOWARD TOE OF FILL SLOPE) TO AN ANGLE OF REPOSE OF 27° (2:1 SLOPE) FROM THE BOTTOM PLANE OF THE SINK. INSTALL A PIPE OF SUFFICIENT LENGTH TO INSURE POSITIVE DRAINAGE INTO THE SINK AT THE TOE OF FILL SLOPE. BED THE PIPE WITH 12" OF AGGREGATE MATERIAL NO. 1 OVERLAPPED BY 2" OF AGGREGATE MATERIAL NO. 25 OR 26 FOR A LEVELING COURSE. PLACE 12" AGGREGATE MATERIAL NO. 25 OR 26 ALONG THE SIDES AND TOP OF THE PIPE FOR PROTECTION AGAINST THE BACKFILL. BACKFILL WITH DRY RIP RAP CLASS #1 TO A HEIGHT OF 24" ABOVE ORIGINAL GROUND AS SHOWN. CAP WITH 12" AGGREGATE MATERIAL NO. 1, 12" AGGREGATE NO. 57 AND 8" AGGREGATE MATERIAL NO. 21A. OVERLAY AGGREGATE MATERIAL WITH GEOTEXTILE MATERIAL AND BACKFILL WITH EARTH FILL AS NEEDED.

DETAIL NO. 2

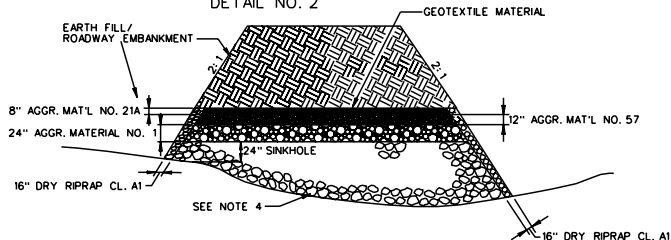

REMOVE ALL FOREIGN MATTER INCLUDING ALL VEGETATION, TRASH, REFUSE OR OTHER WASTE MATERIALS. EXCAVATE ALL UNSTABLE SOILS FROM THE SIDES AND BOTTOM OF THE SINK. BACKFILL WITH DRY RIP RAP CLASS #1 TO A HEIGHT OF 24" ABOVE THE SURFACE DRAINAGE LINE. CAP WITH 24" AGGREGATE MATERIAL NO. 1, 12" AGGREGATE MATERIAL NO. 57 AND 8" AGGREGATE MATERIAL NO. 21A. A HEAVY VIBRATOR SHALL BE USED TO STABILIZE THE RIP RAP AND THE AGGREGATE MATERIAL AS EACH COURSE IS PLACED. PLACE A LAYER OF GEOTEXTILE MATERIAL ABOVE THE AGGREGATE MATERIAL COURSES. EARTH FILL IS BE PLACED ABOVE THE GEOTEXTILE FABRIC AS NEEDED. OVERLAY EXPOSED RIP RAP/AGGREGATE FILL SLOPES WITH 16" DRY RIP RAP CLASS A1.

DETAIL NO. 3

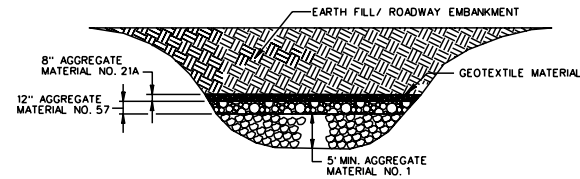

TREATMENT SHALL INCLUDE CLEARING AND GRUBBING, STRIPPING TOPSOIL AND REMOVING EXCESS ORGANIC MATERIAL, ALL FOREIGN MATTER INCLUDING TRASH, WHITE GOODS AND OTHER REFUSE OR WASTE MATERIALS SHALL BE REMOVED. STRIPPED SINKHOLE SHALL BE BACKFILLED WITH A MINIMUM OF 5' DEPTH OF NO. 1 AGGREGATE OVERLAD WITH 12" OF NO. 57 AGGREGATE AND 8" OF AGGREGATE MATERIAL NO. 21A. THE AGGREGATE SHALL BE OVERLAD WITH A GEOTEXTILE MATERIAL.

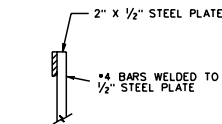

SECTION A-A

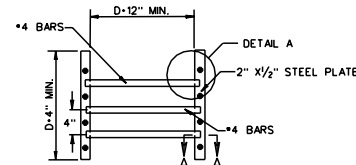

GRATE ASSEMBLY AS SHOWN SHALL BE GALVANIZED AFTER FABRICATION.

SPECIAL DESIGN GRATE DETAIL

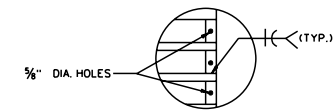

DETAIL A

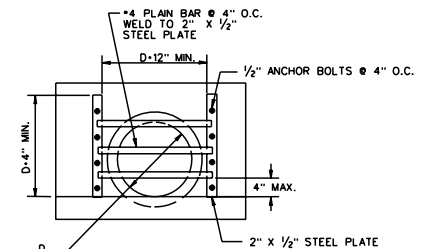

ATTACHMENT TO STANDARD EW-1

FOR USE ON STANDARD EW-1

GENERAL NOTES:

1. PRIOR TO ANY SINKHOLE EXCAVATION THE CONTRACTOR SHALL CONTACT THE DISTRICT MATERIALS ENGINEER.
2. EACH SINKHOLE SHOULD BE TREATED ON AN INDIVIDUAL, SITE SPECIFIC BASIS DEPENDING ON THE CONDITIONS IN THE AREA.
3. CONSECUTIVE LAYERS OF AGGREGATE SHALL BE PLACED IN SUCH A MANNER AS TO PREVENT FUTURE MIGRATION OF SMALLER STONES INTO LARGER STONES.
4. WHEN THE DEPTH OF A SINKHOLE OR A DEPRESSION IS LESS THAN 10', AGGREGATE MATERIAL NO. 1 SHALL BE USED FOR BACKFILL IN LIEU OF DRY RIP-RAP. THE AGGREGATE MATERIAL NO. 1 SHALL EXTEND TO A HEIGHT OF 24" ABOVE THE SURFACE DRAINAGE LINE. THE AGGREGATE MATERIAL NO. 1 SHALL BE CAPPED WITH NO. 57 AGGREGATE, NO. 21A AGGREGATE, AND GEOTEXTILE MATERIAL AS NOTED ON THE APPLICABLE DETAIL.
5. EXCAVATION NECESSARY FOR PLACEMENT OF THE SINKHOLE FILL SHALL BE MEASURED AND PAID FOR AS REGULAR EXCAVATION IN ACCORDANCE WITH THE SECTION 303 OF THE SPECIFICATIONS. ALL OTHER MATERIAL SHALL CONFORM TO AND BE MEASURED AND PAID FOR IN ACCORDANCE WITH THE APPLICABLE SECTIONS.
6. GEOTEXTILE MATERIAL SHALL CONFORM TO SECTION 245.03(B) OF THE SPECIFICATIONS
7. BASIS OF PAYMENT FOR SPECIAL DESIGN GRATE WILL BE MEASURED AND PAID FOR AT THE CONTRACT UNIT PRICE PER EACH. THIS PRICE SHALL INCLUDE ALL COST FOR FURNISHING THE FABRICATED GRATE AND ITS INSTALLATION. ALL HARDWARE, EQUIPMENT, LABOR, TOOLS, GALVANIZING AND INCIDENTALS NECESSARY TO COMPLETE THE WORK SHALL BE INCLUDED IN THE UNIT PRICE PER EACH COST.

SINKHOLE TREATMENT DETAILS

NEW 11/02
SPECIAL DESIGN SECTION
DRAWING NO. 2944