

APPENDIX F

Access Management Design Standards for Entrances and Intersections

PREFACE

The access management regulations and standards do not apply in cities, towns of more than 3,500 and in counties (Henrico and Arlington) that maintain their secondary roads (they do apply on primary routes in these two counties). Such localities, though, may choose to apply them to roads they maintain.

The 2007 General Assembly unanimously approved legislation ([Chapter 863](#)) proposed by the Governor to direct VDOT's commissioner to develop, solicit public input on, and publish access management regulations and standards by December 31, 2007 to become effective July 1, 2008. The legislative goals for access management are to:

- Reduce traffic congestion,
- Enhance public safety by decreasing traffic crash rates,
- Support economic development by promoting the efficient movement of people and goods,
- Reduce the need for new highways and road widening by maximizing the performance of the existing state highways, and
- Preserve the public investment in new highways.

To assure that a wide variety of viewpoints were considered, multiple techniques were used to gain public input on the draft regulations and standards. The commissioner approved and published the regulations and standards in December 2007.

The access management* regulations and standards were implemented in phases. The first phase applied to VDOT highways classified as principal arterials taking effect July 1, 2008 and second phase applies to minor arterials, collectors and local streets which became effective October 14, 2009.

For regulatory efficiency and streamlining on December 5, 2013 the two sets of access management regulations were consolidated into one: the Access Management Regulations 24VAC30-73, applying to all highways.

This Appendix, therefore, contains the standards for the design of intersections, turning lanes, and entrances and for the spacing of entrances, intersections, traffic signals, median crossovers that apply to all state highways: principal arterials, minor arterials, collectors, and local streets. If a design standard cannot be met a design exception or waiver is required. If a spacing standard cannot be met, a spacing exception is required. For more information, see "Exceptions to the Spacing Standards" and "Exceptions/Waivers to the Design Standards" in Section 2.

NOTE:

1. Maps of state highways by functional classification and information on the access management program are on the VDOT web site.
2. The standards do not apply to proposed VDOT minor arterials, collectors and local streets if the construction design plans were presented at a VDOT public hearing prior to October 14, 2009 or principal arterials prior to July 1, 2008.

* Rev. 1/14

Table of Contents

DEFINITIONS	F-1
SECTION 1- INTRODUCTION	
Access Management Concepts	F-7
Functional Classification.....	F-8
Functional Classification of State Highways.....	F-8
Access Control Policy (Full and Partial)	F-10
SECTION 2 – INTERSECTION DESIGN; SPACING STANDARDS	
Intersection Design Objectives	F-14
Intersection Design Principles.....	F-15
Minimum Angle of Intersections.....	F-21
Signalized Intersection Spacing.....	F-24
General Intersection and Entrance Spacing Criteria	F-25
Minimum Spacing Standards for Commercial Entrances, Intersections, and Median Crossovers	F-26
Spacing St'ds. for Commercial Entrances/Intersections Near Interchange Ramps	F-30
Exceptions/Waivers to the Spacing Standards/Access Management Requirements ..	F-32
Exceptions/Waivers to the Design Standards	F-32
Traffic Signals and Median Crossovers	F-33
Median Crossover Location Approval Process:	F-34
Signalized and Unsignalized Intersection Design (Corner Island Designs).....	F-37
Intersection Sight Distance	F-40
Stopping Sight Distance.....	F-42
Median Crossovers	F-45
Median Crossover Grades	F-45
Intersecting Cross Road Grades.....	F-48
Innovative Intersection and Interchange Policies	F-48
Roundabout Policy	F-48
Innovative Intersection and Interchange Policy	F-49
Accommodating Pedestrians and Bicyclists	F-51
SECTION 3 – TURNING LANES	
Turn Lane Criteria for Single and Dual Lanes	F-55
Warrants for Left Turn Storage Lanes on Four-Lane Highways	F-57
Warrants for Left Turn Storage Lanes on Two-Lane Highways.....	F-58
Taper Lengths (L) - Lane/Pavement Transitions and Merging Tapers	F-61
Double (Dual) Left-Turn Lanes	F-72
Continuous Left-Turn Lanes (Two Way in Either Direction).....	F-72
Medians	F-75
Illustration of Directional Median Crossover for Left Turns and U-Turns.....	F-77
Right Turn Lanes.....	F-78
Acceleration/Deceleration Lanes	F-82

SECTION 4 – ENTRANCE DESIGN

Entrance Design Principles	F-88
Entrance Definitions	F-88
Private and Low Volume Commercial Entrances	F-89
Commercial Entrances.....	F-91
Commercial Entrance Sight Distance	F-95
Limits of Maintenance Responsibility for Private and Commercial Entrances.....	F-96
Commercial Entrance Separation from an Intersection	F-96
Commercial Entrance Channelization Island Options	F-98
Commercial Entrance Spacing	F-99
Corner Clearance on a Minor Side Street.....	F-99
Entrance Connections on Opposite Sides of a Roadway	F-101
Entrance Consolidation (Shared Use Entrances).....	F-102
Interparcel Vehicular Connections	F-102
Frontage Roads.....	F-104
Entrances Affected by Highway Construction Projects	F-105
Commercial Entrance Design to Serve A Private Subdivision Road/Street	F-107
Commercial Entrance Designs along Highways with Shoulders	F-108
Commercial Entrance Designs along Highways with Curb and Gutter	F-109
Commercial Entrance Design along Local Streets w/ Curb & Gutter or Shoulders....	F-110
Commercial Entrance Designs along Highways with Shoulders at Intersection	F-111
Commercial Entrance Designs along Highways w/ Curb & Gutter at Intersection	F-112
Commercial Entrance Designs to Serve Drive-In Type Businesses.....	F-113
Moderate Volume Commercial Entrance Design along Highways with Shoulders	F-114
Agritourism Entrance Standards	F-115
Bibliography	F-116

LIST OF TABLES AND FIGURES

(FIGURES SHOWN ARE FOR ILLUSTRATION PURPOSES ONLY, UNLESS OTHERWISE NOTED.)

Figure 1-1 Schematic of a Functionally Classified Roadway Network	F-9
Figure 2-1 Conflict Points.....	F-15
Figure 2-2 Vehicular Circulation Between Adjoining Properties	F-18
Figure 2-3 Types of Access Channelization.....	F-19
Figure 2-4 Types of Access Channelization.....	F-20
Figure 2-5 U-Turn Design Options	F-21
Figure 2-6 Minimum Angle of Intersections.....	F-21
Figure 2-7 Access Development Scenario Along A State Highway	F-22
Figure 2-8 Illustration of Entrance and Intersection Spacing.....	F-23
Table 2-1 Relationship Between Speed, Cycle Length, & Signal Spacing.....	F-25
Table 2-2 Minimum Spacing Standards For Commercial Entrances, Intersections And Median Crossovers	F-26
Figure 2-8.1 Illustration of The Relationship Between Spacing Standards	F-29
Table 2-3 Minimum Spacing Standards For Intersections and Commercial Entrances Near Interchange Areas On Multilane Crossroads.....	F-30
Figure 2-9 Access Control On Multi Lane Highways At Interchanges.....	F-30
Table 2-4 Minimum Spacing Standards For Commercial Entrances And Intersections Near Interchange Areas On Two-Lane Crossroads	F-31
Figure 2-10 Access Control On Two Lane Highways At Interchanges.....	F-31
Figure 2-11 Intersection Design For Rural Applications With or Without Standard Si-1 Sign Island Design	F-38
Figure 2-12 Intersection Design For Rural Applications With or Without Standard Si-2 or Si-3 Sign Island Design.....	F-39
Table 2-5 Intersection Sight Distance	F-40
Figure 2-13 Median Crossovers With and Without Connections.....	F-46
Figure 2-23 Reducing The Number of Entrances Benefits Pedestrians and Bicyclists ...	F-53
Figure 3-1 Right and Left Turn Lane Criteria For Single and Dual Lanes	F-55
Figure 3-2 Left and Right Turn Storage and Taper Lengths	F-56
Figure 3-3 Warrants For Left Turn Storage Lanes On Four-Lane Highways	F-57
Table 3-1 Warrants For Left Turn Lanes On Two-Lane Highways.....	F-59
Figure 3-4 Passing/Left Turn Lane.....	F-60
Figure 3-5 Warrant For Left-Turn Storage Lanes On Two-Lane Highway	F-62
Figure 3-6 Warrant For Left-Turn Storage Lanes On Two-Lane Highway	F-62
Figure 3-7 Warrant For Left-Turn Storage Lanes On Two-Lane Highway	F-63
Figure 3-8 Warrant For Left-Turn Storage Lanes On Two-Lane Highway	F-63
Figure 3-9 Warrant For Left-Turn Storage Lanes On Two-Lane Highway	F-64
Figure 3-10 Warrant For Left-Turn Storage Lanes On Two-Lane Highway	F-64
Figure 3-11 Warrant For Left-Turn Storage Lanes On Two-Lane Highway	F-65
Figure 3-12 Warrant For Left-Turn Storage Lanes On Two-Lane Highway	F-65
Figure 3-13 Warrant For Left-Turn Storage Lanes On Two-Lane Highway.....	F-66
Figure 3-14 Warrant For Left-Turn Storage Lanes On Two-Lane Highway.....	F-66

Figure 3-15 Warrant For Left-Turn Storage Lanes On Two-Lane Highway.....	F-67
Figure 3-16 Warrant For Left-Turn Storage Lanes On Two-Lane Highway.....	F-67
Figure 3-17 Warrant For Left-Turn Storage Lanes On Two-Lane Highway.....	F-68
Figure 3-18 Warrant For Left-Turn Storage Lanes On Two-Lane Highway.....	F-68
Figure 3-19 Warrant For Left-Turn Storage Lanes On Two-Lane Highway.....	F-69
Figure 3-20 Warrant For Left-Turn Storage Lanes On Two-Lane Highway.....	F-69
Figure 3-21 Warrant For Left-Turn Storage Lanes On Two-Lane Highway.....	F-70
Figure 3-22 Warrant For Left-Turn Storage Lanes On Two-Lane Highway.....	F-70
Table 3-2 Truck Adjustments	F-71
Figure 3-23 Double Left-Turn Lanes	F-73
Figure 3-24 Continuous Two-Way Median Left-Turn Lanes	F-74
Figure 3-25 Illustration of Directional Median Crossover For Left Turns and U-Turns ..	F-77
Figure 3-26 Warrants For Right Turn Treatment (2-Lane Highway).....	F-80
Figure 3-27 Warrants For Right Turn Treatment (4-Lane Highway).....	F-81
Figure 3-28 Typical Application With Sidewalks and Bike Lanes With Right-Turn Deceleration Lanes (Curb and Gutter Section)	F-83
Figure 3-29 Typical Application of A Bus Pullout	F-84
Figure 3-30 Typical Application of A Rt. Turn Decelerati On Lane (Shoulder Section) ..	F-85
Figure 3-31 Typical Application of A Left Turn Deceleration Lane (Shoulder Section)..	F-86
Figure 3-32 Typical Application of A Right Turn Acceleration and Deceleration Lane (Shoulder Section)	F-87
Table 4-1 Entrance Types and Rules.....	F-88
Figure 4-1 Private Entrance and Low Volume Commercial Entrance Detail	F-90
Table 4-2 Summary of Entrance Throats	F-92
Figure 4-1A Entrance Throat Detail	F-92
Table 4-3 Design Vehicle And Turning Radius By Land Use	F-94
Figure 4-2 Limits of Maintenance Responsibility for Private & Commercial Entrances ..	F-96
Figure 4-2A Physical and Functional Areas of Intersection.....	F-96
Figure 4-3 Elements of The Functional Area of Intersection	F-97
Figure 4-4 Commercial Entrance Channelization Island Options.....	F-98
Figure 4-5 Corner Clearance	F-100
Figure 4-6 Entrance Connections On Opposite Sides of A Roadway	F-101
Figure 4-7 Shared Entrance And Internal Site Connection	F-103
Figure 4-8 Commercial Entrance Design To Serve A Private Subdivision Rd./St.....	F-107
Figure 4-9 Commercial Entrance Designs Along Highways With Shoulders	F-108
Figure 4-10 Commercial Entrance Designs Along Highways With Curb and Gutter ...	F-109
Figure 4-11 COMMERCIAL Entrance Designs Along Local Streets	F-110
Figure 4-12 Commercial Entrance Designs Along Highways With Shoulders At Intersection	F-111
Figure 4-13 Commercial Entrance Designs Along Highways With Curb & Gutter At Intersection	F-112
Figure 4-14 Commercial Entrance Designs To Serve Drive-In Type Businesses	F-113
Figure 4-15 Moderate Volume Commercial Entrance Design Along Highways With Shoulders.....	F-114

DEFINITIONS

Acceleration Lane: An auxiliary lane, including tapered areas, that enables a motorist to increase its speed to a rate that enables it to safely merge with through traffic.

Access Management: The systematic control of the location, spacing, design, and operation of entrances, median crossovers, traffic signals, and interchanges for the purpose of providing vehicular access to land development in a manner that preserves the safety and efficiency of the transportation system.

Agritourism Entrance: “Agritourism activity” as “any activity carried out on a farm or ranch that allows members of the general public, for recreational, entertainment, or educational purposes, to view or enjoy rural activities, including farming, wineries, ranching, historical, cultural, harvest-your-own activities, or natural activities and attractions, Code of Va. [§3.2-6400](#).”*

Arterial: A major highway intended to serve through traffic where access is carefully controlled, generally highways of regional importance, intended to serve moderate to high volumes of traffic traveling relatively long distances and at higher speeds.

Auxiliary Lane: The portion of the roadway adjoining the traveled way for speed change, turning, storage for turning, weaving, truck climbing, and other purposes supplementary to through-traffic movement.

Channelization: The separation or regulation of conflicting traffic movements into definite paths of travel by traffic islands or pavement marking to facilitate safe and orderly movements of vehicles, pedestrians and bicyclists.

Collector: The functional classification of a highway that provides land access service and traffic circulation within residential, commercial, and industrial areas. The collector system distributes trips from principal and minor arterials through the area to the ultimate destination. Conversely, collectors also collect traffic from local streets in residential neighborhoods and channel it into the arterial system.

Commercial Entrance: Any entrance serving land uses that generate more than 50 vehicular trips per day or the trip generation equivalent of more than five individual private residences or lots for individual private residences using the methodology in the Institute of Transportation Engineers Trip Generation.

Conflict: A traffic conflict occurs when the paths of vehicles intersect, an event that causes a driver to take evasive action to avoid collision with another vehicle, usually designated by a braking application or evasive lane change.

Conflict Point: An area where intersecting traffic either merges, diverges or crosses. Each conflict point is a potential collision.

Corner Clearance: The distance an entrance on a minor side street needs to be separated from the minor side street’s intersection with a major roadway. It is aimed at preventing the location of entrances within the functional area of an intersection. The major roadway will have the higher functional classification (excluding local streets), or will have the higher traffic volume.

* Rev. 7/17

Deceleration Lane: A speed-change lane including tapered areas that enables a turning vehicle to exit a through lane and slow to a safe speed to complete its turn.

Design Speed: The selected speed used to determine the geometric design features of the highway.

Design Vehicle - A design vehicle is a selected motor vehicle whose weight, dimensions and operating characteristics are used to establish highway design.*

Divided Highway: A highway on which traffic traveling in opposite directions is physically separated by a median.

Engineer: The Engineer representing the Virginia Department of Transportation.

Entrance: Any driveway, street or other means of providing for the movement of vehicles to or from the state highway system.

Entrance Throat: The distance parallel to the centerline of an entrance to the first on-site location at which a driver can make a right turn or a left turn, measured on highways with curb and gutter, from the face of the curb, and on highways without a curb and gutter, from the edge of the shoulder.

Entrance Width: The distance edge-to-edge of an entrance measured at the right-of-way line.

Egress: The exit of vehicular traffic from a property to a highway.

Exception: Permission to depart from standards because of the unique circumstances of the site or project.

Frontage Road: A road that generally runs parallel to a highway between the highway right-of-way and the front building setback line of the abutting properties and provides access to the abutting properties for the purpose of reducing the number of entrances to the highway and removing the abutting property traffic from through traffic on the highway.

Full Access Entrance: Entrance which allows left-in and left-out movements and right-in and right-out movements.

Functional Area of an Intersection: The area beyond the physical intersection that comprises decision and maneuver distance, plus any required vehicle storage length, and is protected through corner clearance standards and connection spacing standards.

Functional Classification: The federal system of classifying groups of highways according to the character of service they are intended to provide. Each highway is assigned a functional classification based on the highway's intended purpose of providing priority to through traffic movement or adjoining property access. The functional classification system groups highways into three basic categories identified as (1) arterial, with the function to provide through movement of traffic; (2) collector, with the function of supplying a combination of through movement and access to property; and (3) local, with the function of providing access to property.

* Rev. 1/18

Grade Separation: A crossing of two highways or a highway and a railroad, or a highway and a pedestrian walkway, at different elevations.

Gradient or Grade: The rate or percentage change in slope, measured along the centerline of the highway or entrance, either ascending or descending from or along the highway.

Highway, Street, or Road: A public right of way for purposes of vehicular travel, including the entire area within the right-of-way.

Ingress: The entrance of vehicular traffic into a property from a highway.

Interchange: A grade-separated system of access to and from highways that includes directional ramps for access to and from crossroads.

Intersection: An at-grade crossing of two or more highways in a “T” three leg design or four leg design, a median crossover, or full access entrances directly across from each other on an undivided highway.

Intersection Sight Distance: The sight distance required at entrances and intersections to allow the driver of a stopped vehicle a sufficient view of the intersecting highway to decide when to enter, or cross, the intersecting highway.

Legal Speed Limit: The speed limit set forth on signs lawfully posted on a highway or in the absence of such signs the speed limit established by Title 46.2, Chapter 8, Article 8 of the Code of Virginia

Limited Access Highway: A highway especially designed for through traffic over which abutters have no easement or right of light, air, or access by reason of the fact that their property abuts upon the limited access highway.

Local Streets/Roads: The functional classification for highways that comprise all facilities that are not collectors or arterials. Local streets serve primarily to provide direct access to abutting land and to other streets.

Low Volume Commercial Entrance: Any entrance, other than a private entrance, serving five or fewer individual residences or lots for individual residences on a privately owned and maintained road or land uses that generate 50 or fewer vehicular trips per day using the methodology in the Institute of Transportation Engineers Trip Generation.

Median: That portion of a divided highway that separates opposing traffic flows, not including center two-way left-turn lanes, can be traversable or non-traversable.

Median Crossover: An opening in a nontraversable median that can be designed to provide for crossing, left turns and U-turns. See “Median Crossover (Directional)” and “Median Crossover (Full)”.

Median Crossover (Directional): An opening in a restrictive median that provides for specific movements and physically restricts other movements.

Median Crossover (Full): An opening in a restrictive median that provides for crossing, left turns and U-turns.

Median, Non-traversable (Restrictive Median): A physical barrier that separates traffic traveling in opposite directions, such as a concrete barrier or landscaped island.

Median, Traversable (Nonrestrictive Median): A median that by its design does not physically discourage or prevent vehicles from entering upon or crossing over it, including painted medians.

Merge: The process by which two separate traffic streams moving in the same direction combine or unite to form a single stream.

Minor Arterial: The functional classification for highways that interconnect with and augment the principal arterial system. Minor arterials distribute traffic to smaller geographic areas providing service between and within communities.

Moderate Volume Commercial Entrance: A commercial entrance along highways with shoulders with certain site and design criteria reduced. Site requirements are: maximum highway vehicles per day: 5,000, maximum entrance vehicles per day: 200, maximum entrance percent truck trips of vehicles per day: 10%.*

Operating Speed: The speed at which drivers are observed operating their vehicles during free-flow conditions with the 85th percentile of the distribution of observed speeds being the most frequently used measure of the operating speed of a location or geometric feature.

Passing Sight Distance: The length of roadway that the driver of the passing vehicle must be able to see initially, in order to make a passing maneuver safely.

Partial Access Entrance: Entrance with movements limited to right-in or right-out or both, with or without left-in movements.

Peak Hour Volume: The largest number of vehicles passing over a designated section of a street during the busiest 60-minute period within a 24-hour period.

Phase (Signal): That portion of a traffic signal cycle allocated to a specific traffic movement or combination of movements.

Primary Highway: The system of state highways assigned route numbers under 600.

Principal Arterial: The functional classification for a major highway intended to serve through traffic where access is carefully controlled, generally highways of regional importance, with moderate to high volumes of traffic traveling relatively long distances and at higher speeds.

* Rev. 1/15

Private Subdivision Road or Street Entrance: A commercial entrance for a road or street that serves more than five individual properties and is privately owned and maintained.

Private Entrance: An entrance that serves up to two private residences and is used for the exclusive benefit of the occupants or an entrance that allows agricultural operations to obtain access to fields or an entrance to civil and communication infrastructure facilities that generate 10 or fewer trips per day such as cell towers, pump stations, and stormwater management basins.

Ramp Terminal: That portion of a ramp adjacent to the through traveled way, including speed-change lanes, tapers, and islands. Ramp terminals may be the at-grade type, as at the crossroad terminal of diamond or partial cloverleaf interchanges, or the free-flow type where ramp traffic merges with or diverges from high-speed through traffic at flat angles.

Right-of-way: That property within the systems of state highways that is open or may be opened for public travel or use or both in the Commonwealth. This definition includes those public rights-of-way in which the Commonwealth has a prescriptive easement for maintenance and public travel. The property includes the traveled way and associated boundary lines and parking and recreation areas.

Roadway: The portion of a highway, including shoulders, for vehicular use. A divided highway has two or more roadways.

Roundabout: A circular intersection with yield control of all entering traffic, right-of-way assigned to traffic within the circular roadway, and channelized approaches and a central island that deflect entering traffic to the right.

Rural Area: The areas outside the boundaries of urbanized areas and urban places (see Urban Area).*

Secondary Highway: The system of state highways assigned route numbers 600 and above.

Shared Entrance: A single entrance to provide access to two or more adjoining parcels.

Shoulder: The portion of the highway that lies between the edge of the traveled way and the break point, excluding turn lanes.

Sight Distance: The distance visible to the driver of a vehicle when the view is unobstructed by traffic.

Sight Triangle: An area of unobstructed sight distance along both approaches of an entrance.

Signal Progression: The progressive movement of traffic, at a planned rate of speed without stopping, through adjacent signalized locations within a traffic control system.

Signal Spacing: The distance between traffic signals along a highway.

* Rev, 1/12

Stopping Sight Distance: The distance required by a driver of a vehicle, traveling at a given speed, to bring the vehicle to a stop after an object on the highway becomes visible, including the distance traveled during the driver's perception and reaction times and the vehicle braking distance.

Storage Length: Lane footage added to a deceleration lane to store the maximum number of vehicles likely to accumulate during a peak period, so as not to interfere with the through-travel lanes.

Taper: The widening of pavement to allow the redirection and transition of vehicles around or into a turn lane; of two types: (a) redirect tapers necessary for the redirection of vehicles along the traveled way; and (b) transition tapers for turn lanes that allow the turning vehicle to transition from or to the traveled way, to or from a turn lane.

Through Movement: The predominant direction of traffic flow through an intersection, straight on most major roads, although the predominant flow of traffic occasionally is in a right or left-turning direction.

Traveled Way: The portion of the highway provided for the movement of vehicles, exclusive of shoulders and turn lanes.

Turn Lane: A separate lane for the purpose of enabling a vehicle that is entering or leaving a highway to increase or decrease its speed to a rate at which it can more safely merge or diverge with through traffic; acceleration and deceleration lanes.

Urban Area: An urbanized area (population of 50,000 and over), or an urban place as designated by the Bureau of the Census (population of 5,000 or more) and not within any urbanized area, with boundaries fixed by State and local officials and approved by the Federal Highway Administration.*

VPH: The number of vehicles per hour, usually referring to vehicles in a peak hour.

Warrant: The criteria by which the need for a safety treatment or highway improvement can be determined.

Weaving: The crossing of two or more traffic streams traveling in the same general direction along a significant length of highway, without the aid of traffic control devices. Weaving areas are formed when a merge area is closely followed by a diverge area, or when an entrance ramp is closely followed by an exit ramp and the two ramps are joined by an auxiliary lane.

* Rev. 1/12

SECTION 1- INTRODUCTION

Access Management Concepts

Access management provides a systematic approach to balancing the access and mobility necessities of a roadway. Access management can be defined as the process of managing access to land development, while simultaneously preserving the flow of traffic on the surrounding public road system.

Property owners have a right to reasonable access to the general system of streets and highways. In conjunction, adjacent roadway users have the right to freedom of movement, safety, and efficient expenditure of public funds. Balancing these interests is critical at locations where significant changes to the transportation system and/or surrounding land uses are occurring. The safe and efficient operation of the transportation system calls for effectively managing highway access, via entrances, streets, or other access points.

The specific techniques for managing access involve the application of established traffic engineering and planning principles. Ideally, these principles will:

- Limit the number of traffic conflicts;
- Separate basic conflict areas;
- Separate turning volumes from through movements;
- Provide sufficient spacing between at-grade intersections;
- Maintain progressive speeds along arterials;
- Provide adequate on-site storage lanes.

The application of these principles will minimize disruptions to through traffic caused by entrances and intersections. More specifically, good access management can:

- Reduce crashes and crash potential;
- Preserve roadway capacity and the useful life of roads;
- Decrease travel time and congestion;
- Improve access to properties;
- Coordinate land use and transportation decisions;
- Improve air quality;
- Maintain travel efficiency and related economic prosperity.

Functional Classification

The Federal Highway Administration's (FHWA) "Functional Classification Guidelines" state that Functional Classification is the process by which streets and highways are grouped into classes or systems, according to the character of service they are intended to provide.

Basic to this process is the recognition that individual roads and streets do not serve travel independently in any major way. Rather, most travel involves movement through a network of roads. It becomes necessary then to determine how this travel can be channelized within the network in a logical and efficient manner.

Functional classification defines the nature of this channelization process by defining the part that any particular road should play in serving the flow of trips through a highway network. Allied to the idea of traffic channelization is the dual role the highway network plays in providing (1) access to property, and (2) travel mobility. Mobility can be provided at varying levels, usually referred to as "level of service." It can incorporate a wide range of elements (e.g., riding comfort and freedom from speed changes) but the most basic is operating speed or trip travel time. The four major functional classifications are:

- Principal arterial is a major highway intended to serve through traffic where access is carefully controlled, generally highways of regional importance, with moderate to high volumes of traffic traveling relatively long distances and at higher speeds.
- Minor arterials are highways that interconnect with and augment the principal arterial system. Minor arterials distribute traffic to smaller geographic areas providing service between and within communities.
- Collector is a highway that provides land access service and traffic circulation within residential, commercial, and industrial areas. The collector system distributes trips from principal and minor arterials through the area to the ultimate destination. Conversely, collectors also collect traffic from local streets in residential neighborhoods and channel it into the arterial system.
- Local streets/roads comprise all facilities that are not collectors or arterials. Local streets serve primarily to provide direct access to abutting land and to other streets.*

Functional Classification of State Highways

Information on the process for establishing a functional classification for a new road or for changing the functional classification for an existing highway is available on the VDOT web site at [Functional Classification](#). Maps identifying the functional classification of all state highways are also presented on this web site.

* Rev. 1/12

Schematic of a Functionally Classified Roadway Network

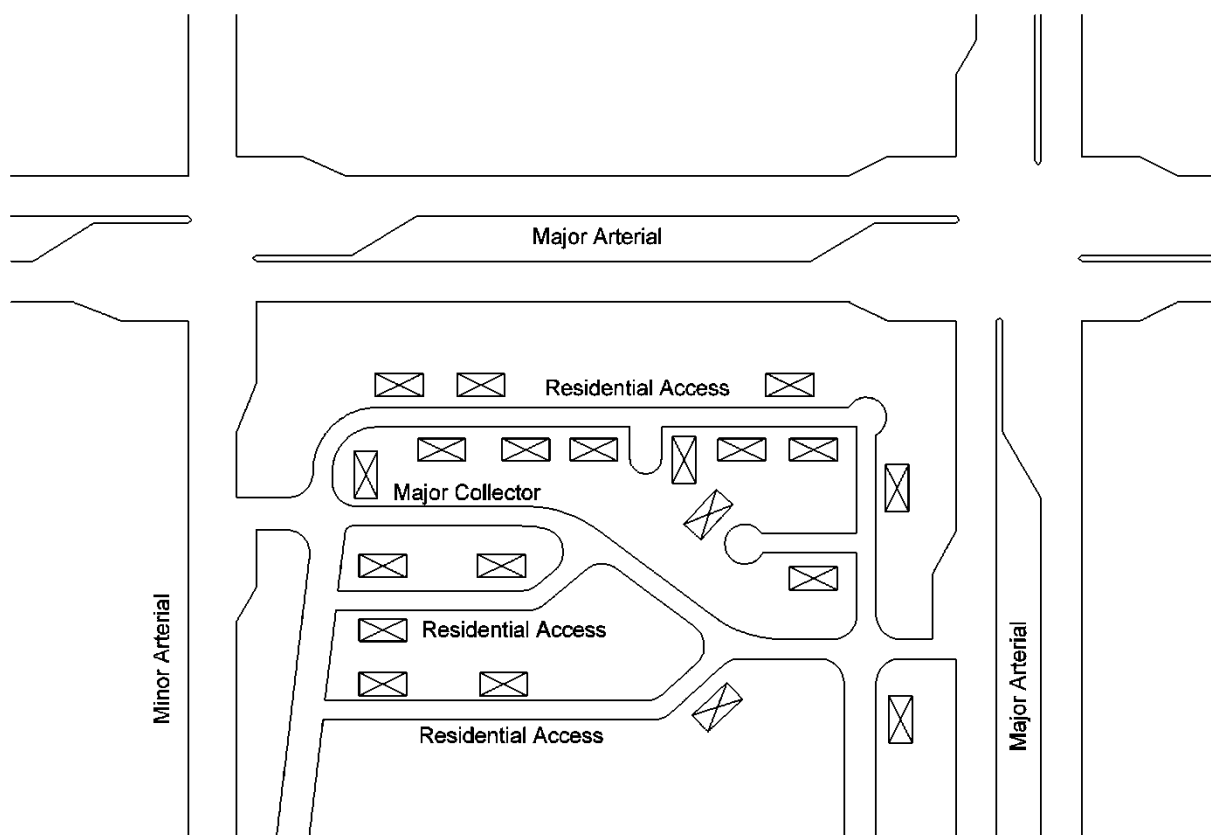

FIGURE 1-1

Source: Transportation Research Board, *Access Management Manual*, 2003

ACCESS CONTROL POLICY (FULL AND PARTIAL)*

Defined levels pertaining to access for roadways have been established and documented by the Transportation Research Board (TRB). These categories proposed by TRB have been incorporated into various DOT procedures, including VDOT's. The proposed categories are as follows:

- Level of importance of roadways within the jurisdiction
 - Characteristics of system roadways
 - Land use and growth management goals
 - Current and potential future presence of pedestrians, bicyclists and transit
 - Engineering judgment
- VDOT and LOCALITY MANAGED PROJECTS
 - On VDOT managed projects, see the current policy on Limited Access Establishment and Change Guidelines in Section 2E-5 Proposed Right of way and Limited Access at http://www.extranet.vdot.state.va.us/locdes/Electronic_Pubs/2005%20RDM/chap2e.pdf
 - On locality managed projects, the locality should consult their VDOT Project Coordinator for information on limited access. See the current policy on Limited Access Establishment and Change Guidelines in Section 2E-5 Proposed Right of way and Limited Access at http://www.extranet.vdot.state.va.us/locdes/Electronic_Pubs/2005%20RDM/chap2e.pdf
 - NHS & INTERSTATE SYSTEMS
 - Access control beyond the ramp terminals should be affected by purchasing access rights, providing frontage roads, controlling added corner right-of-way areas, or prohibiting driveways. At a minimum, such control should extend beyond the ramp terminal at least 100 ft. (30 m) in urban areas and 300 ft. (90 m) in rural areas. However, in areas of high traffic volume, where the potential exists for development which would create operational or safety problems, longer lengths of access control should be provided.

Source: A Policy on Design Standards Interstate System, AASHTO January 2005 page 2.

However, VDOT has established spacing standards for commercial entrances and intersections in the vicinity of interchanges which are much greater than the AASHTO limits mentioned above. These standards are in this Appendix in Table 2-3, Figure 2-9, Table 2-4 and Figure 2-10. Not meeting these standards will require an approved access management waiver (AM-E and AM-W), which can be accessed at <http://vdotforms.vdot.virginia.gov/SearchResults.aspx?IngDivisionID=40>.

* Added 7/17

GUIDELINES*

See the chart below for the categories for Types of Access Control.

CONTROL OF ACCESS	FULL	LIMITED OR PARTIAL	LIMITED OR PARTIAL	NONE
AASHTO Design Classification	Freeways	Arterials (Expressways) (Principal and Minor)	Collectors (Boulevards) (Major and Minor)	Local Streets and Roads (Thoroughfares)
Functional Purpose	High Mobility, Limited Access	High Mobility, Low to Moderate Access	Moderate Mobility, Low to Moderate Access	Moderate to Low Mobility, High Access
Design Speed	50 mph to 70 mph	30 mph to 70 mph	20 mph to 60 mph	20 mph to 50 mph

The following guidance is provided to assist in determining whether or not a facility should be granted any form of access control:

Level of Importance (Functional Classification) of Roadways within the Jurisdiction

- See chart above
- **Characteristics of System Roadways**
 - FHWA coordination and approval for all Interstate Systems
 - Documents both existing and proposed roadways features
 - Traffic volumes, including vehicle classification
 - Speed
 - Geometric design
 - Nature of the supporting street system
 - Level of proposed and existing access (connections)
- **Land Use and Growth Management Goals and Objectives**
 - Collaboration with Localities (Cities and Counties)
 - Future planning or growth management objectives
 - Land use
 - Density
 - Parcel size
 - Zoning restrictions

* Added 7/17

- **Current and Potential Future Presence of Pedestrians, Bicyclists and Transit** * See 2004 CTB Bicycle and Pedestrian Accommodations Policy at http://www.virginiadot.org/programs/resources/bike_ped_policy.pdf
 - Addressed by means of
 - Roadway and Traffic Engineering design standards and I&IMs
 - Traffic-calming practices
- **Engineering Judgment**
 - Prior experience with related roadway conditions

TYPES AND USAGE

Types of Access Control:

- **Full Control of Access**

Connections to a facility provided only via ramps at interchanges. All cross streets are grade separated. No private driveway connections are allowed. See Chapter 2E LIMITED ACCESS ESTABLISHMENT AND CHANGE GUIDELINES.
[http://www.extranet.vdot.state.va.us/locdes/Electronic_Pubs/2005%20RD M/chap2e.pdf](http://www.extranet.vdot.state.va.us/locdes/Electronic_Pubs/2005%20RD%20M/chap2e.pdf)
- **Limited Control of Access**

Connections to a facility provided via ramps at interchanges (major crossings) and at-grade intersections (minor crossings and service roads). No private driveway connections allowed. See Chapter 2E LIMITED ACCESS ESTABLISHMENT AND CHANGE GUIDELINES.
[http://www.extranet.vdot.state.va.us/locdes/Electronic_Pubs/2005%20RD M/chap2e.pdf](http://www.extranet.vdot.state.va.us/locdes/Electronic_Pubs/2005%20RD%20M/chap2e.pdf)
- **Partial Control of Access**

Connections to a facility provided via ramps at interchanges, at-grade intersections, and commercial and private entrances. Private driveway connections are normally defined as a maximum of one connection per parcel and should usually be limited to right-in / right-out. One connection is defined as one ingress and one egress point. The use of shared or consolidated connections is highly encouraged. Connections may be restricted or prohibited if alternate access is available through other adjacent public facilities.

* Added 7/17

- **No Control of Access**

Connections to a facility provided via ramps at interchanges, at-grade intersections, and private driveways. No physical restrictions, i.e., a control of access fence. Normally, private driveway connections are defined as one connection per parcel. Additional connections may be considered if they are justified and if such connections do not negatively impact traffic operations and public safety.*

Relationship of Functionally Classified Systems in Serving Traffic Mobility and Land Access

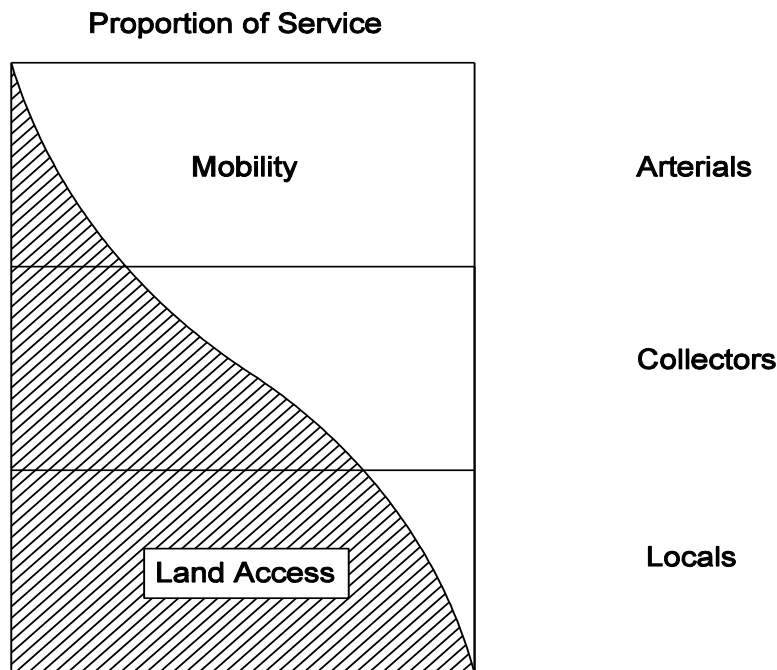

Source: 2011, AASHTO, *A Policy on Geometric Design of Highways and Streets*, Chapter 1, Section 1.2.3, page 1-7

It was pointed out in the discussion above that the concept of traffic channelization leads logically not only to a functional hierarchy of systems, but also to a parallel hierarchy of relative travel distances served by those systems. This hierarchy of travel distances can be related logically to a desirable functional specialization in meeting the access and mobility requirements. Local facilities emphasize the land access function. Arterials emphasize a high level of mobility for through movement. Collectors offer a compromise between both functions. This is illustrated conceptually above.

Functional classification can be applied in planning highway system development, determining the jurisdictional responsibility for particular systems, and in fiscal planning. These applications of functional classification are discussed in "*A Guide for Functional Highway Classification*."

* Rev. 7/17

SECTION 2 – INTERSECTION DESIGN; SPACING STANDARDS

Intersection Design Objectives

Intersection design, including entrances, must consider the following items:

- Total approach traffic, design hourly volumes, and turning volumes.
- Composition of traffic (percent of passenger cars, buses, trucks, etc.)
- Operating speed of vehicles
- Functional Classification of Highways
- Adjacent land use
- Physical and Environmental Characteristics
- Pedestrian and Bicycle Accommodation

Major objectives of traffic design concern safety, operational efficiency and driver expectation through consideration of the following:

- The design should fit the natural transitional paths and operating characteristics of drivers and vehicles. Smooth transitions should be provided for changes in direction.
- Grades at intersections should be as nearly level as possible.
- Sight distances must be sufficient to enable drivers to prepare for and avoid potential conflicts.
- On major roadways, intersections must be evenly spaced to enhance the synchronization of signals, increase driver comfort, improve traffic operation, and reduce fuel consumption and vehicle emissions.

Intersection Design Principles

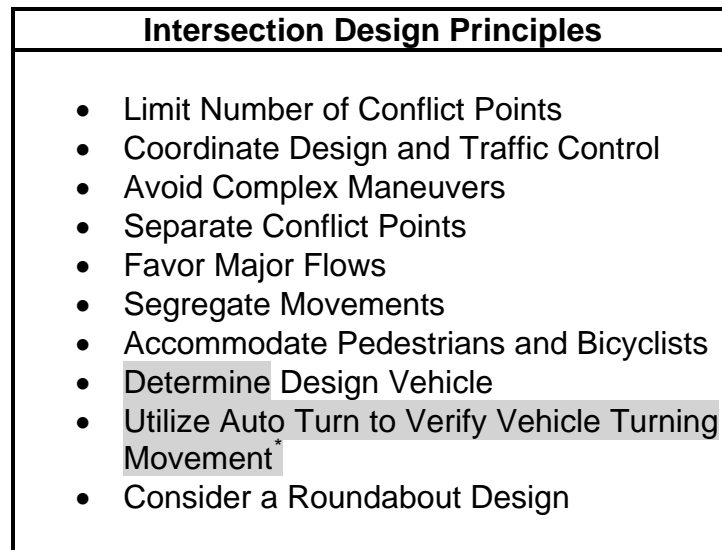

Intersection design principles are as follows:

- Limit the number of conflict points. The number of conflict points among vehicular movements increases significantly as the number of intersection legs increase. For example, an intersection with four two-way legs has 32 total conflict points, but an intersection with six two-way legs has 172 conflict points. Intersections with more than four two-way legs should be avoided wherever possible.

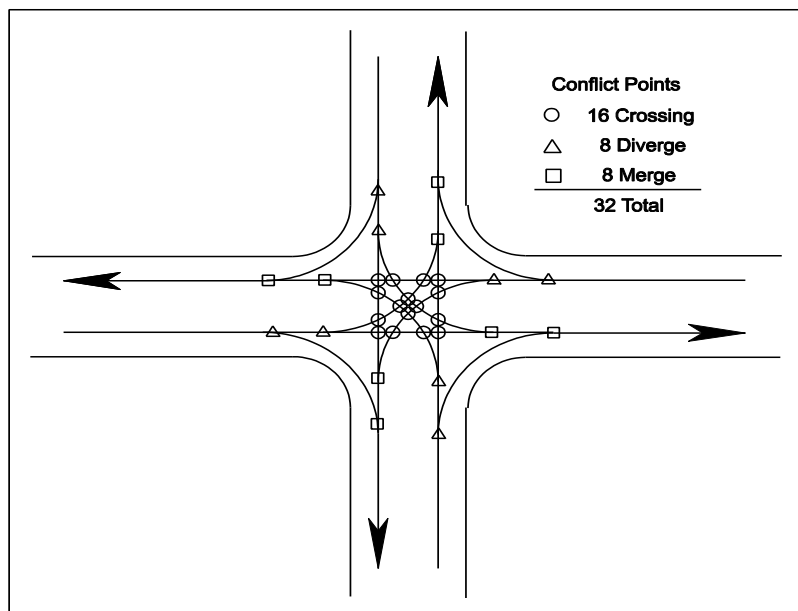

FIGURE 2-1 CONFLICT POINTS

Source: Transportation Research Board, *Access Management Manual*

* Rev. 1/14

- Coordinate design and traffic control. Maneuvers at intersections accomplished at low relative speeds require a minimum of traffic control devices. Maneuvers accomplished at high relative speeds are undesirable unless traffic controls such as stop signs or traffic signals are provided. Designs should separate vehicles making conflicting movements. Intersection design should be accomplished simultaneously with the development of traffic control plans.
- Avoid multiple and compound merging or diverging movements. These require complex driver decisions and create additional conflicts.
- Separate conflict points. Intersection hazards and delays are increased when intersection maneuver areas are too close together or when they overlap. Conflicts should be separated to provide drivers with sufficient time (and distance) between successive maneuvers for them to cope with the traffic conflicts one at a time.
- Favor the heaviest and fastest flows. The heaviest volume and higher speed flows should be given preference in intersection design to minimize hazard and delay.
- Minimize the area of the conflict. Excessive intersection area causes driver confusion and inefficient operations. Large areas are inherent with long curb return radii and in skewed and multiple-approach intersections. Channelization should be employed to limit the intersection and to guide drivers.
- Segregate movements. Separate lanes should be provided at intersections when there are appreciable volumes of traffic traveling at different speeds. Separate turning lanes should be provided for left and right turning vehicles. Left turns necessitate direct crossings of opposing vehicle paths and are usually made at speeds of 10 mph or less for reasons of safety and economy.

Right turns are also usually made at minimum speeds. However, right turns do not involve potential conflicts of such severity as left turns, and are more suited to individual treatment because they take place at the outside of the intersection area. Therefore, right turns may be designed for higher than minimum speeds where adequate right-of-way is available for wider turns.

- Accommodate the needs of pedestrians and bicyclists. For example, when pedestrians must cross wide streets, refuge islands are important for pedestrian safety. See Figures 3-25 and 3-28 for illustrations. The VDOT web page [Bicycling and Walking in Virginia](#) provides information on VDOT policies for accommodating pedestrians and bicyclists on state highways.

A detailed discussion on adapting highways for pedestrians and bicyclists is presented later in this section.

- Consider the design vehicle. The shapes and dimensions of turning paths vary for different turning speeds, different angles of turn, and different types and sizes of vehicles. The design vehicle must be identified and utilize Auto Turn to verify the design.* See Table 4-1 for Design Vehicle Chart.
- Consider a roundabout design. Roundabouts offer an attractive design alternative to conventional intersections. Roundabouts are circular intersections with specific design and traffic control features that convert all vehicular movements to right turns and force traffic to enter and circulate at lower, more consistent speeds. The safety benefits of low vehicle speeds include less severe and less frequent crashes. See the Roundabouts Section for additional information on the use of, and VDOT's efforts to promote, roundabouts.

At-grade intersections must provide adequately for anticipated turning and crossing movements. AASHTO's *A Policy on Geometric Design of Highways and Streets*, "Intersections" should be reviewed for additional information to be considered in the design since the site conditions, alignment, sight distance, the need for turning lanes and other factors enter into the type of intersection design which would satisfy the design hour volume of traffic, the character or composition of traffic, and the design speed.

A Highway Capacity Manual (HCM) capacity or other appropriate analysis (Corsim/Synchro) shall be performed for intersection capacity and signalization requirements, and include a queuing analysis.

Sufficient offset dimensions, pavement widths, pluses, and radii shall be shown in the plans by the Engineer to insure that sign islands are properly positioned. Care should be taken in the design of four-lane roadways with intersecting two-lane roadways.

If traffic conditions clearly warrant a four-lane divided design for the two-lane road at the intersection, the divided design must be constructed for a sufficient distance to allow for the approaching divided design and the subsequent stop condition ahead to be properly signed. The four-lane divided design should not be constructed unless it is clearly warranted and the approaches can be properly signed or the minor road is expected to be improved to a divided status in the near future.

* Rev. 1/14

Examples of typical geometric design applications are presented in Figures 2-3 and 2-4. Note: These examples are not all-inclusive. Other options maybe developed, which would require VDOT approval.

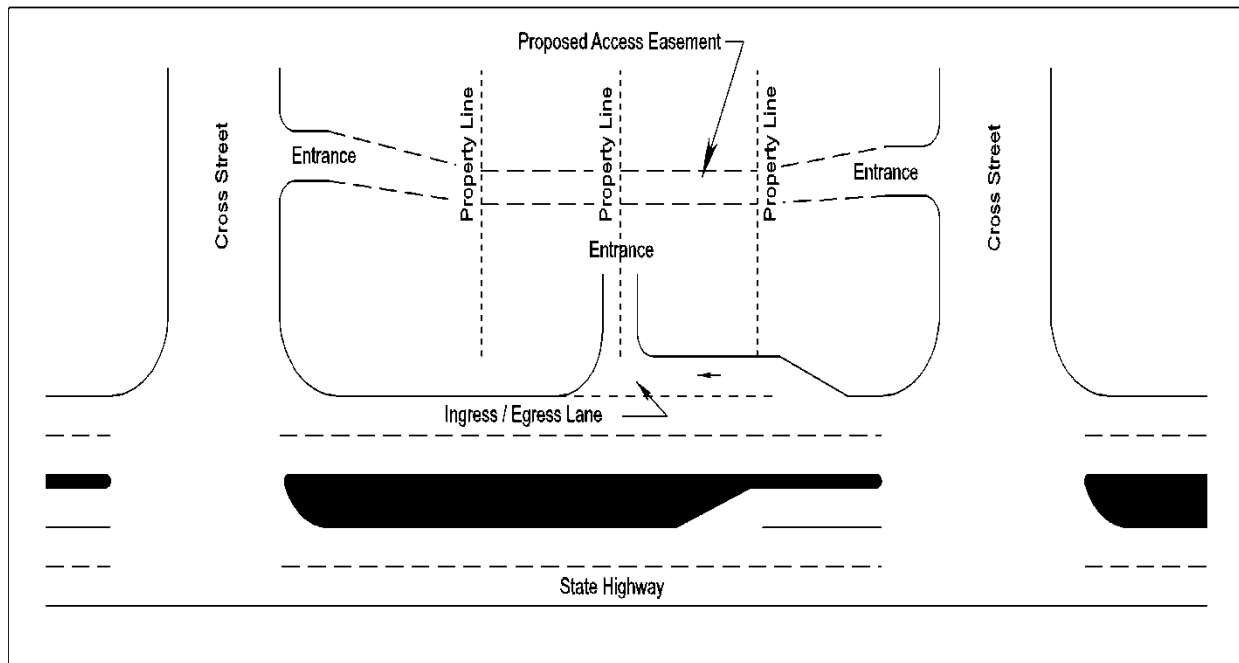

FIGURE 2-2 VEHICULAR CIRCULATION BETWEEN ADJOINING PROPERTIES

[Reg. 24VAC 30-73-120.C4](#)*

Note: All entrance design and construction shall accommodate pedestrian and bicycle users of the highway in accordance with the Commonwealth Transportation Board's "Policy for Integrating Bicycle and Pedestrian Accommodation

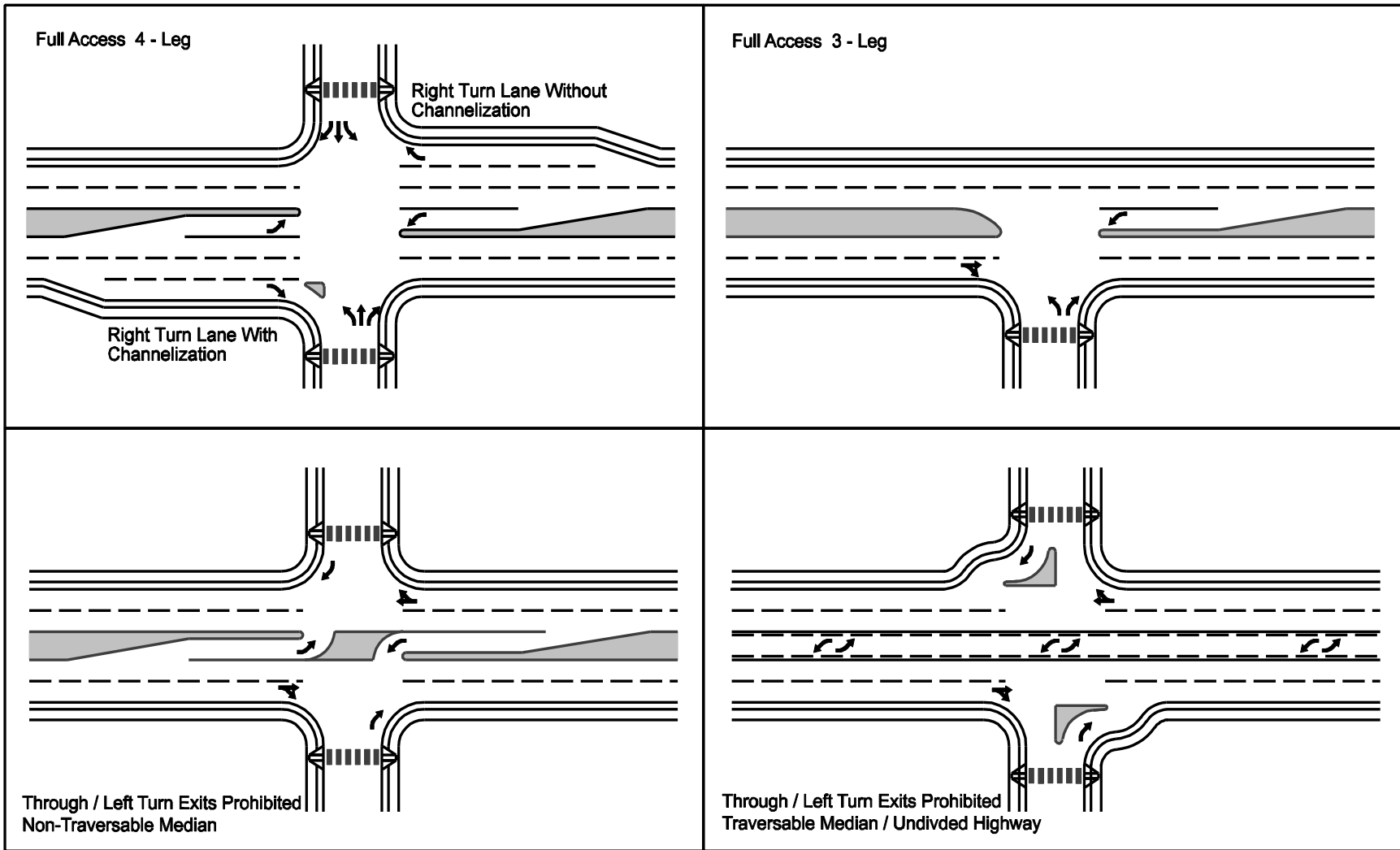

FIGURE 2-3 TYPES OF ACCESS CHANNELIZATION

Note: All entrance design and construction shall accommodate pedestrian and bicycle users of the highway in accordance with the Commonwealth Transportation Board's "Policy for Integrating Bicycle and Pedestrian Accommodations".

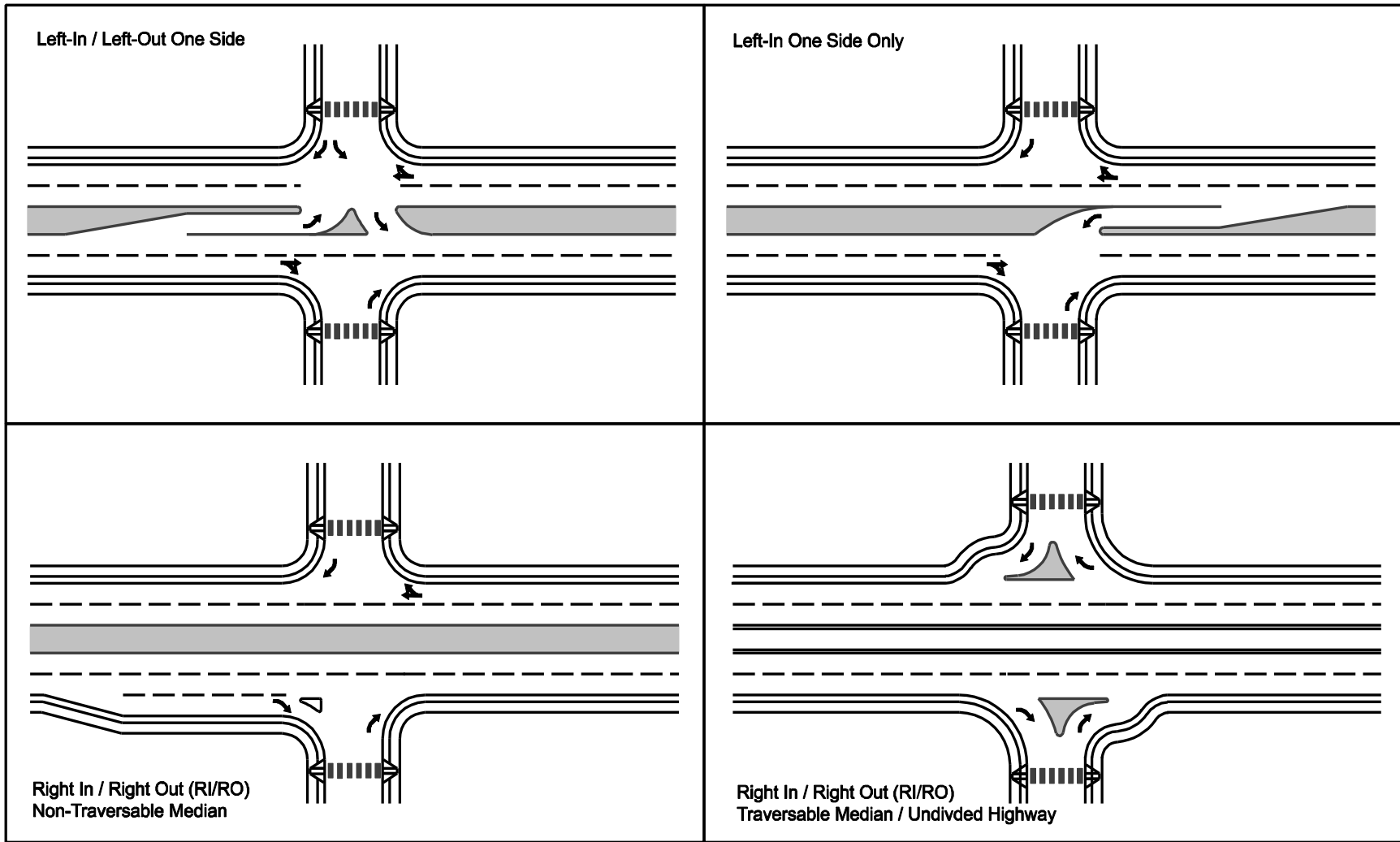

FIGURE 2-4 TYPES OF ACCESS CHANNELIZATION

Note: All entrance design and construction shall accommodate pedestrian and bicycle users of the highway in accordance with the Commonwealth Transportation Board's "Policy for Integrating Bicycle and Pedestrian Accommodations".

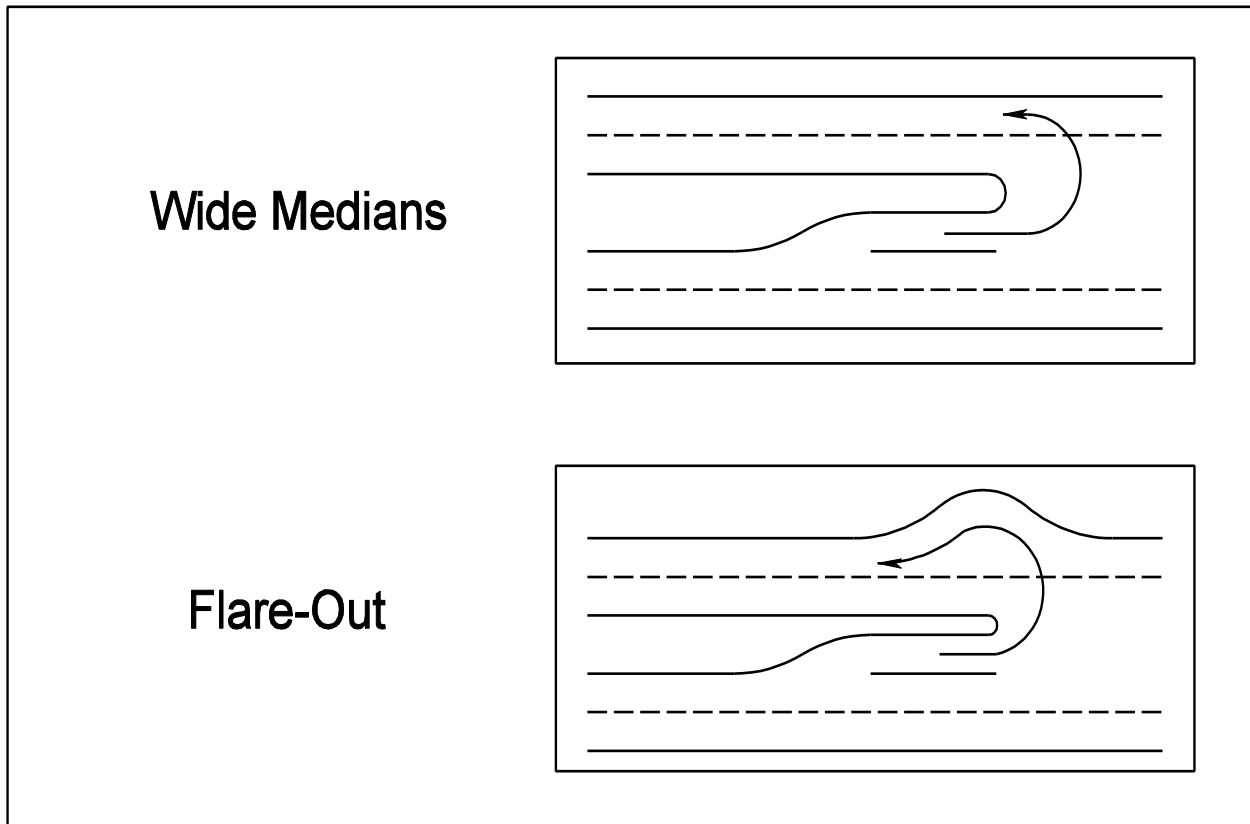
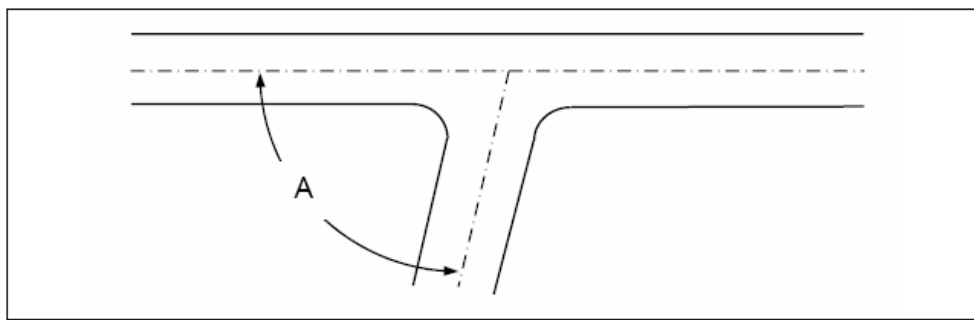

FIGURE 2-5 U-TURN DESIGN OPTIONS

Minimum Angle of Intersections

Streets should intersect at right angles; however, intersecting angles between 60 and 90 degrees are allowed.



Source: AASHTO "Green Book", Section 9.4.2, page 9-25* A = Minimum 60 degrees

FIGURE 2-6 MINIMUM ANGLE OF INTERSECTIONS

* Rev. 7/18

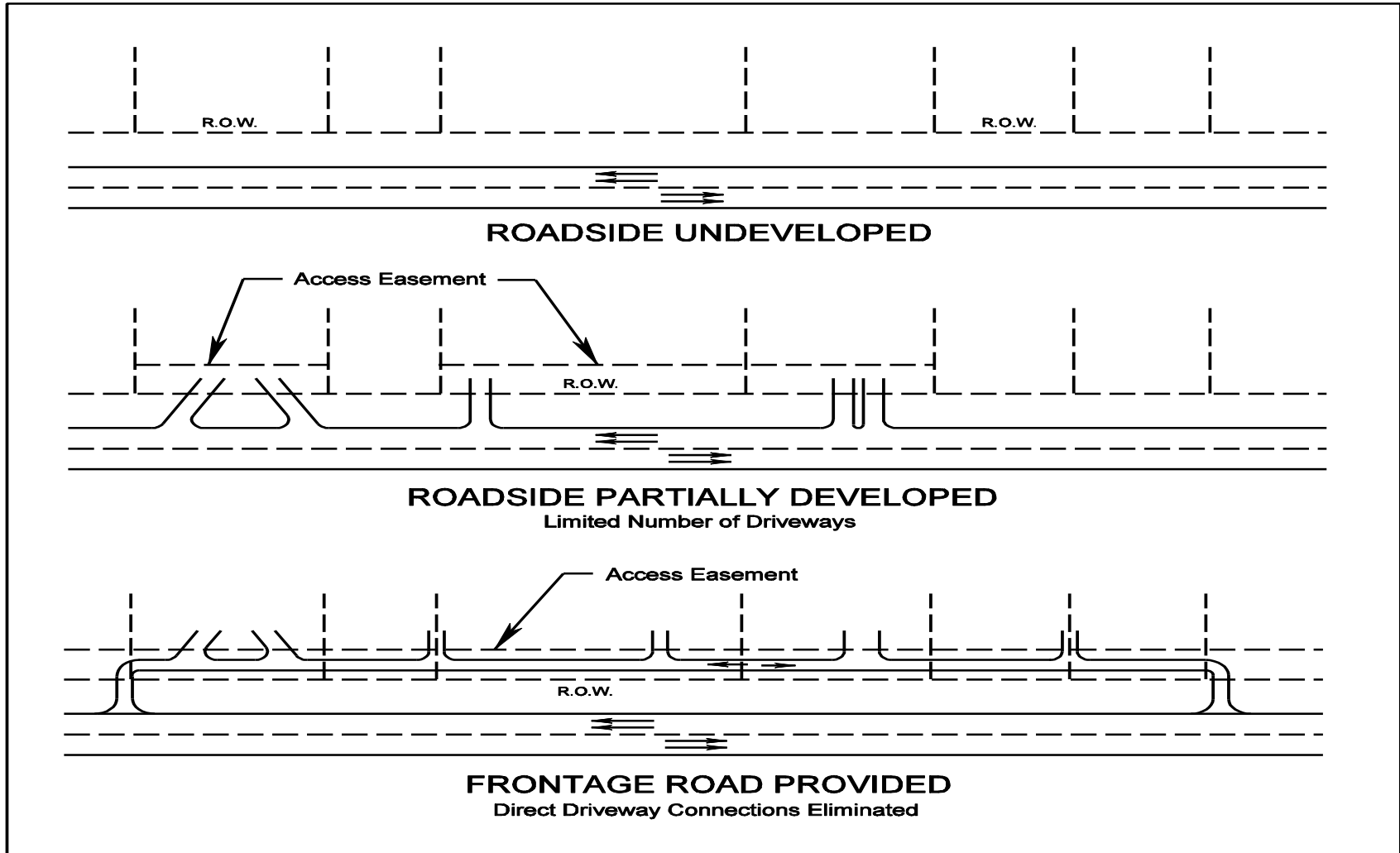
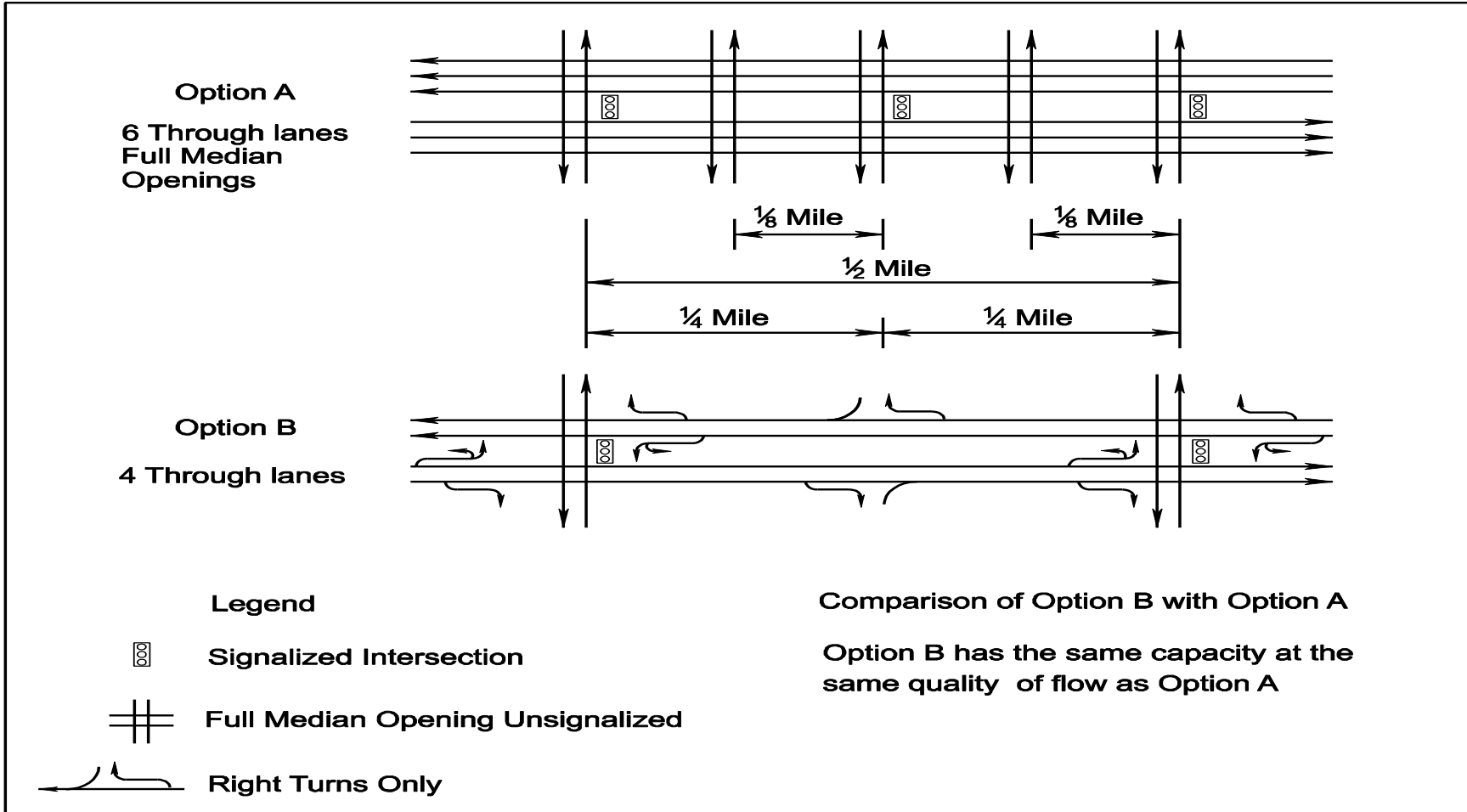

FIGURE 2-7 ACCESS DEVELOPMENT SCENARIO ALONG A STATE HIGHWAY

Note: All entrance design and construction shall accommodate pedestrian and bicycle users of the highway in accordance with the Commonwealth Transportation Board's "Policy for Integrating Bicycle and Pedestrian Accommodations".

ILLUSTRATION OF ENTRANCE AND INTERSECTION SPACING



Source: TRB, *Access Management Manual*, Dated 2003

FIGURE 2-8 ILLUSTRATION OF ENTRANCE AND INTERSECTION SPACING

Signalized Intersection Spacing

One of the variables involved in the planning, design and operation of signalized arterial streets is “Signalized Intersection Spacing” (See Table 2-2). Efficient traffic progression is essential on arterials in order to maximize safety and capacity. Moreover, at high progression efficiencies, fewer vehicles are required to come to a stop. Deceleration noise is reduced: thus, vehicle emissions, fuel consumption and delay are minimized. Since capacity will always be an issue on an urban arterial once urban development has occurred, the signal spacing must be such that very high progression efficiencies can be obtained over a wide range of through and turn volumes which change over time and which differ by time of day.

Selecting long and uniform signalized intersection spacing is an essential element in establishing spacing standards. Several studies have found that the number of crashes and crash rates increases with the frequency of traffic signals. For example an increase in signal density from 2.0 or less to 2.1 to 4.0 signals per mile can result in a 70% increase in the average crash rate – from about 2.8 to 4.8 crashes per million vehicle miles. The increased number of signals per mile also results in poor fuel efficiency and excessive vehicle emissions.

(Source: TRB *Access Management Manual*. 2003)

Signalized Intersection Spacing
<ul style="list-style-type: none"> • Essential to Movement Function • Parameters <ul style="list-style-type: none"> - Speed - Cycle Length (“Green” Band desired) - Signal Spacing - Efficiency of Progression - Vehicle Mix - Grade - Queuing - Emergency Preemptions

Source: NHI Course No. 15255, additions made by Committee.

Arterials are intended to provide a high degree of mobility and serve the longer trips. Since movement, not access, is the principal function, access management is essential in order to preserve capacity and safety. [AASHTO’s “*A Policy on the Geometric Design of Highways and Streets*” (Green Book)]. Further, the adoption of functional design, in lieu of volume based design, represents a major change in the philosophy of planning and design of street and highway systems.

A uniform signal spacing of ½ mile provides for efficient signal progression at speeds of 30 mph to 60 mph along arterials. At these speeds maximum flow rates are achieved and fuel consumption and emissions are kept to a minimum.

Generally a ½ -mile spacing will enable traffic flow at a wide range of speeds with cycle lengths ranging from 60 to 120 seconds. ½-mile spacing is needed to provide efficient progressions at 30 mph with a 120-second cycle commonly used in developed urban areas during peak hours. At slower speeds the increase in headway will result in a serious reduction in flow rate. (Source: TRB *Access Management Manual*. 2003)

Cycle Length (s)	Spacing			
	1/8 mi (600 ft)	1/4 mi (1,320 ft)	1/3 mi (1,760 ft)	1/2 mi (2,640 ft)
	Progression Speed (mph)			
60	15	30	40	60
70	13	26	34	51
80	11	22	30	45
90	10	20	27	40
100	9	18	24	36
110	8	16	22	33
120	7.5	15	20	30

TABLE 2-1 RELATIONSHIP BETWEEN SPEED, CYCLE LENGTH, & SIGNAL SPACING

Source: TRB: *Access Management Manual*, 2003

General Intersection and Entrance Spacing Criteria

1. Functional classification of highway
 - Purpose of the highway for mobility vs. access to property
2. Highway speed limit
 - The higher the speed, the longer the distance to safely decelerate for turning movements
3. Traffic signal
 - Separation of signals for efficient traffic progression
4. Type of entrance or intersection
 - As the potential number of turning movements increases, so do the conflict points, leading to a greater potential for traffic crashes, particularly for left turns into and out of entrances or at intersections

Other criteria that may need to be considered for new **median*** crossover spacing is presented later in this section.

* Rev. 1/14

Minimum Spacing Standards for Commercial Entrances, Intersections, and Median Crossovers

Highway Functional Classification	Legal Speed Limit (mph) ^①	Minimum Centerline to Centerline Spacing (Distance) in Feet			
		Spacing from Signalized Intersections to Other Signalized Intersections ^②	Spacing from Unsignalized Intersections & Full Median Crossovers to Signalized or Unsignalized Intersections & Full Median Crossovers ^③	Spacing from Full Access Entrances or Directional Median to Other Full Access Entrances and Any Intersection or Median Crossover ^④	Spacing from Partial Access One or Two Way Entrances to Any Type of Entrance, Intersection or Median Crossover ^⑤
Principal Arterial	≤ 30 mph	1,050	880	440	250
	35 to 45 mph	1,320	1,050	565	305
	≥ 50 mph	2,640	1,320	750	495
Minor Arterial	≤ 30 mph	880	660	355	200
	35 to 45 mph	1,050	660	470	250
	≥ 50 mph	1,320	1,050	555	425
Collector	≤ 30 mph	660	440	225	200
	35 to 45 mph	660	440	335	250
	≥ 50 mph	1,050	660	445	360
Local Street ^⑥	See Note 6*				

TABLE 2-2 MINIMUM SPACING STANDARDS FOR COMMERCIAL ENTRANCES, INTERSECTIONS AND MEDIAN CROSSOVERS^⑦

Notes:

- A. Definitions** – See the Definitions section for explanations of terms used in Table 2-2.
- B. Entrances** – The entrance spacing applies to entrances on the same side of the highway.
- C. Entrance offset** – See Figure 4-6 for Offsetting entrances on opposite sides of a roadway.
- D. Right turn lanes** – When a right turn lane will be installed at an entrance, the length of the turn lane needs to be considered when locating the entrance.
- E. Roundabouts** –
 - Are separated from signalized intersections and unsignalized intersections/median crossovers by the Unsignalized Intersection spacing standard and from full access and partial access entrances by the Partial Access Entrance spacing standard.
 - Are separated from other roundabouts by the Partial Access Entrance spacing standard.
 - Are measured from the outer edge of the inscribed circle diameter (Yield Line).

Footnotes to Table 2-2

① **Legal Speed Limit** – The speed limit set forth on signs lawfully posted on a highway or in the absence of such signs the speed limit established by Article 8 (§46.2-870 et seq.) of Chapter 8 of Title 46.2 of the Code of Virginia.

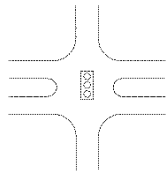

② **Signalized Intersection**– Spacing is allocated in fractions of a mile: (1/2 mile, 2,640 ft); (1/3 mile, 1,760 ft); (1/4 mile, 1,320 ft); (1/5 mile, 1,050 ft); (1/6 mile, 880 ft), (1/8 mile, 660 ft). It is based on (i) the Signalized Intersection Spacing section and Table 2-1 and (ii) *Transportation and Land Development* by Vergil Stover and Frank Koepke, Institute of Transportation Engineers: “Traffic signal control applied in a sequential pattern according to specific spacing criteria optimize traffic efficiency” ...”to reduce fuel consumption, reduce delay, reduce vehicular emissions and improve safety.”

③ **Unsignalized Intersection/Full* Median Crossover** – Intersections and full median crossovers need ample spacing to accommodate the complex situations faced by motorists from vehicular deceleration, acceleration, and numerous conflict points associated with vehicular movements such as crossing and left and right turns. At a four way intersections, these traffic movements’ create 32 conflicts (collision) points (see Figure 2-1). Intersections and full median crossovers also may become signalized over time. Spacing is allocated in fractions of a mile (see footnote 2). **Note:** Roundabouts are separated from signalized and unsignalized intersections/median crossovers by this spacing standard.

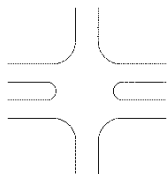

④ **Full Access Entrance or Directional Median Crossover Spacing** – Spacing can be less than unsignalized intersection and full median crossover spacing. Full access entrances have only 11 potential conflict (collision) points and directional crossover only 6. However, studies have demonstrated that the majority of access related vehicular crashes involve multiple left turn movements. The spacing is based on intersection sight distance for both four and two lane highways to assure that motorists approaching an entrance and those turning out of the entrance have sufficient time to react to highway and entrance traffic and to merge safely when making right and left turns. Again the purpose is to maintain the capacity and safety of the highway.

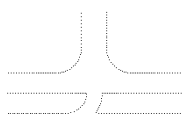
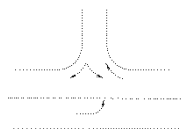

⑤ **Partial Access One or Two Way Entrance Spacing** – Left turn movements are limited (right in/right out with or without left in only movement). If a directional median crossover is involved the directional median crossover spacing applies to the entrance. The focus is on making sure motorists have sufficient time to be able to see/react to a vehicle slowing down to turn into the entrance or to a vehicle exiting the entrance, and stop in time to avoid a collision. Stopping sight distance can be used for this purpose. See Figure 4-4 for illustrations of right in/right out with or without left in commercial entrance channelization island options. Also see “Restricting Left Turn Movements at Commercial Entrances” for additional information. **Note:** Roundabouts are separated from other roundabouts by the partial access entrance spacing standard.

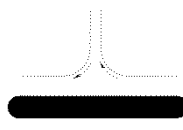

* Rev. 7/14

- ⑥ **Local Street Spacing** – No commercial entrance shall be allowed within the functional area of an intersection without prior approval from the Engineer at the Residency or District.* For commercial entrances on local streets (not individual private entrance driveways to homes), a spacing distance of 50 feet between entrance radii is specified to assure a minimum separation between such entrances (illustrated in Figure 4-11).

No commercial entrance shall be within 115 feet minimum measured from the outer edge of the inscribed circle of a Roundabout, without prior approval from the Engineer at the Residency or District. If an entrance is approved within the 115 feet of the outer edge of the inscribed circle it shall be "Right-In, Right-Out" Only (115' feet minimum is based on the stopping sight distance for 20 mph).

- ⑦ **Corner Clearance** – Corner clearance is the minimum distance entrances on a minor side street need to be separated from an intersection to prevent queued vehicles from backing up into the highway or blocking entrances near the intersection. This separation protects the functional area of the intersection. The corner clearance distance will apply where it is greater than the Table 2-2 spacing standard. See Corner Clearance in Section 4 for more information.

* Rev. 7/17

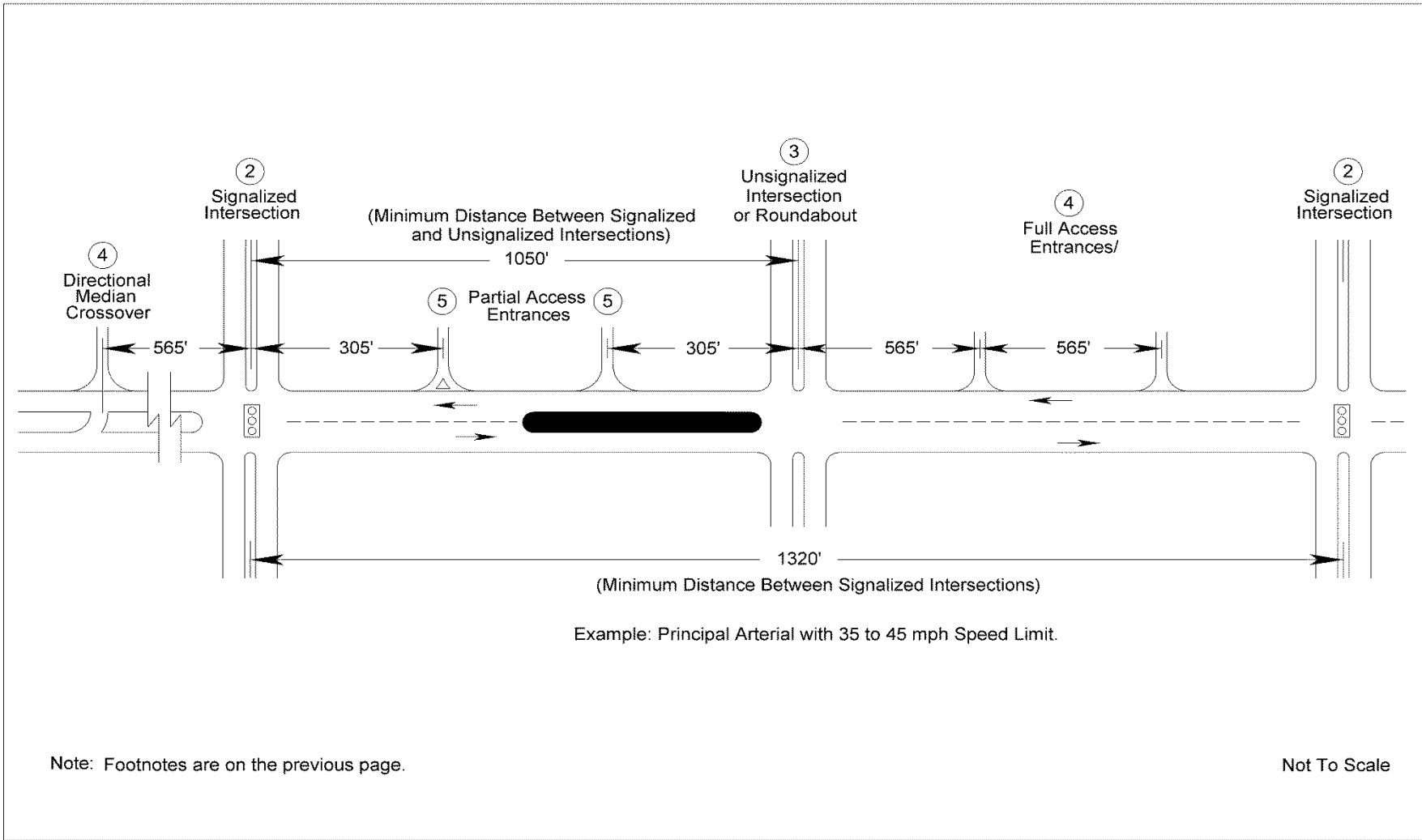

FIGURE 2-8.1 ILLUSTRATION OF THE RELATIONSHIP BETWEEN SPACING STANDARDS*

* Rev. 7/14

Spacing Standards for Commercial Entrances/Intersections Near Interchange Ramps

The spacing standards near interchange ramps focus on safe ramp exit and entry movements. Greater separation between Ramp Terminals (see definition of Ramp Terminal) and entrances and intersections is necessary for multilane versus two-lane highways because the motorist's maneuvers at multilane roads are more complex, such as crossing through lanes to reach a left turn lane at an intersection. Functional classification is not applied because arterials may be two lane or multilane. If the off and/or on ramp connects to a continuous auxiliary lane, the spacing distance is measured from where the AASHTO calculated acceleration or deceleration lane and taper would end if there were no continuous auxiliary lane. Note: For Limited Access Line, Fence Requirements and 100' Urban / 300' Rural FHWA minimum access control, See Figures 2E-10 and 2E-11* in Chapter 2E of the Road Design Manual.

Minimum Spacing Standards for Intersections and Commercial Entrances Near Interchange Areas on <u>Multilane</u> Crossroads (These Spacing Standards Apply to Both Signalized Intersections and Commercial Entrances Regardless of the Interchange Configuration)		
X	Y	M
750'	1320'	990'

TABLE 2-3 MINIMUM SPACING STANDARDS FOR INTERSECTIONS AND COMMERCIAL ENTRANCES NEAR INTERCHANGE AREAS ON MULTILANE CROSSROADS

Source: *Access Control Design on Highway Interchanges, 2008.*

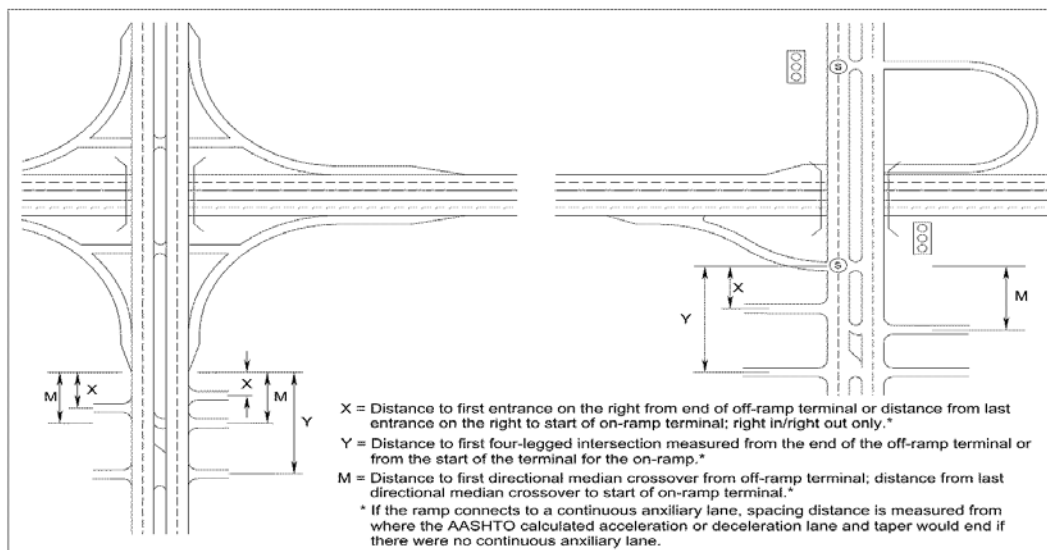

FIGURE 2-9 ACCESS CONTROL ON MULTI LANE HIGHWAYS AT INTERCHANGES

* 7/16

Minimum Spacing Standards for Intersections and Commercial Entrances Near Interchange Areas on <u>Two-Lane</u> Crossroads	
(These Spacing Standards Apply to Both Signalized and Unsignalized Intersections and Commercial Entrances Regardless of the Interchange Configuration)*	
X or Z	Y
750'	1320'

TABLE 2-4 MINIMUM SPACING STANDARDS FOR COMMERCIAL ENTRANCES AND INTERSECTIONS NEAR INTERCHANGE AREAS ON TWO-LANE CROSSROADS

Source: *Access Control Design on Highway Interchanges, 2008.*
 H. Rakha, A. M. Flintsch, M. Arafeh, G. Abdel-Salam, D. Dua, and M. Abbas.
 Virginia Tech Transportation Institute, Blacksburg, VA

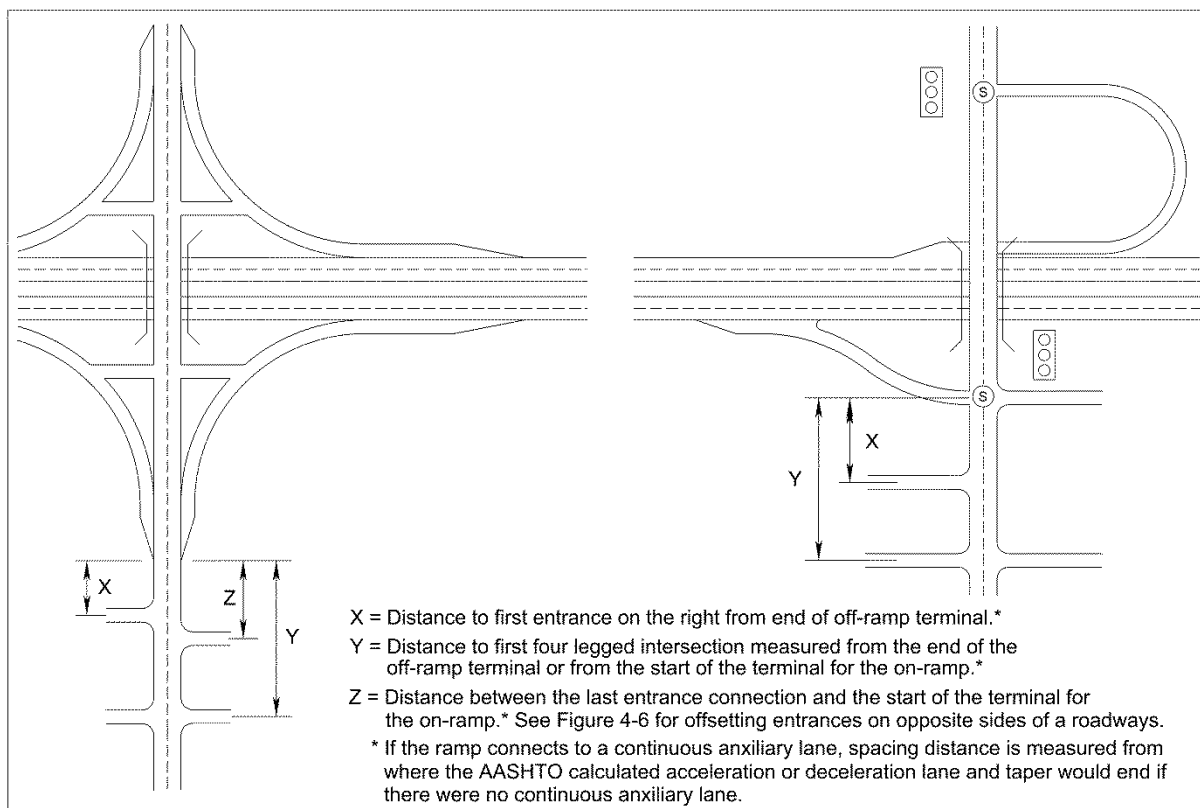

FIGURE 2-10 ACCESS CONTROL ON TWO LANE HIGHWAYS AT INTERCHANGES

* Rev. 1/16

Exceptions/Waivers to the Spacing Standards/Access Management Requirements

The Access Management Regulations (24VAC30-73-120) identify potential exceptions to the spacing standards for commercial entrances, intersections, and median crossovers found in Tables 2-2 through 2-4 and Figure 4-4 corner clearance in this Appendix. The Regulations also establish access management requirements for shared use entrances, cross parcel access, and functional area of intersections and identify potential exceptions to these requirements. Exceptions to the spacing standards and access management requirements are referenced in section 24VAC30-73-120 of the Access Management Regulations. See the VDOT Access Management web page for the regulations at www.virginiadot.org/projects/accessmgt.

For commercial entrances, intersections, and median crossovers (new or to be relocated) proposed for private sector land development projects, the Access Management Regulations specify the documentation to be submitted to justify an exception to the spacing standards and access management requirements. A request for an exception shall be submitted to the District Engineer/Administrator or designee using Exception Form [AM-E](#). This form is available on the VDOT web site at <http://vdotforms.vdot.virginia.gov/>.

For highway construction or reconstruction projects on roadways owned and maintained by VDOT, a request for a waiver to the spacing standards shall be submitted to the District Location and Design Engineer using Waiver Form [AM-W](#). This form is available on the VDOT web site at <http://vdotforms.vdot.virginia.gov/>.

Exceptions / Waivers to the Design Standards

For both land development and highway construction projects **on VDOT owned and maintained roadways only**, the appropriate intersection sight distance from Table 2-5 must be met for all commercial entrances, intersections, and median crossovers. If intersection sight distance cannot be met and a design waiver is granted (see below), then the minimum stopping sight distance from [Table 2D-1](#) in Chapter 2D* must be met.

If stopping sight distance cannot be met, a request for a design exception (Form [LD-440](#)) shall be submitted. If intersection sight distance cannot be met, a request for a design waiver (Form [LD-448](#)) shall be submitted. See [IIM-LD-227](#) for information on the exception and waiver review process for sight distance. [IIM-LD-227](#) is available at <http://www.virginiadot.org/business/locdes/rd-ii-memoranda-index.asp>.

Section 24VAC30-73-50B in the Access Management Regulations also provides details on the stopping sight distance exception process.

For both private developments and highway construction projects, if any design standard in Appendix F (everything except Tables 2-2, 2-3, 2-4 spacing standards, corner clearance, shared use entrances, cross parcel access, and functional area of intersections) cannot be met, a request for a design exception (Form [LD-440](#)) or design waiver (Form [LD-448](#)) shall be submitted in accordance with [IIM-LD-227](#), available on the VDOT web site at <http://www.virginiadot.org/business/locdes/rd-ii-memoranda-index.asp>.

* Rev. 1/16

Traffic Signals and Median Crossovers*

Certain roads within Virginia are now being designated as “Mobility Preservation Segments” (MPS’s) – major roadways outside of Urban Areas that serve a critical function for interurban mobility where no parallel Interstate/freeway route exists.

In addition, other roads within Virginia are designated as “Mobility Enhancement Segments” (MES’s) – major roadways inside of Urban Areas where there may be opportunities to improve traffic flow without major widening.

See [IIM-TMPD-2.0](#) for more information on the Arterial Preservation Network (MPS’s and MES’s).

The [Arterial Preservation Network \(APN\)](#) is shown on a statewide map.

Traffic signals and median crossovers offer potential benefits to intersection operations, capacity, and safety. However, if traffic signals are unjustified, designed (timing and phasing) or spaced improperly, they can have adverse impacts on motorist operations, capacity and safety. Median crossovers that are unjustified or spaced improperly can also have adverse impacts on motorist operations, capacity and safety. Therefore, the removal of traffic signals and median crossovers is desirable when it can be done safely.

Below is VDOT’s policy on Traffic Signals and Median Crossovers:

Removal of a Traffic Signal

Following engineering review of current signal operations, timings and traffic patterns, a decision can be made to eliminate a signal. The removal should be phased to include determining the type of control necessary post-signal, removing sight distance obstacles, informing the public of the potential removal, flash or cover the heads for 90 days and analyze the operations and remove the signal if the data confirms the signal is no longer warranted. There is no official appeal process for the removal of a traffic signal. For further details, see ([MUTCD Chapter 4B](#)).

- **Responsible Person:** District Traffic Engineer

* Added 7/17

Installation of a Traffic Signal ([24VAC30-315-10](#))

The selection and use of traffic control signals should be based on an engineering study of roadway, traffic, and other conditions, analyzing traffic, pedestrian and bicycle operations and needs and the series of signal warrants included in the MUTCD, including peak hour, 4-hour and 8-hour vehicular volumes, pedestrian volumes, school or grade crossings, roadway network and coordinated signal systems and crash experience and application of the Access Management Spacing Standards. The proposed installation of any new traffic signals on Mobility Preservation Segments” (MPS’s) shall be approved by the State Traffic Engineer, as proposed in [TE I&IM 387](#). There is no official appeal process for a denied traffic signal. For additional details see: [MUTCD Chapters 4B & 4C](#); RDM App. F, Table 2-2; [TE-IIM-387](#).

Innovative Intersections/interchanges, including grade separated interchanges and roundabouts, as detailed in [Appendix A-3](#), are to be considered and analyzed when constructing or reconstructing new signalized or unsignalized intersections. Roundabouts are the preferred alternative if a study shows that they are feasible. On any roadway corridor designated by the CTB as a Mobility Preservation Segment (MPS), intersections or new access points which meet warrants for traffic shall not have a new traffic signal installed until these alternatives have been evaluated and determined to be not appropriate for the location. For additional details see: [VA Supplement to the MUTCD Part 4](#).

- Responsible Person: State Traffic Engineer for MPS and District Traffic Engineer for all other roadways.

Addition, Relocation and/or Closing of a Median Crossover

Median Crossover Location Approval Process:

Overview

Tables 2-2 through 2-5 show the minimum median crossover spacing and sight distance requirements to be applied on all divided highways without full control of access. Median crossovers not meeting these minimums will only be allowed after an individual traffic safety and operational study and approval as outlined below.

The following are some factors, but not all inclusive, that should be considered in the study, if applicable: Operating speed, volume and composition of traffic for median crossover and through routes, signal operation and traffic progression, accidents with and without additional median crossover, number of U-turns, weaving maneuvers, alternative solution(s), capacity analysis, etc.

All Additions, Relocations and/or Closings of a Median Crossover require approval as indicated on the following pages.*

* Rev. 7/18

Median Crossovers Requested by the Private Sector (MPS)

Any new median crossover designated MPS are to be approved by the State Location & Design Engineer. The basic process is the same as for non-MPS roadways (see below).

- **Responsible Person:** State Location and Design Engineer (New Median Crossovers) *

The District Transportation and Land Use Director should consult with the responsible District Traffic Engineer concerning private sector (developer) requests to relocate or close an existing median crossover on VDOT owned and maintained highways. **A median crossover request that complies with the spacing standards, the sight distance requirements, and all other engineering standards may be approved by the District Engineer/Administrator or designee.**

- **Responsible Person:** District Traffic Engineer

Median Crossovers Requested by the Private Sector (Non-MPS)

The District Transportation and Land Use Director should consult with the responsible District Traffic Engineer concerning private sector (developer) requests for a new median crossover or to relocate or close an existing median crossover on VDOT owned and maintained highways. **A median crossover request that complies with the spacing standards, the sight distance requirements, and all other engineering standards may be approved by the District Engineer/Administrator or designee.**

- **Responsible Person:** District Traffic Engineer

For private sector project related median crossover requests **that do not meet the spacing standards**, a spacing exception must be approved by the District Engineer/Administrator or designee as described in the “Exceptions to the Spacing Standards” section above. Traffic studies as outlined above must accompany the request for a median crossover location that does not meet the minimum spacing standards.

- **Responsible Person:** District Traffic Engineer

The approval of the addition, relocation or closing of median crossovers on an existing VDOT highway **that do not meet the sight distance requirements or other engineering standards** shall be the duty of the responsible District Traffic Engineer with the concurrence of the State Location and Design Engineer. It shall be the duty of the responsible District Traffic Engineer to coordinate such changes with the State Location and Design Engineer in order that these revisions of median crossovers may be properly recorded on the original plans.

- **Responsible Person:** District Traffic Engineer and State Location & Design Engineer

* Rev. 7/18

Median Crossovers on a Highway Construction Project (MPS)

Any new median crossover on MPS is to be approved by the State Location & Design Engineer. The basic process for non-MPS roadways is the same (See below)., The closing of a median crossover is to be approved by the District Engineer/Administrator and the responsible District Traffic Engineer.*

- **Responsible Person:** State Location & Design Engineer (New Median Crossovers)
- **Responsible Person:** District Engineer/Administrator and responsible District Traffic Engineer (Closing a Median Crossovers)

Median Crossovers on a Highway Construction Project (Non-MPS)

The determination of any new median crossover or the closing of an existing median crossover shall be the result of field inspection recommendations of the District Engineer/Administrator and the responsible District Traffic Engineer.

- **Responsible Person:** District Engineer/Administrator and the responsible District Traffic Engineer

As part of a highway construction project, median crossover spacing less than shown as minimum in Tables 2-2 through 2-4, will be considered when required by existing intersecting public highways or streets with a current ADT of 100 or greater and must be submitted for approval to the District Location and Design Engineer using Form AM-W. All plans at the public hearing stage are to show only those median crossovers at public highways and streets which meet these criteria or at other locations that preliminary planning and traffic studies have warranted.

- **Responsible Person:** District Location & Design Engineer

The approval of median crossovers that do **not** meet sight distance or other engineering standards shall be the responsibility of the responsible District Traffic Engineer and the State Location and Design Engineer, with the final responsibility for the location of median crossover layout on plans resting with the State Location and Design Engineer. Plans at right-of-way stage are to indicate the median crossovers as determined and approved by the above criteria.

- **Responsible Person:** State Location & Design Engineer

* Rev. 7/18

Any plans that are revised during construction for the addition or deletion of median crossovers where spacing standards or engineering standards are **not** met shall be approved by the District Location and Design Engineer, the responsible District Traffic Engineer, and/or the State Location and Design Engineer in accordance with the approval process outlined above.

- **Responsible Person:** District Location and Design Engineer (Spacing), District Engineer/Administrator (Closings) or State Location and Design Engineer (Sight Distance) *

Signalized and Unsignalized Intersection Design (Corner Island Designs)

At-grade intersections must provide adequately for anticipated turning and crossing movements.

For shoulder (Rural) applications, Figures 2-11 and 2-12 provides the Engineer with the basic types of intersection designs and minimum dimensions, radii, skews, angles, and the types of island separations, etc. Also see AASHTO Green Book, Chapter 9, Section 9.6.3, page 9-102, Figure 9-39.

For curb and gutter (Urban) applications see AASHTO Green Book, Chapter 9, Section 9.6.3, page 9-101, Figure 9-38 (Intersections). This chapter provides additional information to be considered in the design since the site conditions, alignment, grades, sight distance and the need for turning lanes and other factors enter into the type of intersection design.

Sufficient offset dimensions, pavement widths, pluses, and radii shall be shown in the plans by the designer to insure that the sign island is properly positioned.

Care should be taken in the design of four-lane roadways with intersecting two-lane roadways. If traffic conditions clearly warrant a four-lane divided design for the two-lane road at the intersection, the divided design must be constructed for a sufficient distance to allow for the approaching divided design and the subsequent stop condition ahead to be properly signed. The four-lane divided design should not be constructed unless it is clearly warranted and the approaches can be properly signed or the minor road is expected to be improved to a divided status in the near future.

* Rev. 7/17

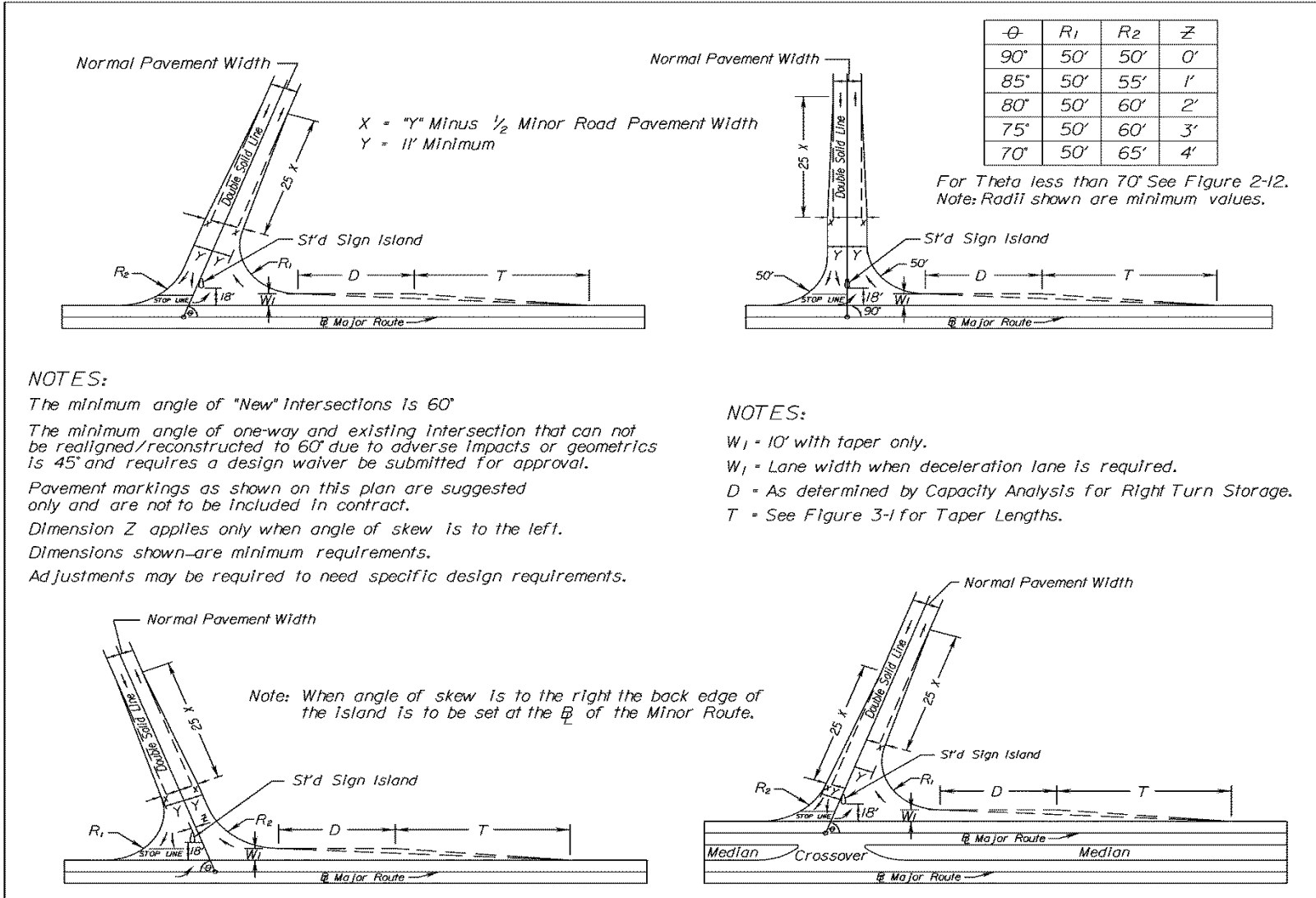

FIGURE 2-11 INTERSECTION DESIGN FOR RURAL APPLICATIONS WITH OR WITHOUT STANDARD SI-1 SIGN ISLAND DESIGN*

* Rev. 3/11

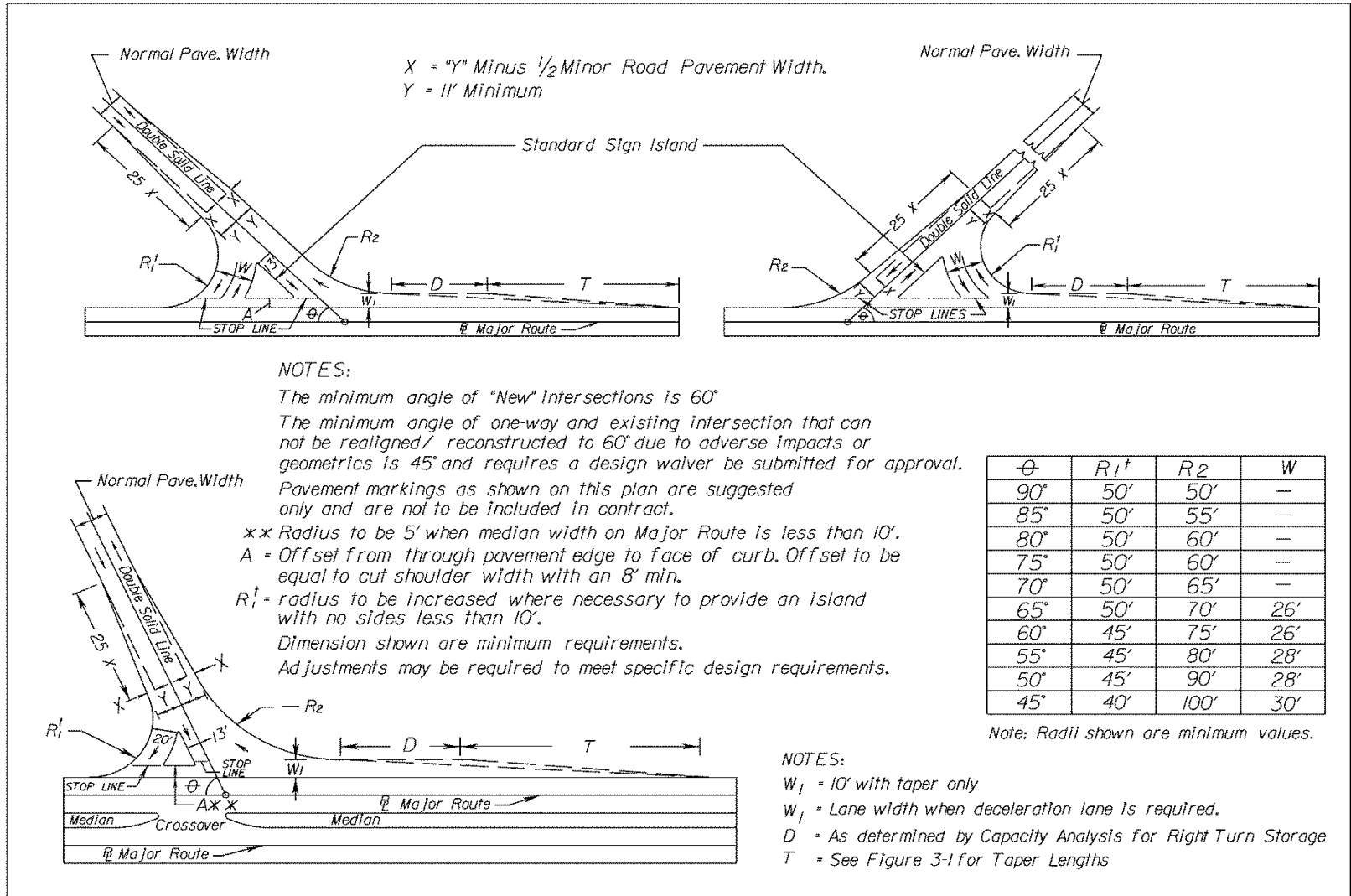
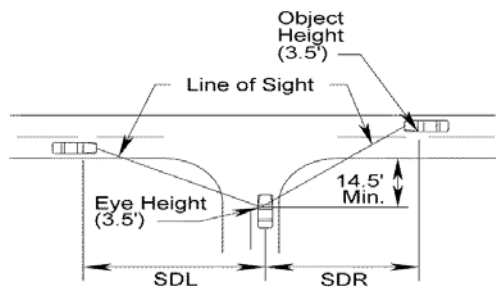

FIGURE 2-12 INTERSECTION DESIGN FOR RURAL APPLICATIONS WITH OR WITHOUT STANDARD SI-2 OR SI-3 SIGN ISLAND DESIGN*

* Rev. 3/11

Intersection Sight Distance

The following table shows intersection sight distance requirements for various speeds along major roads:



SDR = Sight Distance Right (For a vehicle making a left turn)
 SDL = Sight Distance Left (For a vehicle making a right or left turn)

Height of Eye 3.5'		Height of Object 3.5'										
Design Speed (mph)**		20	25	30	35	40	45	50	55	60	65	70
SDL=SDR: 2 Lane Major Road	In Feet	225	280	335	390	445	500	555	610	665	720	775
SDR: 4 Lane Major Road (Undivided) or 3 Lane		250	315	375	440	500	565	625	690	750	815	875
SDL: 4 Lane Major Road (Undivided) or 3 Lane		240	295	355	415	475	530	590	650	710	765	825
SDR: 4 Lane Major Road (Divided – 18' Median)		275	340	410	480	545	615	680	750	820	885	955
SDL: 4 Lane Major Road (Divided – 18' Median)		240	295	355	415	475	530	590	650	710	765	825
SDR: 5 Lane Major Road (continuous two-way turn-lane)		265	335	400	465	530	600	665	730	800	860	930
SDL: 5 Lane Major Road (continuous two-way turn-lane)		250	315	375	440	500	565	625	690	750	815	875
SDR: 6 Lane Major Road (Divided – 18' Median)		290	360	430	505	575	645	720	790	860	935	1005
SDL: 6 Lane Major Road (Divided – 18' Median)		250	315	375	440	500	565	625	690	750	815	875
SDL: (Where left turns are physically restricted)		210	260	310	365	415	465	515	566	620	670	725

TABLE 2-5 INTERSECTION SIGHT DISTANCE

Source: AASHTO Green Book, Chapter 9, Section 9.5.3, page 9-37 thru 9-52, * Table 9-5 thru 9-14

**For all tables, use design speed if available, if not use legal speed.

* Rev. 1/14

Note: Both SDR and SDL must be met at the entrance or intersection, unless left turns are physically restricted by a median or channelization island; then only SDL is needed. Intersection sight distance determinations apply both horizontally and vertically, measured in each direction, and are to be based on a height of driver's eye of 3.5' and a height of object 3.5'.

The term "Major Road" refers to the road with the higher functional classification, or if both have the same classification, the road with the higher volume.

Intersection sight distance does not control the access spacing for entrances and intersections shown in Table 2-2.

For major roadways of more than four lanes, large truck volumes on a minor road or median crossover, or median widths over 60', see AASHTO's *A Policy on Geometric Design of Highways and Streets*.

The Engineer must check each entrance and intersection to insure that adequate sight distance is provided. On a typical two-lane road horizontal curve there are numerous objects that restrict sight distance such as cut slopes, buildings, vegetation, vehicles, etc.

These obstructions should be considered when reviewing commercial entrances. A divided highway can have similar problems. It is very important to obtain adequate intersection sight distance for all "New" and "Reconstructed" commercial entrances from the entrance as well as the left turn position into the entrance. If the minimum intersection sight distance values in the table mentioned above cannot be met, including applying the adjustment factors for sight distances based on approach grades, a Design Waiver shall be requested in accordance with [IIM-LD-227](#), see 2011 AASHTO Green Book, Chapter 9, Section 9.5.3, page 9-32 for further guidance. Design Waiver and Design Exception requirements are based on the following;

- 1) Design Waiver – Meets Stopping Sight Distance but not Intersection Stopping Sight Distance.
- 2) Design Exception – Does not meet the minimum Stopping Sight Distance (See Chapter 2D).

The Intersection Sight Distance values in the table above permit a vehicle stopped on a minor road or median crossover, to cross the major road safely or merge safely in the case of turns.

The Intersection Sight Distance table above is based on the following criteria:

The AASHTO Green Book shows that it requires 7.5 seconds for a passenger car to turn left onto a two-lane road. For a passenger vehicle to turn right into the first lane, the Green Book shows that only 6.5 seconds is required because drivers making right turns generally accept gaps that slightly shorter than those accepted in making left turns.

The reference to 18' median in Table 2-5 applies to medians up to 18' in width (18' or less). For medians up to this width there is not sufficient room to stop so more sight distance is needed. For wider medians, there would be room to stop in the middle of the highway so sight distance can be less.

* Rev. 1/17

STOPPING SIGHT DISTANCE

Stopping sight distances exceeding those shown in the table below should be used as basis for design wherever practical.*

In computing and measuring stopping sight distances, the height of the driver's eye is estimated to be 3.5 feet and the height of the object to be seen by the driver is 2 feet, equivalent to the taillight height of a passenger car. The "K Values" shown are a coefficient by which the algebraic difference in grade may be multiplied to determine the length in feet of the vertical curve that will provide minimum sight distance. Crest vertical curves shall meet or exceed AASHTO design criteria for Stopping Sight Distance, not the "k" Values. The "K" values for sag vertical curves take into account the headlight sight distance.

Height of Eye 3.5'						Height of Object 2'					
Design Speed (mph) **	25	30	35	40	45	50	55	60	65	70	75
Min. Sight Distance (ft.)	155	200	250	305	360	425	495	570	645	730	820
Minimum K Value For:											
Crest Vertical Curves	12	19	29	44	61	84	114	151	193	247	312
Sag Vertical Curves	26	37	49	64	79	96	115	136	157	181	206

Source: 2011 AASHTO Green Book, Chapter 3, Section 3.2.2, page 3-4

TABLE 2-6 STOPPING SIGHT DISTANCE

**For all tables, use design speed if available, if not use legal speed.

* Added 7/17

When a highway is on a grade, the sight distances in the table below shall be used. *

Design Speed (mph) **	Stopping Sight Distance on Grades					
	Downgrades			Upgrades		
	3%	6%	9%	3%	6%	9%
15	80	82	85	75	74	73
20	116	120	126	109	107	104
25	158	165	173	147	143	140
30	205	215	227	200	184	179
35	257	271	287	237	229	222
40	315	333	354	289	278	269
45	378	400	427	344	331	320
50	446	474	507	405	388	375
55	520	553	593	469	450	433
60	598	638	686	538	515	495
65	682	728	785	612	584	561
70	771	825	891	690	658	631
75	866	927	1003	772	736	704

TABLE 2-7 STOPPING SIGHT DISTANCE ON GRADES

(See 2011 AASHTO Green Book, Chapter 3, Section 3.2.2, page 3-5)

**For all tables, use design speed if available, if not use legal speed.

Connection grades are to provide for a smooth tie-in with the mainline edge of pavement in accordance with Appendix F, Section 2-INTERSECTING CROSS ROAD GRADES and are to provide for adequate sight distance.

Current practice is to eliminate scuppers on most bridge designs. For this reason a minimum gradient of 0.5 percent is desirable to facilitate surface run-off. There will be instances where flatter gradients are required, through vertical curves, long water crossings, etc.; therefore, the water should be removed by means of inlets in lieu of open scuppers. Gradients are to be computed to as few decimal places as possible and should be in numbers evenly divisible by four, where feasible.

All grades are to be checked, as accurately as possible at this stage. See GS standards or proper minimum vertical clearances at underpasses and overpasses.

Minimum vertical clearances for structures or limits of work at grade crossing of railroads are to be obtained from the Department of Rail and Public Transportation.

Drainage of the existing terrain and adequate cover for drainage structures are also important factors to be considered in designing grades.

Proposed grades for roadside ditches and/or special design ditches are to be shown on corresponding profile sheet. See [Chapter 7 of VDOT Drainage Manual](#).

* Added 7/17

Conflicts with utilities are to be avoided wherever practicable. See VDOT [Survey Manual, Chapter 8](#) for additional analysis information.*

The Department's permit policy allows vehicles with excess heights to operate on our highways under an over-height permit. In view of this, 14'-0" has been accepted as the maximum allowable height to be provided for during construction, reconstruction, or maintenance operations. Every effort must be made to insure that a minimum vertical clearance of 14'-2" is provided on existing grade separation structures during construction, reconstruction, or maintenance. If temporary reduction in the vertical clearance below 14'-2" is unavoidable and is apparent in the design stage, the Permit Office is to be advised when the project is turned in to the Construction Division.

The following information is to be furnished so that permit holders can be notified:

- Route, county, and mile post
- Name of railroad or route overpass
- Minimum overhead clearance prior to change
- Minimum overhead clearance after change

Date of change

Temporary or permanent

* Added 7/17

Median Crossovers

(With and Without Connections)

In commercial and industrial areas where property values are high and rights-of-way for wide medians are difficult to acquire, a paved flush traversable median 10' to 16' wide is the optimum design. The shape of the median end should generally be symmetrical when the median width is less than 10' and the median opening length is not excessive, but the bullet nose can be effectively used to reduce the opening. For a median width of 10' or more, the bullet nose design should be used instead of a semicircular design at 3-leg and 4-leg intersections.

The length of the median crossover and the shape of the median end are controlled by the width of the median and the turning radii. A wide median opening can be reduced at skewed intersections by utilizing modifications of the bullet nose design. Additional information may be obtained from the Access Spacing Table 2-2 and AASHTO's *A Policy on Geometric Design of Highways and Streets* (Median Openings).

New median crossovers must demonstrate that left-turn storage space is met. Use appropriate turning movement software for analysis (such as Auto-Turn).

Median Crossover Grades

On divided highways with depressed medians, there are generally three **cases*** by which superelevation is determined for the opposing traffic lanes.

One **case** is for the median pavement edges to be held at the same, or close to the same elevation. A second **case** is for each baseline elevation to be approximately the same, with a corresponding difference in elevation of the median pavement edges. The third **case** is for the superelevation of all lanes to be obtained along a single plane. Thus, the grade of the lane on the outside of the curve is higher than the inside lane. The various methods are illustrated below.

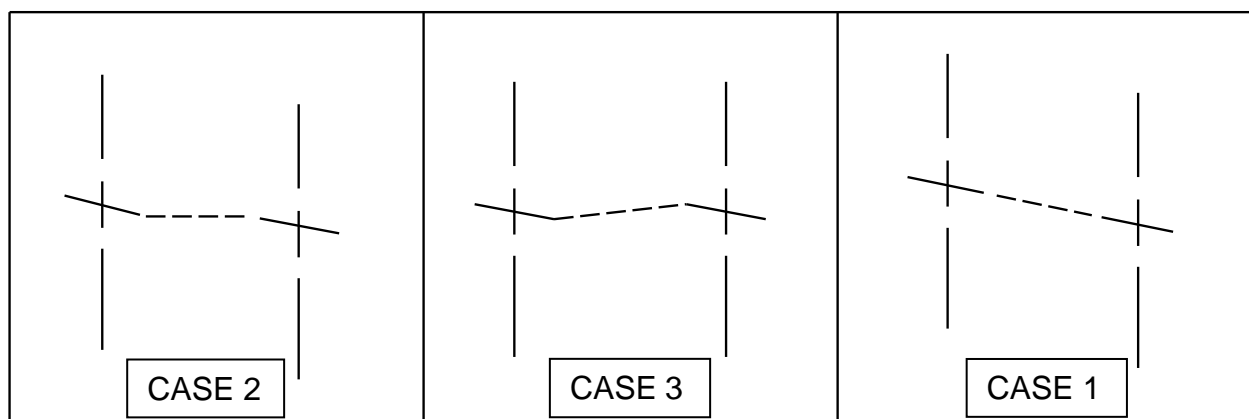

Source: AASHTO Green Book, Chapter 3, Section 3.3.8, Pages 3-80 and 3-81

* Rev. 7/15

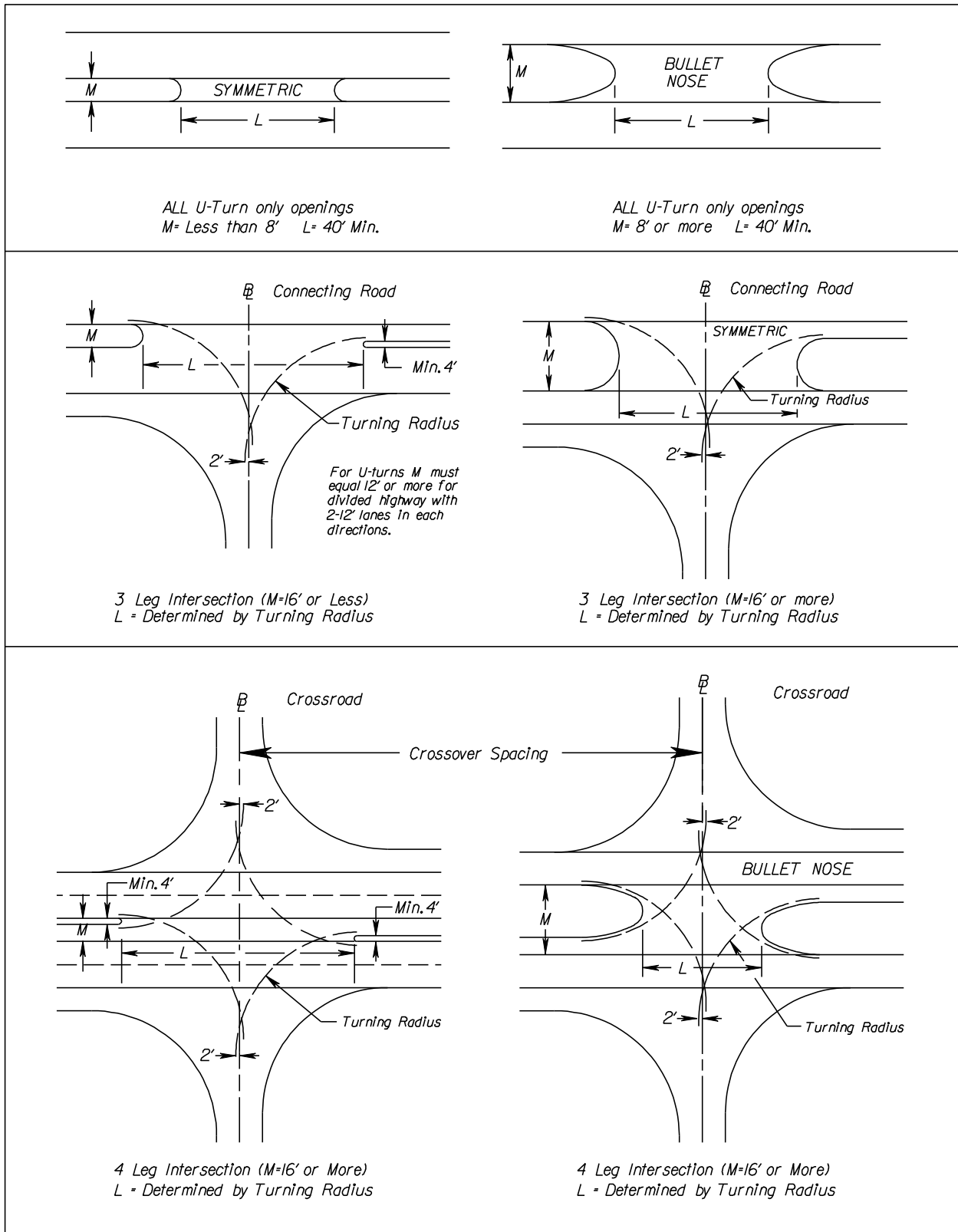

FIGURE 2-13 MEDIAN CROSSOVERS WITH AND WITHOUT CONNECTIONS*

* Rev. 1/14

The Engineer is to study the requirements of each particular situation. In the case of a facility without median crossovers, **Case 2*** above is generally acceptable on superelevated curves. This will allow the median area to be properly graded without creating an adverse design situation.

Case 3 generally results in an undesirable situation and must be used with caution.

In a case where a median crossover is proposed, particularly in conjunction with a connecting road within the limits of a superelevated curve, the designer shall pay particular attention to the path which must be traversed by vehicles using the median crossover.

In most cases, the application of the superelevation in a single plane (**Case 1**) is the acceptable method. This will allow a vehicle to cross from one lane to the other without negotiating several different gradients. As noted, herein, this will require the adjustment of the mainline grades.

The desirable grade on a median crossover is between 0.5% and 5%. The maximum grade should never exceed 10% as safe turning movements above this level are difficult. It is especially important at locations, such as truck stops and other businesses generating large vehicular traffic, that median crossover grades fall in the category of less than 5%. A desirable maximum algebraic difference of a median crossover crown line is 4 or 5 percent, but it may be as high as 8 percent at the locations where there are few trucks or school buses and low speeds.

Additionally, sight distances must be checked for values shown in the Table 2-5 Intersection Sight Distance.

Any deviation from these values is to be brought to the attention of the State Location and Design Engineer.

The grade on a median crossover is measured from the edge of shoulder to the edge of shoulder, unless left turn lanes are provided, in which case the grade is applied from the edge of pavement of the left turn lanes to the edge of pavement of the opposite left turn lane. This is more clearly shown in the following diagram:

Determination of Grade on a Crossover



In preparing plans for field inspection, the gradient at each median crossover is to be plotted graphically.

* Rev. 7/15

Intersecting Cross Road Grades

The grade of a connecting facility must be carefully studied when approaching an intersection where the mainline is superelevated. A smooth grade tie-in is desirable, with sufficient area on a relatively flat grade for a vehicle to stop before entering the main roadway. Also, when a connection is on the outside of a superelevated curve, the grade must be designed so that the connection is visible to a driver on the main roadway desiring to turn onto the connections.

Every attempt must be made to provide an adequate area for this vehicular stoppage, giving full consideration to the horizontal and vertical sight distances.

The desirable tie-in is one that is no steeper than the pavement cross slope whether this is superelevated or the normal crown. The maximum difference between the pavement cross slope and the approach road grade shall not exceed 8% at stop intersections or 4% at continuous-movement intersections. The stoppage area should be a minimum of 50' before beginning the steeper grade. (See AASHTO's *A Policy on Geometric Design of Highways and Streets*).

Innovative Intersection and Interchange Policies*

Roundabout Policy

VDOT recognizes that roundabouts are frequently able to address safety and operational objectives better than other types of intersections in both urban and rural environments and on high-speed and low-speed highways.

Therefore, it is VDOT policy that roundabouts be considered when a project includes reconstructing or constructing new intersection(s), signalized or unsignalized (HJR 594, 2003). As a minimum, the roundabout alternative shall be reviewed to determine conceptual project impacts including safety, land impacts and construction. If the roundabout appears to be a feasible alternative, then a traffic analysis and preliminary layout should be developed and analyzed in more detail. In such case the Engineer shall provide an analysis of each intersection to determine if a roundabout is a feasible alternative based on site constraints, including right-of-way, environmental factors and other design constraints. The advantages and disadvantages of constructing a roundabout shall be documented for each intersection.

The Department's **Roundabout Analysis Selection Tools** listed below shall be used to determine if a roundabout is a feasible alternative.

- [1-Roundabout Screening Criteria](#)
- [2-Roundabout Cost Comparison Tool Manual v2.5](#)
- [3-Roundabout Cost Comparison Tool v2.5](#)
- [4-Roundabout Design Guidance](#)

* Rev. 7/17

When the analysis shows that a roundabout is a feasible alternative, it is considered the Department's preferred alternative due to the proven substantial safety and operational benefits.

Innovative Intersection and Interchange Policy*

VDOT recognizes that conventional intersections are not always the most effective traffic control and Innovative Intersections/interchanges, including but not limited to roundabouts, can provide innovative solutions to address safety and operational objectives better in both urban and rural environments and on both high-speed and low-speed highways. Innovative Intersections are defined as non-traditional intersection designs that improve operations and safety by reducing the overall number of conflicting movements and/or signal phases.

Therefore, it is VDOT's Innovative Intersection and Interchange policy that:

- On Mobility Preservation Segments (MPS) and Mobility Enhancement Segments (MES) [Mapping of which can be found at this hyperlink: <http://vdot.maps.arcgis.com/apps/webappviewer/index.html?id=8cf10ec607844f75be916e27b15f43eb>], Innovative Intersections, including roundabouts, **shall** be considered when a project involves constructing or reconstructing any new intersection. Reconstruction includes signalization of an unsignalized intersection.
- On both MPS and MES portions of the Corridors of Statewide Significance (CoSS) and the National Highway System that are not part of the CoSS, roundabouts **shall** be considered and other Innovative Intersection designs **should** be considered when a project involves constructing or reconstructing any new intersection.
- Innovative Intersection designs **shall** be considered prior to the construction of a new grade-separated interchange as a replacement for an existing at-grade intersection.
- For projects involving new freeway interchanges or reconstruction of existing freeway interchanges, Innovative Interchange configurations **shall** be considered.

This is reinforced by [The Virginia Supplement to the MUTCD](#), which has specific restrictions requiring the necessary engineering evaluations that shall be performed prior to installation of new traffic signals on the CoSS. Also note that all new traffic signals on MPHSS shall be approved by the VDOT State Traffic Engineer as per IIM-TE-387.0

* Rev. 7/17

Innovative Intersection and interchange controls shall be analyzed to determine benefits and impacts including safety, delay reduction, right-of-way and environmental impacts. During the preliminary engineering phase, it is not necessary to consider all Innovative Intersection/interchange configurations; engineering judgment should be used to identify which configurations are potentially applicable.*

The Department's VDOT Junction Screening Tool (VJuST) will be used to determine which Innovative Intersection/interchange control configurations are most deserving of further investigation at a particular location. Those configurations deserving further investigation will then be analyzed more comprehensively in accordance with TOSAM. A Preliminary layout and construction cost for each feasible alternative shall be developed and the advantages and disadvantages of constructing each of the feasible alternatives shall be documented for each alternative analyzed.

The District Traffic Engineer shall then provide a recommendation to the Innovative Intersection Review Committee as to the preferred Innovative Intersection/interchange for the location, based on safety, operational, environmental, right of way and/or Common Sense Engineering benefits, for their concurrence.

Below are examples of Innovative Intersection and Interchange Control Types that VDOT currently recognizes as effective traffic control treatments:

Intersections

- Displaced Left-Turn (DLT)
- Median U-Turn (MUT)
- Restricted Crossing U-Turn (RCUT)
- Continuous Green-T (CGT)
- Quadrant Roadway (QR)
- Jug-handle
- Roundabouts

Interchanges

- Diverging Diamond Interchange (DDI)
- Single Point Urban Interchange
- Double Roundabout Interchange

* Added. 7/17

For Details of these Innovative Intersections and interchanges, including roundabouts, see Appendix A-3 of this Manual.

Other Innovative Intersection and interchange designs may be developed in the future and will be listed in Appendix A-3 of this Manual.

For more information on the above mentioned Innovative Intersection Designs see:
http://www.virginiadot.org/info/alternative_intersection_informational_design_guides.asp
https://safety.fhwa.dot.gov/intersection/alter_design/*

Accommodating Pedestrians and Bicyclists

According to the Commonwealth Transportation Board's adopted *Policy for Integrating Bicycle and Pedestrian Accommodations*, bicycling and walking are fundamental travel modes and integral components of an efficient transportation network. Appropriate bicycle and pedestrian accommodations provide the public, including the disabled community, with

- Access to the transportation network;
- Connectivity with other modes of transportation; and
- Independent mobility regardless of age, physical constraints, or income.

Effective bicycle and pedestrian accommodations enhance the quality of life and health, strengthen communities, increase safety for all highway users, reduce congestion, and can benefit the environment. Bicycling and walking are successfully accommodated when travel by these modes is efficient, safe, and comfortable for the public. It is important that the consideration and provision of bicycling and walking accommodations be consistently incorporated into the decision-making process for Virginia's transportation network.

The VDOT web site contains a number of resources on accommodating pedestrian and bicycle facilities as well as facility design guidelines.

VDOT's [Designated Bicycle and Pedestrian Accommodations](#) provides design standards for bicycle and pedestrian facilities (e.g. designated bicycle lanes at least 4 feet in width, providing striping for bicycle lanes, asphalt or concrete sidewalks at least 5 feet in width, pedestrian islands at intersections and roundabouts).

Bicycle and Pedestrian Facility Guidelines are presented in [Appendix A\(1\)](#), [Section A\(1\)-1*](#) of the *Road Design Manual*. For information on curb ramps and sidewalks, see [IIM-LD-55](#). Also see [MUTCD](#), Chapter 9, Traffic Control for Bicycle Facilities

[Standards for Intersection Crosswalk Markings](#) can be found on page 3B-27 in the [Manual for Uniform Traffic Control Devices](#) and [Standards for Pedestrian and Bicycle Markings for Roundabouts](#) are described on pages 3B-44 and 3B-45.

Figure 3-25 offers a basic illustration of these pedestrian and bicycle concepts along a highway corridor and at an intersection.

An Internal Bicycle and Pedestrian Task Force is responsible for ensuring consistent implementation of bicycle and pedestrian policies within VDOT, while the Bicycle Accommodations Review Team evaluates proposed plans to ensure consistency in bicycle and pedestrian facility design. For additional information see the [State Bicycle and Pedestrian Program](#) web page on the VDOT web site.

Managing Access to the Highway and Pedestrian/Bicyclist Safety

Numerous entrances and intersections create safety problems for pedestrians and bicyclists. Every entrance and intersection creates pedestrian-vehicle, bicyclist-vehicle and vehicle-vehicle conflicts. Pedestrians and bicyclists are especially vulnerable to vehicular left turns because they are small visual objects compared to vehicles and not clearly visible to drivers who are focusing on the opposing traffic when they begin a left turn. Left turns account for a high number of crashes with bicyclists and pedestrians.

Reducing the number of entrances and limiting access from one or more directions improves pedestrian and bicyclist safety:

- The number of conflict locations is minimized;
- Lowering the driver workload, as well as that of pedestrians and bicyclists, improves safety and simultaneously improves traffic flow.
- Pedestrian/bicyclist crossing is enhanced with median refuge areas; and
- Accommodating the disabled is easier, as the need for special treatments at entrances is reduced.

Figure 2-15 below illustrates how each entrance creates eight potential conflict points for pedestrians and bicyclists. Reducing the number of entrances and restricting left turn movements lowers these potential crash points.

* Rev. 7/18

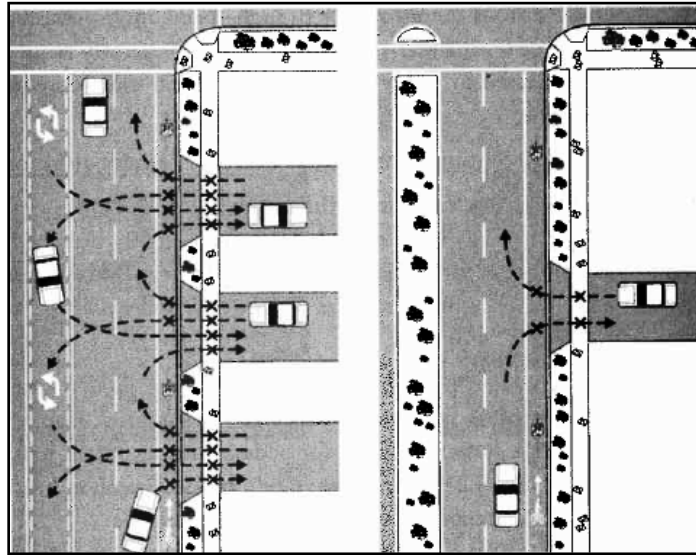

FIGURE 2-23 REDUCING THE NUMBER OF ENTRANCES BENEFITS PEDESTRIANS AND BICYCLISTS

Source: *Transportation & Land Development 2nd Edition 2003*, Koepke and Stover

Once the pattern of entrances and intersections is established, it is difficult to retroactively reduce, consolidate, or eliminate existing entrances to make existing roads more attractive to bicyclists and pedestrians.

However, mid-block crosswalks can be considered to provide locations for pedestrians and bicyclists to cross arterials between intersections where pedestrian/bicyclist attractors are located on opposite sides of a roadway. Mid-block crossings can provide:

- Visual cues to allow approaching motorists to anticipate pedestrian activity and unexpected stopped vehicles, and
- Reasonable opportunities to cross during heavy traffic periods, when there are few natural gaps in the traffic streams.

A traffic engineering investigation study will need to evaluate the proposed location and design. Conditions to examine include: sight distance, speeds, volumes, crash experiences, illumination, number and type of pedestrians, and the location of pedestrian generators. Design considerations include median refuge area, pavement markings, advance warning signs for vehicular traffic, and coordinating potential pedestrian/bicyclist activated crossing signals with the traffic signal timing on the highway so as to not interfere with traffic progression.

The Federal Highway Administration's web site contains a variety of research reports on techniques for improving pedestrian and bicyclist safety along the highway:

<http://www.fhrc.gov/safety/pab.htm>.

References for Section 2: Intersections

1. "Highway Capacity Manual" Special Report 209, Transportation Research Board, National Research Council, Washington, D.C. (2000).
2. Manual of Uniform Traffic Control Devices for Streets and Highways, Federal Highway Administration, Washington, D.C. (2003).
3. Levinson, H.S. "The Capacity of Shared Left Turn Lanes" Transportation Research Record 1225. Transportation Research Board, National Research Council, Washington, D.C. (1989).
4. Roundabouts: An Informational Guide, Federal Highway Administration, Washington D.C. (2000).
5. Stover, V.G. and Koepke, F., Transportation and Land Development, Institute of Transportation Engineers, Washington, D.C. (2002).

SECTION 3 – TURNING LANES

Turn Lane Criteria for Single and Dual Lanes

Right and left-turn lanes shall be provided for traffic in both directions in the design of intersections and left turn lanes for median crossovers and in one direction for directional median openings (see Figure 3-25 illustration) on non-access controlled four-lane or greater divided highways using the criteria as shown in Figure 3-1 and adjusted upward as determined by Figure 3-3 or by capacity analysis for left-turn storage.

Left-turn lanes shall also be established on two-lane and four lane highways where needed for storage of left-turn vehicles and/or prevention of thru-traffic delay using the criteria shown in Figure 3-1. See Table 3-1 and Figures 3-5 through 3-22 for warrants for left-turn storage lanes on two-lane highways and Figure 3-3 for four-lane highways.

Intersections with low right turn volumes shall be evaluated in accordance with Figures 3-26 and 3-27.

LENGTH OF STORAGE (*)		TAPER - Rural (*)	
Rural - For Design Speeds 50 MPH or Higher	*L - 200' min. (For 240 or fewer vehicles during peak hour, making turn)	- For Design Speeds 35 MPH or Higher	**T - 200' Min.
Rural - For Design Speeds 45 MPH or Less	*L - 100' min. (For 60 or fewer vehicles during peak hour, making turn)	- For Design Speeds 30 MPH or Less	**T - 100' Min. (single) **T - 200' Min. (dual)
*Distance L to be adjusted upward as determined by capacity analysis for Left and Right Turn Storage.		**Tapers are to be straight-line unless local policy requires reverse curves. In congested areas the taper length may be reduced to increase storage length. However, a design waiver shall be required.	
LENGTH OF STORAGE		TAPER - Urban	
Urban - Length determined by capacity analysis for Left and Right Turn Storage (100' Minimum)		- For Design Speeds 50 MPH or Higher	**T - 200' Min.
		- For Design Speeds 45 MPH or Less	**T - 100' Min. (single) **T - 150' Min. (dual)

(*) For instructions on selection of design speed, see [Appendix A, Section A-1](#)

FIGURE 3-1 RIGHT AND LEFT TURN LANE CRITERIA FOR SINGLE AND DUAL LANES

Taper rates: Rural - 8:1 for design speeds 30 mph and less, 15:1 for design speeds 35 mph and greater. Urban - 8:1 for design speeds 45 mph and less, 15:1 for design speeds 50 mph and greater. For urban dual lane taper (150' min.), See 2011 AASHTO Green Book, Chapter 9, Section 9.7.1, page 9-127.

Note: Taper lengths shown above were compiled using these formulas and were rounded up.

For Four-Lane Highways

*Storage Length "S" to be adjusted upward as determined by Figure 3-3 or by capacity analysis for left-turn storage lanes on four-lane or greater highways.

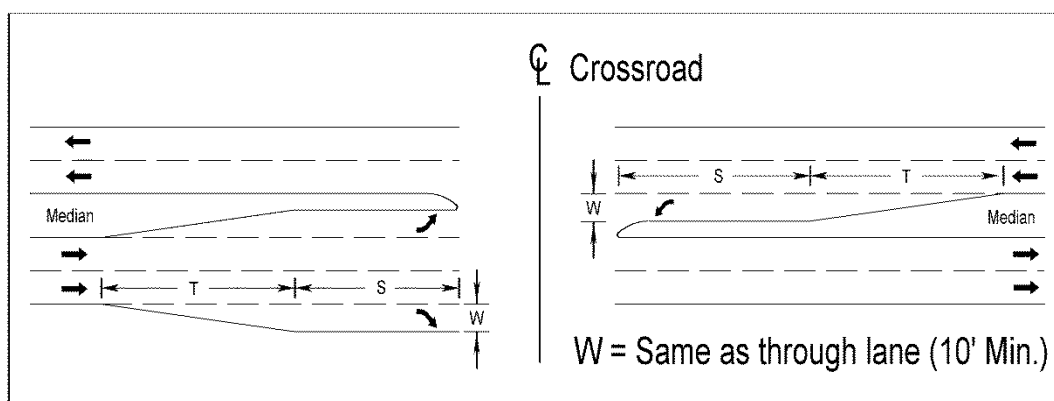

FIGURE 3-2 LEFT AND RIGHT TURN STORAGE AND TAPER LENGTHS

Warrants for Left Turn Storage Lanes on Four-Lane Highways

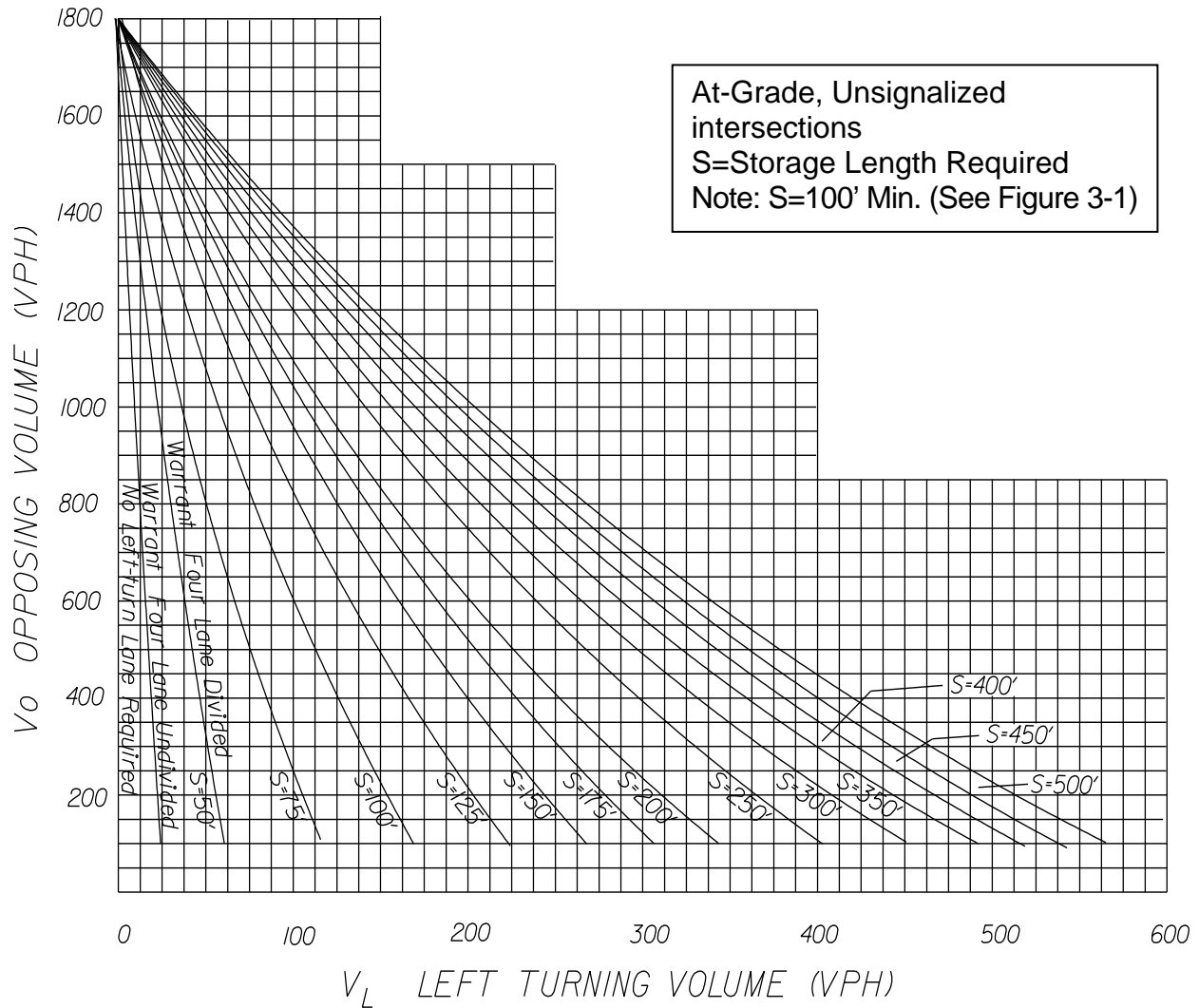

FIGURE 3-3 WARRANTS FOR LEFT TURN STORAGE LANES ON FOUR-LANE HIGHWAYS

Figure 3-3 was derived from Highway Research Report No. 211.

Opposing volume and left turning volume in vehicles per hour (VPH) are used for left turn storage lane warrants on four-lane highways.

For plan detail requirements when curb and/or gutter are used, see VDOT's Road Design Manual, [Section 2E-3](#) on the VDOT web site:

<http://www.virginiadot.org/business/locdes/rdmanual-index.asp>.

For Two-lane Highways

Storage Length "S" to be adjusted upward as determined by Table 3-1 and Figures 3-5 through 3-22 or by a capacity analysis for left-turn storage. A capacity analysis is defined as a detailed analysis of the location in accordance with the guidelines contained in the current issue of the *Highway Capacity Manual* for intersection capacity and signalization requirements.

In general, when left-turn volumes are higher than 100 VPH, an exclusive left-turn should be considered.

Dual left-turn lanes should be considered when left turn hourly volumes exceed 300 VPH.

Left-turn lanes shall also be established on two-lane highways where traffic volumes are high enough to warrant them.*

Warrants for Left Turn Storage Lanes on Two-Lane Highways

Advancing volume and opposing volumes (VPH), speed and percent left turns are used to determine whether a left turn storage lane is warranted on two-lane highways.

The warrants in table below are taken from the 2011 AASHTO Green Book, Chapter 9, Section 9.7.3, Page 9-132, Table 9-23. They were derived from Highway Research Report No. 211, Figures 2 through 19, for required storage length determinations.

* Rev. 7/18

WARRANTS FOR LEFT TURN LANES ON TWO-LANE HIGHWAYS

VPH OPPOSING VOLUME	ADVANCING VOLUME			
	5% LEFT TURNS	10% LEFT TURNS	20% LEFT TURNS	30% LEFT TURNS
40-MPH DESIGN SPEED*				
800	330	240	180	160
600	410	305	225	200
400	510	380	275	245
200	640	470	350	305
100	720	515	390	340
50-MPH DESIGN SPEED*				
800	280	210	165	135
600	350	280	195	170
400	430	320	240	210
200	550	400	300	270
100	615	445	335	295
60-MPH DESIGN SPEED*				
800	230	170	125	115
600	290	210	160	140
400	365	270	200	175
200	450	330	250	215
100	505	370	275	240

TABLE 3-1

Source: Adapted from 2011 AASHTO Green Book, Chapter 9, Section 9.7.3, Page 9-132, Table 9-23

* USE DESIGN SPEED IF AVAILABLE, IF NOT USE LEGAL SPEED LIMIT.*

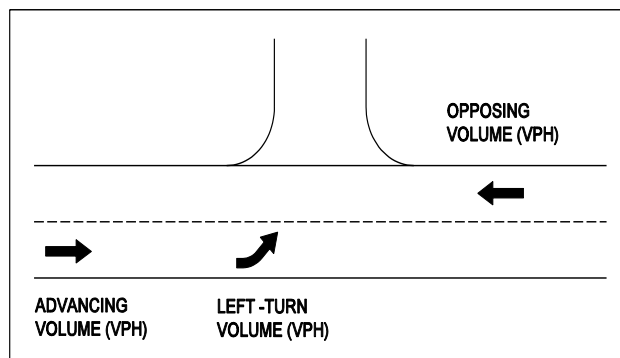

Example:

Two-lane highway with 40-MPH operating speed

Opposing Volume (VPH) - 600
 Advancing Volume (VPH) - 440
 Left-Turn Volume (VPH) - 44 or 10% of Advancing Volume

With opposing volume (VPH) of 600 and 10% of advancing volume (VPH) making left turns, and advancing volume (VPH) of 305 or more will warrant a left-turn lane.

When the Average Running Speed on an existing facility is available, the corresponding Design Speed may be obtained from [Appendix A, Section A-1](#).

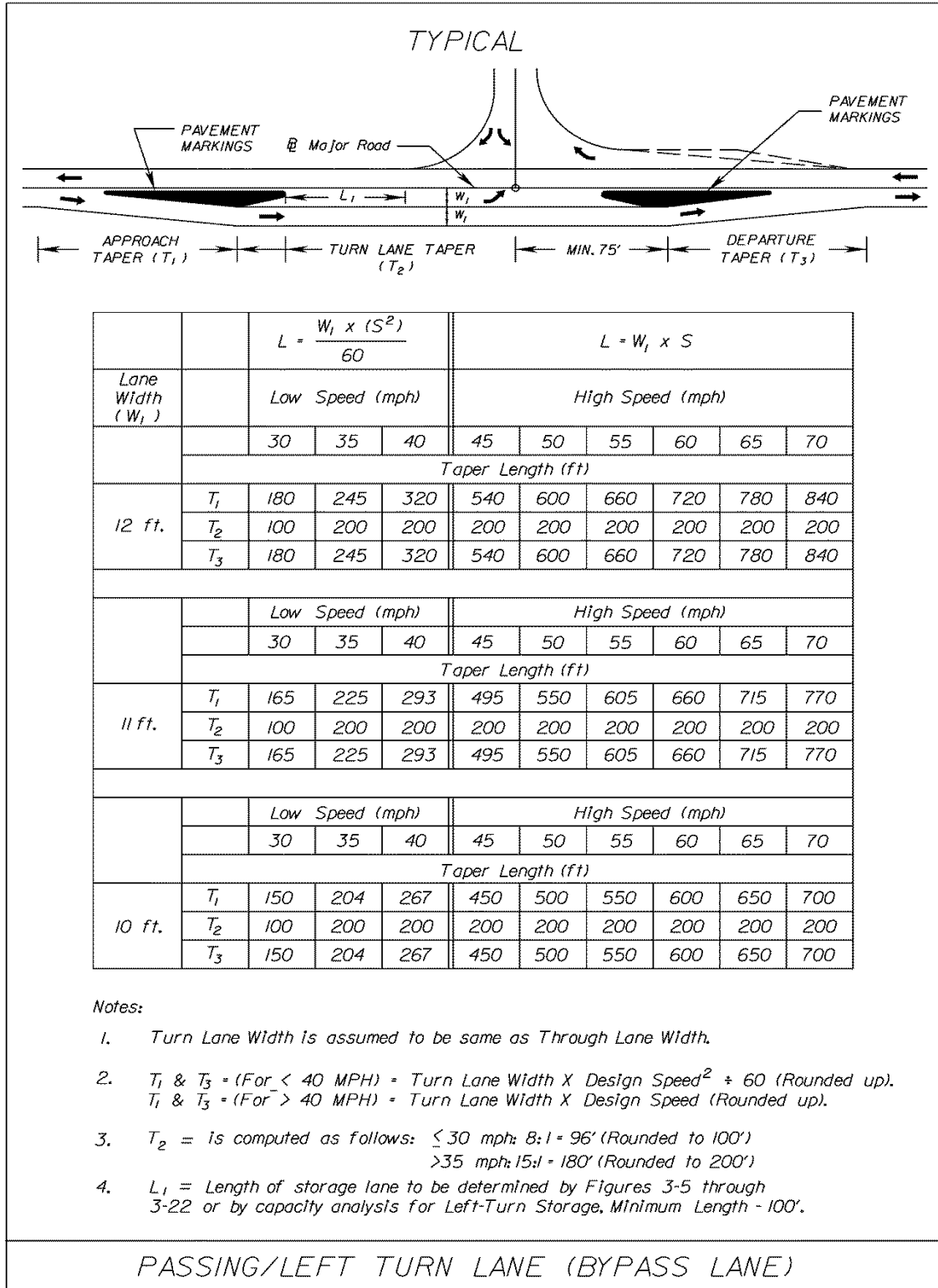

Notes:

1. Turn Lane Width is assumed to be same as Through Lane Width.
2. T₁ & T₃ = (For < 40 MPH) = Turn Lane Width X Design Speed² ÷ 60 (Rounded up).
T₁ & T₃ = (For > 40 MPH) = Turn Lane Width X Design Speed (Rounded up).
3. T₂ = is computed as follows: ≤ 30 mph: 8:1 = 96' (Rounded to 100')
>35 mph: 15:1 = 180' (Rounded to 200')
4. L₁ = Length of storage lane to be determined by Figures 3-5 through 3-22 or by capacity analysis for Left-Turn Storage, Minimum Length - 100'.

FIGURE 3-4 PASSING/LEFT TURN LANE

Sources: AASHTO Green Book, Chapter 3, Section 3.4.4, pages 3-132 to 3-138
NCHRP Report 780, page 17* © 2014

* Rev. 7/17

Figures 3-5 through 3-22 provide warrants for left-turn storage lanes on two-lane highways based on 5 to 30 percent left-turn volumes and design speeds of 40, 50, and 60 MPH. Additional storage length is required for 10 to 50 percent truck volumes.

NOTE: There are circumstances where a left turn lane may be needed even if the warrants are not met.

For example, intersections and entrances with poor visibility and/or a bad accident record may require the Engineer to use engineering judgment when volume conditions alone do not warrant a storage lane.

Additionally, the functional classification of the highway shall be considered so that the impact of turning movements on highways intended to serve through traffic is minimized.

Taper Lengths (L) - Lane/Pavement Transitions and Merging Tapers

Lane/pavement transitions and merging tapers typically occur where new or reconstructed roadways tie-in to existing roadways. Lane/pavement transitions and merging tapers shall meet the minimum length (L) provided by the following equations:

For 40 mph or less

$$L = S^2W \div 60$$

For 45 mph or greater

$$L = W \times S$$

L = length of transition

S = Design Speed

W = Width of offset on each side

Source: 2011 AASHTO Green Book, Page 3-134, Equations 3-37 & 3-38*

Pavement transition is separate from the length of need for guardrail. Length of need and shoulder prep for guardrail shall be in accordance with the VDOT RDM Appendix A and the [Road & Bridge Standards](#).

WARRANT FOR LEFT-TURN STORAGE LANES ON TWO-LANE HIGHWAY

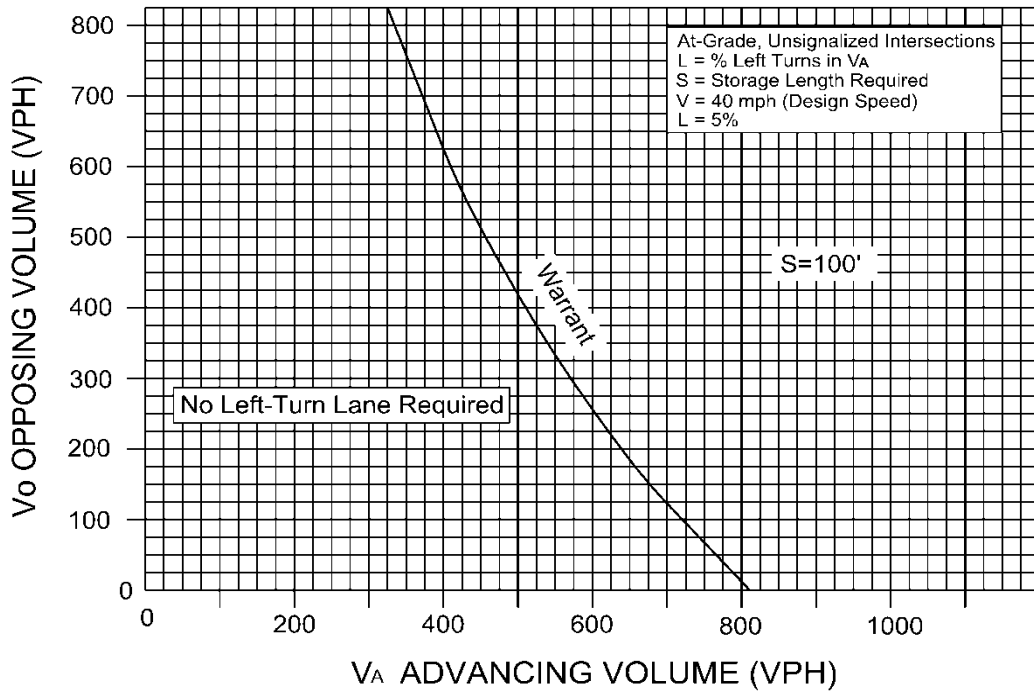

FIGURE 3-5

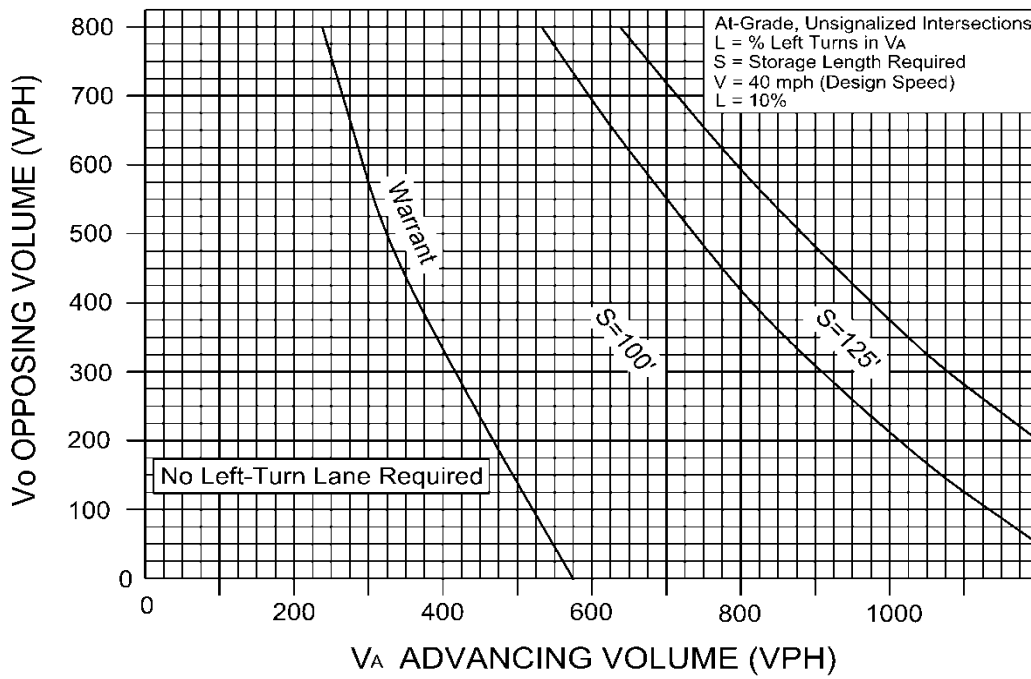

FIGURE 3-6

WARRANT FOR LEFT-TURN STORAGE LANES ON TWO-LANE HIGHWAY

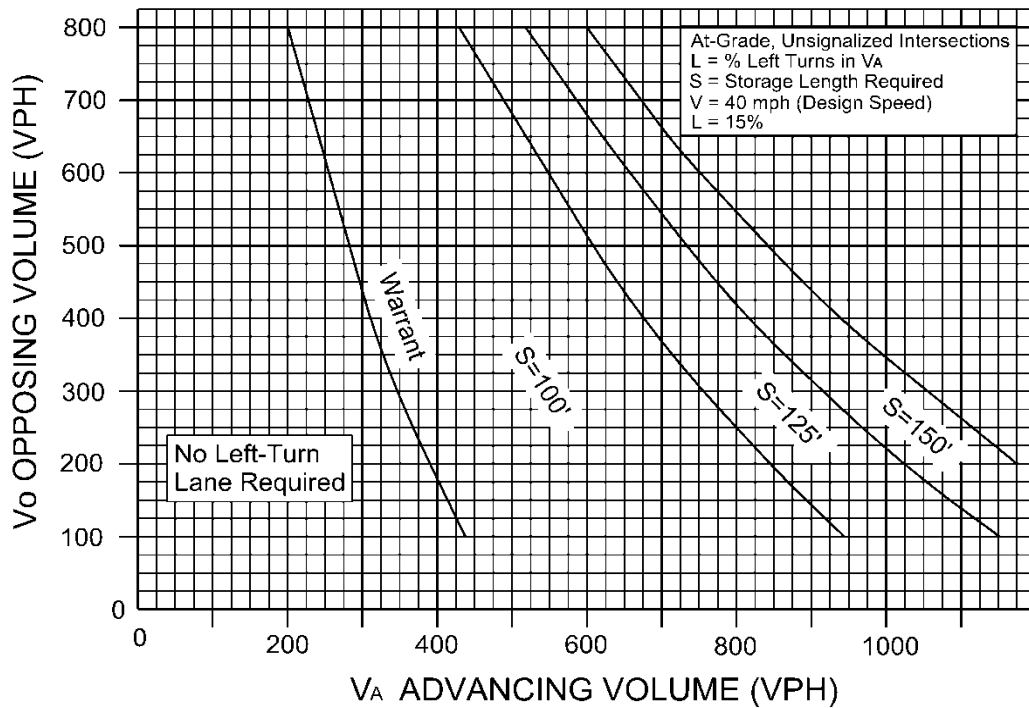

FIGURE 3-7

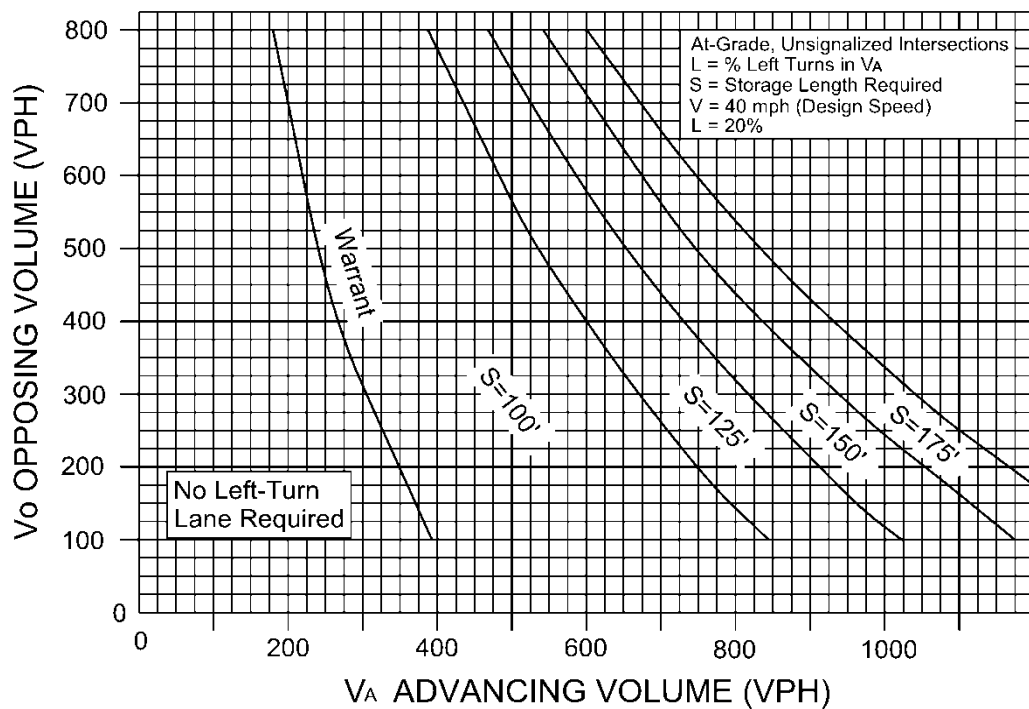

FIGURE 3-8

WARRANT FOR LEFT-TURN STORAGE LANES ON TWO-LANE HIGHWAY

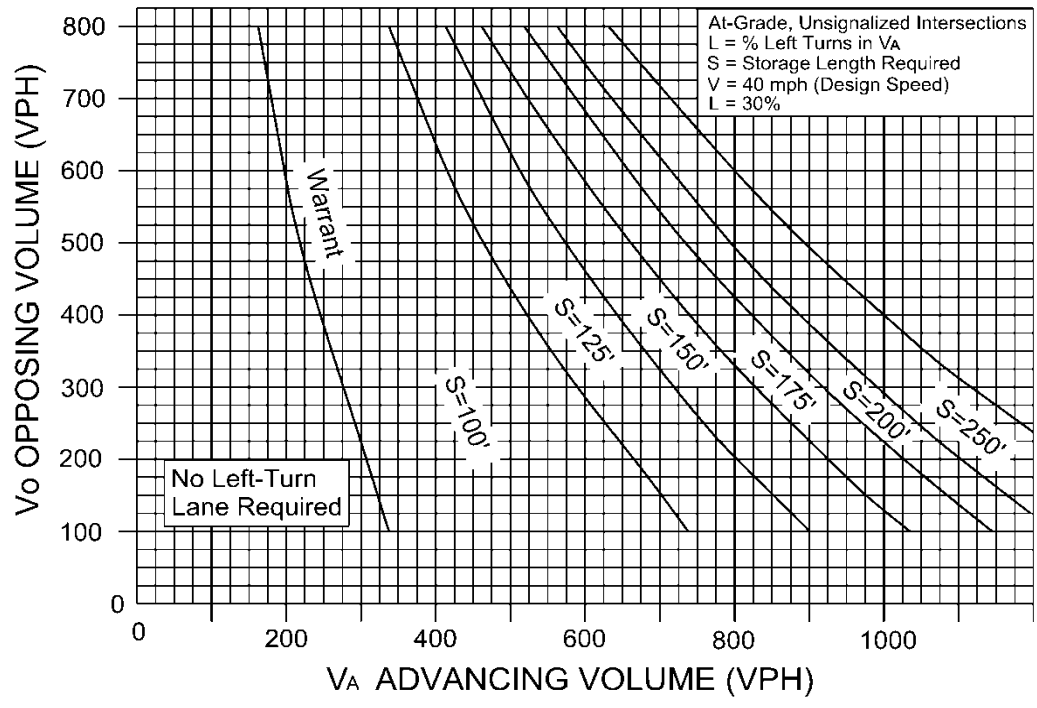

FIGURE 3-9

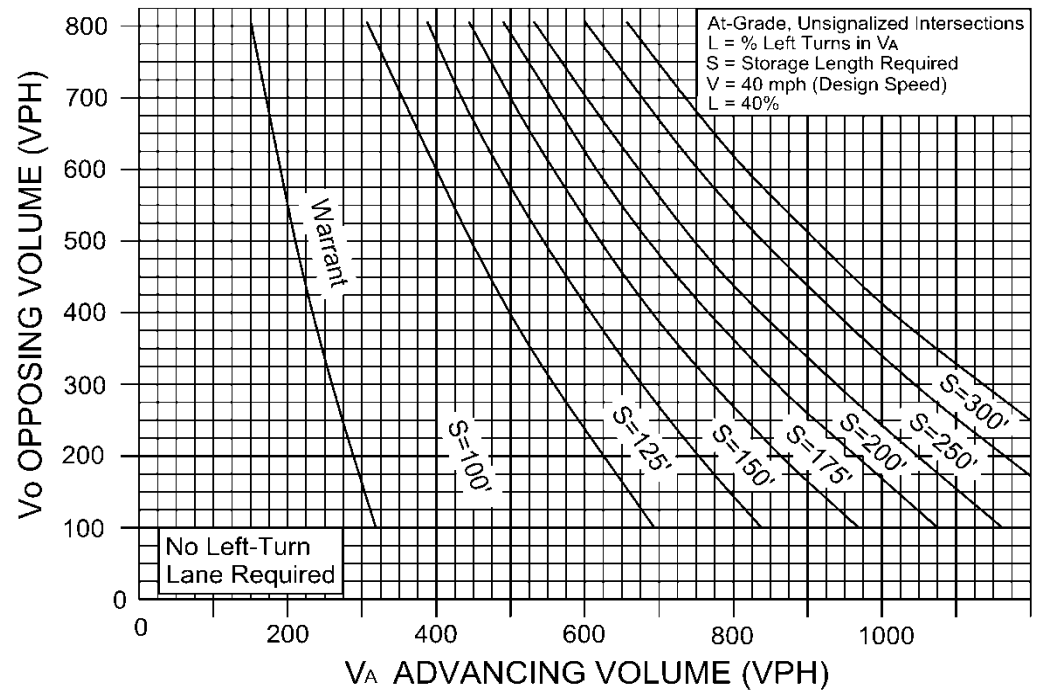

FIGURE 3-10

WARRANT FOR LEFT-TURN STORAGE LANES ON TWO-LANE HIGHWAY

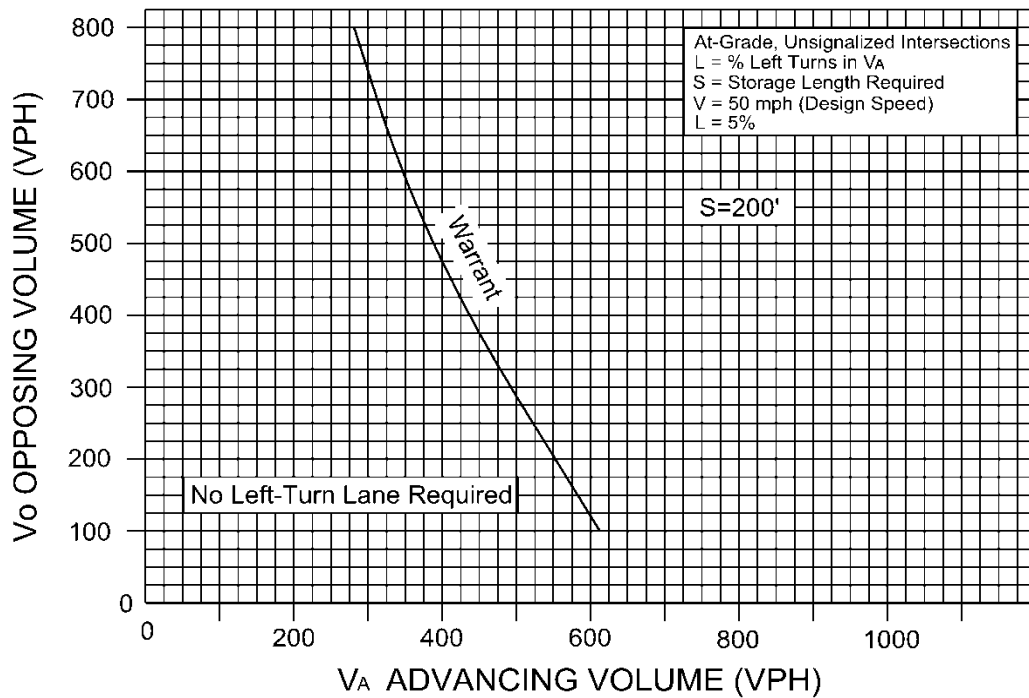

FIGURE 3-11

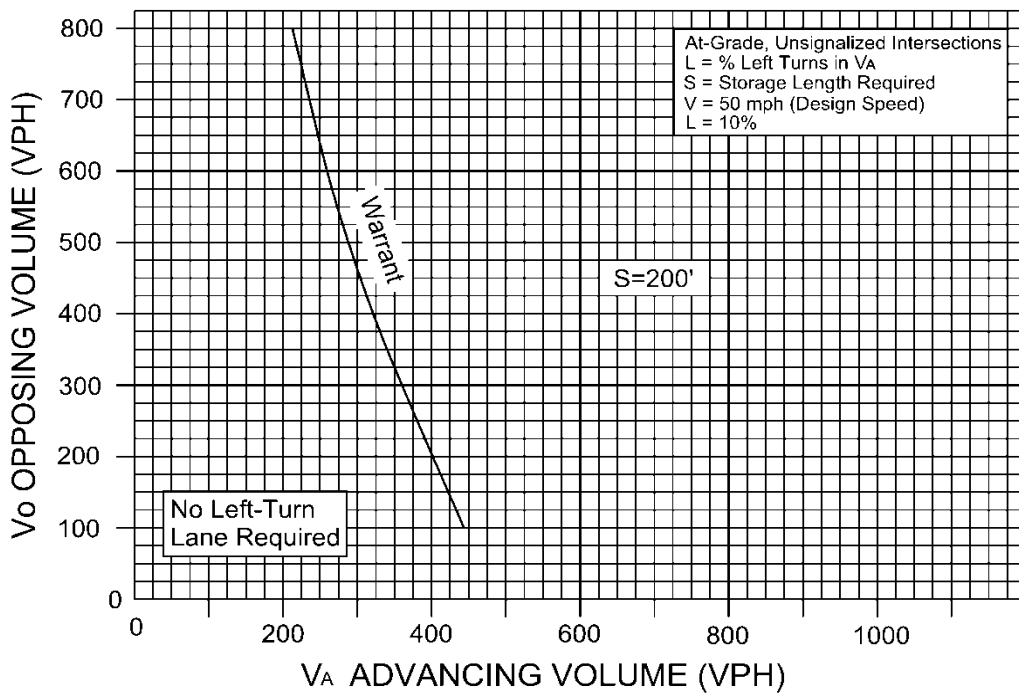

FIGURE 3-12

WARRANT FOR LEFT-TURN STORAGE LANES ON TWO-LANE HIGHWAY

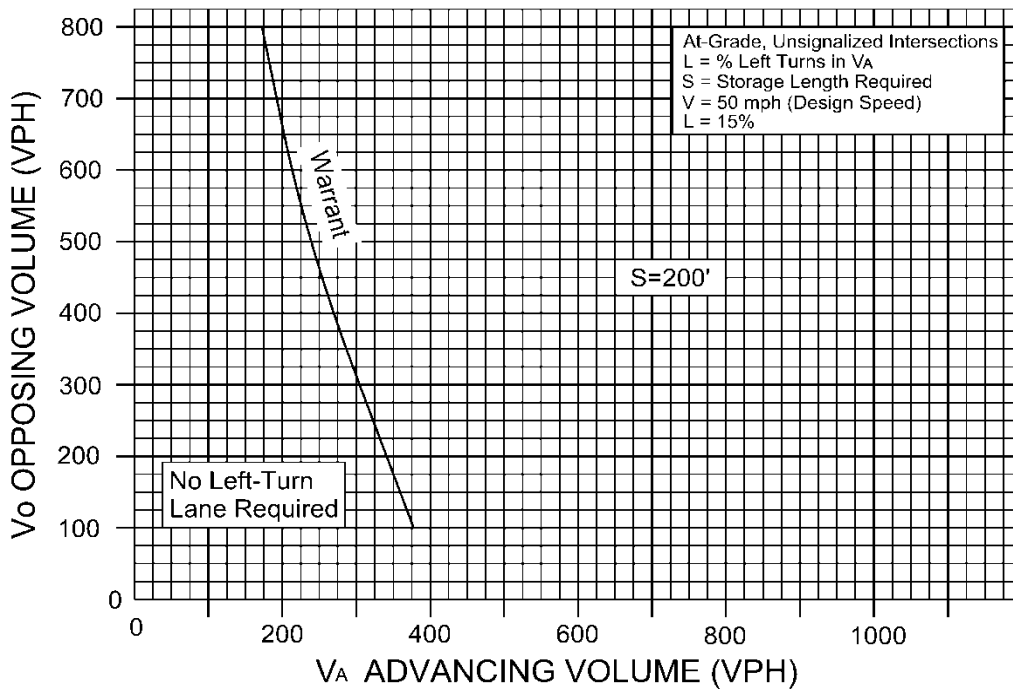

FIGURE 3-13

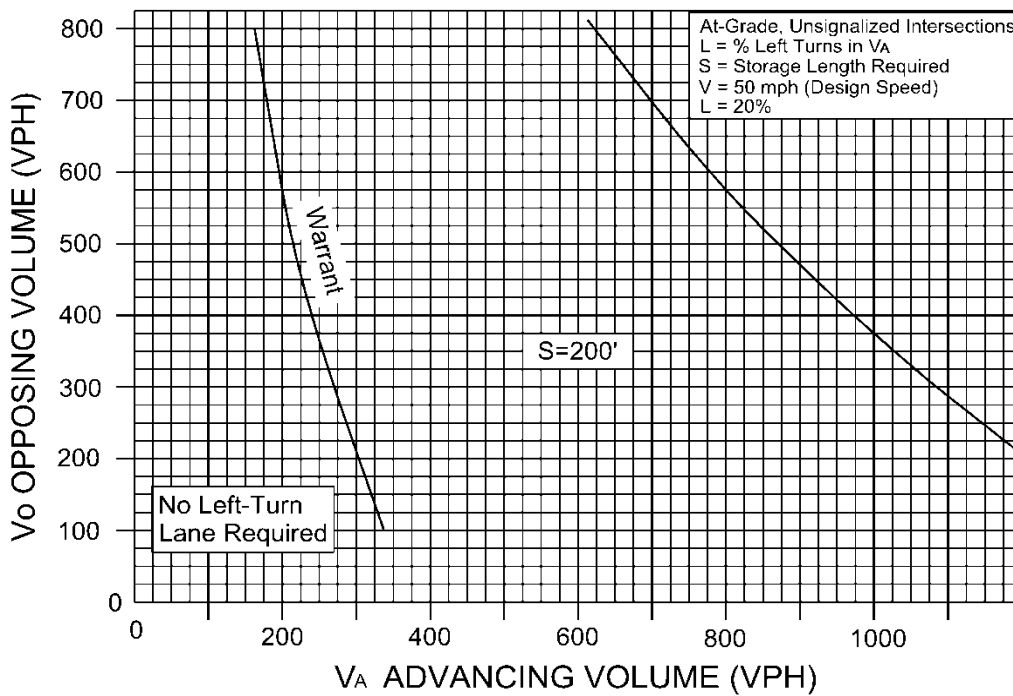

FIGURE 3-14

WARRANT FOR LEFT-TURN STORAGE LANES ON TWO-LANE HIGHWAY

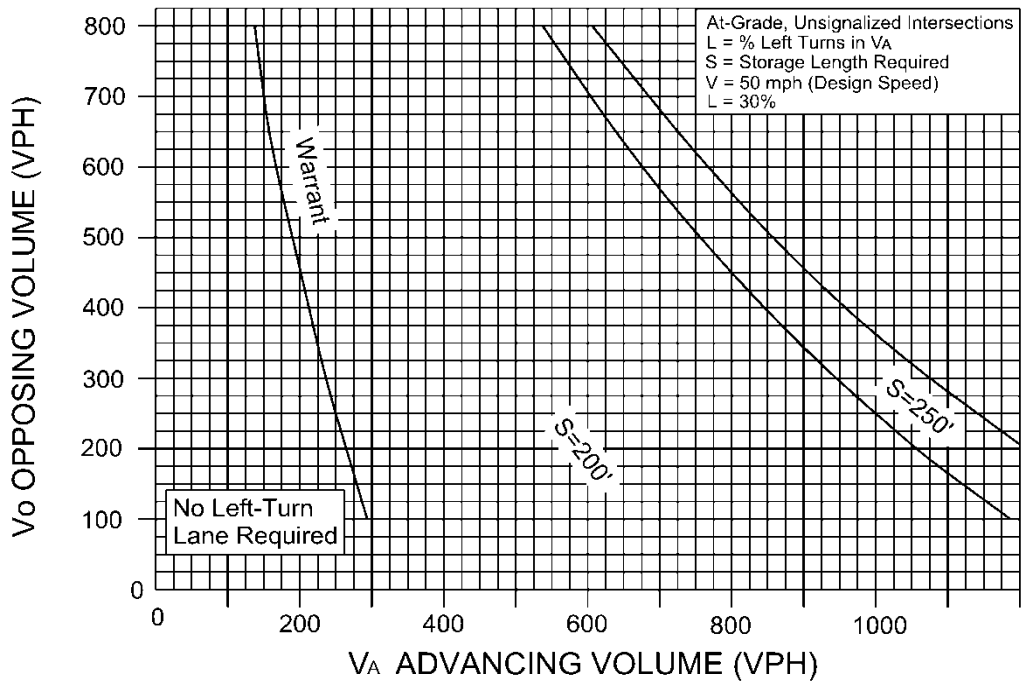

FIGURE 3-15

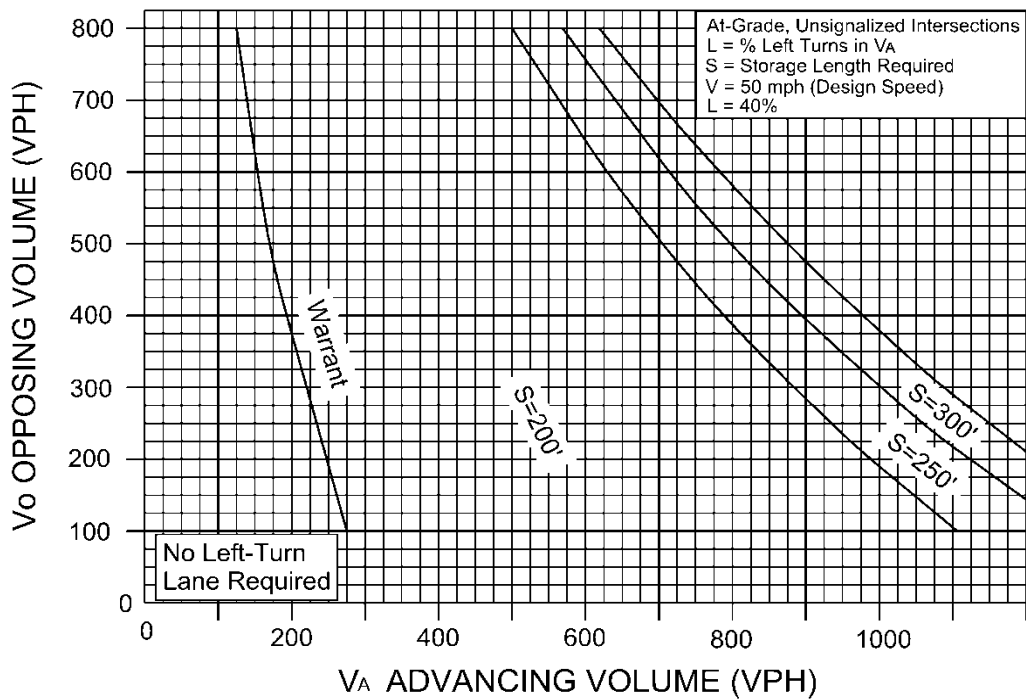

FIGURE 3-16

WARRANT FOR LEFT-TURN STORAGE LANES ON TWO-LANE HIGHWAY

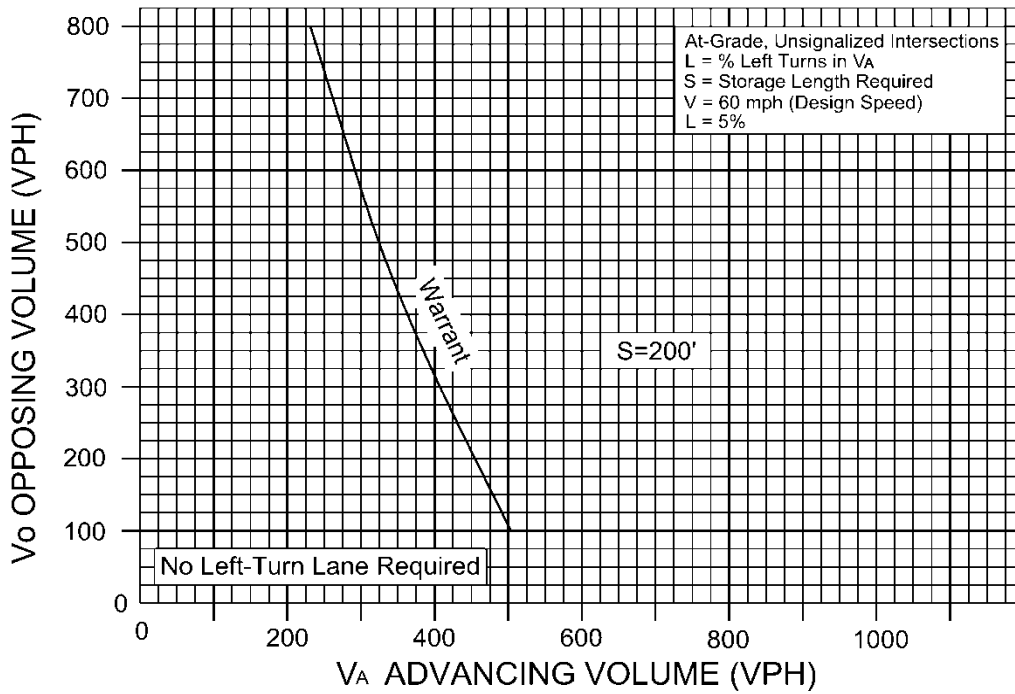

FIGURE 3-17

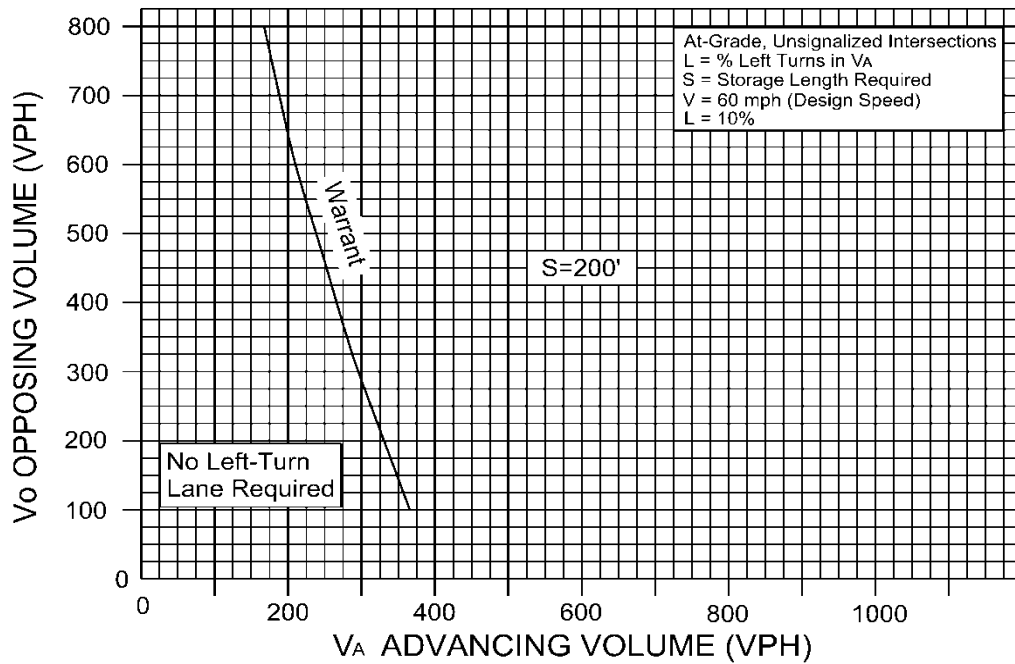

FIGURE 3-18

WARRANT FOR LEFT-TURN STORAGE LANES ON TWO-LANE HIGHWAY

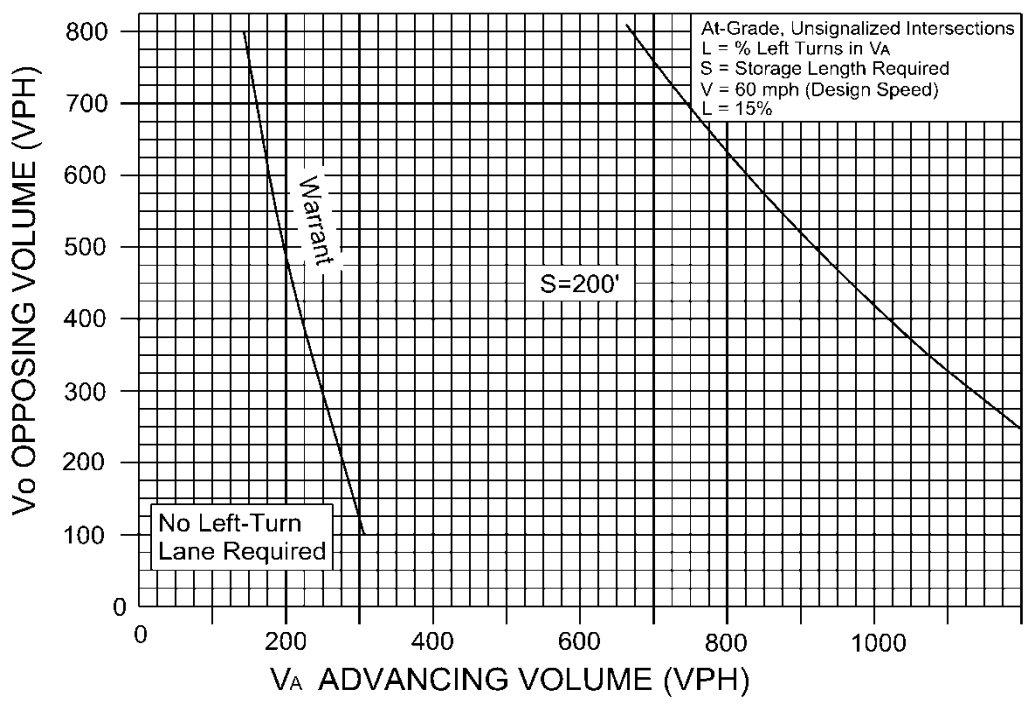

FIGURE 3-19

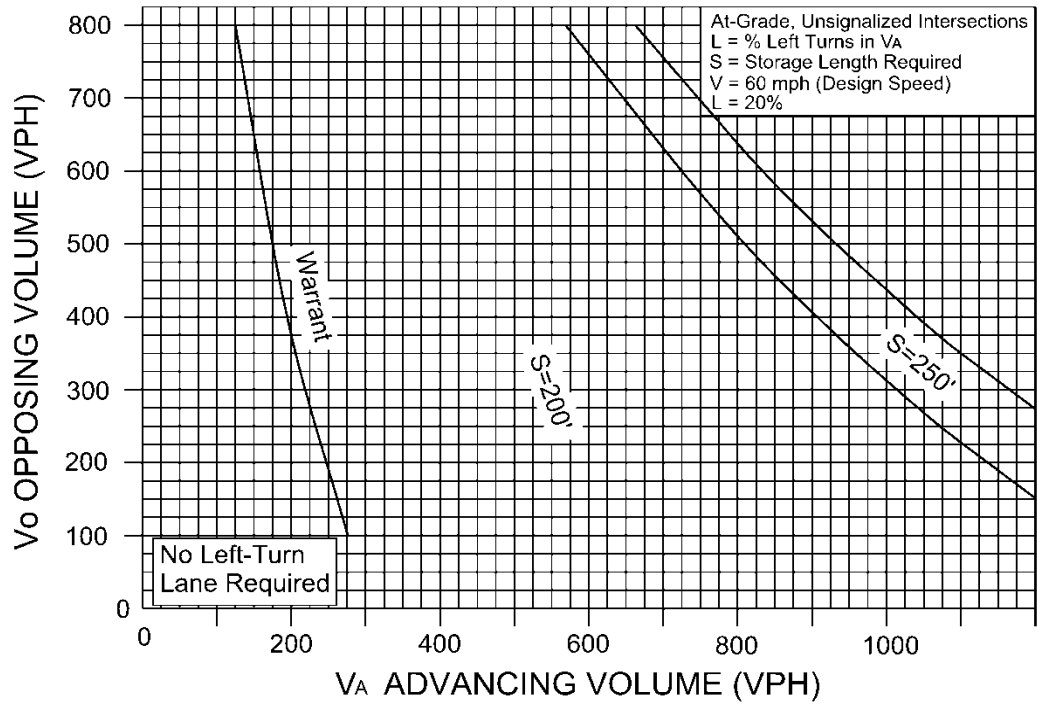

FIGURE 3-20

WARRANT FOR LEFT-TURN STORAGE LANES ON TWO-LANE HIGHWAY

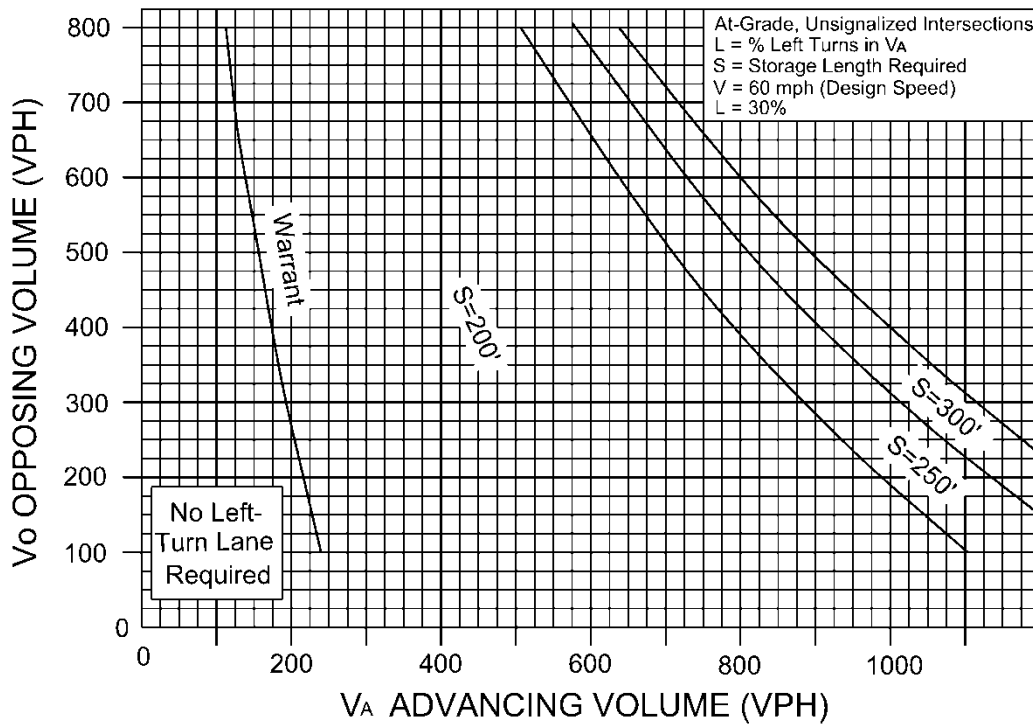

FIGURE 3-21

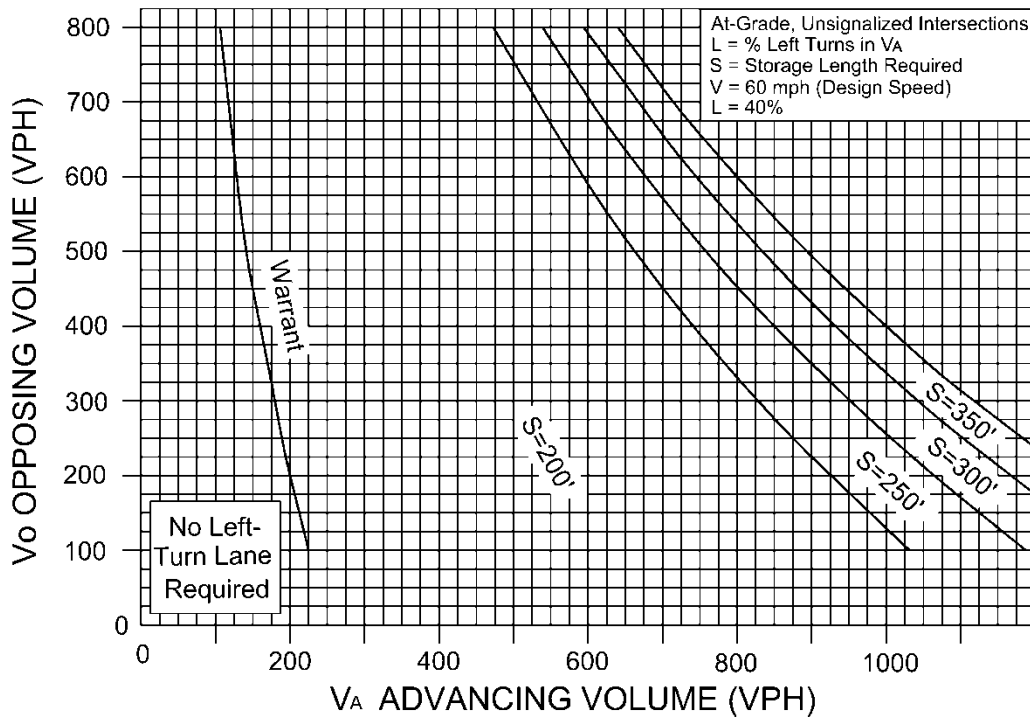

FIGURE 3-22

CHART VALUE OF STORAGE LANE REQUIRED	% TL=% TRUCKS IN VPH turning left					
	0%	10%	20%	30%	40%	50%
100'	0'	25'	25'	50'	50'	50'
125'	0'	25'	25'	50'	50'	75'
150'	0'	25'	50'	50'	75'	75'
175'	0'	25'	50'	75'	75'	100'
200'	0'	25'	50'	75'	100'	100'
250'	0'	25'	50'	75'	100'	125'
300'	0'	50'	75'	100'	125'	150'
350'	0'	50'	75'	125'	150'	175'
400'	0'	50'	100'	125'	175'	200'
450'	0'	50'	100'	150'	200'	225'
500'	0'	50'	100'	150'	200'	250'

TABLE 3-2 TRUCK ADJUSTMENTS

STORAGE LENGTH TO BE ADDED TO CHART VALUES OF LEFT-TURN LANE
STORAGE LENGTHS (Length in Feet)

Source: Highway Research Report Number 211*

Double (Dual) Left-Turn Lanes

Double (dual) left-turn lanes (DLTL's) shall be considered when left-turn demand exceeds 300 vph, and are desirable where peak left-turn movements exceed 350 vph. DLTL's require a protected (exclusive) signal phase, a minimum 4' raised concrete median separating opposing traffic, and a width of at least 30' on the acceptance lanes (see Figure 3-23). The length of storage should accommodate at least 1.5 times the expected vehicles making left turns per cycle based on peak 15-min. periods.

When DLTL's are required, a capacity analysis of the intersection shall be performed to determine what traffic controls are necessary (i.e. - signalization, separate phasing) in order to have this double left-turn lane function properly.

For addition information on Dual Left Turn Lanes see AASHTO "Green Book" Chapter 9, Section 9.7.3.

Continuous Left-Turn Lanes (Two Way in Either Direction)

Continuous two-way median left-turn lanes (C2WMLTL's) should be considered on low-speed arterial highways (25 to 45 MPH) with no heavy concentrations of left-turn traffic. C2WMLTL's also may be used where an arterial or major route must pass through a developed area having numerous street intersections and entrances, and where it is impractical to limit left turns. The minimum width for this application shall be 13 feet, which is an 11 foot lane plus 2 feet for a solid yellow line and a dotted yellow line on each side of the 11 foot lane.*

C2WMLTL's shall only be used with roadways having a maximum of 2 through lanes in each direction, and shall be shown in accordance with Figure 3-24.

Advantages are:

- Reduced travel time.
- Improved capacity.
- Flexibility of using as temporary detour during closure of through lane.
- Does not control or limit the number of left turns.
- Minimizes interference to through traffic lanes.
- Separates opposing traffic flows by one full lane.
- Public preference (both from drivers and owners of abutting properties.)
- Reduced accident frequency, particularly rear-end collisions.

Disadvantages:

- Poor visibility (corrected by using proper delineation)

* Rev. 7/15

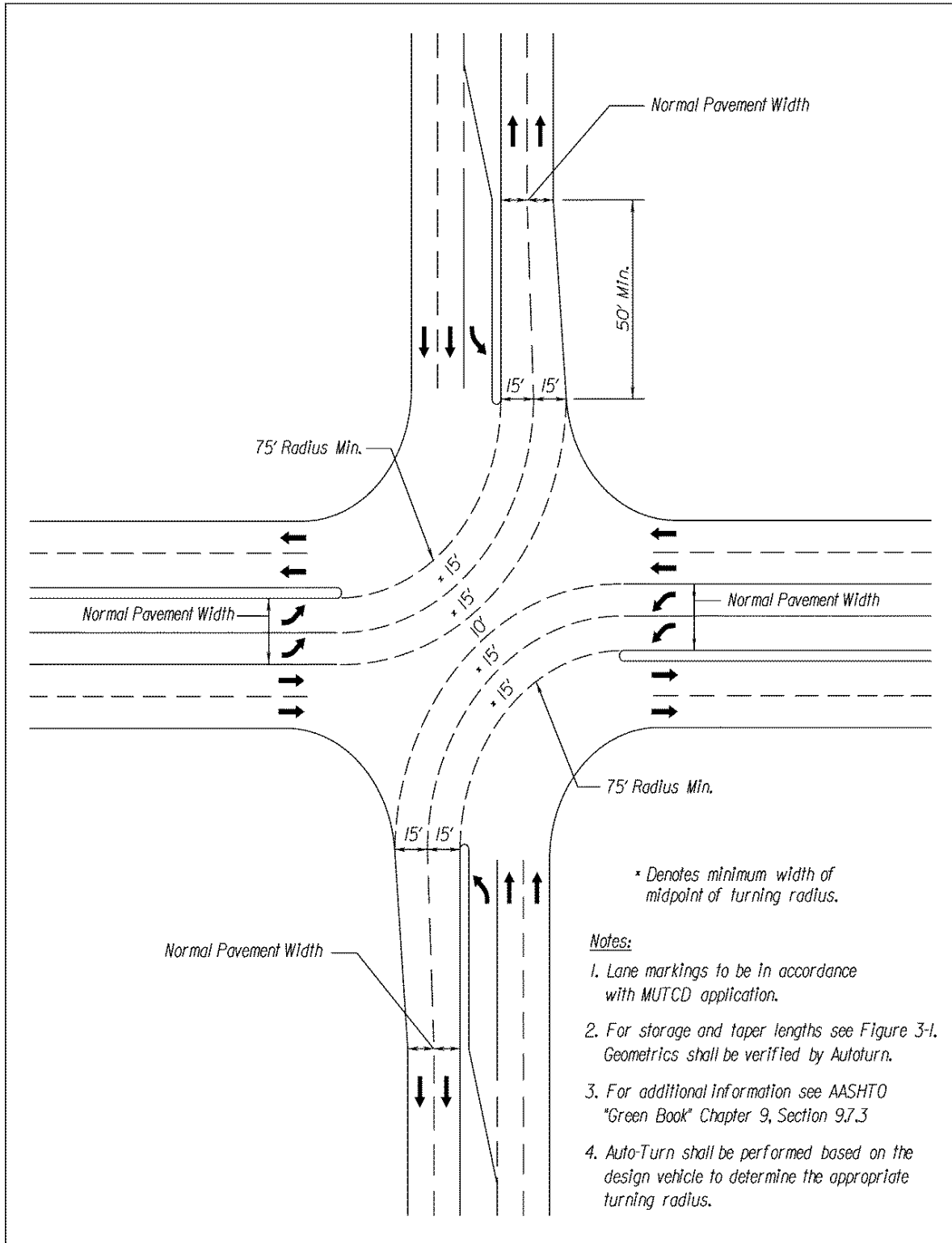
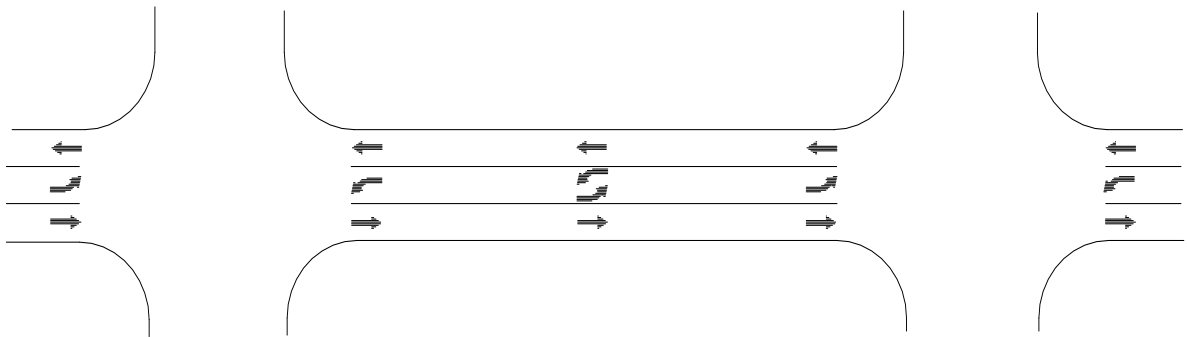
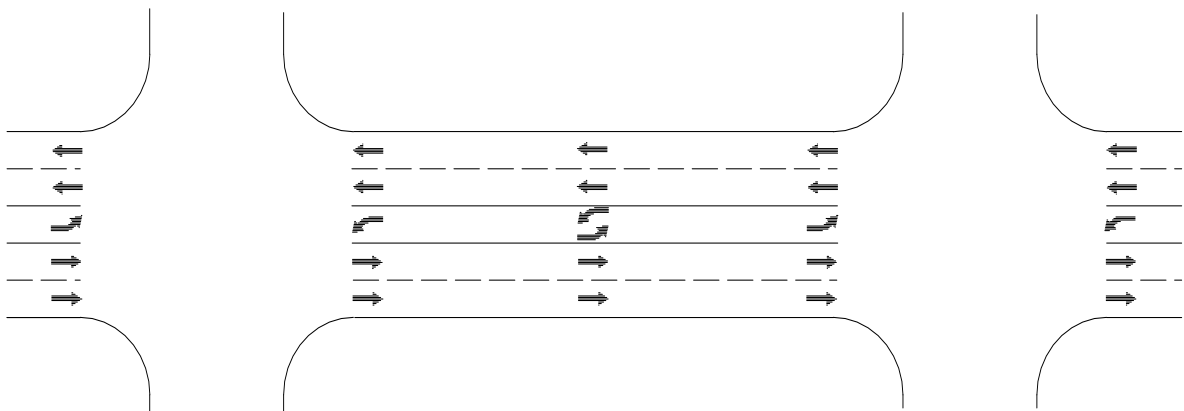

FIGURE 3-23 DOUBLE LEFT-TURN LANES*

* Rev. 1/14



Typical 3-Lane Configuration
W/Left Turn Provisions for the Minor Street



Typical 5-Lane Configuration
W/Left Turn Provisions for the Minor Street

FIGURE 3-24 CONTINUOUS TWO-WAY MEDIAN LEFT-TURN LANES
(Lane markings to be in accordance with MUTCD application)

Medians

Channelization: Positive channelization shall be provided for all median crossovers. Standard striping in accordance with the *Manual on Uniform Traffic Control Devices* (MUTCD) shall be used for all median crossovers and speed change lanes in medians without raised channelization. If new curbing is required it shall match the existing curb type of the median. Median crossovers on rural, high-speed highways shall be signed with Do Not Enter and One-way signs.

U-turns: The median width may be designed to permit U-turn movements. If a facility is too narrow to safely permit a U-turn, these movements should be addressed in design (such as flare outs in Figure 2-5) or restricted through signage. Sign use and placement require Department approval.

Pavement: Median paving shall be full depth and match the pavement section design of the existing roadway.

Drainage Function: Medians frequently provide a conveyance, detention or retention function for roadways. The installation of a median crossover shall not reduce the conveyance or storage capacity of the median.

Directional Median Crossovers for Left Turns and U-Turns

A directional median crossover for left turns and U-turns limits movements at median crossovers to specific turns only; the physical design actively discourages or prevents all other movements.

- The technique can be applied to unsignalized median crossovers on multilane divided urban and suburban streets.

Special Considerations

- The minimum width of a median nose has commonly been 4 feet. AASTHO recommends a minimum median width of not less than 4 feet and 6 to 8 feet wide is preferable where pedestrians may be present.
- Narrow median noses are difficult to see especially at night and in inclement weather. Reflectorized paint is of little help as it rapidly becomes dirty and loses its limited reflectivity. Reflectorized traffic buttons or reflectorized pylons help but lack the mass necessary to provide good target value.

- Carefully selected landscaping is the most effective way to ensure high visibility of the median and median **crossovers**.
- Landscaping of the median nose for visibility is especially important where long left-turn lanes are used. The choice of vegetation and the landscaping design must ensure that sight distance is not obstructed.
- Overlapping of the separators of a directional median **crossover** restricts movements to the intended left turn or U-turn.
- Directional median **crossovers** will accommodate U-turns by automobiles where the separation is at least 4 feet wide and there are three opposing lanes. Where there are two opposing lanes a triangular flare of 10 feet along the intersecting roadways and at least 20 feet along the major roadways will allow an automobile to execute a U-turn.

Advantages

- The directional median **crossover** for left turns and U-turns improves safety by limiting the number and location of conflict points and by prohibiting direct crossing.
- Right-angle crashes are avoided because vehicles are prevented from crossing where the median width is not sufficient for drivers to cross one-traffic stream at a time.

Disadvantages

- Cross-median movements are limited to specific locations and to specific turns.
- It is not practical to design for U-turns executed by large vehicles in all directions.

Illustration of Directional Median Crossover for Left Turns and U-Turns

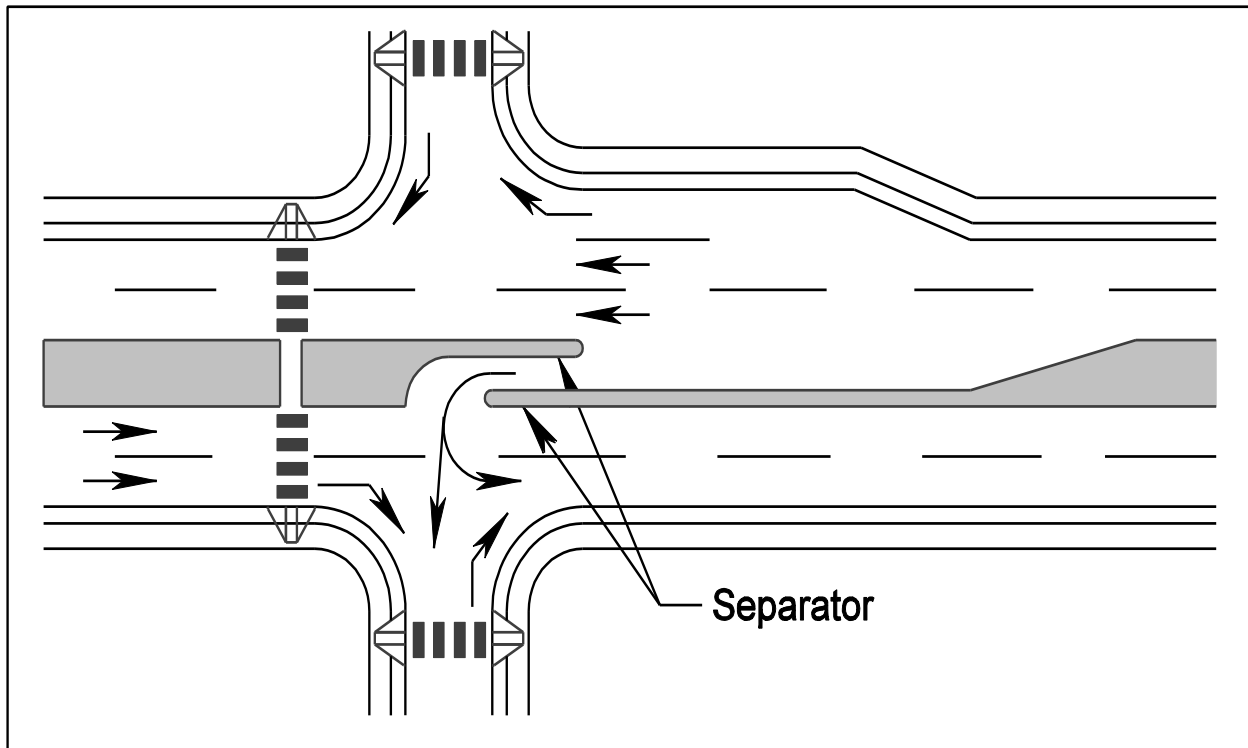

FIGURE 3-25 ILLUSTRATION OF DIRECTIONAL MEDIAN CROSSOVER FOR LEFT TURNS AND U-TURNS

Source: TRB, *Access Management Manual*, Dated 2003

Examples

- Some states make extensive use of directional median crossovers*. Preference is given to left turns and U-turns from the major roadway. Existing full median crossovers are reconstructed as directional crossovers as part of resurfacing projects or reconstruction projects. The minimum width of 2 feet can be accommodated in the standard 16 foot raised median. Separators are overlapped by at least 2 feet.
- The Michigan DOT has pioneered a variation of the directional median crossover called the Michigan U-Turn. This design involves the installation of directional crossover near signalized intersections.

* Rev. 1/14

Right Turn Lanes

An exclusive right-turn lane shall* be considered when the warrants in Figures 3-26 and 3-27 are met. Double exclusive right-turn lanes may be provided when capacity analysis warrants. Safety implications associated with pedestrians and bicyclists should always be considered.

These warrants are to be used as an aid in selecting appropriate treatments for right turn movements. (Reference material attained from Virginia Highway and Transportation Research Council Report "*The Development of Criteria For the Treatment of Right Turn Movements on Rural Roads*" dated March 1981).

1. Number of Lanes – Warrants are differentiated on the basis of the number of lanes on the major roadway. Refer to Figure 3-26 for 2-lane roadways and Figures 3-27 for 4-lane roadways. The minor roadway is a 2-lane road. Discussion on both figures is provided. All volumes refer to the volumes on the approach under consideration for right turn treatments.
2. Radius Treatment – Refer to Warrants for right turn treatment on 2-lane roadways. The predominant treatment for 2-lane roadways is the radius. Arterial roadways tend to carry higher volumes of traffic traveling at higher speeds as compared to local roadways.

The traffic on local roadways tends to include a higher number and percentage of right turning vehicles than that on arterials. An adjustment is needed to permit local roadways to handle more right turns (at lower speeds) compared to arterial roads. The following adjustment is made for posted speeds at or under 45 mph.

Adjusted Number of Right Turns = Number of Right Turns - 20 for number right turns > 40 and total volume < 300

For example, Total volume = 200 vph, Right turn volume = 70 vph and Posted speed = 40 mph. Then adjusted number of right turns - $r = 70 - 20 = 50$. Therefore, projecting a total volume 200 vph and $r = 50$ vph in the table, a radius is recommended for the right turn treatment.

3. Four lane Roadways – Four lane roadways tend to have a taper or full width lane to facilitate right turn movements. Many of these roads are divided highways with a speed limit of 55 mph.
4. Curb Channelized Island – Curb channelized island should be considered to separate right turn lanes from thru traffic based on capacity analysis.

* Rev. 1/15

5. Other factors – The selection of a treatment for right turn movements may be influenced by sight distance, availability of right-of-way, grade, and angle of turn. Although these factors are not incorporated in the guidelines, they should be given consideration. The guidelines should be used unless the Engineer at the District or Residency determines that special treatment is necessary due to other factors.
6. Data collection procedures – In order to employ these guidelines, peak hour volume data must be provided.

Right / Left Turn Lanes may be required beyond these guidelines at the discretion of the District *Engineer/Administrator's designee.

Conditions for providing an exclusive right turn lane when the right turn traffic volume projections don't exceed the guidelines:

- Facilities having a high volume of buses, trucks or trailers.
- Poor internal site design of a entrance facility causing potential backups in the through lanes.
- Heavier than normal peak flows on the main roadway.
- High operating speeds (such as 55 mph or above) and in rural locations where turns are not expected by through drivers.
- Highways with curves or hills where sight distance is impacted.
- Higher functionally classified highways shall be considered so that the impact of turning movements on highways intended to serve through traffic is minimized.

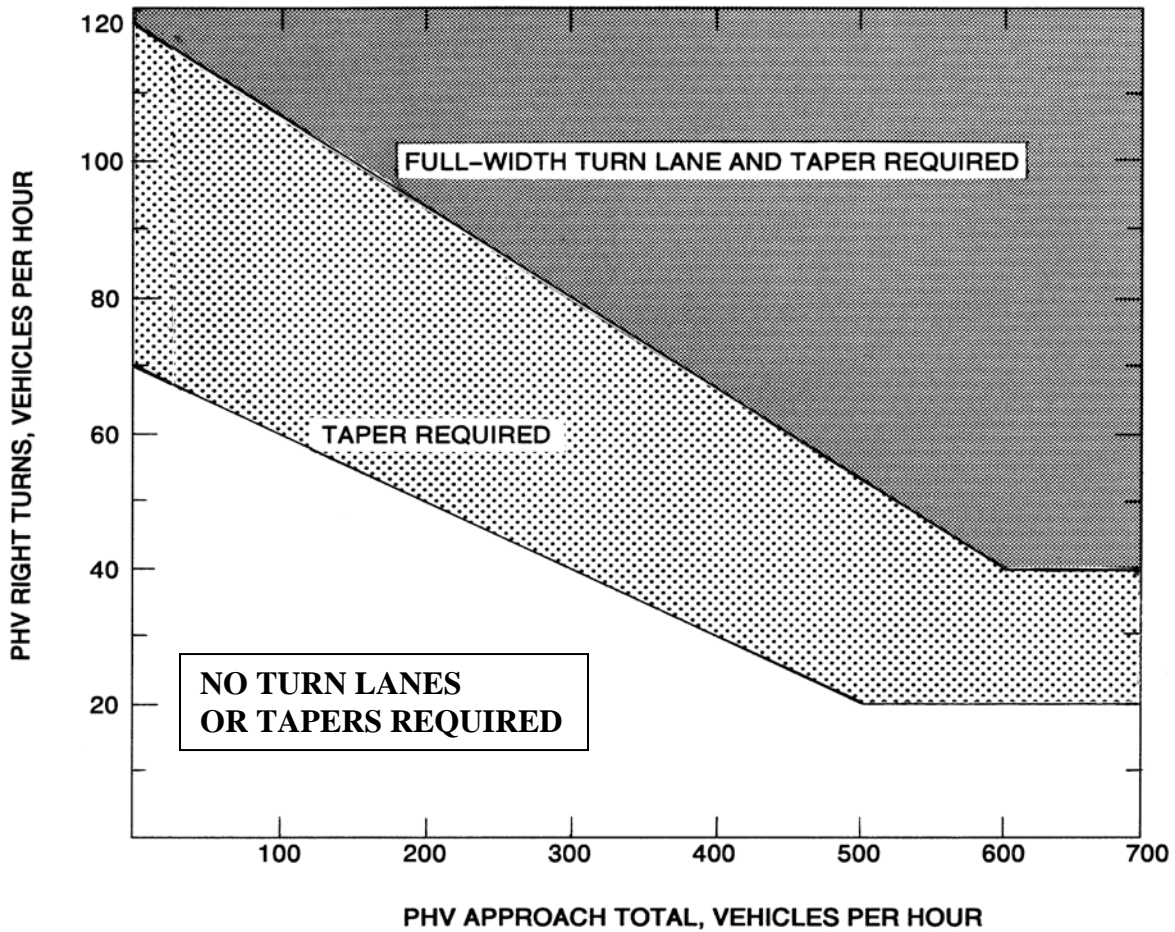

Appropriate Radius required at all Intersections and Entrances (Commercial or Private).

LEGEND

PHV - Peak Hour Volume (also Design Hourly Volume equivalent)

Adjustment for Right Turns

For posted speeds at or under 45 mph, PHV right turns > 40, and PHV total < 300.

Adjusted right turns = PHV Right Turns - 20

If PHV is not known use formula: $PHV = ADT \times K \times D$

K = the percent of AADT occurring in the peak hour

D = the percent of traffic in the peak direction of flow

Note: An average of 11% for K x D will suffice.

When right turn facilities are warranted, see Figure 3-1 for design criteria.*

FIGURE 3-26 WARRANTS FOR RIGHT TURN TREATMENT (2-LANE HIGHWAY)

* Rev. 1/15

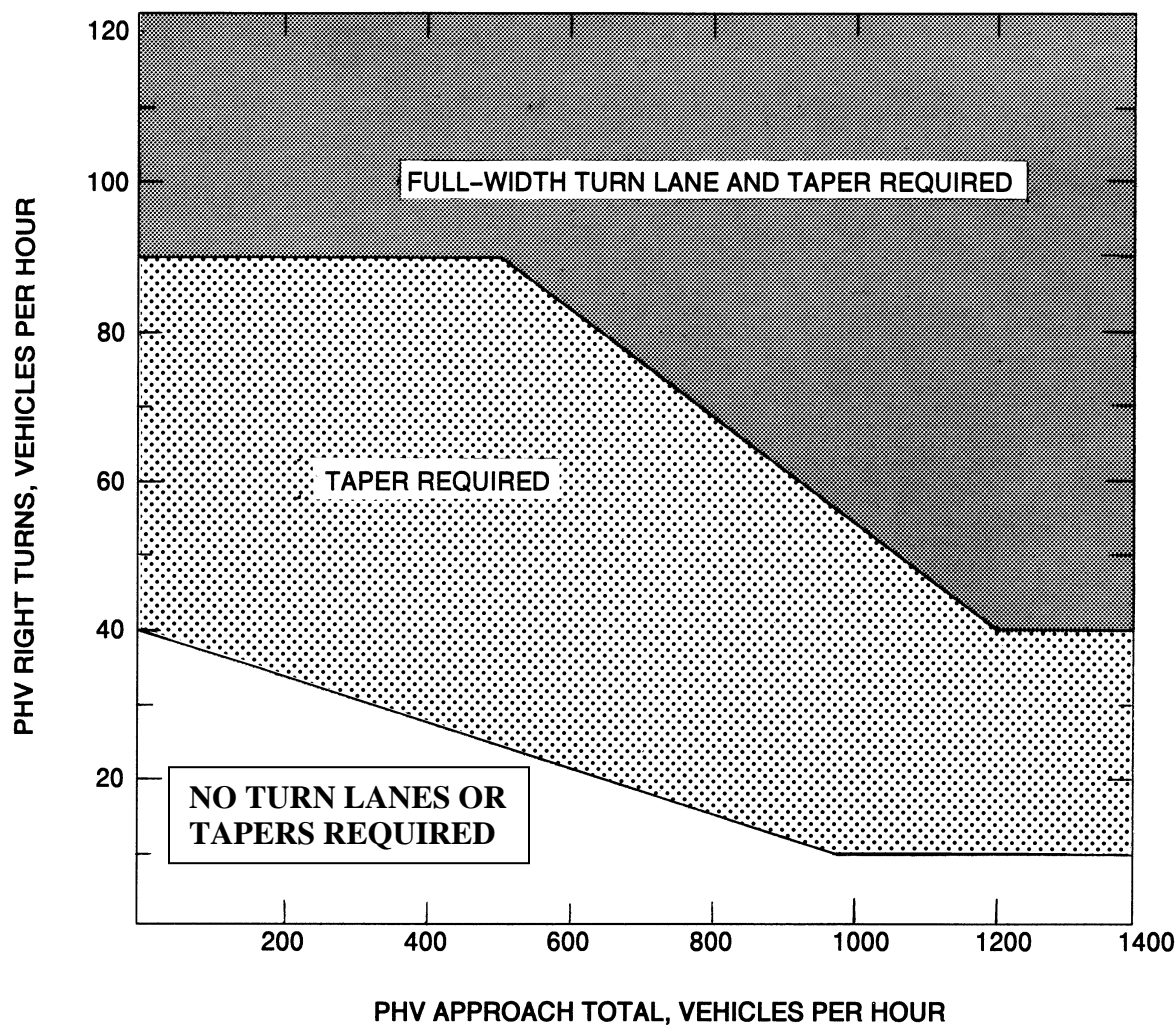

Appropriate Radius required at all Intersections and Entrances (Commercial or Private).

LEGEND

PHV- - Peak Hour Volume (also Design Hourly Volume equivalent)

Adjustment for Right Turns

If PHV is not known use formula: $PHV = ADT \times K \times D$

K = the percent of AADT occurring in the peak hour

D = the percent of traffic in the peak direction of flow

Note: An average of 11% for K x D will suffice.

When right turn facilities are warranted, see Figure 3-1 for design criteria.*

FIGURE 3-27 WARRANTS FOR RIGHT TURN TREATMENT (4-LANE HIGHWAY)

* Rev. 1/15

Acceleration/Deceleration Lanes

Acceleration lanes shall be considered on high speed roadways (Design Speed 50 mph and greater) where WB 67* vehicles will be entering the roadway. See Figure 3-32.

Acceleration/Deceleration lanes shall consist of a full-width lane and a transition taper. Acceleration lanes should be designed so that a turning vehicle will obtain the highway posted speed at the point where the full -width lane ends and transition taper begins.

- Acceleration Lane: See AASHTO Green Book, Chapter 10, Section 10.9.6, page 10-110, Table 10-3 Minimum Acceleration Lengths for Entrance Terminals with Flat Grades of 2% or Less.
- Deceleration Lanes: Storage and Transition Taper: See Section 3 – Turning Lanes, Figure 3-1 Left and Right Turn Lanes Criteria in this chapter. See Figure 3-28, and 3-30.
- Transition Taper: See Section 3 – Turning Lanes, Figure 3-1 Left and Right Turn Lanes Criteria in this chapter.

Bus Pullout

- See Appendix C

Left Turn Deceleration Lane

- See Figure 3-31

* Rev. 1/18

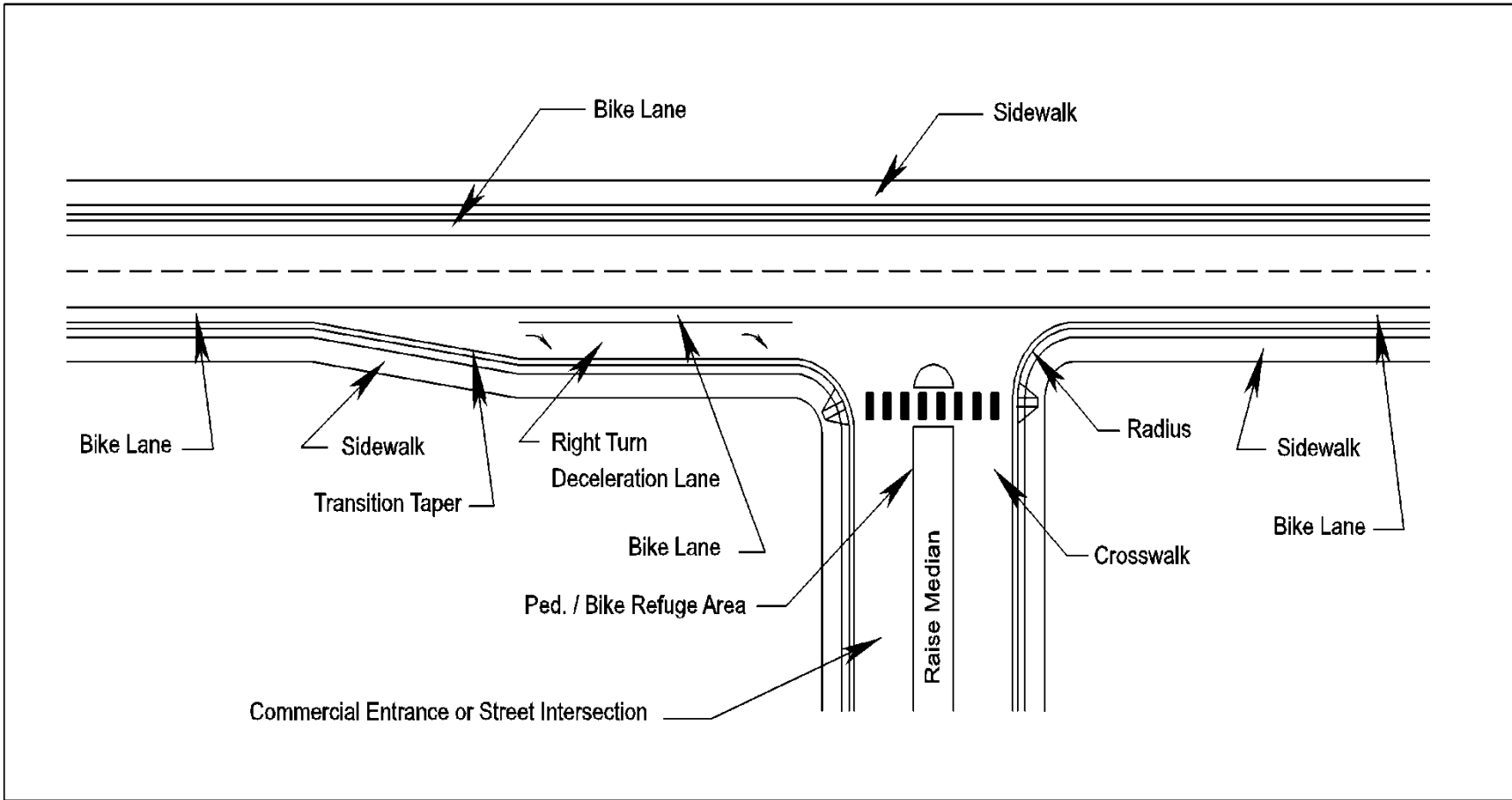

FIGURE 3-28 TYPICAL APPLICATION WITH SIDEWALKS AND BIKE LANES WITH RIGHT-TURN DECELERATION LANES (CURB AND GUTTER SECTION)

Note: All entrance design and construction shall accommodate pedestrian and bicycle users of the highway in accordance with the Commonwealth Transportation Board’s “Policy for Integrating Bicycle and Pedestrian Accommodations”.

SEE BUS TURNOUT (BUS STOP) DESIGN: LOCATION, TYPE AND DIMENSIONS IN [APPENDIX A\(1\)](#)*

FIGURE 3-29 TYPICAL APPLICATION OF A BUS PULLOUT

* Rev. 7/18

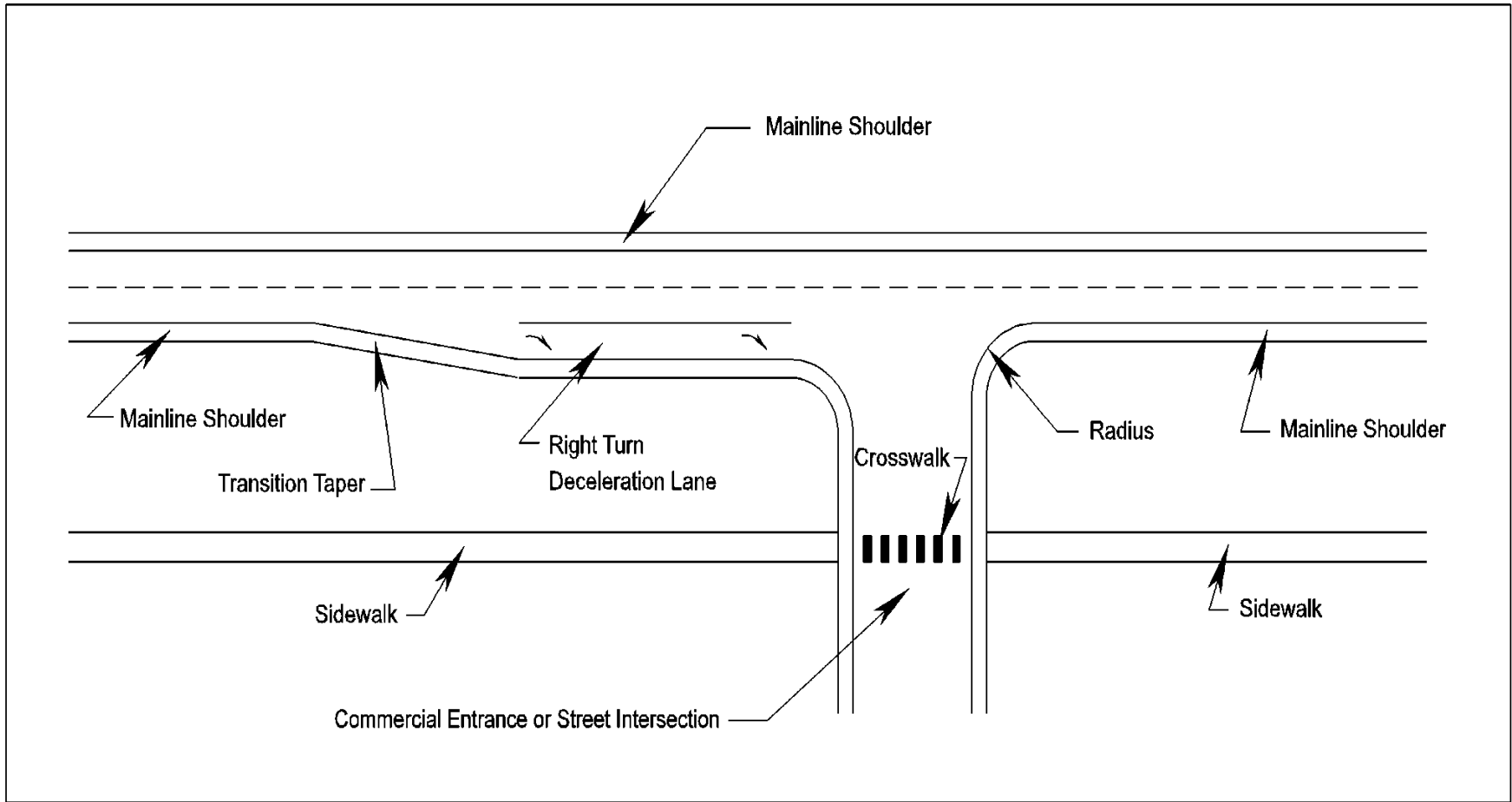

FIGURE 3-30 TYPICAL APPLICATION OF A RIGHT TURN DECELERATION LANE (SHOULDER SECTION)

Note: All entrance design and construction shall accommodate pedestrian and bicycle users of the highway in accordance with the Commonwealth Transportation Board’s “Policy for Integrating Bicycle and Pedestrian Accommodations”.

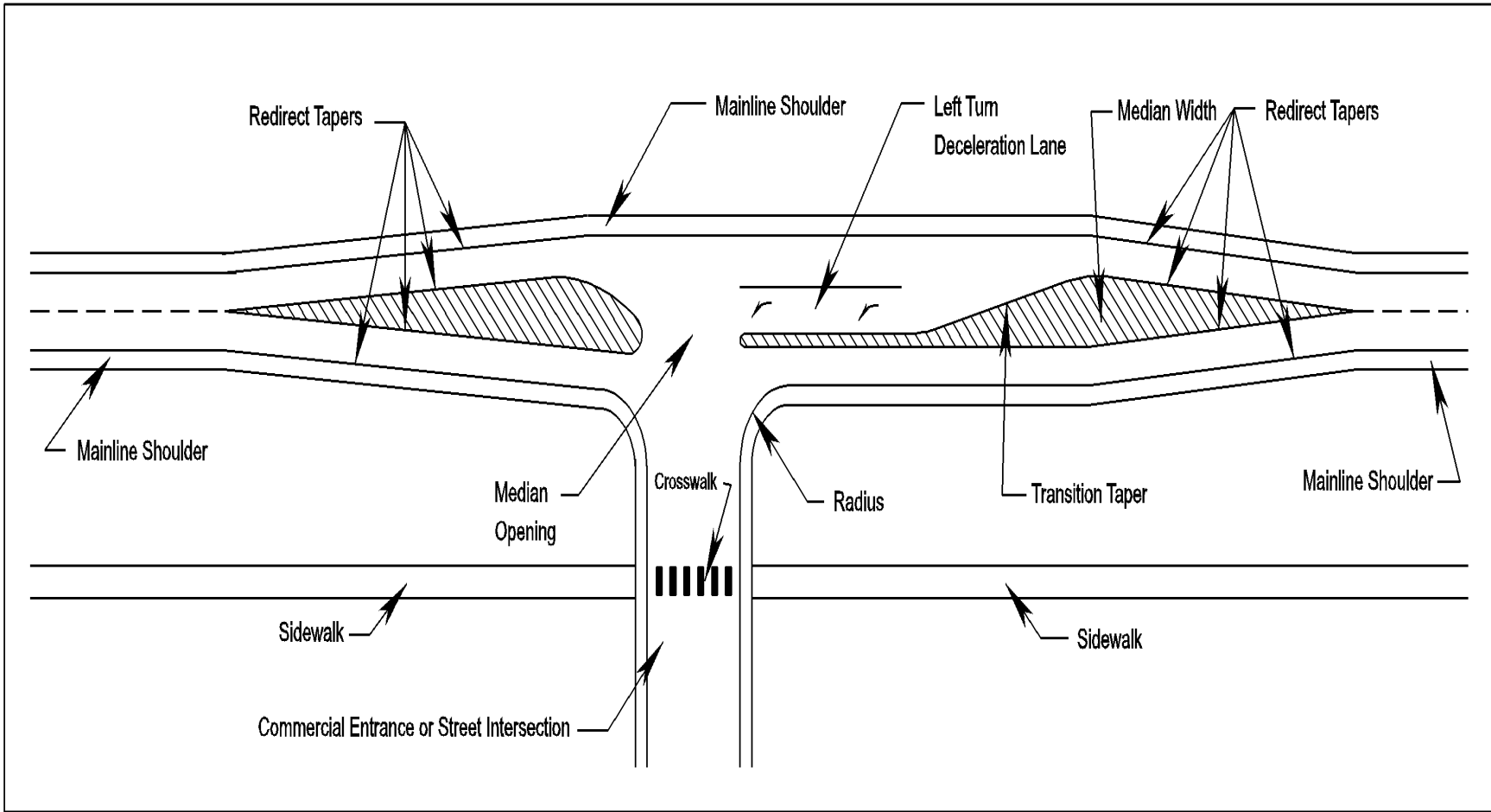
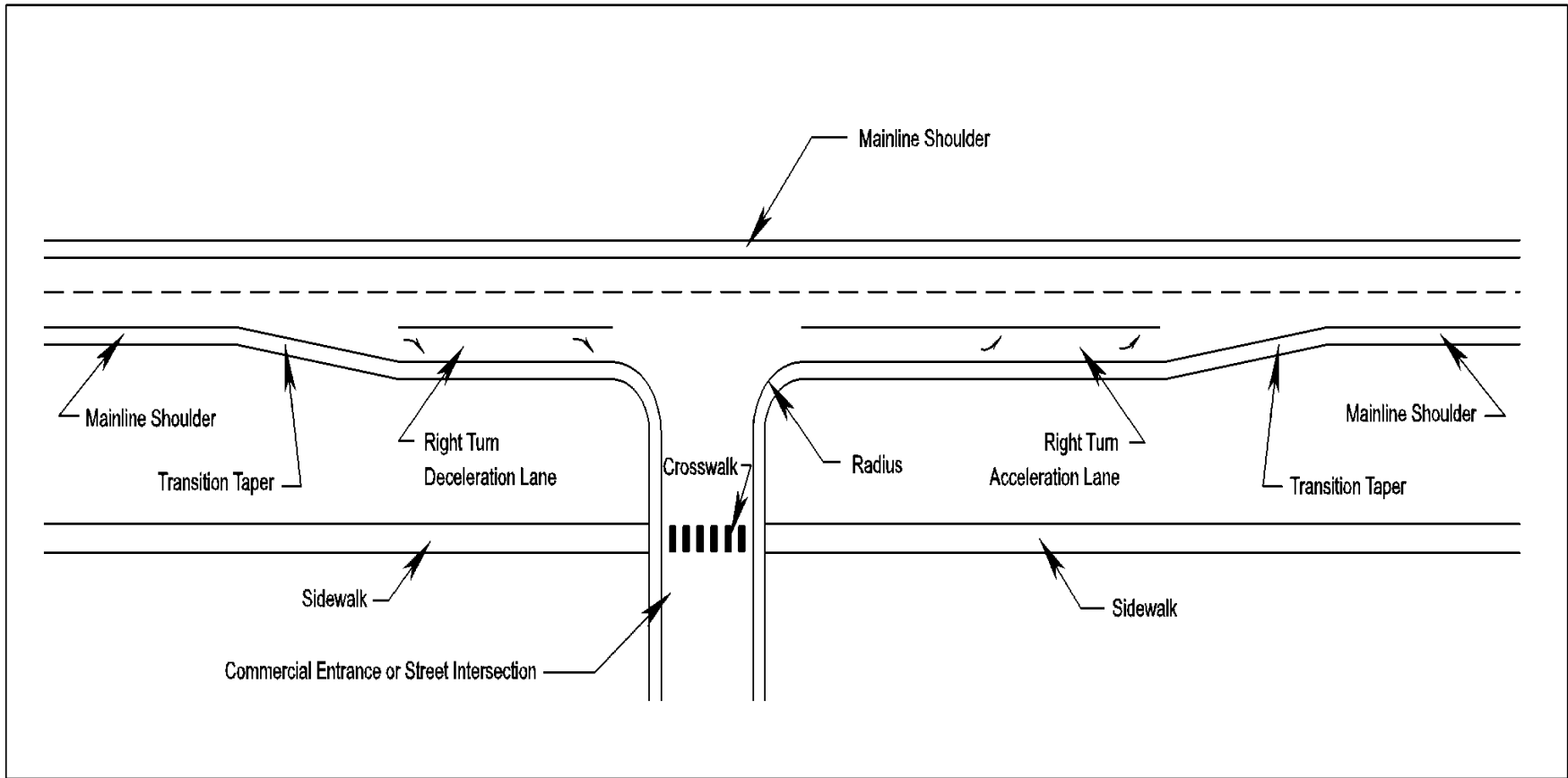

FIGURE 3-31 TYPICAL APPLICATION OF A LEFT TURN DECELERATION LANE (SHOULDER SECTION)

Note: All entrance design and construction shall accommodate pedestrian and bicycle users of the highway in accordance with the Commonwealth Transportation Board’s “Policy for Integrating Bicycle and Pedestrian Accommodations”.



**FIGURE 3- 32 TYPICAL APPLICATION OF A RIGHT TURN ACCELERATION AND DECELERATION LANE
(SHOULDER SECTION)**

Note: All entrance design and construction shall accommodate pedestrian and bicycle users of the highway in accordance with the Commonwealth Transportation Board’s “Policy for Integrating Bicycle and Pedestrian Accommodations”.

SECTION 4 – ENTRANCE DESIGN

Entrance Design Principles

All* entrances are, in effect, at-grade intersections and are designed consistent with the intended use. Entrance design and location merit special considerations in order to reduce the number of crashes that occur at entrances.

At Intersections: Entrances shall not be situated within the functional area of an intersection or in the influence area of an adjacent entrance. The functional area extends both upstream and downstream from the physical intersection area and includes the longitudinal limits of auxiliary lanes, see Figure 4-2A.

Entrance Angle: The entrance centerline should be perpendicular to the state highway centerline and extend tangentially for a minimum distance of 40 feet beyond the near-side edge line. An acute angle between 60 degrees and 90 degrees may be permitted if significant physical constraints exist. Acute angles less than 60 degrees shall require special approval of the Department.

Type of Entrance	Design	Sight Distance	Access Management*	Permit
Commercial	Figures 4-8 to 4-14	Intersection	Yes	Commercial
Commercial: Moderate Volume	Figure 4-15	Intersection	Yes	Commercial
Low Volume Commercial	Figure 4-1	Stopping	No	Commercial
Private	Figure 4-1	Best possible	No	Private

TABLE 4-1 ENTRANCE TYPES AND RULES

*NOTE: See [Section 120, Access Management Regulations](#)

Entrance Definitions

Commercial Entrance: Any entrance serving land uses that generate more than 50 vehicular trips per day or the trip generation equivalent of more than five individual private residences or lots for individual private residences using the methodology in the Institute of Transportation Engineers *Trip Generation*. See Figures 4-8 to 4-14.

Private Subdivision Road/Street Commercial Entrance: Any entrance for a road or street that serves more than five individual properties and is privately owned and maintained.

Low Volume Commercial Entrance: Any entrance, other than a private entrance, serving five or fewer individual residences or lots for individual residences on a privately owned and maintained road or land uses that generate 50 or fewer vehicular trips per day using the methodology in the Institute of Transportation Engineers *Trip Generation*.

* Rev. 7/14

Moderate Volume Commercial Entrance: A commercial entrance along highways with shoulders with certain site and design criteria reduced. Site requirements are:

- Maximum highway vehicles per day: 5,000
- Maximum entrance vehicles per day: 200
- Maximum entrance percent truck trips of vehicles per day: 10%

The reduced design criteria are (i) Minimum entrance throat depth is 25 feet; (ii) Minimum radii is 25 feet with curb/gutter or curbing not required; (iii) Entrance width is 18 feet minimum, 30 feet maximum; and (iv) Minimum angle of entrance is 60 degrees.*

See Figure 4-15 for the moderate volume commercial entrance design illustration.

Private Entrance: An entrance that serves up to two private residences and is used for the exclusive benefit of the occupants or an entrance that allows agricultural operations to obtain access to fields or an entrance to civil and communication infrastructure facilities that generate 10 or fewer trips per day such as cell towers, pump stations, and stormwater management basins.

Private and Low Volume Commercial Entrances

All private and low volume commercial entrances shall be designed in accordance with the entrance design criteria below and Figure 4-1 to promote safe and efficient movement of vehicles in the entrance and on state highways.

Low Volume Commercial Entrance Stopping Sight Distance

Adequate stopping sight distance is required for low volume commercial entrances, as specified in the Stopping Sight Distance Tables 2D-1 and 2D-2.

Private Entrance Sight Distance

The installation of a private entrance cannot be denied on the basis of sight distance. VDOT will review the property owner's highway frontage and determine a useable location for the private entrance with the *best possible sight distance*.

The property owner's preferred location can be denied by the Department if the location does not have the best possible sight distance and therefore is less safe for users of the entrance as well as for motorists on the intersecting highway.

The Department may require the property owner to grade slopes, clear brush, remove trees, and conduct other similar efforts necessary to provide the safest possible means of ingress and egress that can be reasonably achieved.

Private and Low Volume Commercial Entrance Curb and Gutter

Standard entrance gutter (Std. CG-9D; other options are CG-9A or CG-9B) shall be used with Std. CG-6 or CG-7 curb and gutter. A special design entrance gutter shall be submitted for approval when roll top curb is used.

Private and Low Volume Commercial Entrance Design Criteria

All private and low volume commercial entrances shall be designed and constructed as noted below and shown in Figure 4-1. Entrance radius shall be 20' minimum.

* Rev. 1/17

Entrance pipe culverts shall be sized to accommodate the run-off expected from a 10-year frequency storm. Alternate methods for placing pipe culverts under the entrance (cut/fill details) are presented in the PE-1 design standard illustration in the *VDOT Road and Bridge Standards*, Section 600, available on the VDOT web.

All private and low volume commercial entrance grades shall start back of the shoulder line. If drainage is necessary, the ditch line may be moved back to provide 9 inches minimum cover over pipe.

Entrances shall be at least 12' wide and tied smoothly into the roadway surface.

The entrance surface can be crusher run aggregate (gravel), asphalt, concrete, etc. and shall extend from the edge of the roadway to the right-of-way line.

Private and Low Volume Commercial Entrance Grades

In the interest of assuring an adequate, convenient, and safe access to public roads, VDOT recommends the grades along such entrances not exceed 10%. When grades do exceed 10%, consideration should be given to paving the entrance.

Modification of an Existing Private or Low Volume Commercial Entrance

When an existing street is re-developed and modification of an existing entrance is required, the entrance surface shall be extended to the right-of-way line or the extent of disturbance to the existing entrance.

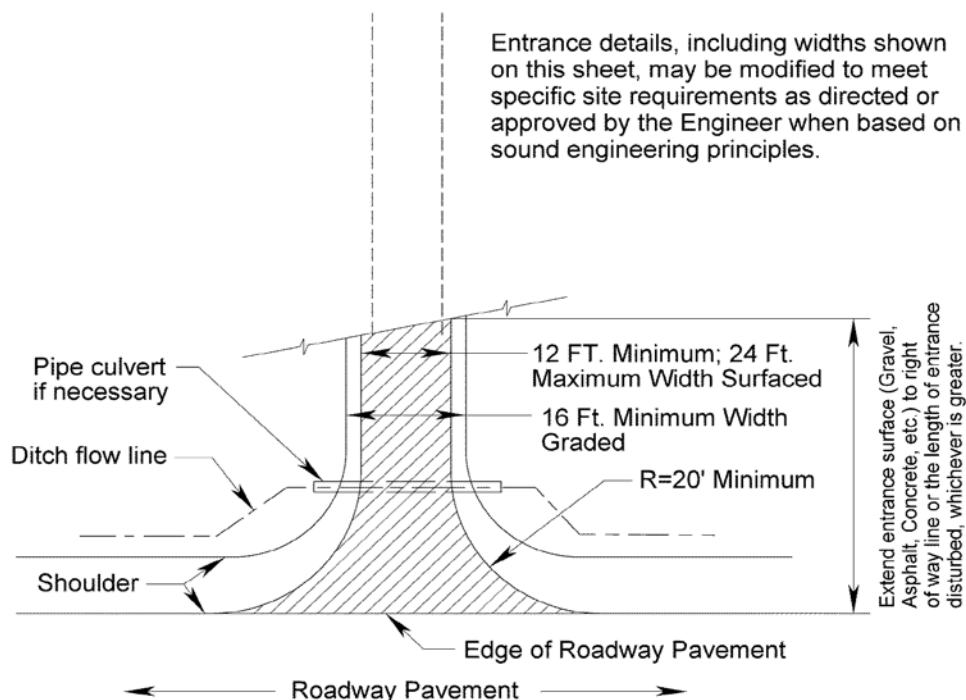

FIGURE 4-1 PRIVATE ENTRANCE AND LOW VOLUME COMMERCIAL ENTRANCE DETAIL

Commercial Entrances

Commercial entrances shall be designed according to the entrance design diagrams Figures 4-8 to 4-15 to promote safe and efficient movement of vehicles in the entrance and on state highways.

To assure that commercial entrances are designed to provide for safe and efficient movements, it is necessary to pay attention to critical dimensions and design features listed below.

- Radius of curved approach/exit of entrance.
- Flare size of angled approach/exit of entrance.
- Entrance distance or spacing between entrances.
- Corner clearance measured from a major intersection.
- Angle of entrance.
- Sight distance length of roadway visible to the driver required for vehicles to make safe movements.
- Entrance location in relation to other traffic features such as intersections, neighboring entrances, and median crossovers.
- Entrance throat distance needed into site to transition vehicles to the internal circulation system of the site.
- Right turn lanes to separate through and turning traffic on roadways to facilitate right turns into the entrance.

Entrance Sight Distance: Commercial entrances shall be placed at locations that provide adequate intersection sight distance. In hilly areas, proper locations can be at a premium, and shared access may be necessary. For more information see the Commercial Entrance Intersection Sight Distance section below.

Entrance to Parking Areas: An access shall not be approved for parking areas that require backing maneuvers within state highway right-of-way. All off-street parking areas must include on-site maneuvering areas and aisles to permit vehicles to enter and exit the site in forward drive without hesitation. For Parking Space Guidelines See [Appendix A\(1\)](#).

Entrance Throat: The entrance throat is designed to facilitate the movement of vehicles off the highway to prevent the queuing of vehicles on the traveled way. Entrance throats apply to commercial entrances, corner clearance establishes the “Throat” of a minor street intersecting a major street.

The throat length is based on the traffic a development will generate, not the characteristics of the abutting highway. The more traffic using the commercial entrance, the greater the number of ingress/egress lanes will be needed within the entrance, which determines the length of the entrance throat.

Both sides of the entrance throat need to be protected. The length of the entrance-side throat equals the exiting throat. When entering vehicles stop to turn left there must be sufficient queuing length to prevent other entering vehicles from backing up on to the highway. Minimum connection throats are provided in the table below.

Summary of Entrance Throats	
Number of Egress Lanes (left, thru and right)	Minimum Throat Length
	Feet
1	35 *
2	75
3	200
4	300

TABLE 4-2

Source: *Transportation & Land Development 2nd Edition 2003*, Koepke and Stover

* Inadequate entrance length can also produce hazards to entering traffic on site. Particularly where the on-site parking can back out of and block the entrance and prevent a vehicle from entering. To avoid this problem, a distance of at least 50 feet is used on entrance length where back out parking may interfere with entry movement.

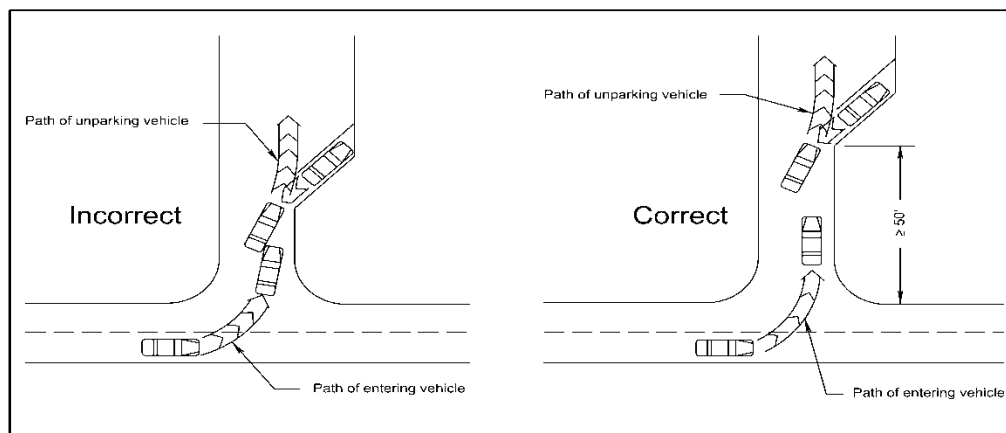

FIGURE 4-1A ENTRANCE THROAT DETAIL

Entrance Pavement: The type and depth of the pavement shall be clearly indicated on the plans and/or permit application. The pavement of commercial entrances, turn lanes and tapers shall be of asphalt, concrete, or pavers that is of a construction comparable to the pavement of the adjacent roadway.

Entrance Grade: The vertical alignment of all access locations is designed to minimize vehicle bounce and prevent high-centering of vehicles with a maximum clearance of 4 inches. The maximum grade change for a commercial entrance is 8%.

Steeper access entrances require the District L&D Engineer approval. A landing area shall be provided at each access to ensure proper sight distance from the access. The level area is measured from the highway edge of pavement or from the back of sidewalk, whichever is appropriate based on site-specific conditions.

* Rev. 7/15

Entrance Cuts: The maximum vertical curve, crest or sag, shall have a maximum 4-inch vertical offset over a 10-foot chord length. A standard vertical curve is designed for all commercial entrance profiles that exceed 3.3%.

Entrance Drainage: Drainage shall be considered in the design of entrance grades. Roadways and curb-and-gutter sections that convey storm water runoff within the roadway prism are designed in accordance with department standards. Site runoff into state right-of-way shall be minimized.

Entrance Width: All commercial entrances shall have a width sufficient for the particular land use and anticipated traffic flow with a **minimum** width of 16 feet for a one-way drive and 30 feet for a two-way drive (a two-way commercial entrance on a *local street* shall have a minimum width of 24 feet). Note: The width of the entrance shall be wide enough so that the design vehicle does not encroach into the opposing lane when entering the entrance.* The **maximum** width is 20 feet for a one-way drive and 40 feet for a two-way drive. See "Entrance Width" in Definitions Section.

These widths are measured at right angles to the centerline of the entrance at the right-of-way line. Entrances with multiple lanes or median may require additional width. For subdivision streets, radii width and angle are established in the Subdivision Street Design Guide in the Road Design Manual, Appendix B (1), at web link

<http://www.virginiadot.org/business/locdes/rdmanual-index.asp>

Design Vehicle: The type of vehicle that makes frequent turns without encroaching into the adjacent lane when making turns. The tracking of the design vehicle is an important determinant of corner radii at intersections. When the design vehicle traverses an intersection, the design vehicle shall be able to turn from one street to another without deviating from the near travel lane and impeding other traffic flow. Therefore, the design vehicle determines the elements of design such as turning radius and lane width. The design vehicle is to be determined based on the LD-104 Request for Traffic Data and discussed at the Project Scoping Meeting and recorded on the Scoping Worksheet - Roadway Design.

The WB-67 shall be the design vehicle used for intersections of freeway ramp terminals with other arterial crossroads and for other intersections on state highways and industrialized streets that carry high volumes of traffic or that provide local access for large trucks.

Entrance Radius: The entrance radius shall be designed to accommodate the design vehicle expected to use the commercial entrance on a daily basis and have radii large enough to accommodate the largest design vehicle that will use it without creating undue congestion or hazard on the through highway (See Table 4-3).

* Rev.1/18

Design Vehicle and Turning Radius by Land Use		
Land Use(s) Served by Access	Design Vehicle	Radius (Minimum) *
Office with Separate Truck Access	Passenger Car/Pickup	25
Office without Truck Access	Single Unit Truck SU-30	45
Commercial / Retail with Separate Truck Access	Passenger Car/Pickup	25
Commercial / Retail without Separate Truck Access	WB-67 Truck	50
Industrial with Separate Truck Access	Passenger Car/Pickup	25
Industrial without Separate Truck Access	WB-67 Truck	50
Recreational without Watercraft Access or Camping	Passenger Car/Pickup	25
Recreational with Watercraft Access or Camping	Motor Home/Boat	50
Agricultural Field Access	Single Unit Truck SU-30	45
Municipal and County Roads	WB-67 Truck	50

TABLE 4-3 DESIGN VEHICLE AND TURNING RADIUS BY LAND USE

Note: "with Separate Truck Access" indicates truck prohibition from primary access.

The minimum entrance radius allowed is 25 feet and the minimum exit radius allowed is 25 feet. Entrances into mixed use developments are designed to accommodate the largest design vehicle expected to use that entrance.

Where on-street parking is allowed near the commercial entrance, the *effective* radius for the entrance shall be used. Typically the effective radius will be the actual radius of the entrance curbing plus the width of the parking lane (for example 12.5 ft curb radius plus 8 ft wide parking lane resulting in an effective radius of 20.5 feet).

For subdivision streets, radii width and angle are specified in the Subdivision Street Design Guide in the Road Design Manual, Appendix B (1). See above web link.

Auxiliary Lanes and Tapers: When a land use will generate high traffic volumes, auxiliary lanes and tapers may be required. Auxiliary lanes and tapers shall be located within right-of-way. See Section 3 Turning Lanes for more information.

Angled Entrances: When the property owner desires to construct dual commercial entrances at other than 90 degrees to the centerline of the road, an entrance on the right side as approaching should not have less than a 60 degree angle with the centerline of the road.

Entrance Profile: All commercial entrances are built to a sidewalk elevation at the right-of-way line. Beyond the right-of-way line, the grade should not exceed 8 percent. Entrance configurations are shown starting at Figure 4-8.

* Rev.1/18

Entrance Medians: Commercial entrance medians are used when two or more lanes are required for both the entering and the exiting movements at the entrance.

- Entrance medians shall have a minimum width of 4 feet.
- The minimum size of an entrance median island is 100 square feet.
- All curbing within the highway clear zone shall be in accordance with VDOT's *Road and Bridge Standards*, or as approved by the District *Engineer/Administrator or designee, and appropriate for the operational speeds of the facility.
- Non-regulatory signs shall not be placed in the portion of an entrance median located within the right-of-way, or within the highway clear zone, and shall not restrict intersection sight distances.
- An entrance median should not contain structures, signs, or landscaping which restrict sight distance.

Entrance Pedestrian Accommodation: Design criteria for sidewalks at commercial entrances (by providing pedestrian access routes across the entrance) are presented in diagram CG-11 in the *Road and Bridge Standards* at the following web link:

http://www.virginia-dot.org/business/locdes/2008_standards_complete_sections.asp.

COMMERCIAL ENTRANCE SIGHT DISTANCE

Entrances shall be located to provide adequate intersection sight distance. Intersection sight distance criteria are illustrated below and the sight distance requirements are presented in Table 2-5. The line of sight establishes the boundary of a sight triangle within which there is no sight obstruction. At any location where the sight line leaves the right-of-way, a permanent easement must be maintained, and the area must be graded and landscaped such that sight distance is not compromised, for a commercial entrance to be approved. (For an Appeals Process, see Access Management Regulations: (24VAC30-73-50 B).

Offsets: Improvements on public or private property adjacent to the right-of-way shall be located so that parking, stopping, and maneuvering of vehicles within the highway right-of-way will not occur. The minimum distance from the right-of-way line for all structures and sight obstructions is the clear zone. At all commercial entrances and intersections, an adequate sight triangle shall be provided. The minimum setback point for the sight triangle is 14.5 feet from the near-side extended highway edge of pavement.

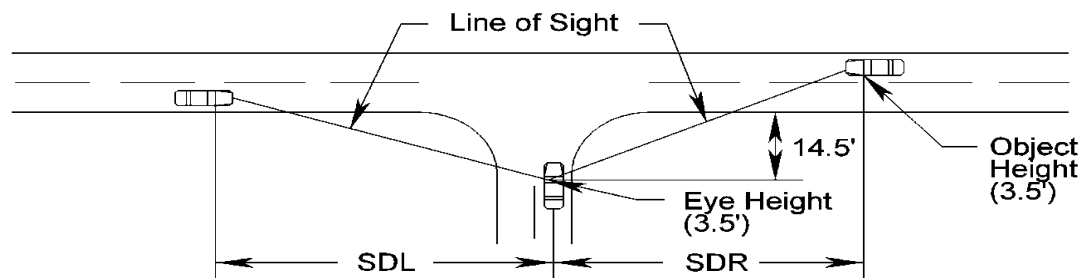

SDR = Sight Distance Right (For a vehicle making a left turn)
 SDL = Sight Distance Left (For a vehicle making a right or left turn)

All site plans for proposed developments shall show the location of all proposed and existing entrances within the area of the proposed development. The location of all proposed commercial entrances shall be reviewed to determine if proper spacing will be maintained.

Limits of Maintenance Responsibility for Private and Commercial Entrances

See the Access Management Regulations Section 90 for details on private entrance maintenance responsibilities and Section 110 on maintenance responsibilities for commercial entrances.*

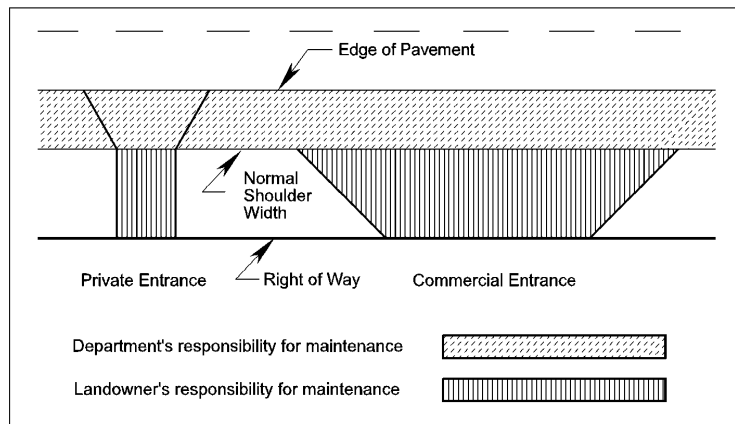

FIGURE 4-2

Commercial Entrance Separation from an Intersection

Entrances shall not be placed within the functional area of any intersection. If however, existing entrances are located within the functional area of the intersection Part A of the Waiver Form AM-W shall be completed and submitted to the District Location and Design Engineer for approval. Greater spacing may be required due to stacking requirements of the approaches to the intersection. This can be particularly evident around signalized intersections. The Access Management Regulation 24VAC30-73-120 requires commercial entrances to be located out of the functional area of an intersection.

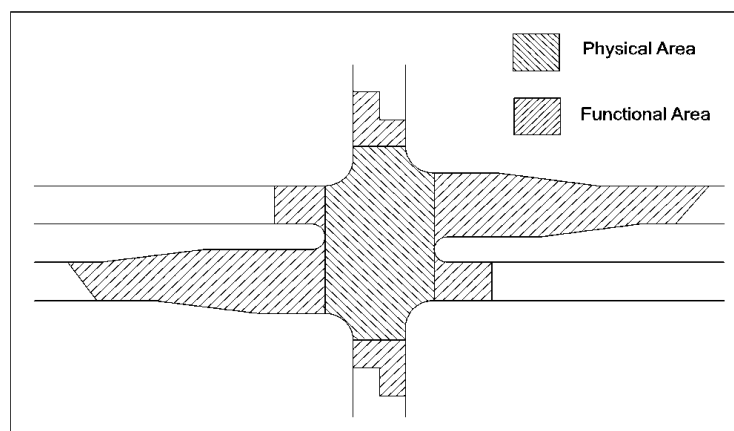

FIGURE 4-2A PHYSICAL AND FUNCTIONAL AREAS OF INTERSECTION

Source: FHWA, *National Highway Institute Course No. 15255*

* Rev. 1/15

AASHTO specifically states that “a driveway should not be located within the functional boundary of an intersection”. The functional area on the approach to an intersection consists of three basic elements: perception-reaction decision distance, maneuver distance, and queue-storage distance. These elements are identified in Figure 4-3. The distance traveled during the perception-reaction time will depend on such factors as vehicle speed. Where there is a left or right turn lane, the maneuver distance includes the length needed for both braking and lane changing. In the absence of turn lanes, it involves braking to a comfortable stop. The storage length should be sufficient to accommodate the longest queue expected most of the time.

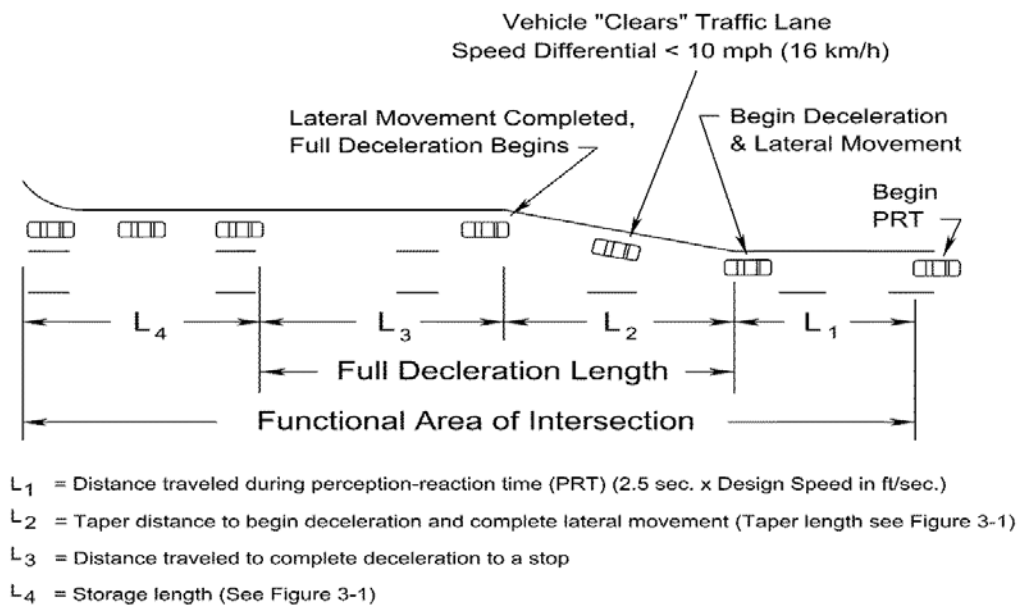

FIGURE 4-3 ELEMENTS OF THE FUNCTIONAL AREA OF INTERSECTION

SOURCE: 2011 AASHTO Green Book, Chapter 9, Section 9.7.2

Restricting Left Turn Movements at Commercial Entrances

The most effective way to prevent left turn movements at entrances is through the use of restrictive medians. Where space for a raised median is available within the road (AASHTO recommends a minimum median width of 4 feet), it can be installed along the front of the entrance for a sufficient distance to prevent left turns (see Medians in section 3 for additional information).

Another alternative when there is not enough space for a raised median is the use of flexible traffic posts with reflective striping to serve as a visual and physical barrier to left turn ingress and egress at an entrance.

Finally, although less effective than restrictive medians, channelization islands can be installed within the commercial entrance throat to prevent left turn ingress and/or egress movements to create a right-in and/or right-out entrance on an undivided highway. Figure 4-4 presents illustrations of commercial entrance channelization island options.

* Rev. 1/14

Commercial Entrance Channelization Island Options

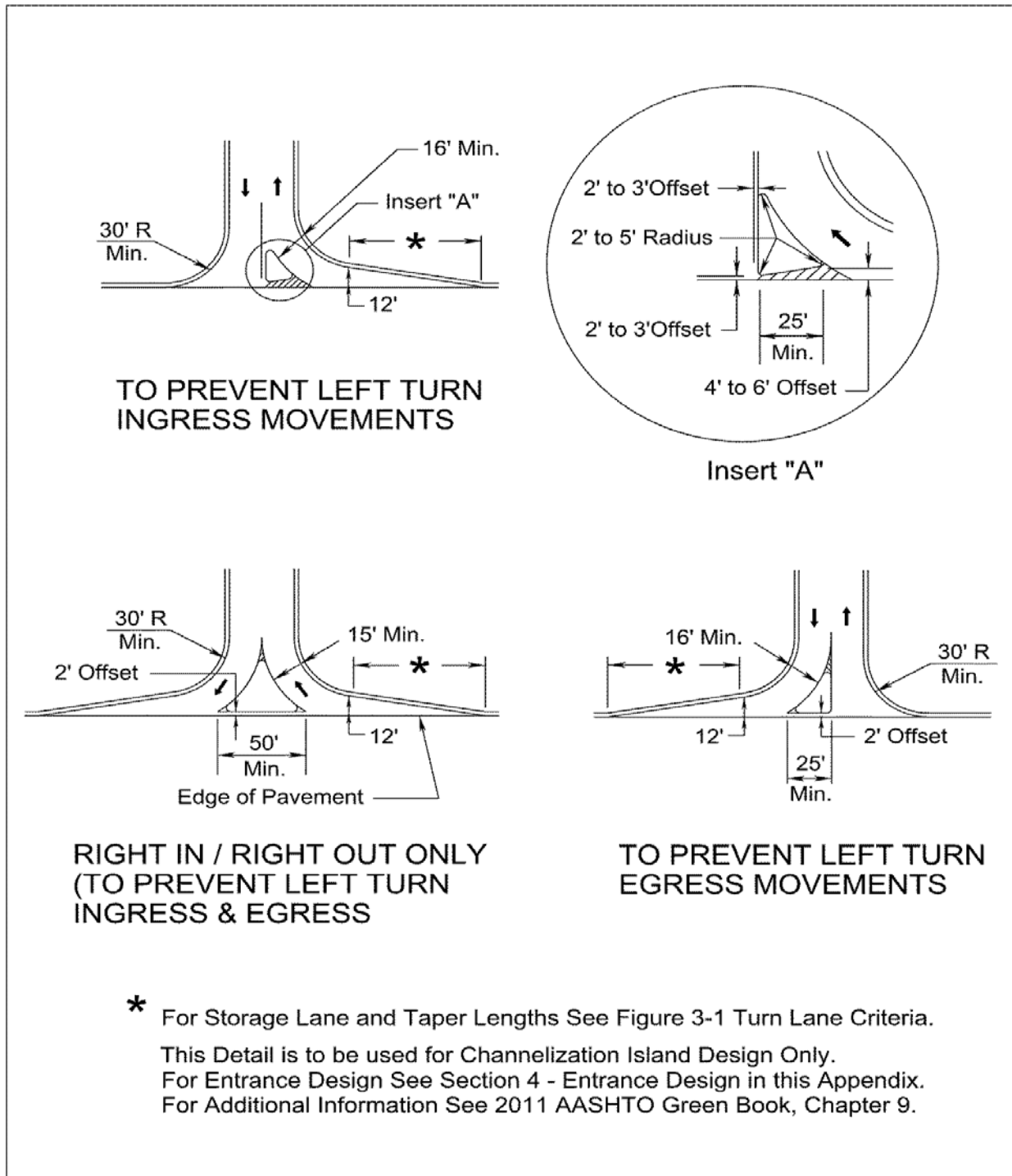

FIGURE 4-4* COMMERCIAL ENTRANCE CHANNELIZATION ISLAND OPTIONS

* Rev. 1/14

Commercial Entrance Spacing

Access management increases the spacing between entrances, thus reducing the number and variety of events to which drivers along the corridor must respond. Close spacing between unsignalized entrances forces the driver to watch for ingress and egress traffic at several locations simultaneously. Increased spacing translates into fewer accidents, savings in travel time, and preservation of corridor capacity.

Entrances shall be located to limit interference with the free movement of roadway traffic, and to provide the most favorable sight distance and entrance grade. No direct access entrance shall be located in the operational area of a signalized intersection. Commercial entrance separation is required by the Access Management Regulations 24VAC30-73-120 using the spacing standards in Table 2-2.

Corner Clearance on a Minor Side Street

It is important to think of the operational impacts of entrance placement on side streets where the side streets intersect with major roadways. The major roadway will have the higher functional classification or if the same classification will have the higher traffic volume. Corner clearance does not apply to the intersection of two functionally classified local streets. Corner clearance can, at the discretion of the VDOT reviewer or designer, apply to connections to entrances or private roads that intersect with a VDOT major roadway if: a) the entrance or private road has the appearance of and operates like a street or if it's intersection with the VDOT roadway is signalized and b) the connection to the entrance or private road may impact the operation of the entrance or private road's intersection with the VDOT roadway. * The operational character of the traffic turning from the main roadway onto the minor side street as well as the expected queues on the side street, help determine how far to place the closest side street entrance from the intersection.

Moving the basic entrance conflict area away from the vicinity of an intersection can be accomplished by regulating the distance between a crossroad intersection and the nearest entrance location. The intent is to prevent queued vehicles from backing up into the highway or blocking entrances near the intersection. The major effect is that vehicles will be delayed less by standing queues at signalized intersections.

Corner clearance is defined as the distance, measured perpendicular to the major roadway, from the nearest edge of an entrance on the minor side street to the nearest edge pavement of the major roadway intersection.

In most instances, the minimum corner clearance will be governed by the intersection sight distance. Minimum entrance setbacks should be considered at individual intersections, and should be based on typical queue lengths that still allow sufficient movement to and from an entrance.

* Rev. 7/17

It is important to note that the Table 2-2 entrance and intersection spacing standards are measured from the centerlines of the intersection and the entrance rather than edge of pavement. As a result, the Table 2-2 spacing measurement may result in a distance that is less than the corner clearance. The corner clearance distance will apply where it is greater than the Table 2-2 spacing standard to protect intersection operation.

Similar to the placement of an entrance on the main roadway, conflicts for the existing vehicles for the side street entrance must be considered. Figure 4-5 illustrates the concept of corner clearance.

For the right turn out of the side street entrance (flow A), the vehicle approaching from the left (flow C) must be considered. The greater the radius (R) for right turning vehicles from the main roadway, the faster they will be approaching the side street entrance. For the driver exiting the side street entrance to go left (flow B) or right (Flow F) or to enter the opposite entrance (Flow E), the length of the queue at the main intersection must be considered to assure there is enough room that the entrance will not be blocked by queue D.

The downstream corner clearance is 225' minimum*, which equals the intersection sight distance for 20 mph (see Table 2-5). Additional length will be required as directed by the Engineer at the Residency or District.

The minimum upstream corner clearance is the greater of 225' + W or the queue D.

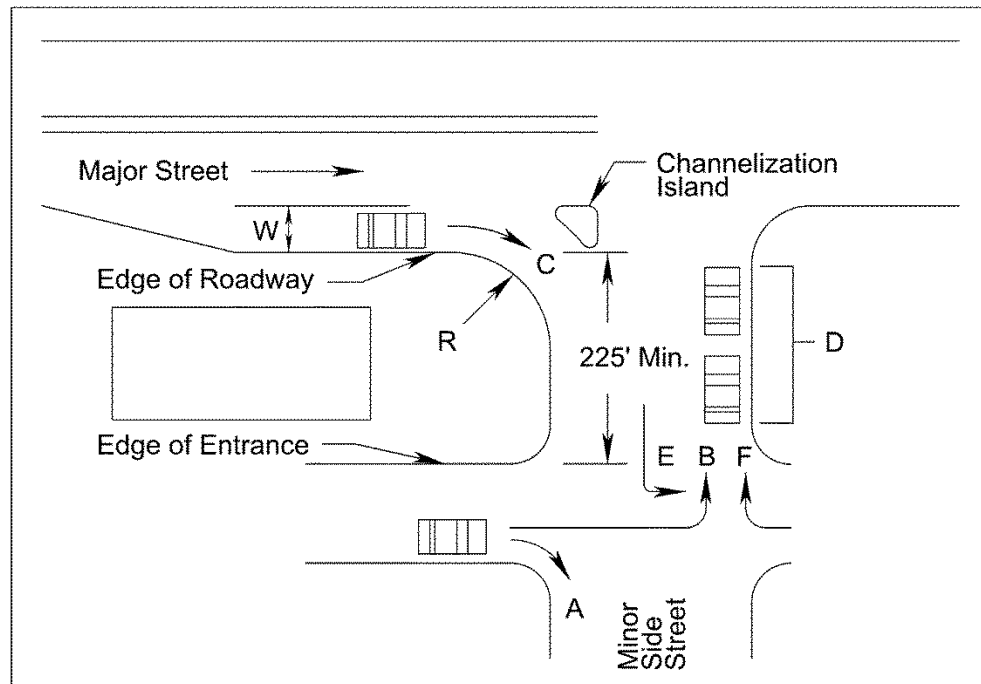
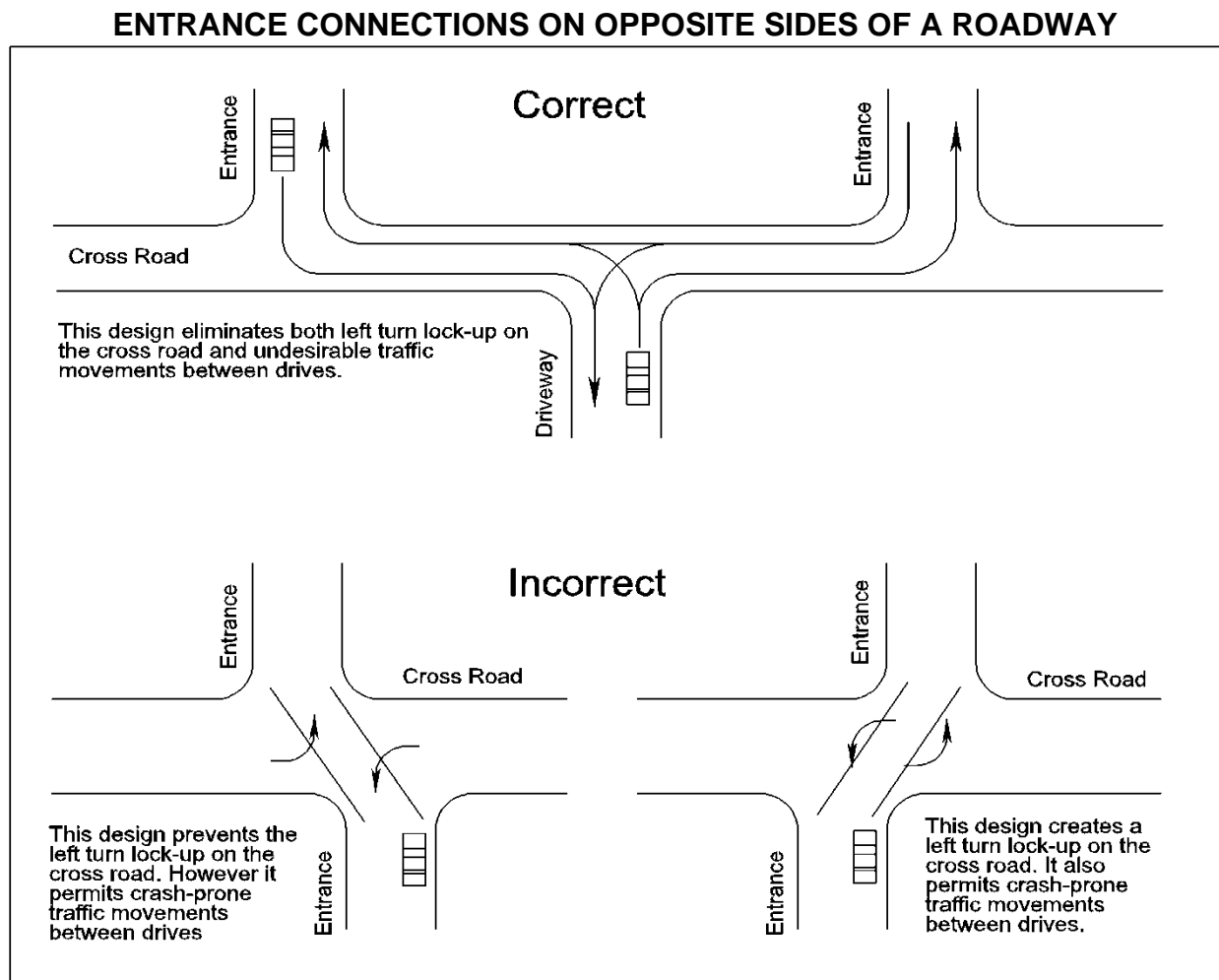

FIGURE 4-5 CORNER CLEARANCE

* Rev. 7/17

Entrance Connections on Opposite Sides of a Roadway

Closely spaced entrances on opposite sides of an undivided roadway or a roadway with two-way left-turn lanes (TWLTL) result in “jog” maneuvers, instead of separate and distinct left-turn and right-turn maneuvers (see below). They can also result in conflicting left-turns. Unless entrances are directly across from each other creating a 4 way intersection that meets Table 2-2 intersection spacing, entrances on opposite sides of a roadway shall be offset to ensure that entrance left turning movements do not conflict, see Figure 3-1 for turn lane and taper criteria. Separation of the access connections results in their functioning as separate T-intersections (3-way intersection) that have relatively low crash potential.



Source: Driveway Handbook, dated March 2005, Florida Dept. of Transportation.

FIGURE 4-6 ENTRANCE CONNECTIONS ON OPPOSITE SIDES OF A ROADWAY

Entrance Consolidation (Shared Use Entrances)

Shared use entrances are used to reduce the number of access points along a corridor while maintaining reasonable access to adjacent land uses. A shared use entrance generally serves only two parcels. The Access Management Regulations 24VAC30-73-120 requires shared entrances where possible.

A shared use entrance may be constructed if both property owners abutting a common property line agree. This encourages adjacent property owners to construct shared entrances in lieu of separate ones. Strategies for implementing this access control measure include closing existing entrances or authorizing joint-use ones. The feasibility of this measure should be viewed at the preliminary, site plan review and the permit-authorization stages. A shared entrance will result in a reduction in the concentration of entrances along a roadway, thus reducing the frequency and severity of conflicts.

The physical means by which access can be consolidated between two adjacent properties involves the construction of a joint-use entrance between the two properties. It is recommended that both property owners own the shared access drive. That is, the entrance should straddle the property line dividing the two establishments. The resulting joint-use parking area should be accompanied by an efficient internal circulation plan.

Interparcel Vehicular Connections

By establishing vehicular circulation connections between parcels (land uses), the driver needing to turn left across heavy volumes can usually find an access that is signalized, allowing safer left turns.

Having good cross parcel access also maximizes the number of well designed unsignalized entrances that have good visibility and are located in such a way to take advantage of sufficient gaps in traffic from a nearby signal.

Interparcel connections allow the driver to travel to an adjacent land use(s) without having to access the highway. Joint entrances and cross access especially help the small corner lots and out parcels. On small corner parcels left turn accessibility may be a problem and access to parcels may be limited to right in/right out or similarly restricted movements.

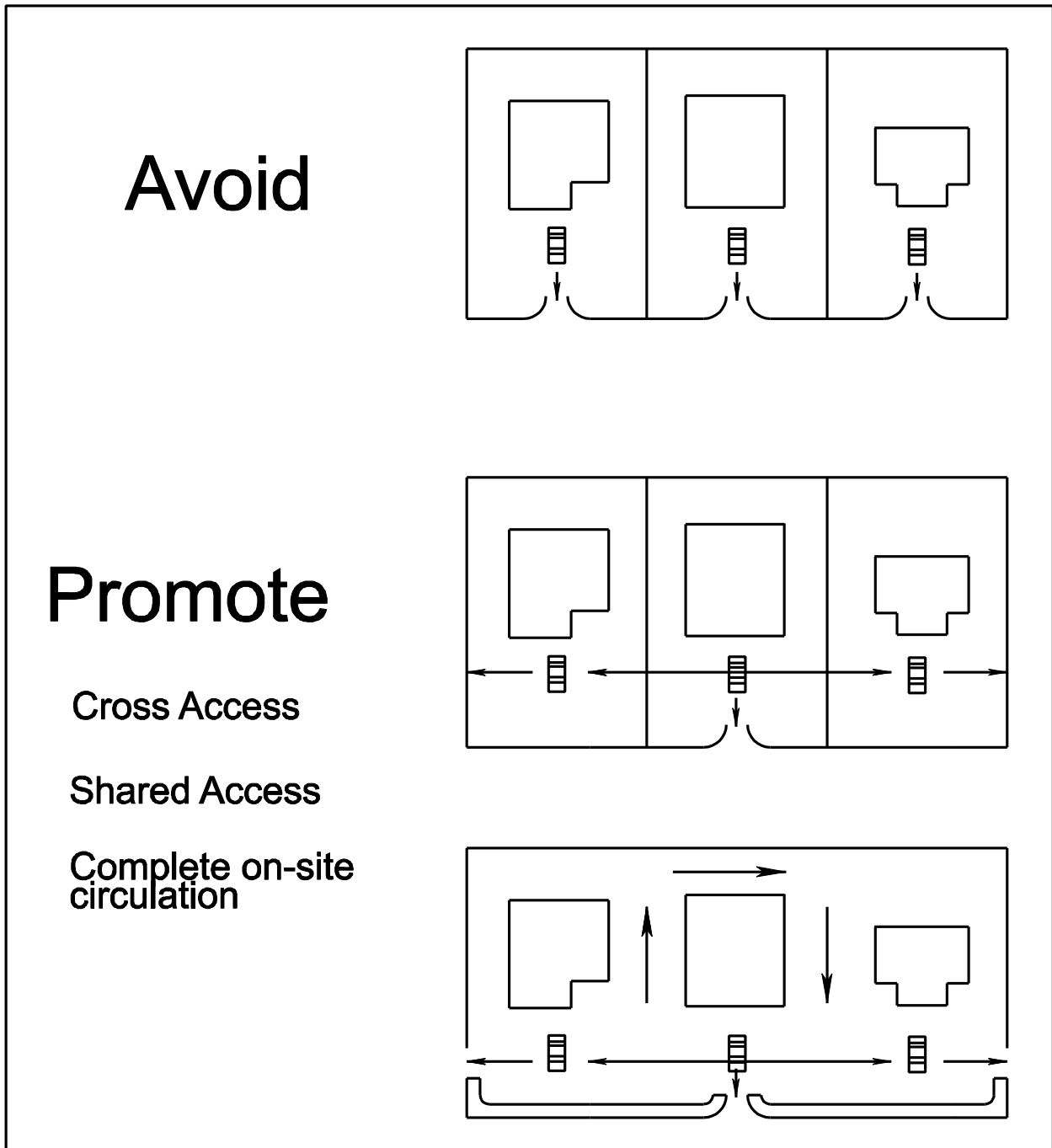

Source: FDOT- Driveway Handbook, Dated March, 2005

FIGURE 4-7 SHARED ENTRANCE AND INTERNAL SITE CONNECTION

Frontage Roads

Frontage or service roads may be constructed by VDOT where justified by existing or anticipated traffic needs, right-of-way requirements, etc. within funds available.

Where frontage or service roads have not been constructed by VDOT, the Department may cooperate with others in the construction of service roads to promote highway safety and provide suitable locations for public utility services.

VDOT may furnish assistance if the construction of a frontage road will provide significant public service and eliminate undesirable ingress and egress through the establishment of safe and properly spaced access points.

Frontage roads constructed in cities, municipalities, or towns of more than 3,500 or along Primary routes in those counties which maintain their Secondary roads shall meet all minimum VDOT standards or the standards of the city, town or county as provided by ordinance.

When frontage or service roads are constructed by someone other than VDOT, the following conditions shall apply:

If the road is Constructed on...	Then the construction Must...	And...
Existing State Right-of-Way	Conform to such rules regulations, standards, specifications, and plans as may be approved by VDOT and authorized by issue of a permit	The cost of the construction is fully borne by others.
Land Outside Existing State Right-of-Way	Conform to such rules, regulations, standards, specifications, and plans, as may be approved by VDOT	The land must be dedicated to public use if the road is to be accepted into the highway system and maintained by VDOT.
Then...	VDOT will accept as a part of the appropriate highway system, those service roads constructed by others in accordance with above criteria.	

VDOT will maintain the roads in accordance with maintenance standards established for such classes of roads.

The cost of maintaining frontage roads shall be charged to the route and section of mainline highway which it serves unless it forms an integral section of another route.

Source: Code of Virginia, [15.2-2265](#) and [33.2-404](#)*

* Rev. 10/14

Entrances Affected by Highway Construction Projects

Title [33.2-1001](#)* of the Code of Virginia, as amended, requires that projects have the alignment, profile, and grade of commercial and private entrances shown on plans.

This information is to be shown as follows:

1. When the proposed entrance is to be placed in the same location as the existing entrance, no alignment will be shown. The proposed entrance will be shown graphically. A note is to be included on the general notes sheet as follows: "When no baseline alignment is shown for a proposed entrance, the entrance is to be constructed in the same location as the existing entrance."
2. Where a proposed entrance is to be on a location different from the existing, the proposed location will be shown graphically on the field inspection plans. After the field inspection party has reviewed the proposed location, the Right of Way and Utilities Division will contract the property owner and determine that the proposed location is satisfactory or that the property owner desires some other location. The Engineer will then request the centerline and profile to be run by the survey party when this cannot be secured from existing notes. This alignment is to be shown on the plans.
3. A profile and proposed grade is to be shown for each entrance where it is necessary to re-grade on existing or new location. The survey party runs a profile along every existing entrance using a data collector and converting the information for placement into a graphics file. The profile is generally run along the center of the existing entrance, although usually no alignment is taken. The proposed grade can be a spline grade with an approximate percent of grade shown. The proposed grade will begin at the edge of shoulder; back of curb; or back of sidewalk, sidewalk space, or bikeway whichever is the outermost permanent construction. If it is necessary to use some other beginning point, it should be identified on the profile.

It is desirable that projects with a large number of entrances contain a separate profile sheet or sheets devoted to entrances.

4. The above information does not apply to "No Plan" Projects.

Title [33.2-242](#) of the Code of Virginia, Replacing entrances destroyed by Commissioner. The Commonwealth Transportation Commissioner shall review the existing access to any parcel of land having an entrance destroyed in the repair or construction of the systems of state highways and shall provide access to the systems of state highways in a manner that will serve the parcel of land and ensure efficient and safe highway operation.

* Rev. 10/14

1. Whenever plans have been prepared for a proposed improvement and submitted to the district for field inspection, the plans will show the entrances in place as called for by the engineering information at the time the plans were prepared. The field inspection team shall make a close inspection of all entrances on the project and a determination will be made as to which entrances are to be replaced based on the entrance spacing standards in Table 2-2, 2-3, or 2-4 in order to protect the safety, integrity, and operational characteristics of the highway.
2. In reviewing the plans, there may be instances where a landowner now has access to his property by reason of the fact that he is able to drive from the highway surface to this adjoining property, particularly in farming operations, in order to obtain access to various fields within the farm. This must be carefully studied and, if the farm is so arranged that this is found to be true, the provisions are to be made to provide field entrances as conditions would require.
3. No additional entrances are to be called for or shown on the plans and certain entrances may need to be consolidated or relocated.
4. The right of way is to be appraised and acquired in accordance with the approved plans and the entrances that are shown thereon. (Should it be discovered at the appraising or negotiating stage that an existing entrance has been overlooked or added by the owner since the time of field inspection, then, of course, this entrance will be replaced.) There will, of course, be instances when the owner requests the construction of an entrance to a property where no access exists or for the construction of an additional entrance. When this occurs, the owner's request can be complied with if it is determined that construction of the entrance is economically justified and the District Engineer/Administrator and responsible District* Traffic Engineer give their approval for the construction thereof.
5. The type of entrance (Type I, II, III, IV) to be constructed will be determined by the existing conditions at the time of construction. The applicable details shown as CADD Cell "PCENTR" are to be placed on the typical section sheet, see http://www.virginiadot.org/business/locdes/vdot_cadd_manual.asp.
6. For exceptions or waivers to spacing standards or other entrance criteria on highway construction projects, please see pages F-30 and F-31 of this Appendix.

* Rev. 1/17

Commercial Entrance Designs along Highways with Shoulders

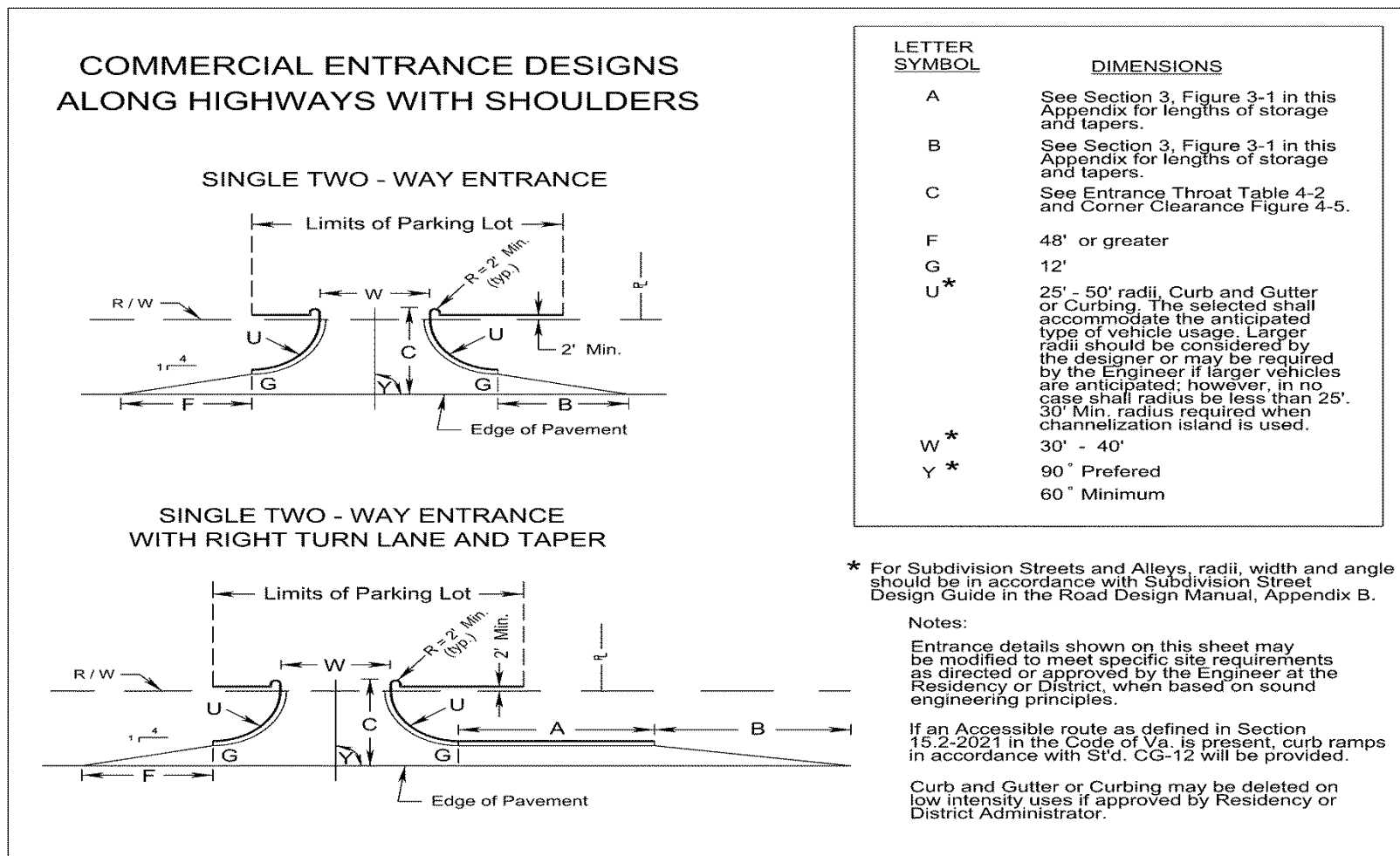

FIGURE 4- 9 COMMERCIAL ENTRANCE DESIGNS ALONG HIGHWAYS WITH SHOULDERS*

Note: All entrance design and construction shall accommodate pedestrian and bicycle users of the highway in accordance with the Commonwealth Transportation Board's "Policy for Integrating Bicycle and Pedestrian Accommodations".

* Rev. 1/16

Commercial Entrance Designs along Highways with Curb and Gutter

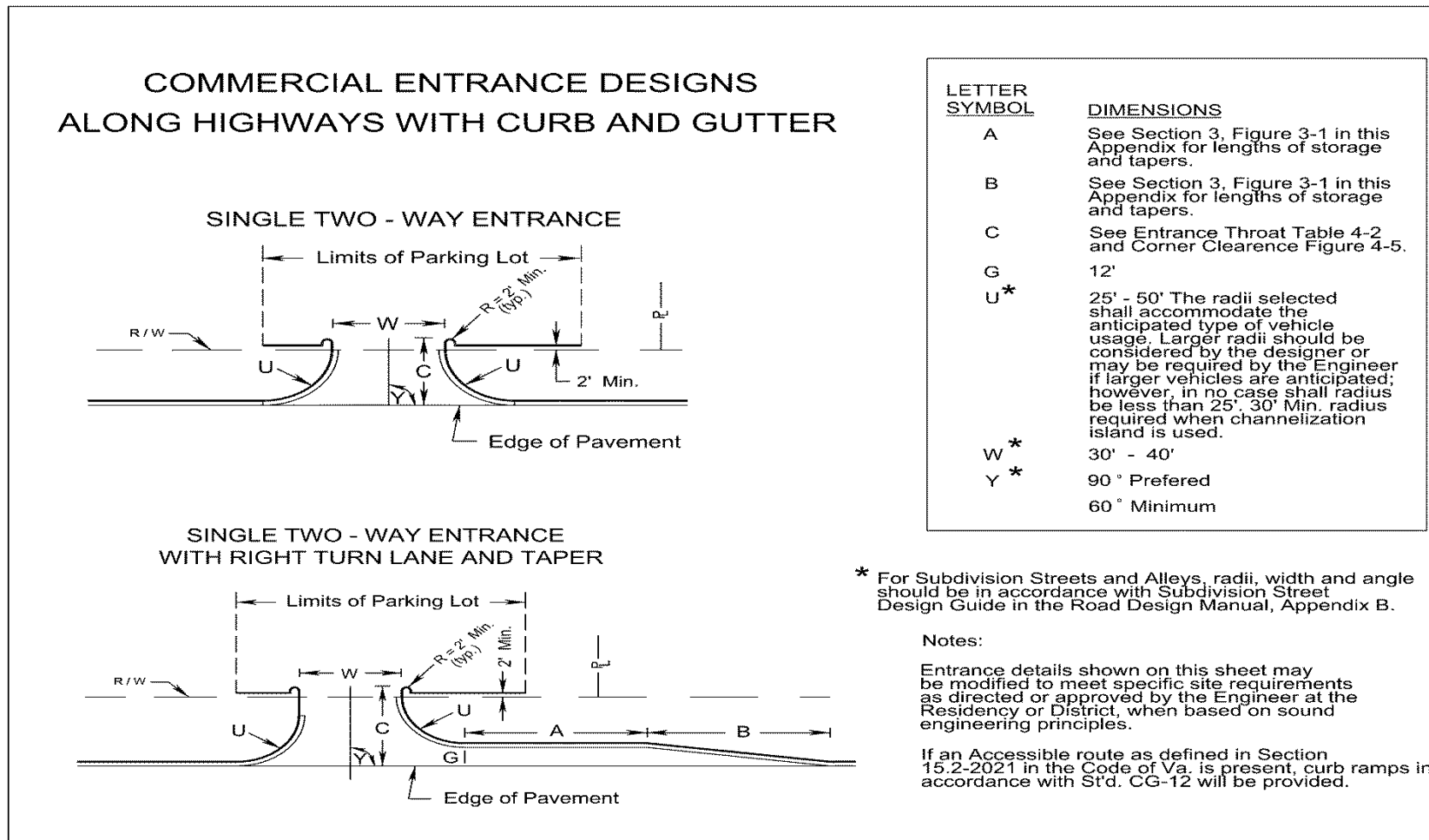

FIGURE 4-10 COMMERCIAL ENTRANCE DESIGNS ALONG HIGHWAYS WITH CURB AND GUTTER*

Note: All entrance design and construction shall accommodate pedestrian and bicycle users of the highway in accordance with the Commonwealth Transportation Board's "Policy for Integrating Bicycle and Pedestrian Accommodations".

* Rev. 1/16

Commercial Entrance Design along Local Streets with Curb and Gutter or Shoulders

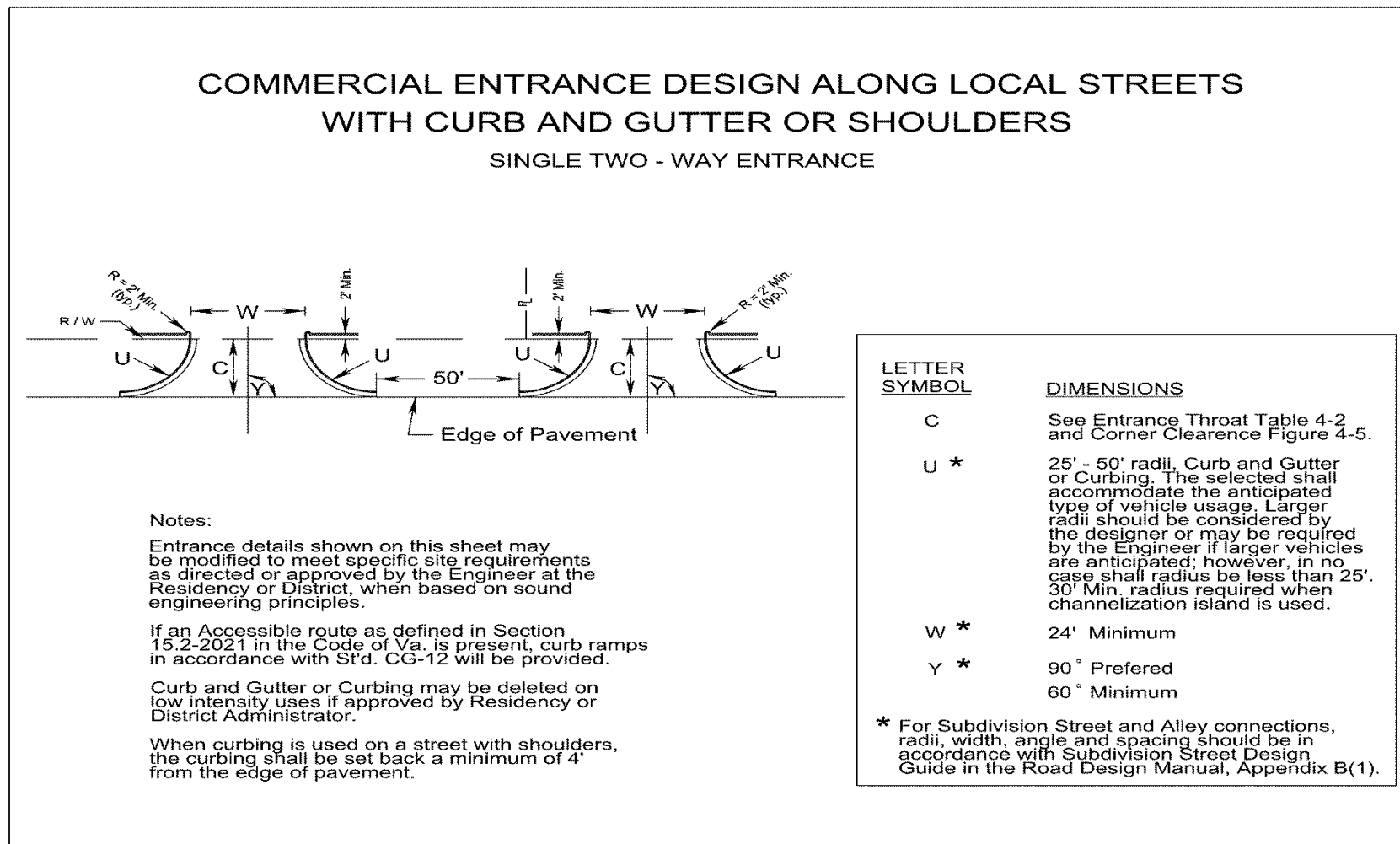

FIGURE 4-11 COMMERCIAL ENTRANCE DESIGNS ALONG LOCAL STREETS*

Note: All entrance design and construction shall accommodate pedestrian and bicycle users of the highway in accordance with the Commonwealth Transportation Board's "Policy for Integrating Bicycle and Pedestrian Accommodations".

* Rev. 7/12

Commercial Entrance Designs along Highways with Shoulders at Intersection

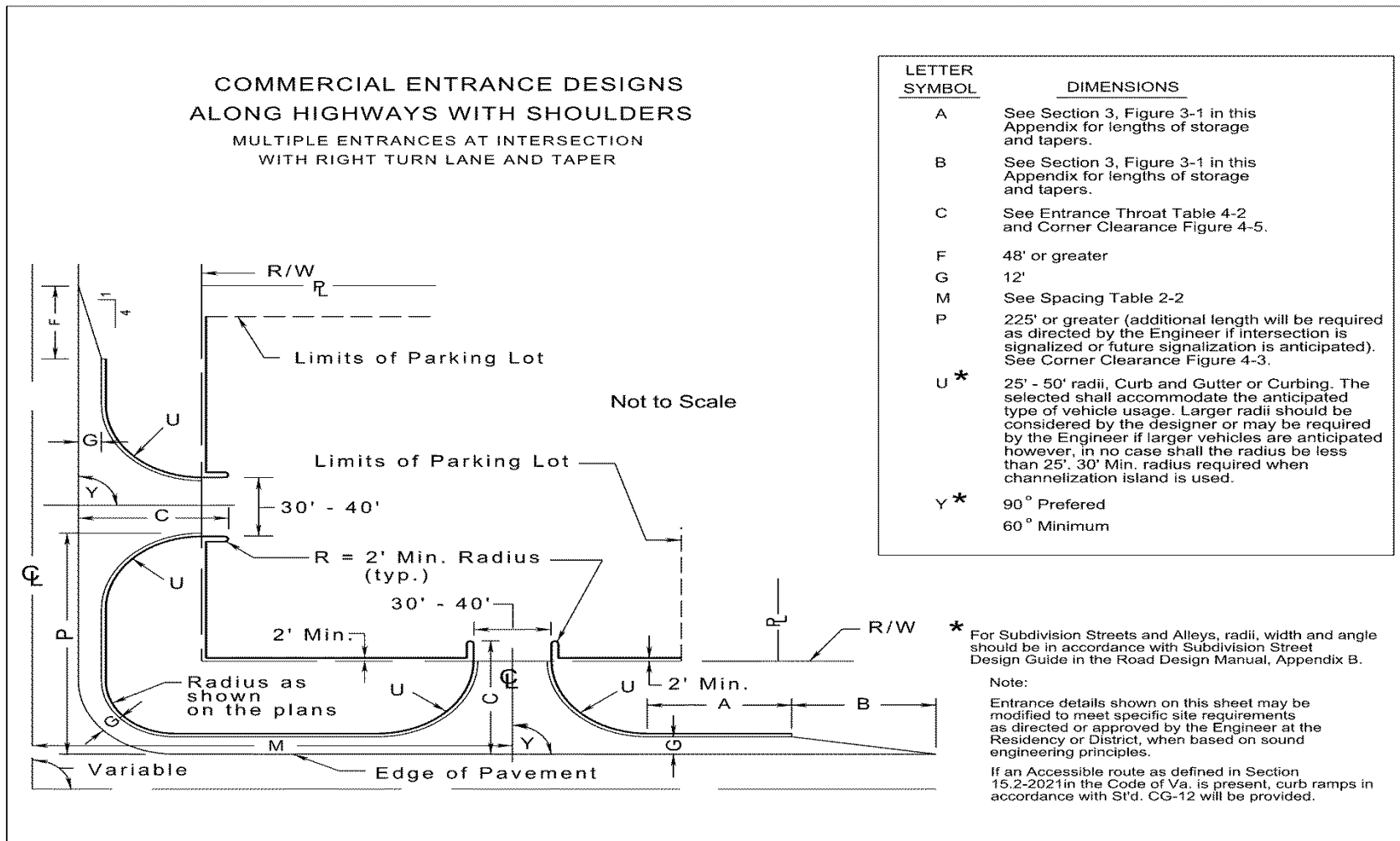

FIGURE 4-12 COMMERCIAL ENTRANCE DESIGNS ALONG HIGHWAYS WITH SHOULDERS AT INTERSECTION*

Note: All entrance design and construction shall accommodate pedestrian and bicycle users of the highway in accordance with the Commonwealth Transportation Board's "Policy for Integrating Bicycle and Pedestrian Accommodations".

* Rev. 1/16

Commercial Entrance Designs along Highways with Curb and Gutter at Intersection

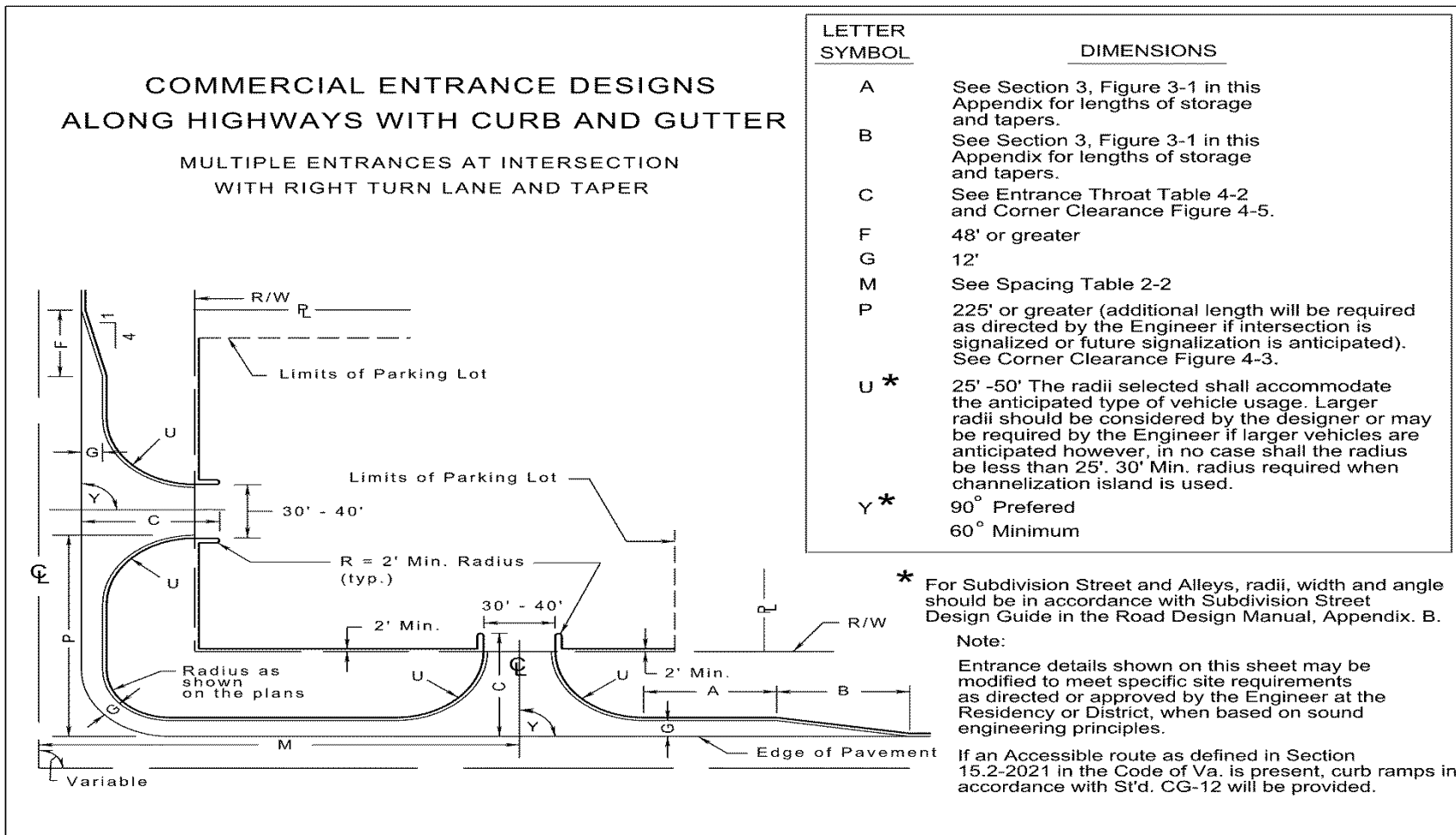

FIGURE 4-13 COMMERCIAL ENTRANCE DESIGNS ALONG HIGHWAYS WITH CURB & GUTTER AT INTERSECTION*

Note: All entrance design and construction shall accommodate pedestrian and bicycle users of the highway in accordance with the Commonwealth Transportation Board's "Policy for Integrating Bicycle and Pedestrian Accommodations"

* Rev. 1/16

Commercial Entrance Designs to Serve Drive-In Type Businesses

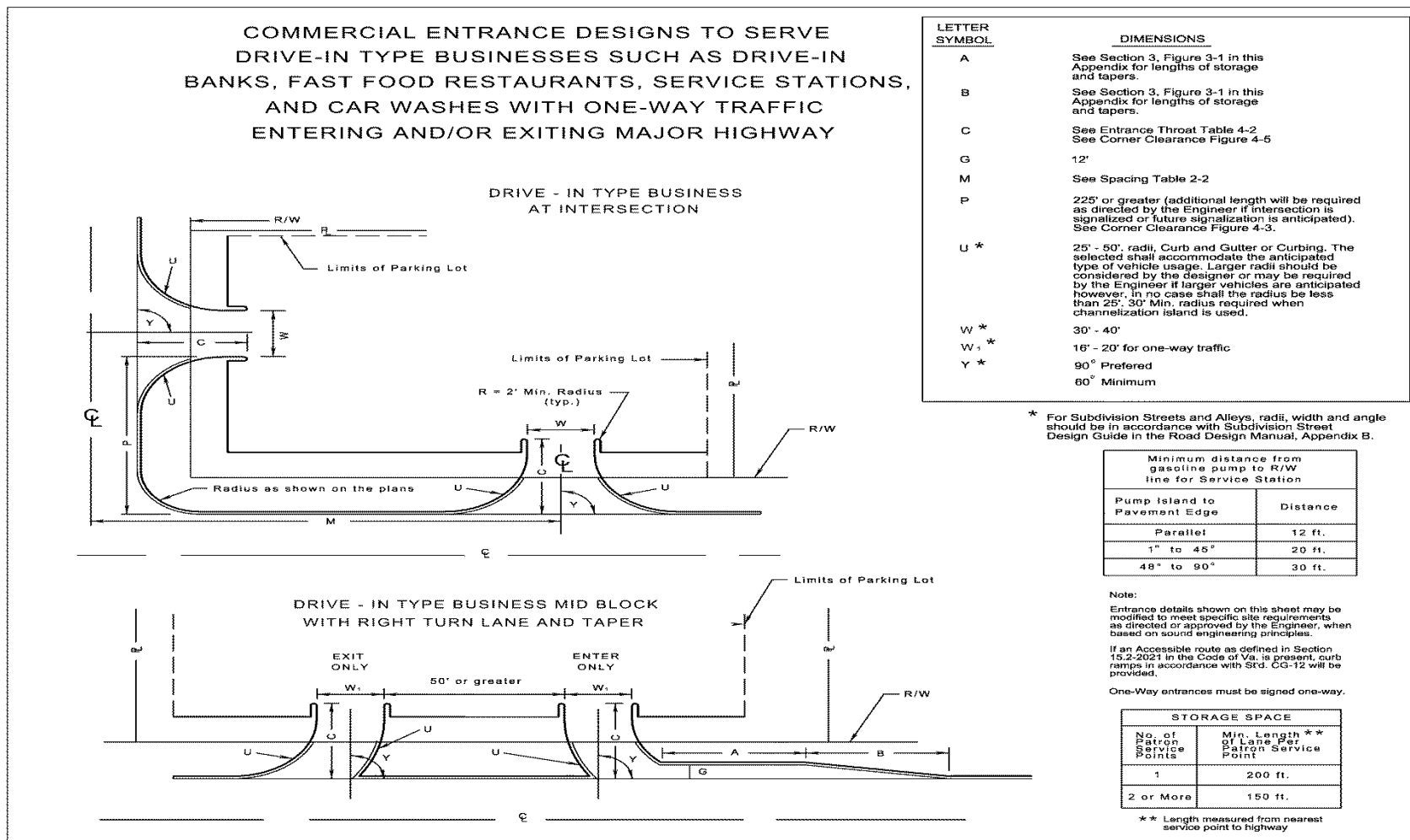

FIGURE 4-14 COMMERCIAL ENTRANCE DESIGNS TO SERVE DRIVE-IN TYPE BUSINESSES *

Note: All entrance design and construction shall accommodate pedestrian and bicycle users of the highway in accordance with the Commonwealth Transportation Board's "Policy for Integrating Bicycle and Pedestrian Accommodations".

* Rev. 1/16

Moderate Volume Commercial Entrance Design along Highways with Shoulders

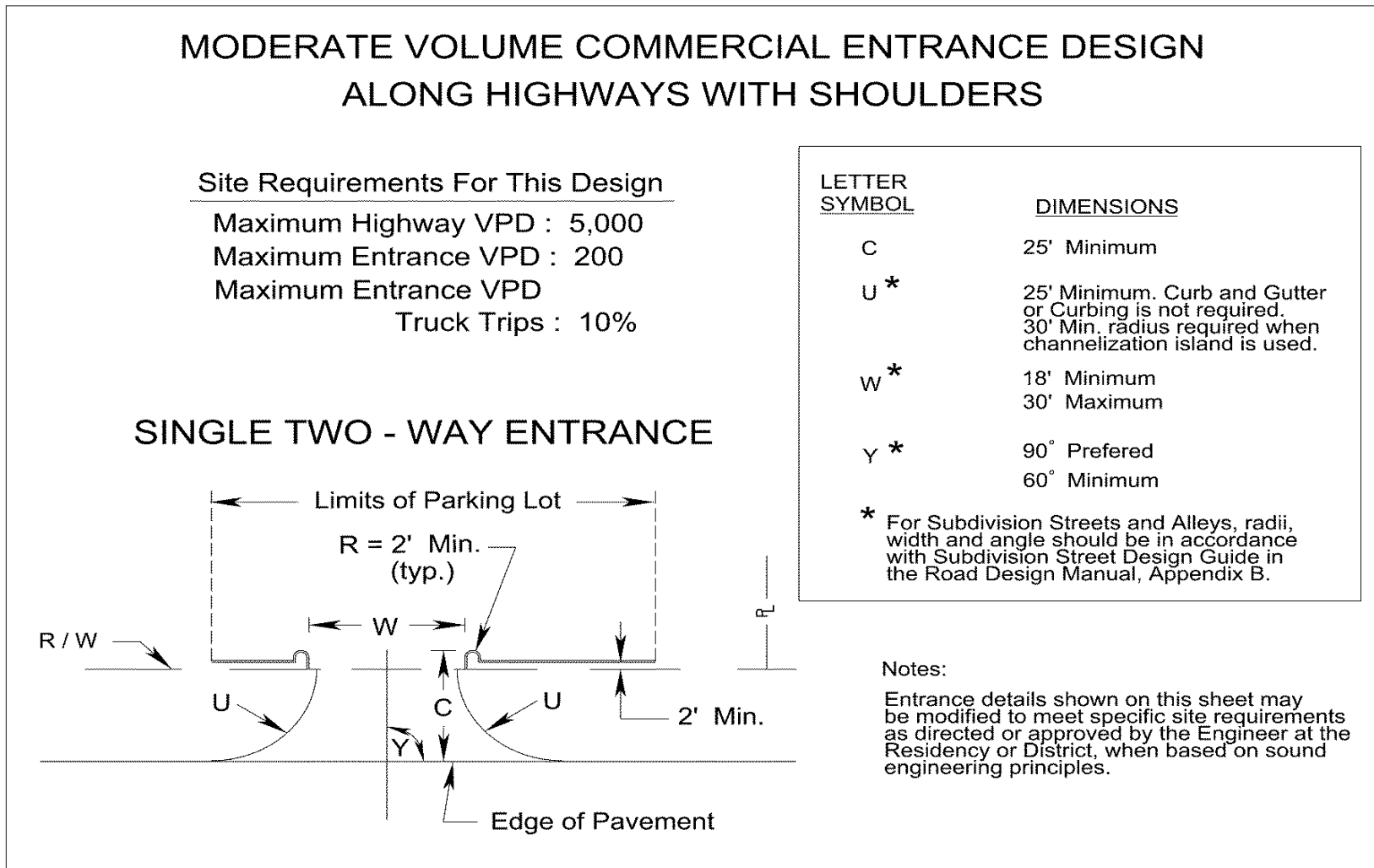

FIGURE 4-15 MODERATE VOLUME COMMERCIAL ENTRANCE DESIGN ALONG HIGHWAYS WITH SHOULDERS*

Note: All entrance design and construction shall accommodate pedestrian and bicycle users of the highway in accordance with the Commonwealth Transportation Board's "Policy for Integrating Bicycle and Pedestrian Accommodations".

* Rev. 7/12

Agritourism Entrance Standards

Moderate Volume Commercial Entrance may be permitted by the Engineer at the Residency or District if the proposed use includes agritourism activity as defined in Code of Virginia [§3.2-6400](#). Entrance design shall include U of 50' minimum and W of 30' minimum to accommodate BUS-45 ingress and egress movements. Entrances shall be located to provide adequate intersection sight distance.

Code of Va. [§3.2-6400](#) defines an "agritourism activity" as "any activity carried out on a farm or ranch that allows members of the general public, for recreational, entertainment, or educational purposes, to view or enjoy rural activities, including farming, wineries, ranching, historical, cultural, harvest-your-own activities, or natural activities and attractions."*

* Added 7/17

BIBLIOGRAPHY

American Association of State Highway and Transportation Officials (AASHTO), *A Policy on Geometric Design of Highways and Streets*, Washington, D.C. Dated 2011*.

Transportation Research Board (TRB), National Research Council, *Urban Street Symposium*, Circular E-C019, Dated December 2000.

Transportation Research Board (TRB), National Research Council, Transportation *Research Circular Urban Street Symposium Conference* Proceedings, Dated June 28-30, 1999.

Transportation Research Board of The National Academies, *Access Management Manual*, Dated 2003.

Transportation Research Board (TRB), National Research Council, *National Cooperative Highway Research Program, NCHRP Report 348, Access Management Guidelines for Activity Centers*, Dated 1992.

Transportation Research Board (TRB), National Research Council, *Transportation Research Record, No. 1385, Highway and Facility Design, Intersection and Interchange Design*, Dated 1993.

Institute of Transportation Engineers (ITE), *Guidelines For Urban Major Street Design*, Dated 1984.

Institute of Transportation Engineers (ITE), *Sidewalk Design Guideline and Existing Practices, Part 1*, Dated July 1999.

Institute of Transportation Engineers (ITE), Issue Briefs 13, *Access Management: A Key to Safety and Mobility*, Dated April 2004.

Oregon department of Transportation (ODOT), *Right-In Right-Out Channelization*, Dated October 4-7, 1998.

Iowa Department of Transportation (IDOT), *Design Manual, Chapter 5 Roadway Design 51-Access Management*, Dated October 17, 2006.

Fulton County Driveway Manual (Georgia), Adopted May 2005.

New Mexico State Highway and Transportation Department, *State Access Management Manual*, Dated September 20, 2001.

* Rev. 7/12

Florida Department of Transportation (FDOT), System Planning Office, Driveway Handbook, Dated March 2005.

Florida Department of Transportation (FDOT), Florida Intersection Design Guide, Dated 2002.

Florida Department of Transportation (FDOT), Rules of the Department of Transportation, Chapter 14-97, State Highway System Access Management Classification System and Standards, November 27, 1990.

Florida Department of Transportation (FDOT), Manual of Uniform Minimum Standards for Design, Construction and Maintenance for Streets and Highways (Topic #625-000-025), Dated July 20, 2006.

Michigan Department of Transportation (MDOT), The Access Management Guidebook, Date Unknown (After 2000).

Transportation Research Board (TRB), National Research Council, Transportation Research Circular No. 456 Driveway and Street Intersection Spacing, Dated March 1996.

Transportation Research Board (TRB), National Research Council, National Cooperative Highway Research Program, NCHRP Report 420, Impacts of Access Management Techniques, Dated 1999.

Transportation Research Board (TRB), National Research Council, National Cooperative Highway Research Program, NCHRP Report 383, Intersection Sight Distance, Dated 1996.

New Jersey Department of Transportation (NJDOT), Roadway Design Manual, Section 6 at-Grade Intersections, Date Unknown.

Fourth National Access Management Conference, An Introduction To Access Management, Dated August 2000.

FHWA Functional Classification Guidelines, Concepts, Criteria and Procedures, Dated 1999.

Kentucky Transportation Cabinet, Highway Design, Dated January 2006.

Nashua Regional Planning Commission (New Hampshire), Access Management Guidelines, Dates April 2002.

Illinois Department of Transportation (IDOT), Bureau of Design and Environment Manual, Dated December 2002.

Institute of Transportation Engineers (ITE), Technical Committee 5B-13, Institute of Transportation Engineers, Guideline for Driveway Design and Location, Dated 1985.

Federal Highway Administration (FHWA), National Highway Institute, Access Management, NHI Course No. 15255, Dated October 1991.

Massachusetts Highway Department, Project Development and Design Guide, Dated 2006.

Maryland State Highway Administration, Managing Highway Access, Dated January 2001.

North Carolina Department of Transportation, Strategic Highway Corridors, Dated Unknown.

South Dakota Department of Transportation, Road Design Manual, Dated 1997.