

## APPENDIX A

### SECTION A-1-GEOMETRIC DESIGN STANDARDS

Introduction .....	A-1
Flexibility In Design .....	A-1
Secondary Project Improvements .....	A-2
Roadway Width .....	A-3
Design Speed (V).....	A-3
Operating Speed .....	A-7
Posted Speed.....	A-7
Design Vehicle .....	A-8
Design Waivers .....	A-8
Design Exceptions.....	A-9
Functional Classification.....	A-9
Lane/Shoulder/Pavement Transitions, Merging Tapers & Speed Change Lengths .....	A-11
Geometric Design Standards For Rural Principal Arterial System (GS-1).....	A-12
Geometric Design Standards For Rural Minor Arterial System (GS-2).....	A-13
Geometric Design Standards For Rural Collector Road System (GS-3) .....	A-14
Geometric Design Standards For Rural Local Road System (GS-4).....	A-15
Geometric Design Standards For Urban Principal Arterial System (GS-5).....	A-16
Geometric Design Standards For Urban Minor Arterial Street System (GS-6).....	A-17
Geometric Design Standards For Urban Collector Street System (GS-7) .....	A-18
Geometric Design Standards For Urban Local Street System (GS-8) .....	A-19
Geometric Design Standards For Service Roads (GS-9).....	A-20
Geometric Design Standards For Interchange Ramps (GS-R) .....	A-21
Geometric Design Standards For Temporary Diversion (GS-10) .....	A-22
Geometric Design Standards For Shoulder Design (GS-11).....	A-23
Geometric Design Standards For Shoulder Design For Local Road and Streets (GS-12) ...	A-24
Geometric Design Standards For Graded Median Design (GS-13) .....	A-25

### SECTION A-2-CLEAR ZONE/LATERAL OFFSET GUIDELINES

Introduction .....	A-26
Roadways With Shoulders .....	A-26
Roadways With Curb.....	A-27
Clear Zone Cost-Effectiveness Analysis .....	A-31
Embankment Slopes .....	A-32
Horizontal Curve Adjustments.....	A-33
Showing Clear Zones/ Lateral Offsets On Typical Sections .....	A-34
Non-Recoverable Parallel Slopes .....	A-36

**SECTION A-3- INNOVATIVE INTERSECTION AND INTERCHANGE DESIGN GUIDELINES**

Current VDOT Innovative Intersection and Interchange Control Types..... A-38  
Innovative Intersection Design Guidelines ..... A-39  
Displaced Left-Turn Intersection (DLT) ..... A-39  
Median U-Turn Intersection (MUT)..... A-40  
Restricted Crossing U-Turn Intersection (RCUT) ..... A-41  
Continuous Green-T (CGT) ..... A-42  
Quadrant Roadway Intersection (QR) ..... A-43  
Quadrant Roadway Intersection ..... A-44  
Jug-Handle ..... A-45  
Roundabouts ..... A-46  
Mini-Roundabouts ..... A-49  
Single-Lane Roundabouts ..... A-51  
Multi-Lane Roundabouts ..... A-52  
Geometric Design Criteria For Single-Lane and Multi-Lane Roundabouts ..... A-53  
Bicycle and Pedestrian Accommodations ..... A-56  
Design Resources ..... A-57  
The Review and Approval Process For Roundabouts ..... A-57  
Innovative Interchange Design Guidelines ..... A-59  
Diverging Diamond Interchange (DDI) ..... A-60  
Single Point Urban Interchange (SPUI) ..... A-78  
Double Roundabout Interchange ..... A-79

**SECTION A-4-GUIDELINES FOR RRR PROJECTS**

Objective ..... A-80  
Authority ..... A-81  
Definitions ..... A-81  
Project Selection ..... A-82  
Eligibility ..... A-82  
Accident Records ..... A-83  
Bridge Rehabilitation or Replacement Selection Policy ..... A-83  
Environmental Considerations ..... A-84  
Access Control ..... A-84  
Project Development ..... A-84  
Roadway and Travelway Widths ..... A-84  
Design Traffic Volumes ..... A-85  
Design Speed ..... A-85  
Terrain ..... A-86  
Safety ..... A-86  
Geometric Design Criteria ..... A-89  
Clear Zones and Slopes ..... A-90  
Grades ..... A-90  
Crest Vertical Curves ..... A-90  
Sag Vertical Curves ..... A-90  
Stopping Sight Distances ..... A-91  
Horizontal Curves ..... A-91  
Pavement Cross Slope ..... A-92  
Superelevation Requirements ..... A-92  
Pavement Edge Drop ..... A-92

Intersections.....	A-92
Design Exceptions.....	A-93
Planning Drainage Design Elements.....	A-93
Replacement or Rehabilitation of Drainage Elements.....	A-93
Hydraulic Characteristics.....	A-94
Safety Improvements Relative To Drainage Design.....	A-95
Bridge Restoration.....	A-95
Bridge Rehabilitation.....	A-95
Culvert Replacement.....	A-96
Culvert Rehabilitation.....	A-96
Culvert Extensions.....	A-97
Signing, Signals and Pavement Markings.....	A-97
Plan Reviews.....	A-97
Public Involvement.....	A-98
Right of Way.....	A-98
Utilities (Underground and Overhead).....	A-98
Tort Liability and Geometric Design.....	A-98
Background On Tort Liability.....	A-99
Rrr Improvements and Tort Claims.....	A-99
Susceptibility of RRR Projects and Standards To Tort Claims.....	A-99
Defense of A RRR Project Design.....	A-100
RRR Notes On Project Title Sheet.....	A-101
Preventive Maintenance (PM) Projects/RRR Projects Utilizing Federal Funding On National AHighway System (NHS) Roadways.....	A-101

**SECTION A-5-BICYCLE AND PEDESTRIAN FACILITY GUIDELINES..... A-106**

**SECTION A-6 AIRPORT CLEARANCE REQUIREMENTS..... A-107**

Associated City Public-Use Airport.....	A-109
---	-------

**SECTION A-7-"NO PLAN" AND "MINIMUM PLAN" PROJECTS**

General Concepts.....	A-111
Public Hearing and Right Of Way.....	A-112
Special Design Structures, Soil Survey and Pavement Design.....	A-114
Mobilization and Field Office.....	A-114
Drainage Facilities and Erosion And Sediment Control Measures.....	A-114
VPDES Construction General Permit and Post Construction Stormwater Management:...	A-115
Contract Time Limit.....	A-115
Procedures.....	A-115
Project Scoping Field Review.....	A-115
"No Plan" Projects.....	A-116
"Minimum Plan" Projects.....	A-118
Permits and Reviews ("No Plan" and "Minimum Plan" Projects).....	A-120
Plan Preparation.....	A-120
Specifications.....	A-121
Project Layout.....	A-122
Inspection and Record Keeping.....	A-122

**SECTION A-8-SEQUENCE OF CONSTRUCTION/ TRANSPORTATION MANAGEMENT PLANS (TMP)**

- Introduction ..... A-130
- Sequence of Construction ..... A-133
- Items To Address Under Sequence of Construction: ..... A-134
- Temporary Traffic Control Plans ..... A-136
- Items To Be Addressed Under Maintenance of Traffic Include: ..... A-139
- Notes Which May Be Appropriate On Temporary Traffic Control and Sequence of Construction Plans Include:..... A-145
- Limitation of Operation ..... A-145
- Constructability ..... A-146
- Items To Be Addressed Under Constructability Include: ..... A-147
- References:..... A-148
- Sequence of Construction And Temporary Traffic Control Items To Consider ..... A-149
  - A. Sequence of Construction..... A-149
  - B. Temporary Traffic Control ..... A-150
  - C. Constructability ..... A-151

## LIST OF FIGURES

Figure A-1-1 Geometric Design Standards For Rural Principal Arterial System (GS-1).....	A-12
Figure A-1-2 Geometric Design Standards For Rural Minor Arterial System (GS-2) .....	A-13
Figure A-1-3 Geometric Design Standards For Rural Collector Road System (GS-3).....	A-14
Figure A-1-4 Geometric Design Standards For Rural Local Road System (GS-4).....	A-15
Figure A-1-5 Geometric Design Standards For Urban Principal Arterial System (GS-5) .....	A-16
Figure A-1-6 Geometric Design Standards For Urban Minor Arterial Street System (GS-6).....	A-17
Figure A-1-7 Geometric Design Standards For Urban Collector Street System (GS-7) .....	A-18
Figure A-1-8 Geometric Design Standards For Urban Local Street System (GS-8) .....	A-19
Figure A-1-9 Geometric Design Standards For Service Roads (GS-9).....	A-20
Figure A-1-10 Geometric Design Standards For Interchange Ramps (GS-R) .....	A-21
Figure A-1-11 Geometric Design Standards For Temporary Diversion (GS-10).....	A-22
Figure A-1-12 Geometric Design Standards For Shoulder Design (GS-11).....	A-23
Figure A-1-13 Geometric Design Standards For Shoulder Design For Local Rd. & St's. (GS-12) ..	A-24
Figure A-1-14 Geometric Design Standards For Graded Median Design (GS-13) .....	A-25
Table A-2-1 Clear Zone Distances (In Feet From Edge of Driving Lane).....	A-28
Figure A-2-1 Clear Zone (Lateral Offset) Cases .....	A-29
Figure A-2-1A Clear Zone (Lateral Offset) Cases .....	A-30
Figure A-2-2 Cost Effective Selection Procedures .....	A-32
Table A-2-2 Horizontal Curve Adjustments .....	A-33
Figure A-2-4 Example of A Parallel Embankment Slope Design.....	A-35
Figure A-3-1 Roundabout Design Elements .....	A-47
Figure A-3-2 Roundabout Truck Apron Curb Detail .....	A-48
Table 3-1 Conflict Points .....	A-60
Figure A-3-3 Diverging Diamond Layout .....	A-61
Figure A-3-4 Crossover Geometrics .....	A-66
Figure A-3-5 Offset Distance For Intersection .....	A-67
Figure A-3-6 Shoulder Design For DDI .....	A-67
Figure A-3-7 Diagram Of Expected Oncoming Traffic Versus Actual Oncoming Traffic .....	A-69
Figure A-3-8 Pedestrians Located To Middle of Crossroad Between Crossover .....	A-72
Figure A-3-9 Pedestrians Located To Outside .....	A-73
Table A-4-1 Geometric Design Criteria .....	A-89

## APPENDIX A

### SECTION A-1-GEOMETRIC DESIGN STANDARDS

#### INTRODUCTION

VDOT has formally adopted the 2011 AASHTO *A Policy on Geometric Design of Highways and Streets*, commonly referred to as the AASHTO “Green Book”, as our minimum design standards. Therefore, **all** design criteria must meet AASHTO minimum standards.

Highway improvement plans are based on established AASHTO geometric design standards for various elements of the roadway under design. The tables on the following pages provide the **minimum** geometric standards, which are to be used for development of VDOT projects except those projects which can be developed using the Guidelines for RRR Projects located in Appendix A, Section A-4 of this manual. Note that there are no specific RRR standards for Interstate projects. If the designer has determined that Guidelines for RRR Projects do not apply to the project in question, the Geometric Design Standard tables on pages A-11 to A-20 should be used for project development.

The Geometric Standard Tables were developed using *A Policy on Geometric Design of Highways and Streets* published by the American Association of State Highway and Transportation Officials (AASHTO). These tables present basic practical guidelines compatible with traffic, topography and safety; however, due to the restrictive format, all variables could not be included. The designer is urged to refer to the above named publication and other related chapters in the *Road Design Manual* for further discussion of design considerations before selecting the proper design speed criteria for a given project.

**THE APPLICATION OF THE CRITERIA PROVIDED IN THE GEOMETRIC DESIGN STANDARD TABLES MUST BE MADE IN RELATION TO THEIR EFFECT ON THE ROADWAY SYSTEM AND IN CONJUNCTION WITH SOUND ENGINEERING JUDGMENT TO ENSURE AN APPROPRIATE DESIGN.** The economic, environmental and social factors involved in highway design shall also be considered. The designer should always attempt to provide for the highest degree of safety and best level of service that is economically feasible. The "minimum" design criteria shown in the tables should only be used when overriding economic or environmental considerations so dictate.

#### FLEXIBILITY IN DESIGN

The policies and procedures addressed in [IIM-LD-235](#) (Context Sensitive Solutions) and [IIM-LD-255](#) (Practical Design Flexibility in the project development process) are intended to clarify and emphasize VDOT's commitment to project and program development processes that provide flexibility, innovative design and Context Sensitive Solutions (CSS) to transportation challenges.

---

\* Rev. 7/16

These processes have been structured and oriented to include stakeholders and citizens in the design of transportation systems that improve public mobility, while reflecting the community's values, preserving the scenic, aesthetic, historic and environmental resources, and without compromising safety and mobility

This policy emphasizes the importance of recognizing the flexibility within established standards, especially AASHTO's *Policy on Geometric Design of Highways and Streets* (Green Book), AASHTO's *A Guide for Achieving Flexibility in Highway Design and AASHTO's Guidelines for Geometric Design of Low-Volume Local Roads (ADT ≤ 400)*. While practicable and innovative approaches to using the flexibility inherent in existing standards is encouraged by this policy, individual project development decisions on specific applications of flexibility ultimately rest with the responsible person working with the project manager and the project team. These decisions are made after carefully processing input from all project stakeholders as well as the project team, and evaluating this input with respect to project goals as well as safety and mobility concerns.

For applicable projects, the following note shall be placed on the title sheet under the Functional Classification and Traffic Data Block: NOTE: THESE PLANS WERE DESIGNED IN ACCORDANCE WITH THE AASHTO GUIDELINES FOR GEOMETRIC DESIGN OF VERY LOW-VOLUME LOCAL ROADS (ADT ≤ 400).

## **SECONDARY PROJECT IMPROVEMENTS**

The Special Session II of the 2008 General Assembly passed HB 6016, which amended and reenacted [§33.2-326](#) of the Code of Virginia relating to improvements to the state secondary highway system components. The intent of this Bill is to ensure that the Department provides flexibility in the use of design criteria for improvements to any secondary highway system component(s) by not requiring the Department to comply with all design and engineering standards that would be applicable if the project involved new construction.

The Department currently utilizes the following flexible design Guidelines:

- **RRR Design Guidelines**, which involves the use of minimal improvements to extend the service life and safety for the existing roadway at a fraction of the cost. On Secondary projects that have a 15 year traffic projection of 750 vpd or less, the RRR guidelines are the design concept of choice.
- **Rural Rustic Road Design Guidelines**, which are used on the secondary highway system that have 1500 vpd or less to pave unpaved secondary roads with no or little geometric improvements.

In addition to the above mentioned practices that follow their own set of guidelines, the Department also encourages roadway designers to identify context sensitive solutions to project issues. It is the responsibility of the roadway design engineer working with the project manager to identify areas where flexibility can be introduced into the design process without compromising safety and mobility.

---

\* Rev. 10/14

The Department has a process for documenting design solutions that do not meet current VDOT and AASHTO design geometric standards in the form of design waivers and design exceptions that shall be submitted in accordance with [IIM-LD-227](#). Any design exception not granted may be appealed to the Chief Engineer.

## ROADWAY WIDTH

Roadway width as referenced in this section is the portion of the highway, including graded shoulders, for vehicular use.

## DESIGN SPEED (V)

Design speed is defined as a speed determined for design and correlation of the physical features of a highway that influence vehicle operation - the maximum safe speed maintainable over a specified section of highway when conditions permit design features to govern.

Except for local streets where speed controls are frequently included intentionally, every effort should be made to use as high a Design Speed as practical to attain a desired degree of safety, mobility, and efficiency within the constraints of environmental quality, economics, aesthetics, and social or political impacts (See 2011 AASHTO Green Book, Chapter 2).\*

The geometric tables indicate a design speed range, or a portion of a range, for each functional classification. The design speed range for each roadway classification is available in the AASHTO Green Book. The selection of the proper design speed to be used on a particular project is of primary importance in project development. The design speed selected should:

- be logical with respect to topography, anticipated operating speed, adjacent land use, and functional classification of the highway.
- be as high as practicable to attain a desired degree of safety, mobility and efficiency while under the constraints of environmental quality, economics, aesthetics and social or political impacts.
- be consistent with the speed a driver is likely to expect. Drivers do not adjust their speeds to the importance of the highway, but to their perception of the physical limitations and traffic.

Although the design speeds for rural highways are coupled with a terrain classification, terrain is only one of the several factors involved in determining the appropriate design speed of a highway.

---

\* Rev. 7/14



Although the selected design speed establishes the maximum degree of curvature and minimum sight distance necessary for safe operation, there should be no restriction on the use of flatter horizontal curves or greater sight distances where such improvements can be provided as a part of economic design. However, if a succession of flatter curves or tangent sections would encourage drivers to operate at higher speeds, that section of highway should be designed for a higher speed and all geometric features, particularly that of sight distance on crest vertical curves and intersection sight distance should be related to it.

The minimum Design Speed shall be based on the following criteria:

1) For roadways with a Posted Speed:

a) For high-speed roadways\* (Posted 50 mph and higher) the Design Speed shall be a minimum of 5 mph higher than the Posted Speed.

- Example - Design Speed 60 mph – Posted Speed 55 mph

b) For low-speed roadways (Posted 45 mph and less) the Design Speed shall be equal to or higher than the Posted Speed.

- Example - Design Speed 40 mph – Posted Speed 40 mph

2) For unposted roadways: Design Speed shall be equal to Statutory Speed or 85% percentile speed (based on speed analysis, rounded up to nearest 5 mph increment).

3) Roadways with ADT < 400, see the VDOT Road Design Manual, Appendix B(1), Tables 1 through 3 and AASHTO's "Guidelines for Geometric Design of Very Low-Volume Local Roads (ADT ≤ 400)".

Posted Speed/Design Speed (All speeds in miles per hour-mph)		
	Posted	Min. Design
Low-Speed Roadways	20	20
	25	25
	30	30
	35	35
	40	40
	45	45
High-Speed Roadways	50	55
	55	60
	60	65
	65	70
	70	75

---

\* Added 7/16

Whenever VDOT criteria (provided above in cases 1-3) are not met, a design waiver is required to document the design speed.

A Design Exception is required if AASHTO minimum design speeds for individual geometric elements are not met.

Additional information is available in NCHRP Report 504 "Design Speed, Operating Speed and Posted Speed Practices", at:

[http://onlinepubs.trb.org/onlinepubs/nchrp/nchrp\\_rpt\\_504.pdf](http://onlinepubs.trb.org/onlinepubs/nchrp/nchrp_rpt_504.pdf) .

For the determination of the roadway posted speed limits, the plans are to indicate the Design Speed (V) of each horizontal and vertical (crest and sag) curve along with the horizontal and vertical curve data.

The Design Speeds (V) are to be determined as follows:\*

#### - Crest Vertical Curves

- See "Sight Distance on Crest Vertical Curves" (VDOT's [Road & Bridge Standards](#), Section 600) to determine sight distance parameters.
- See 2011 AASHTO Green Book "Crest Vertical Curve" criteria, pages 3-151 through 3-157 to determine the Design Controls.

#### - Sag Vertical Curves

- See 2011 AASHTO Green Book "Sag Vertical Curve" criteria, pages 3-157 through 3-161 to determine the Design Controls.

#### Horizontal Curves

- The appropriate Transition Curve Standard (TC-5.01R, TC-5.01U, or TC-5.04ULS, TC-5.11R, TC-5.11U, or TC-5.11ULS) from VDOT'S [Road and Bridge Standards](#), Section 800, provides the Design Speed (V) for horizontal curves (based on the radius of curvature (R) and the superelevation rate (E) provided by GeoPak.

#### SHOWING DESIGN SPEED (V) FOR HORIZONTAL CURVES ON PLANS

The Design Speed shown on the plans for each horizontal curve is not necessarily the Minimum Design Speed shown on the Title Sheet.

GEOPAK supplies the superelevation dependent upon the input (urban/rural, radius, etc.) for each curve but does not provide the design velocity.

Designers shall determine the Design Speed (V) for each curve. This data is to be shown on the plans in the horizontal curve data for each curve.

---

\* Added 7/14

Example:

Title Sheet:

Urban Principal Arterial (TC-5.11U - 2011 AASHTO Green Book)  
45 mph Minimum Design Speed

Horizontal Curve on plans:

Radius = 1533'

Superelevation = 3.3% (provided by GEOPAK)

V = ?

1. To verify the velocity of the horizontal curve compare project radius and superelevation with Design Factors Charts in Section 800 of the Road and Bridge Standards.
2. Start with Page 803.29 TC-5.11U for given Design Speed shown above (45 mph).<sup>\*</sup>
  - ⇒ Chart shows that a curve with 3.3% superelevation and radius of 1446' will support a velocity of 45 mph. The radius on the plans is greater than 1446' (1533').
3. Go to Section 803.30 (50 mph Design Speed).
  - ⇒ Chart shows that a curve with 3.3% superelevation and radius of 1857' will support a velocity of 50 mph, but the radius on the plans is less than 1857' (1533').
4. Therefore, the project radius and superelevation will not support a 50 mph design velocity. The more conservative V = 45 mph shall be shown on the plans as the velocity of the curve.

A Design Exception is required whenever the horizontal curve radius and/or superelevation rate does not support the minimum design speed. See [IIM-LD-227](#) for information on Design Exceptions.

#### ADDITIONAL RESOURCES

Transportation Research Board, *NCHRP Report 504*, Design Speed, Operating Speed, and Posted Speed Practices, available at:  
[http://trb.org/publications/nchrp/nchrp\\_rpt\\_504.pdf](http://trb.org/publications/nchrp/nchrp_rpt_504.pdf)

2004 AASHTO Green Book, "Speed", Chapter 2.

NS 23 CFR 625 available at:

<http://www.fhwa.dot.gov/legsregs/directives/fapg/0625sup.htm>

*The Federal Aide Policy Guide* (FAPG)

---

\* Rev. 7/16

"Compatibility of Design Speed, Operating Speed and Posted Speed" (1995 - By FHWA and TXDOT)

ITE's "Speed: Understanding Design, Operating and Posted Speed" (1997 - By Ray Krammes (FHWA) and Kay Fitzpatrick (TTI))

[Manual on Uniform Traffic Control Devices](#) (MUTCD, 2009 Edition)

- Note that the statutory speed limit is 55 mph for cars and 45 mph for trucks with the following exceptions: 25 mph in residence and business districts; 35 mph in cities and towns; 35 mph on Rural Rustic Roadways; 35 mph on non-surface treated highways. See the Code of Virginia (Speed Limits).

## SHOWING DESIGN SPEED ON TITLE SHEET

See the current version of [Instructional and Informational Memorandum IIM-LD-204](#) for the method of showing design speed data on the plans.

An asterisk is to be shown adjacent to the Design Speed (Example - \* 60 MPH) on the title sheet and the following note shown:

\* See Plan and Profile Sheets for the horizontal and vertical curve design speeds.

## OPERATING SPEED

Operating Speed is the speed at which drivers are observed operating their vehicles during free-flow conditions. The 85<sup>th</sup> percentile of the distribution of observed speeds is the most frequently used measure of the operating speed associated with a particular location or geometric feature of a highway, or highway segment.

## POSTED SPEED

The Posted Speed for existing, new or reconstructed roadways should be determined by factors outlined in the [MUTCD](#), Section 2B.13. The MUTCD requires that an engineering study be conducted in accordance with established engineering practice. VDOT has a standard study template for developing speed limit recommendations which incorporates the MUTCD, Section 2B.13 as well as other considerations pertaining to VDOT's decision-making process for speed limit approvals, including enforcement consensus.

After a project is constructed, the responsible District Traffic Engineer\* will re-establish the speed limit based on established traffic engineering policies. An engineering study will be performed as needed in accordance with documented traffic engineering practices.

---

\* Rev. 1/17

It is important to note that the Design Speed shown on the project title sheet may not be the same as the Design Speed of the individual geometric elements. Each curve on the project (horizontal and vertical) should show a Design Speed for that particular feature. Although these curves may present isolated instances where the physical roadway dictates the speed of vehicles, they shall not be the sole basis for determining the posted speed limit. It is more appropriate to address these locations by warning signs. It is only where the physical roadway features dictate the speed of the vehicles on extended sections, for a major portion of the roadway that they should be considered as a limiting factor in setting the speed limit. Such limitations in speed due to physical features will become apparent in the speed analysis conducted as part of the engineering study.

For design criteria and instructions on signing roadways with a design speed < 25 mph, see the VDOT Road Design Manual, Appendix B(1), Tables 1 through 3 and AASHTO's "Guidelines for Geometric Design of Very Low-Volume Local Roads (ADT  $\leq$  400).

## DESIGN VEHICLE

The type of vehicle that makes frequent turns without encroaching into the adjacent lane when making turns. The tracking of the design vehicle is an important determinant of corner radii at intersections. When the design vehicle traverses an intersection, the design vehicle shall be able to turn from one street to another without deviating from the near travel lane and impeding other traffic flow. Therefore, the design vehicle determines the elements of design such as turning radius and lane width. The design vehicle is to be determined based on the LD-104 Request for Traffic Data and discussed at the Project Scoping Meeting and recorded on the Scoping Worksheet - Roadway Design. \*

The WB-67 shall be the design vehicle used for intersections of freeway ramp terminals with other arterial crossroads and for other intersections on state highways and industrialized streets that carry high volumes of traffic or that provide local access for large trucks.

## DESIGN WAIVERS

Design Waivers are required when deviations from VDOT's design criteria occur. When design criteria meet or exceed AASHTO minimal design but fall short of VDOT's minimal design, a Design Waiver shall be required. Design Waivers will be applicable to all projects regardless of functional classification and funding and shall be documented and approved in accordance with the Design Waiver Request Form [LD-448](#). Please refer to [IIM-LD-227](#) for specific guideline on obtaining design waiver. **This Design Waiver Policy is applicable to VDOT owned and maintained roadways only.**

---

\* Rev. 1/18

## DESIGN EXCEPTIONS

If there are geometric values that are below AASHTO minimum guidelines, the Project Manager/ Design Engineer shall seek to obtain approval of these design exceptions from the State Location and Design Engineer (all projects) and FHWA (if applicable) no later than Public Hearing Stage. Please refer to [IIM-LD-227](#) for specific guideline on obtaining design exceptions.

## FUNCTIONAL CLASSIFICATION

The highway system in Virginia has been functionally classified as Principal Arterial, Minor Arterial, Collector and Local Service. The American Association of State Highway and Transportation Officials (AASHTO) utilizes, as presented in the publication: *A Policy on Geometric Design of Highways and Streets*, referred to as the AASHTO “Green Book”, a similar functional classification system. The designations used are: Freeway, Arterial, Collector, and Local Roads and Streets. Relationships between these two classification systems have been generally developed.

Principal and Minor Arterial Highways provide direct service between cities and larger towns and are high speed, high volume facilities. Collector highways serve small towns directly, connecting them and local roads to the arterial system.

## BACKGROUND

- All roadways are classified as to how the facility functions in accordance with Federal guidelines.
- The Geometric Design Standards in Appendix A of VDOT's *Road Design Manual* are divided by Functional Classification (FC).\*
- The terms "Urban" and "Rural" used in the FC do not necessarily coincide with the terms as applied to highway systems in Virginia.

Urban - Urbanized areas within set boundaries having a population of 5,000 or more. This may include areas outside of incorporated cities and towns.

Rural - Areas not designated as Urban. Includes incorporated cities and towns with populations less than 5,000.

## VIRGINIA HIGHWAY SYSTEMS

Urban - Roadways within the boundaries of incorporated towns and cities with a population of 3,500 or more plus eight other designated urbanized areas (Bridgewater, Chase City, Elkton, Grottoes, Narrows, Pearisburg, Saltville and Woodstock). The urban program is administered by the Local Assistance Division.

Primary - Primary Roadways

Secondary - All secondary roadways except those in Arlington and Henrico Counties. Projects are administered by the Local Assistance Division.

- A project classified as Urban in FC may be part of the Interstate, Arterial, Primary, or Secondary System and will be administered as such. This applies also to projects classified as Rural.
- The Functional Classification block on the title sheet is to show the Geometric Design Standard used.

If more than one standard is used in the design, it will be necessary to set up two Functional Classification blocks since in most cases there would be a change in traffic volumes and scope of work.

---

\* Rev. 7/09

**EXAMPLE**

- When the Functional Classification for a project would normally warrant either Geometric Design Standard GS-1, GS-2, GS-3, or GS-4 and Geometric Design Standard GS-5, GS-6, GS-7 or GS-8, respectively, is used then it will be necessary to show the standard used in the design on the title sheet under the Functional Classification.
- If the normal Geometric standard would be GS-3 and Geometric Standard GS-7 is used, the title sheet is to show:

RURAL COLLECTOR-ROLLING-DIVIDED (Urban St'd. GS-7 was used)

**LANE/SHOULDER/PAVEMENT TRANSITIONS, MERGING TAPERS & SPEED CHANGE LENGTHS**

Lane/shoulder/pavement transitions typically occur where new or reconstructed roadways tie-in to existing roadways. This also applies to where roadways tie-in to bridges. Lane/pavement transitions, merging tapers and speed change lengths shall meet the minimum length provided by the following equations:

For 40 mph or less

$$L = S^2W \div 60$$

For 45 mph or greater

$$L = W \times S$$

L = length of transition

S = Design Speed

W = Width of offset on each side

Source: 2009 MUTCD, Section 6, Table 6C-4

For Temporary Merging, Temporary\* Shifting and Temporary Shoulder Tapers see 2009 MUTCD, Section 6, Table 6C-3 and 6C-4.

For Passing/ Left Turn lanes on Two-Lane Highway See [Appendix "F"](#), [Figure 3-4](#).

**NOTE:**

A pavement transition length of 1/2L (calculate L by using the applicable formula above) is to be used when establishing project termini for the majority of small bridge replacement and/or major bridge rehabilitation projects when "NO" horizontal or vertical geometric changes are required to tie into the existing approach alignment. For additional information see Volume 5, Part 2, of the [Structure and Bridge Manual](#).

Pavement transition is separate from the length of need for guardrail. Length of need and shoulder prep for guardrail shall be in accordance with the VDOT RDM Appendix A and the [Road & Bridge Standards](#).

---

\* Rev. 1/18



### GEOMETRIC DESIGN STANDARDS FOR RURAL PRINCIPAL ARTERIAL SYSTEM (GS-1)

	TERRAIN	DESIGN SPEED (MPH)	MIN. RADIUS	(6) MINIMUM STOPPING SIGHT DISTANCE	MIN. WIDTH OF LANE	(1) MIN. WIDTH OF TOTAL SHOULDERS (GRADED & PAVED)		(2) PAVED SHOULDER WIDTH		(3) MINIMUM WIDTH OF DITCH FRONT SLOPE	(4) SLOPE	NEW AND RECONSTRUCTED MINIMUM BRIDGE WIDTHS AND VERTICAL CLEARANCES
						FILL W/GR	CUT & FILL	LT.	RT.			
INTERSTATES		75	2215'	820'	12'	16'	12'	4' **	10' **	12' @ 6:1	CS-4B	See Footnote (5)
		70	1821'	730'								
		65	1488'	645'								
		60	1204'	570'								
FREEWAYS	LEVEL	75	2215'	820'	12'	16'	12'	4'	10'	12' @ 6:1	CS-4B	
		70	1821'	730'								
	ROLLING	60	1204'	570'							CS-4E	
	MOUNTAINOUS	50	760'	425'								
OTHER PRINCIPAL ARTERIALS	LEVEL	70	1821'	730'	12'	14'	10'	4'	8'	10' @ 6:1	CS-4/ CS-4B	
		60	1204'	570'							CS-4/ CS-4E	
	ROLLING	60	1204'	570'						6' @ 4:1	CS-3/ CS-3B	
		50	760'	425'								
	MOUNTAINOUS	50	760'	425'								
		45	589'	360'								
		40	446'	305'								

#### GENERAL NOTES

Interstates - All new and major reconstructed Interstate facilities will have a posted +5 mph design speed unless concurrence by the State Location and Design Engineer.

Freeways - A design speed of 75 mph should be used for Rural Freeways. Where terrain is mountainous, a design speed of 60 mph or 50 mph which is consistent with driver expectancy, may be used.

Other Principal Arterials - A design speed of 40 to 70 mph should be used depending on terrain, driver expectancy and whether the design is constructed on new location or reconstruction of an existing facility. An important safety consideration in the selection of one of the lower design speeds in each range is to have a properly posted speed limit which should be enforced during off peak hours.

Incorporated towns or other built-up areas, Urban Standard GS-5 may be used for design. "Built-up" is where there is sufficient development along the roadway that justifies a need to channelize traffic into and out of properties utilizing curb and gutter.

Standard TC-5.11R superelevation based on 8% maximum is to be used for all Rural Principal Arterials.

Clear Zone and Recoverable Area information can be found in Appendix A, Section A-2 of the Road Design Manual.

If medians are included, see Section 2E-3 of Chapter 2E of the Road Design Manual.

For additional information on roadway widths and maximum grades relative to terrain and design speed, see AASHTO Green Book, Chapter 7, Section 7.2.2, page 7-4, Tables 7-2 and Section 7.2.3, page 7-5, Table 7-3; for Freeways, see Chapter 8, Section 8.2.7, page 8-4, Table 8-1.

#### FOOTNOTES

- (1) Graded Shoulders include the paved portion. Shoulder widths shown are for right shoulders and independently graded median shoulders. No additional width is necessary for guardrail situations.  
  
For 4-lane non-Interstates (2 lanes in each direction) with independently graded median shoulders, an 8' graded median shoulder will be provided. For 6 or more lanes (Non-Interstate and Interstate), the graded median shoulder shall be the same as right graded shoulder. On Interstates / Freeways, if truck traffic exceeds 250 DDHV, a wider graded shoulder should be considered (14' for fills & cuts and 18' with guardrail).
- (2) When the mainline is 6 or more lanes, the left paved shoulder width should be the same as the right paved shoulder. On Interstates / Freeways, if truck traffic exceeds 250 DDHV, a wider right paved shoulder should be considered (12').  
\*\* AASHTO Minimum, See Interstate Guide.
- (3) A hydraulic analysis is necessary to determine actual depth requirement.
- (4) Additional or modified slope criteria to apply where shown on typical sections.
- (5) See Manual of the Structure and Bridge Division – Volume V – Part 2 Design Aids – Chapter 6 Geometrics.
- (6) For additional information on sight distance requirements on grades of 3 percent or greater, see Section 3.2.2, page 3-5, Tables 3-2 of the AASHTO Green Book.

FIGURE A - 1 - 1\*

\* Rev. 7/18

**GEOMETRIC DESIGN STANDARDS FOR RURAL MINOR ARTERIAL SYSTEM (GS-2)**

TRAFFIC VOLUME	TERRAIN	DESIGN SPEED (MPH)	MIN. RADIUS	(8) MINIMUM STOPPING SIGHT DISTANCE	(2) MIN. WIDTH OF LANE	(3) MIN. WIDTH OF TOTAL SHOULDERS (GRADED & PAVED)		(4) PAVED SHOULDER WIDTH		(5) MINIMUM WIDTH OF DITCH FRONT SLOPE	(6) SLOPE	NEW AND RECONSTRUCTED MINIMUM BRIDGE WIDTHS AND VERTICAL CLEARANCES
						FILL W/GR	CUT & FILL	LT.	RT.			
(1) ADT OVER 2000	LEVEL	70	1821'	730'	12'	14'	10'	4'	8'	10' @ 6:1	CS-4, CS-4A OR CS-4C	See Footnote (7)
		60	1204'	570'								
	ROLLING	60	1204'	570'								
		50	760'	425'								
	MOUNTAINOUS	50	760'	425'								
		45	589'	360'								
40	446'	305'	6' @ 4:1	CS-3/CS-3B								
(1) ADT 1500 TO 2000	LEVEL	70	1821'	730'	12'	12'	8'	4'	6'	6' @ 4:1	CS-4, CS-4A OR CS-4C	
		60	1204'	570'								
	ROLLING	60	1204'	570'								
		50	760'	425'								
	MOUNTAINOUS	50	760'	425'								
		45	589'	360'								11'
40	446'	305'	CS-3/CS-3B									
(1) ADT 400 TO 1500	LEVEL	70	1821'	730'	12'	12'	8'	4'	6'	6' @ 4:1	CS-4, CS-4A OR CS-4C	
		60	1204'	570'								
	ROLLING	60	1204'	570'								
		50	760'	425'								
	MOUNTAINOUS	50	760'	425'								
		45	589'	360'								11'
40	446'	305'	CS-3/CS-3B									
CURRENT ADT UNDER 400	LEVEL	70	1821'	730'	12'	10'	6'	4'	4'	6' @ 4:1	CS-4, CS-4A OR CS-4C	
		60	1204'	570'								
	ROLLING	60	1204'	570'								
		50	760'	425'								
	MOUNTAINOUS	50	760'	425'								
		45	589'	360'								11'
40	446'	305'	CS-3/CS-3B									

**GENERAL NOTES**

Rural Minor Arterials are designed with design speeds of 50 to 70 MPH, dependent on terrain features and traffic volumes, and occasionally may be as low as 40 MPH in mountainous terrain.

In incorporated towns or other built-up areas, Urban Standard GS-6 may be used for design. "Built-up" is where there is sufficient development along the roadway that justifies a need to channelize traffic into and out of properties utilizing curb and gutter.

Standard TC-5.11R superelevation based on 8% maximum is to be used for Rural Minor Arterials.

If medians are included, see Section 2E-3 of Chapter 2E of the *Road Design Manual*.

Clear Zone and Recoverable Area information can be found in Appendix A, Section A-2 of the *Road Design Manual*.

For Passing Sight Distance Criteria, see AASHTO Green Book, Section 3.2.4, page 3-8.

For maximum grades relative to terrain and design speed, see AASHTO Green Book, Chapter 7, Section 7.3.2, page 7-29, Table 7-4.

**FOOTNOTES**

- (1) Use Design Year ADT for new construction and reconstruction projects (not applicable to R.R.R. projects or roads with ADT < 400) in accordance with *Road Design Manual*, Chapter 2A, "REQUEST FOR TRAFFIC DATA" and Form LD-104.

- (2) Lane width to be 12' at all interchange locations. For projects not on the National Highway System, width of traveled way may remain at 22' on reconstructed highways where alignment and safety records are satisfactory.
- (3) When the mainline is 4 lanes (2 lanes in each direction) and a graded median is used, the width of the graded median shoulder is to be 8'.
- (4) When the mainline is 4 lanes (2 lanes in each direction) a minimum 8' wide paved shoulder shall be provided on the right of traffic and a minimum 4' wide paved shoulder on the median side. Where the mainline is 6 or more lanes, both right and median paved shoulders shall be 8' in width. For additional guidance on shoulder widths/reductions, see AASHTO Green Book, Chapter 7, Section 7.2.11, page 7-13.
- (5) A hydraulic analysis is necessary to determine actual depth requirement.
- (6) Additional or modified slope criteria to be applied where shown on typical sections.
- (7) See *Manual of the Structure and Bridge Division – Volume V – Part 2 Design Aids – Chapter 6 Geometrics*.
- (8) For additional information on sight distance requirements on grades of 3 percent or greater, see AASHTO Green Book, Chapter 3, Section 3.2.2, page 3-5, Table 3-2.

**FIGURE A-1-2\***

**GEOMETRIC DESIGN STANDARDS FOR RURAL COLLECTOR ROAD SYSTEM (GS-3)**

TRAFFIC VOLUME	TERRAIN	DESIGN SPEED (MPH)	MIN. RADIUS	(8) MINIMUM STOPPING SIGHT DISTANCE	(2) MIN. WIDTH OF LANE	(3) (4) MINIMUM WIDTH OF GRADED SHOULDERS		(5) MINIMUM WIDTH OF DITCH FRONT SLOPE	(6) SLOPE	NEW AND RECONSTRUCTED MINIMUM BRIDGE WIDTHS AND VERTICAL CLEARANCES
						FILL W/GR	CUT & FILL			
(1) ADT OVER 2000	LEVEL	60	1204'	570'	12'	12'	8'	10' @ 6:1	CS-4, CS-4A OR CS-4C	See Footnote (7)
	ROLLING	50	760'	425'				6' @ 4:1		
	MOUNTAINOUS	45	589'	360'					CS-3 / CS-3B	
		40	446'	305'						
(1) ADT 1500 TO 2000	LEVEL	50	760'	425'	11'	10'	6'	6' @ 4:1	CS-4, CS-4A OR CS-4C	
	ROLLING	45	589'	360'				4' @ 3:1		
		40	446'	305'						
	MOUNTAINOUS	35	316'	250'				CS-3/ CS-3B		
		30	215'	200'						
	(1) ADT 400 TO 1500	LEVEL	50	760'				425'	11'	
ROLLING		45	589'	360'	4' @ 3:1					
		40	446'	305'						
MOUNTAINOUS		35	316'	250'	10'	CS-3/ CS-3B				
		30	215'	200'						
CURRENT ADT UNDER 400	LEVEL	45	589'	360'	10'	8'	2'	6' @ 4:1	CS-1	
		40	446'	305'						
	ROLLING	35	316'	250'				4' @ 3:1		
		30	215'	200'						
	MOUNTAINOUS	25	135'	155'						
		20	77'	125'						

**GENERAL NOTES**

Geometric design features should be consistent with a design speed appropriate for the conditions.

Low design speeds (45 MPH and below) are generally applicable to highways with curvilinear alignment in rolling or mountainous terrain and where environmental conditions dictate.

High speed design (50 MPH and above) are generally applicable to highways in level terrain or where other environmental conditions are favorable.

Intermediate design speeds would be appropriate where terrain and other environmental conditions are a combination of those described for low and high design speed.

The designer should strive for higher values than the minimum where conditions of safety dictate and costs can be supported.

In incorporated towns or other built-up areas, Urban Standard GS-7 may be used. "Built-up" is where there is sufficient development along the roadway that justifies a need to channelize traffic into and out of properties utilizing curb and gutter.

Standard TC-5.11R superelevation based on 8% maximum is to be used for Rural Collectors.

Clear zone and Recoverable Area information can be found in Appendix A, Section A-2 of the *Road Design Manual*.

For Passing Sight Distance Criteria see AASHTO Green Book, Chapter 3, Section 3.2.4, page 3-8.

For maximum grades relative to terrain and design speed, see AASHTO Green Book, Chapter 6, Section 6.2.1, page 6., Table 6-2.

**FOOTNOTES**

- (1) Use Design Year ADT for new construction and reconstruction projects (not applicable to R.R.R. projects or roads with ADT < 400) in accordance with *Road Design Manual*, Chapter 2A, "REQUEST FOR TRAFFIC DATA" and Form LD-104.
- (2) Lane width to be 12' at all interchange locations.
- (3) Provide 4' wide paved shoulders when design year ADT exceeds 2000 VPD, with 5% or more truck and bus usage. Provide 5' wide paved shoulder when design year ADT exceeds 2000 VPD, with 5% or more truck and bus usage and the route is an AASHTO approved U.S. Bicycle Route (1, 76 or 176) or designated as a bicycle route on a locally adopted transportation plan. All shoulders not being paved will have the mainline pavement structure extended 1' on the same slope into the shoulder to eliminate raveling at the pavement edge. For additional guidance on shoulder widths, see AASHTO Green Book, Chapter 6, Section 6.2.2, page 6-6.
- (4) When the mainline is four lanes with ADT >2000, a minimum paved shoulder width of 6' right of traffic and 3' left of traffic will be provided.
- (5) A hydraulic analysis is necessary to determine actual depth requirement.
- (6) Additional or modified slope criteria to be applied where shown on typical sections.
- (7) See *Manual of the Structure and Bridge Division – Volume V – Part 2 Design Aids – Chapter 6 Geometrics*.
- (8) For additional information on sight distance requirements on grades of 3 percent or greater, see AASHTO Green Book, Chapter 3, Section 3.2.2, page 3-2, Table 3-2.
- (9) Shoulder width may be reduced to 4' (8' with guardrail) where appropriate as long as a minimum roadway width of 30' is maintained. See AASHTO Green Book, Chapter 6, Section 6.2.2, page 6-6, Table 6-5.

**FIGURE A - 1 - 3\***

**GEOMETRIC DESIGN STANDARDS FOR RURAL LOCAL ROAD SYSTEM (GS-4)**

TRAFFIC VOLUME	TERRAIN	DESIGN SPEED (MPH)	MIN. RADIUS	(9) MINIMUM STOPPING SIGHT DISTANCE	(2) MINIMUM WIDTH OF SURFACING OR PAVEMENT	(3) (4) (5) MINIMUM WIDTH OF GRADED SHOULDERS		(6) MINIMUM WIDTH OF DITCH FRONT SLOPE	(7) SLOPE	NEW AND RECONSTRUCTED MINIMUM BRIDGE WIDTHS AND VERTICAL CLEARANCES
						FILL W/GR	CUT & FILL			
(1) ADT OVER 2000	LEVEL	50	760'	425'	24'	12'	8'	6' @ 4:1	CS-4, 4A / 4C	See Footnote (8)
	ROLLING	45	589'	360'						
		40	446'	305'						
	MOUNTAINOUS	35	316'	250'						
30		215'	200'							
(1) ADT 1500 TO 2000	LEVEL	50	760'	425'	22'	10'	6'	6' @ 4:1	CS-4, 4A / 4C	
	ROLLING	45	589'	360'						
		40	446'	305'						
	MOUNTAINOUS	35	316'	250'						
30		215'	200'							
(1) ADT 400 TO 1500	LEVEL	50	760'	425'	22'	9'	5'	6' @ 4:1	CS-1	
	ROLLING	45	589'	360'						
		MOUNTAINOUS	40	446'	305'					
	30		215'	200'						
CURRENT ADT UNDER 400	LEVEL	45	589'	360'	18'	8'	2'	4' @ 3:1	CS-1	
		40	446'	305'						
	ROLLING	35	316'	250'						
		30	215'	200'						
	MOUNTAINOUS	25	135'	155'						
		20	77'	125'						

**GENERAL NOTES**

Low design speeds are generally applicable to roads with winding alignment in rolling or mountainous terrain where environmental conditions dictate.

High design speeds are generally applicable to roads in level terrain or where other environmental conditions are favorable.

Intermediate design speeds would be appropriate where terrain and other environmental conditions are a combination of those described for low and high speed.

For minimum design speeds for 250 ADT and under, see AASHTO Green Book, Chapter 5, Section 5.2.1, page 5-2, Table 5-1.

Standard TC-5.11R superelevation based on 8% maximum is to be used.

In incorporated towns or other built-up areas, Urban Standard GS-8 may be used. "Built-up" is where there is sufficient development along the roadway that justifies a need to channelize traffic into and out of properties utilizing curb and gutter.

For Passing Sight Distance Criteria See AASHTO Green Book, Chapter 3, Section 3.2.4, page 3-8.

For maximum grades relative to terrain and design speed, see AASHTO Green Book, Chapter 5, Section 5.2.1, page 5-3, Table 5-2.

For Recreational Access Road design standards, see AASHTO Green Book, Chapter 5, Section 5.4.2, page 5-24.

- (2) Lane width to be 12' at all interchange locations.
- (3) In mountainous terrain or sections with heavy earthwork, the graded width of shoulder in cuts may be decreased by 2', but in no case shall the cut shoulder width be less than 2'.
- (4) Minimum shoulder slope shall be 8% on low side and same slope as pavement on high side (See St'd. GS-12).
- (5) Provide 4' wide paved shoulders when design year ADT exceeds 2000 VPD, with 5% or more truck and bus usage. Provide 5' wide paved shoulder when design year ADT exceeds 2000 VPD, with 5% or more truck and bus usage and the route is an AASHTO approved U.S. Bicycle Route (1, 76 or 176) or designated as a bicycle route on a locally adopted transportation plan All shoulders not being paved will have the mainline pavement structure extended 1' on the same slope into the shoulder to eliminate raveling at the pavement edge. For additional guidance on shoulder widths, see AASHTO Green Book, Chapter 5, Section 5.2.2, page 5-6.
- (6) A hydraulic analysis is necessary to determine actual depth requirement.
- (7) Additional or modified slope criteria to be applied where shown on typical sections.
- (8) See [Manual of the Structure and Bridge Division – Volume V – Part 2 Design Aids – Chapter 6 Geometrics](#).
- (9) For additional information on sight distance requirements on grades of 3 percent or greater, see AASHTO Green Book, Chapter 3, Section 3.2.2, page 3-2, Table 3-2.

**FOOTNOTES**

- (1) Use Design Year ADT for new construction and reconstruction projects in accordance with [Road Design Manual](#), Chapter 2A, "REQUEST FOR TRAFFIC DATA" and Form LD-104. For RRR projects or roads with ADT < 400, See Road Design Manual, Appendix A, "GUIDELINES FOR RRR PROJECTS."

**FIGURE A - 1 - 4\***

**GEOMETRIC DESIGN STANDARDS FOR URBAN PRINCIPAL ARTERIAL SYSTEM (GS-5)**

	DESIGN SPEED (MPH)	MINIMUM RADIUS		(13) MINIMUM STOPPING SIGHT DISTANCE	MIN. WIDTH OF LANE	(1) MIN. WIDTH OF TOTAL SHOULDERS (GRADED & PAVED)		(2) PAVED SHOULDER WIDTH		(3) MINIMUM WIDTH OF DITCH FRONT SLOPE	(4) SLOPE	NEW AND RECONSTRUCTED MINIMUM BRIDGE WIDTHS AND VERTICAL CLEARANCES
		U	ULS			FILL W/GR	FILL & CUT	LT.	RT.			
INTERSTATES	70	USE TC-5.11R SEE GS-1	-	730'	12'	16'	12'	4 <sup>***</sup> MIN.	10 <sup>**</sup> MIN.	12' @ 6:1	CS-4 OR 4B	See Footnote (7)
	65		-	645'								
	60		-	570'								
FREEWAYS	70		-	730'	12'	16'	12'	4'	10'	12' @ 6:1	CS-4 OR 4B	
	60		-	570'								
	50		-	425'							CS-4 OR 4E	
OTHER PRINCIPAL ARTERIAL WITH SHOULDER DESIGN	60	-	570'	(12)	14'	10'	4'	8'	10' @ 6:1	CS-4 OR 4E		
	50	929'	-	425'					12'			
	45	713'	795'	360'					(5) (6) (12) 11'	6' @ 4:1	CS-3 OR 3B	
	40	536'	593'	305'								
	35	373'	408'	250'								
30	251'	273'	200'									
	DESIGN SPEED (MPH)	MINIMUM RADIUS		(13) MINIMUM STOPPING SIGHT DISTANCE	MIN. WIDTH OF LANE	(8) STANDARD CURB & CURB & GUTTER	BUFFER STRIP WIDTH	(9) MINIMUM SIDEWALK WIDTH	(10) SLOPE			
OTHER PRINCIPAL ARTERIAL WITH CURB & GUTTER	60	GS-1	-	570'	(12)	CG-3 / CG-7	(11)	5' @ 3 1/2:1	2:1			
	50	929'	-	425'	12'							
	45	713'	795'	360'	(5) (6) (12) 11'	(14) CG-2 / CG-6						
	40	536'	593'	305'								
	35	373'	408'	250'								
	30	251'	273'	200'								

**GENERAL NOTES\***

Freeways - Urban Freeways should accommodate desired safe operating speeds during non-peak hours, but should not be so high as to exceed the limits of prudent construction, right of way and socioeconomic costs due to the large proportion of vehicles which are accommodated during periods of peak flow when lower speeds are necessary. The design speeds for Freeways shall not be less than 50 mph.

On many Urban Freeways, particularly in suburban areas, a design speed of 60 mph or higher can be provided with little additional cost above that required for 50 mph design speed. The corridor of the mainline may be relatively straight and the character and location of interchanges may permit high speed design. Under these conditions, a design speed of 70 mph is most desirable because the higher design speeds are closely related to the overall quality and safety of the facility.

Other Principal Arterials - Design speeds for Urban Arterials generally range from 40 to 60 mph, and occasionally may be as low as 30 mph. The lower (40 mph and below) speeds apply in the central business district and intermediate areas. The higher speeds are more applicable to the outlying business and developing areas.

Standard TC-5.11R (Rural) superelevation based on 8% maximum is to be used for ALL Interstates, Freeways (50 – 70 mph) and for Other Principal Arterials with a design speed of 60 mph. For minimum radius, See GS-1.

Standard TC-5.11U (Urban) superelevation based on 4% maximum is to be used on Other Principal Arterials with a design speed of 50 mph and less.

Standard TC-5.11ULS (Urban Low Speed) superelevation based on 2% maximum is may be used on Other Principal Arterials with a design speed less than or equal to 45 mph.

Clear Zone and Recoverable Area information can be found in Appendix A, Section A-2 of the *Road Design Manual*.

If medians are included, see Section 2E-3 of Chapter 2E of the *Road Design Manual*. For minimum widths for roadway & right of way used within incorporated cities or towns to qualify for maintenance funds see Code of Va. Section 33.2-319.

For maximum grades relative to terrain and design speed, see AASHTO Green Book, Chapter 7, Section 7.3.3, page 7-29, Table 7-4, for Freeways, see Chapter 8, Section 8.2.7, page 8-4, Table 8-1.

**FOOTNOTES**

- (1) Shoulder widths shown are for right shoulders and independently graded median shoulders. An 8' graded median shoulder will be provided when the mainline is 4 lanes (2 lanes in each direction). For 6 or more lanes (Non-Interstate and Interstate), the median shoulder provided will be the same as that shown for independent grading. On Interstates / Freeways, if truck traffic exceeds 250 DDHV, a wider graded shoulder should be considered (14' for fills & cuts and 18' with guardrail).
- (2) When the mainline is 6 or more lanes, the left paved shoulder width should be the same as the right paved shoulder. On Interstates / Freeways, if truck traffic exceeds 250 DDHV, a wider right paved shoulder should be considered (12').  
\*\* AASHTO Minimum, See Interstate Guide.
- (3) A hydraulic analysis is necessary to determine actual depth requirement.
- (4) Additional or modified slope criteria apply where shown on typical sections.
- (5) Minimum lane widths to be 12' at all interchange locations.
- (6) Where heavy truck volume (equal to or greater than 10%) or bus traffic is anticipated, an additional 1 foot width should be considered.
- (7) See [Manual of the Structure and Bridge Division – Volume V – Part 2 Design Aids – Chapter 6 Geometrics](#).
- (8) Or equivalent City or Town design.
- (9) Width of 8' or more may be needed in commercial areas.
- (10) 3:1 and flatter slopes shall be used when the right of way is behind the sidewalk (or sidewalk space) in residential or other areas where slopes will be maintained by the property owner.
- (11) For buffer strip widths see Appendix A(1), Section A(1)-1 Bicycle & Pedestrian Facility Guidelines.
- (12) Situations having restrictions on trucks may allow the use of lanes 1 foot less in width.
- (13) For additional information on sight distance requirements on grades of 3 percent or greater, see AASHTO Green Book, Section 3.2.2, page 3-2, Table 3-2. For Intersection sight distance requirements see [Append. F, Table 2-5](#).
- (14) Where bicycle accommodation is next to curb or curb and gutter, mountable curb (CG-3) or mountable curb and gutter (CG-7) shall be used for design speeds of 45 mph and below.

**FIGURE A - 1 - 5**

### GEOMETRIC DESIGN STANDARDS FOR URBAN MINOR ARTERIAL STREET SYSTEM (GS-6)

	DESIGN SPEED (MPH)	MINIMUM RADIUS		(12) MINIMUM STOPPING SIGHT DISTANCE	(11) MIN. WIDTH OF LANE	(3) STANDARD CURB & GUTTER	BUFFER STRIP WIDTH	(4) MINIMUM SIDEWALK WIDTH	(5) SLOPE	NEW AND RECONSTRUCTED MINIMUM BRIDGE WIDTHS AND VERTICAL CLEARANCES		
		U	ULS									
STREETS WITH CURB & GUTTER	60	1204'	-	570'	12'	CG-3 / CG-7	(10)	5'	2:1	See Footnote (6)		
	50	929'	-	425'								
	45	713'	795'	360'	(1) (2) 11'	(14) CG-2 / CG-6						
	40	536'	593'	305'								
	35	373'	408'	250'								
	30	251'	273'	200'								
	DESIGN SPEED (MPH)	MINIMUM RADIUS		(12) MINIMUM STOPPING SIGHT DISTANCE	(11) MIN. WIDTH OF LANE	(7) (13) MINIMUM WIDTH GRADED SHOULDER		(8) MINIMUM PAVED SHOULDER WIDTH			(9) MINIMUM WIDTH OF DITCH FRONT SLOPE	(5) SLOPE
		U	ULS			FILL W/GR	CUT & FILL	LT.	RT.			
(13) STREETS WITH SHOULDER DESIGN	60	1204'	-	570'	12'	14'	10'	4'	8'		10' @ 6:1	2:1
	50	929'	-	425'								
	45	713'	795'	360'	(1) (2) 11'						6' @ 4:1	
	40	536'	593'	305'								
	35	373'	408'	250'								
	30	251'	273'	200'								

#### GENERAL NOTES\*

Design Speeds for Urban Arterials generally range from 40 to 60 mph and occasionally may be as low as 30 mph. The lower (40 mph and below) speeds apply in the central business district and intermediate areas. The higher speeds are more applicable to the outlying business and developing areas.

Standard TC-5.11R (Rural) superelevation based on 8% maximum is to be used for 60 mph design speed.

Standard TC-5.11U (Urban) superelevation based on 4% maximum is to be used for design speeds less than 60 mph.

Standard TC-5.11ULS (Urban Low Speed) superelevation based on 2% maximum may be used for design speeds less than or equal to 45 mph.

Clear Zone and Recoverable Area information can be found in Appendix A, Section A-2 of the *Road Design Manual*.

If medians are included, see [Section 2E-3 of Chapter 2E](#) of the *Road Design Manual*.

For minimum widths for roadway and right of way used within incorporated cities or towns to qualify for maintenance funds see [Code of Virginia Section 33.2-319](#).

For maximum grades relative to terrain and design speed, see AASHTO Green Book, Chapter 7, Section 7.3.2, page 7-29, Table 7-4.

#### FOOTNOTES

- (1) Lane width to be 12' at all interchanges.
- (2) Where heavy truck volume (equal to or greater than 10%) or bus traffic is anticipated, an additional 1 foot width should be considered.
- (3) Or equivalent City or Town design.
- (4) A width of 8' or more may be needed in commercial areas.
- (5) Slopes 3:1 and flatter shall be used when the right of way is behind the sidewalk (or sidewalk space) in residential or other areas where slopes will be maintained by the property owner.
- (6) See [Manual of the Structure and Bridge Division – Volume V – Part 2 Design Aids – Chapter 6 Geometrics](#).
- (7) If graded median is used, the width of median shoulder is to be 8' (See Standard GS-11 for shoulder design).
- (8) When the mainline is 4 lanes (2 lanes in each direction) a minimum 8' wide paved shoulder will be provided on the right of traffic and a minimum 4' wide paved shoulder on the median side. Where the mainline is 6 or more lanes, both right and median paved shoulders will be 8' in width. For additional guidance on shoulder widths/reductions, see AASHTO Green Book, Chapter 7, Section 7.2.11, page 7-13.
- (9) A hydraulic analysis is necessary to determine actual depth requirement.
- (10) For buffer strip widths see Appendix A(1), Section A(1)-1 Bicycle & Pedestrian Facility Guidelines.
- (11) Situations having restrictions on trucks may allow the use of lanes 1 foot less in width.
- (12) For additional information on sight distance requirements on grades of 3 percent or greater, see AASHTO Green Book, Chapter 3, Section 3.2.2, page 3-2, Table 3-2.
- (13) For information on reduced shoulder widths, see AASHTO Green Book, Chapter 7, Section 7.2.3, page 7-5, Table 7-3.
- (14) Where bicycle accommodation is next to curb or curb and gutter, mountable curb (CG-3) or mountable curb and gutter (CG-7) shall be used for design speeds of 45 mph and below.

FIGURE A - 1 - 6



## GEOMETRIC DESIGN STANDARDS FOR URBAN COLLECTOR STREET SYSTEM (GS-7)

	DESIGN SPEED (MPH)	MINIMUM RADIUS		(10) MINIMUM STOPPING SIGHT DISTANCE	(13) MINIMUM WIDTH OF LANE	(3) STANDARD CURB & GUTTER	BUFFER STRIP WIDTH	(4) MINIMUM SIDEWALK WIDTH	(5) SLOPE	NEW AND RECONSTRUCTED MINIMUM BRIDGE WIDTHS AND VERTICAL CLEARANCES
		U	ULS							
STREET WITH CURB & GUTTER	50	929'	-	425'	12'	CG-3 / CG-7	(9)	5'	2:1	
	45	713'	795'	360'	(1) (2) (12) 11'	(14) CG-2 / CG-6				
	40	536'	593'	305'						
	35	373'	408'	250'						
	30	251'	273'	200'						
	DESIGN SPEED (MPH)	MINIMUM RADIUS		(10) MINIMUM STOPPING SIGHT DISTANCE	(13) MINIMUM WIDTH OF LANE	(7) (11) MINIMUM WIDTH OF GRADED SHOULDERS		(6) MINIMUM WIDTH OF DITCH FRONT SLOPE	(5) SLOPE	See Footnote (8)
	U	ULS	FILL W/GR			CUT & FILL				
(11) STREET WITH SHOULDER DESIGN	50	929'	-	425'	12'	12'	8'	6' @ 4:1	2:1	
	45	713'	795'	360'	(1) (2) (12) 11'					
	40	536'	593'	305'						
	35	373'	408'	250'						
	30	251'	273'	200'						
							4' @ 3:1			

### GENERAL NOTES

A minimum design speed of 30 mph or higher should be used for collector streets, depending on available right of way, terrain, adjacent development and other area controls.

In the typical street grid, the closely spaced intersections usually limit vehicular speeds and thus make the effect of design speed of less significance. Nevertheless, the longer sight distances and curve radii commensurate with design speeds higher than the value indicated result in safer highways and should be used to the extent practicable.

Standard TC-5.11U (Urban) superelevation based on 4% maximum.

Standard TC-5.11ULS (Urban-Low Speed) superelevation based on 2% maximum may be used with a design speed of 45 mph or less.

For minimum widths for roadway and right of way used within incorporated cities or towns to qualify for maintenance funds see [Code of Virginia Section 33.2-319](#).

Clear zone and Recoverable Area information can be found in Appendix A, Section A-2 of the [Road Design Manual](#).

For maximum grades relative to terrain and design speed, see AASHTO Green Book, Chapter 6, Section 6.3.1, page 6-12, Table 6-8.

### FOOTNOTES

- (1) Lane width should be 12' in industrial areas. Where Right of Way is restricted 11' lanes may be used in industrial areas. (See AASHTO Green Book Chapter 6, Section 6.2.2 and 6.3.2, page 6-5, Table 6-5).
- (2) Lane width to be 12' at all interchange locations.
- (3) Or equivalent City or Town Design.
- (4) 8' or more may be needed in commercial areas.

- (5) 3:1 and flatter slopes shall be used when right of way is behind the sidewalk (or sidewalk space) in residential or other areas where the slopes will be maintained by the property owner.
- (6) A hydraulic analysis is necessary to determine actual depth requirement.
- (7) When Design year ADT exceeds 2000 VPD, with greater than 10% total truck and bus usage: Provide 4' wide paved shoulders when the graded shoulder is 5' wide or greater. Provide 5' wide paved shoulder when design year ADT exceeds 2000 VPD, with 5% or more truck and bus usage and the route is an AASHTO approved U.S. Bicycle Route (1, 76 or 176) or designated as a bicycle route on a locally adopted transportation plan. All shoulders not being paved will have the mainline pavement structure extended 1', on the same slope, into the shoulder to eliminate raveling at the pavement edge. (See Standard GS-11 for shoulder design).
- (8) See [Manual of the Structure and Bridge Division – Volume V – Part 2 Design Aids – Chapter 6 Geometrics](#).
- (9) For buffer strip widths see Appendix A(1), Section A(1)-1 Bicycle & Pedestrian Facility Guidelines.
- (10) For additional information on sight distance requirements on grades of 3 percent or greater, see AASHTO, Green Book, Chapter 3, Section 3.2.2, page 3-3, Table 3-2.
- (11) Where shoulders are provided, roadway widths in accordance with Table 6-5, page 6-6 should be considered. (See AASHTO Green Book, Chapter 6, Section 6.3.2, page 6-13.)
- (12) Where heavy truck volume (equal to or greater than 10%) or bus traffic is anticipated, an additional 1 foot width should be considered.
- (13) Situations having restrictions on trucks may allow the use of lanes 1 foot less in width.
- (14) Where bicycle accommodation is next to curb or curb and gutter, mountable curb (CG-3) or mountable curb and gutter (CG-7) shall be used for design speeds of 45 mph and below.

**FIGURE A - 1 - 7\***

**GEOMETRIC DESIGN STANDARDS FOR URBAN LOCAL STREET SYSTEM (GS-8)**

	DESIGN SPEED (MPH)	MINIMUM RADIUS		(1) MAXIMUM PERCENT OF GRADE	(10) MINIMUM STOPPING SIGHT DISTANCE	(2) MINIMUM WIDTH OF LANE	(3) STANDARD CURB & CURB & GUTTER	BUFFER STRIP WIDTH	(5) MINIMUM SIDEWALK WIDTH	(6) SLOPE	NEW AND RECONSTRUCTED MINIMUM BRIDGE WIDTHS AND VERTICAL CLEARANCES
		U	ULS								
STREET WITH CURB & GUTTER	30	251'	273'	15	200'	10'	CG-2 / CG-6	(4)	5'	2:1	See Footnote (9)
	25	155'	167'		155'						
	20	87'	92'		125'						
	DESIGN SPEED (MPH)	MINIMUM RADIUS		(1) MAXIMUM PERCENT OF GRADE	(10) MINIMUM STOPPING SIGHT DISTANCE	(2) MINIMUM WIDTH OF LANE	(7) (11) MINIMUM WIDTH OF GRADED SHOULDERS		(8) MINIMUM WIDTH OF DITCH FRONT SLOPE	SLOPE	
		U	ULS				FILL W/GR	CUT& FILL			
(11) STREET WITH SHOULDER DESIGN	30	251'	273'	15	200'	10'	12'	8'	4' @ 3:1	3:1	
	25	155'	167'		155'						
	20	87'	92'		125'						

**GENERAL NOTES**

Design Speed is not a major factor for local streets. For consistency in design elements, design speeds ranging from 20 to 30 mph may be used, depending on available right of way, terrain, adjacent development and other area controls.

In the typical street grid, the closely spaced intersections usually limit vehicular speeds, making the effect of a design speed of less significance.

Design speeds exceeding 30 mph in residential areas may require longer sight distances and increased curve radii, which would be contrary to the basic function of a local street.

Standard TC-5.11U (Urban) superelevation based on 4% maximum.

Standard TC-5.11ULS (Urban Low Speed) superelevation based on 2% maximum may be used with a design speed of 45 mph or less.

For minimum widths for roadway and right of way used within incorporated cities or towns to qualify for maintenance funds see [Code of Virginia Section 33.2-319](#).

**FOOTNOTES**

- (1) Grades in commercial and industrial areas should be less than 8 percent; desirably, less than 5 percent. For maximum grades relative to terrain and design speed, see AASHTO Green Book, Chapter 5, Section 5.2.1, page 5-3, Table 5-2.
- (2) Where feasible, lanes should be 11' wide and in industrial areas should be 12' wide; however, where available or attainable right of way imposes severe limitations, 9' lanes can be used in residential areas and 11' lanes can be used in industrial areas.

- (3) Or equivalent City or Town design.
- (4) For buffer strip widths see Appendix A(1), Section A(1)-1 Bicycle & Pedestrian Facility Guidelines.
- (5) A width of 8' or more may be needed in commercial areas.
- (6) 3:1 and flatter slopes shall be used when the right of way is behind the sidewalk (or sidewalk space) in residential or other areas where slopes will be maintained by the property owner.
- (7) When Design year ADT exceeds 2000 VPD, with greater than 5% total truck and bus usage: Provide 4' wide paved shoulders when the graded shoulder is 5' wide or greater. Provide 5' wide paved shoulder when design year ADT exceeds 2000 VPD, with 5% or more truck and bus usage and the route is an AASHTO approved U.S. Bicycle Route (1, 76 or 176) or designated as a bicycle route on a locally adopted transportation plan. All shoulders not being paved will have the mainline pavement structure extended 1', on the same slope, into the shoulder to eliminate raveling at the pavement edge (See Standard GS-12 for shoulder design).
- (8) A hydraulic analysis is necessary to determine actual depth requirement.
- (9) See [Manual of the Structure and Bridge Division – Volume V – Part 2 Design Aids – Chapter 6 Geometrics](#).
- (10) For additional information on sight distance requirements on grades of 3 percent or greater, see AASHTO Green Book, Chapter 3, Section 3.2.2, page 3-2, Table 3-2.
- (11) For information on reduced shoulder widths, see AASHTO Green Book, Chapter 5, Section 5.2.2, page 5-6, Table 5-5.

**FIGURE A - 1 - 8\***



**GEOMETRIC DESIGN STANDARDS FOR SERVICE ROADS (GS-9)**

(1) DEAD END SERVICE ROADS UNDER 25 VPD								
PROPERTIES SERVED	DESIGN SPEED (MPH)	MINIMUM RADIUS	STOPPING SIGHT DISTANCE	(2) MINIMUM TRAVEL WAY WIDTH	MINIMUM WIDTH OF SHOULDER		(3) MINIMUM WIDTH OF DITCH FRONT SLOPE	SLOPE
					FILL W/GR	CUT & FILL		
1	10	30'	50'	12'	6'	2'	3' @ 3:1	(4)
	15	38'	80'					
OVER 1	20	77'	125'	16'				
	25	135'	155'					
	30	215'	200'	18'				
	35	316'	250'					
40	446'	305'						

**GENERAL NOTES**

The minimum design speed for service roads should be 20 mph except for one lane service roads serving one property which may have a minimum design speed of 10 mph.

Standard TC-5.11R superelevation is based on 8% maximum.

For Passing Sight Distance Criteria See AASHTO Green Book, Chapter 3, Section 3.2.4, page 3-8.

**FOOTNOTES**

- (1) For through service roads and dead end service roads with over 25 VPD, use Standards shown for Local Roads and Streets (Also See Standard GS-12).
- (2) Under adverse conditions, intermittent shoulder sections or turnouts for passing may be required (see AASHTO Green Book, Chapter 5, Section 5.4.2, page 5-29).
- (3) A hydraulic analysis is necessary to determine actual depth requirement.
- (4) Slopes to be same as mainline when service road is parallel to or otherwise visible from the mainline. For other cases, slopes should be in accordance with standards for Local Roads and Streets.

RELATIONSHIP OF MAXIMUM GRADES TO DESIGN SPEED				
TYPE OF TERRAIN	DESIGN SPEED (MPH)			
	10	20	30	40
	GRADES (PERCENT)			
LEVEL	8	8	7	7
ROLLING	12	11	10	9
MOUNTAINOUS	18	16	14	12

**FIGURE A - 1 - 9\***

\* Rev. 1/18

**GEOMETRIC DESIGN STANDARDS FOR INTERCHANGE RAMPS (GS-R)**

	RAMP DESIGN SPEED (MPH)	MINIMUM RADIUS	(6) MINIMUM STOPPING SIGHT DISTANCE	(1) MINIMUM RAMP PAVEMENT WIDTHS	MINIMUM WIDTH OF SHOULDER				(5) MINIMUM WIDTH OF DITCH FRONT SLOPE	NEW AND RECONSTRUCTED MINIMUM BRIDGE WIDTHS AND VERTICAL CLEARANCES	
					LEFT OF TRAFFIC		RIGHT OF TRAFFIC				
					GRADED WIDTH		(2) (3) PAVED WIDTH	(7) GRADED WIDTH			(2) (3) PAVED WIDTH
					FILL W/GR	CUT & FILL					
INTERCHANGE RAMPS	60	1204'	570'	16'	10'	6'	4'	10'	8'	10' @ 6:1	See Footnote (4)
	50	760'	425'								
	45	589'	360'								
	40	446'	305'								
	35	316'	250'								
	30	215'	200'								
	25	135'	155'								
20	77'	125'	18'								
AUXILIARY LANES (ACCEL/ DECEL)	(8) GEOMETRIC DESIGN ELEMENTS ARE TO BE THE SAME AS MAINLINE THROUGH LANES. SEE APPLICABLE FUNCTIONAL CLASSIFICATION GS STANDARDS.									AUXILIARY LANE SHOULDER WIDTHS ARE TO BE THE SAME AS MAINLINE THROUGH LANES	

**GENERAL NOTES**

**FOOTNOTES**

The determination of the proper design speed for any particular ramp should be made using guidelines shown in the AASHTO Green Book, Chapter 10, Section 10.9.6, page 10-89, Table 10-1.

Standard TC-5.11R is to be used. Maximum ramp superelevation is to be 8%.

Clear Zone and Recoverable Area information can be found in Appendix A, Section A-2 of the *Road Design Manual*.

RELATIONSHIP OF MAXIMUM GRADES TO DESIGN SPEED			
DESIGN SPEED (MPH)			
15 - 20	25 - 30	35 - 40	45 - 60
GRADES (PERCENT)			
6 - 8	5 - 7	4 - 6	3 - 5

Where topographic conditions dictate, grades steeper than those above may be used. One-way descending gradients on ramps should be held to the same general maximums, but in special cases they may be 2 percent greater. However, downgrades with sharp horizontal curvature and significant heavy truck or bus traffic should be limited to 4 percent. See page 10-92 of the AASHTO Green Book.

See the AASHTO Green Book Chapter 10, Section 10.9.6, page 10-87 for further guidance on ramp design.

- (1) Interchange ramp widths shown are for one lane traffic. For two lane or other conditions see Table 3-29 in the AASHTO Green Book.
- (2) Paved shoulder widths on ramps with a design speed of 40 mph or less may be reduced to 6' right, or 3' left, when justifiable. However, the sum of the right and left shoulder shall not be less than 10'. See AASHTO Green Book, Chapter 10, Section 10.9.6, page 10-102.
- (3) On ramps with a radius of less than 500', consider (depending on degree of curvature, percent of trucks) the extension of the full pavement structure (on the same slope as the pavement) through the inside paved shoulder area to eliminate raveling of the pavement edge.
- (4) See [Manual of the Structure and Bridge Division – Volume V – Part 2 Design Aids – Chapter 6 Geometrics](#).
- (5) A hydraulic analysis is necessary to determine actual depth requirement.
- (6) For additional information on sight distance requirements on grades of 3 percent or greater, see the AASHTO Green Book, Chapter 3, Section 3.2.2, page 3-2, Table 3-2.
- (7) Graded shoulder width to be increased additional 4' when guardrail is required.
- (8) See 2011 AASHTO Green Book, Chapter 10, Section 10.9.5, page 10-76 for further guidance on Auxiliary Lanes.

**FIGURE A - 1 - 10\***

\* Rev. 1/18

## GEOMETRIC DESIGN STANDARDS FOR TEMPORARY DIVERSION (GS-10)

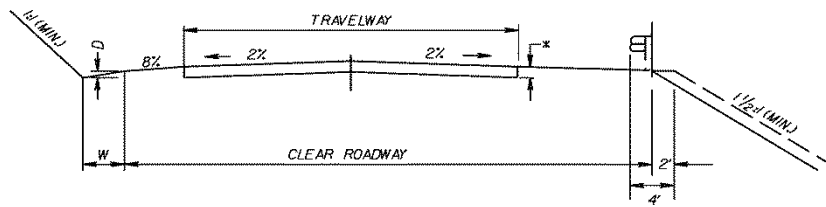

**TYPICAL SECTION**

BRIDGE WIDTH = APPROACH ROADWAY WIDTH (CLEAR ROADWAY).

\* SEE PLANS FOR BASE DEPTH AND TYPE AND PAVED SURFACE TREATMENT WHERE REQUIRED.

NOTE: WHEN GUARDRAIL IS REQUIRED IT SHALL BE INSTALLED IN ACCORDANCE WITH THE ROAD & BRIDGE STANDARDS

WIDTHS FOR TWO WAY TRAFFIC (LESSER WIDTH MAY BE USED FOR ONE-WAY)								
TYPE	CURRENT ADT	* TRAVELWAY WIDTH	SURFACE		MIN. ROADWAY SHOULDER TO SHOULDER	DITCH WIDTH (W) (FEET)	DITCH DEPTH (D) (INCHES)	PAY ITEM
			UNPAVED	PAVED				
A	0-250	18'	✓		22'	4'	16"	LF.
B	251- 750	20'	✓		24' ABS. 30' DES.	4'	16"	LF.
C	751- 2000	22'		✓	30' ABS. 34' DES.	4'	16"	* *
D	2001- 5500	24'		✓	40'	4'	16"	* *
E	5501- 15,000	24'		✓	40'	4'	16"	* *
F	15,000- ABOVE	24'		✓	40'	6'	18"	* *

NOTE: WIDTH FOR 2 WAY TRAFFIC SHALL NOT BE LESS THAN THE PROPOSED TYPICAL.

\* CURVES TO BE WIDENED IN ACCORDANCE WITH ST'D.TC-5.01R.

\*\* PAID FOR BY INDIVIDUAL QUANTITIES.

GEOMETRICS							
DESIGN SPEED M.P.H.		20	30	40	50	60	70
MIN. RADII		108' R	251' R	465' R	760' R	1204' R	1821' R
MAX. % GRADE	DES.	8%	7%	7%	6%	5%	5%
	ABS.	16%	14%	13%	10%	6%	6%
STOPPING SIGHT DISTANCE	DES.	125'	200'	325'	475'	650'	850'
	MIN.			305'	425'	570'	730'
MAXIMUM SUPERELEVATION		8%	8%	8%	8%	8%	8%

IF GEOMETRICS AND WIDTHS SHOWN IN THESE CHARTS ARE GREATER THAN THE FINISHED CONTRACT DESIGN, APPROVAL MAY BE GRANTED BY THE DEPARTMENT FOR LESSER VALUES.

### MINIMUM DESIGN CRITERIA FOR TEMPORARY DETOURS (MAINTENANCE OF TRAFFIC)

**FIGURE A - 1 - 11\***

**GEOMETRIC DESIGN STANDARDS FOR SHOULDER DESIGN (GS-11)**

*GRADED MEDIAN SHOULDERS*

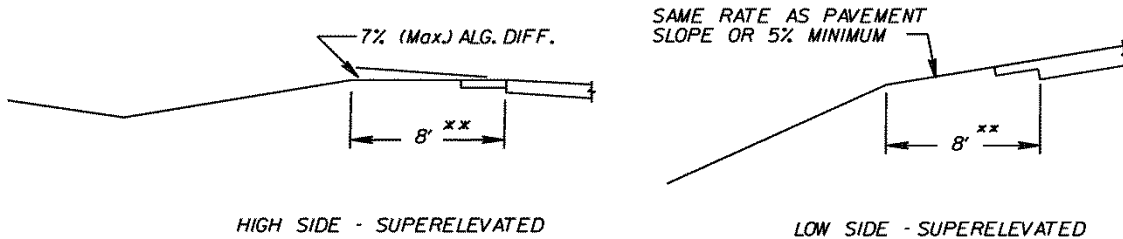

\*\* WHERE MAINLINE IS 6 OR MORE LANES GRADED SHOULDER WIDTH IS TO BE THE SAME AS THAT SHOWN FOR FILL SHOULDER FOR INDEPENDENT GRADING.

*OUTSIDE SHOULDERS*

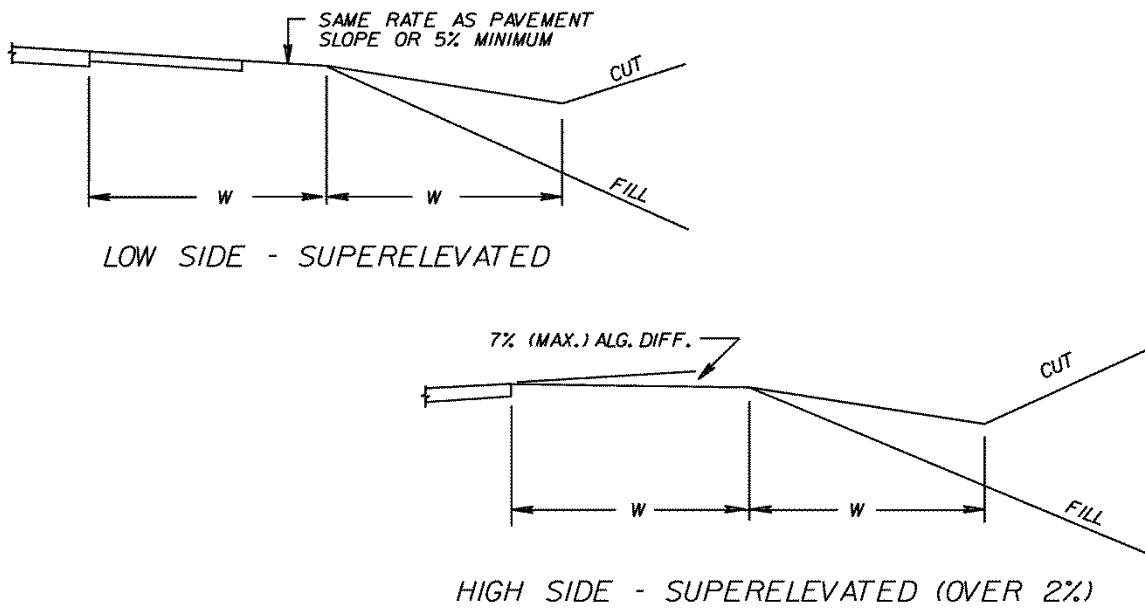

NOTE: FOR WIDTH OF SHOULDERS AND DITCHES (W) SEE GEOMETRIC DESIGN STANDARDS.

STANDARD SHOULDER DESIGN FOR ALL SYSTEMS EXCEPT LOCAL ROADS AND STREETS

**FIGURE A - 1 - 12\***

\* Rev. 7/14

**GEOMETRIC DESIGN STANDARDS FOR SHOULDER DESIGN FOR LOCAL ROAD AND STREETS (GS-12)**

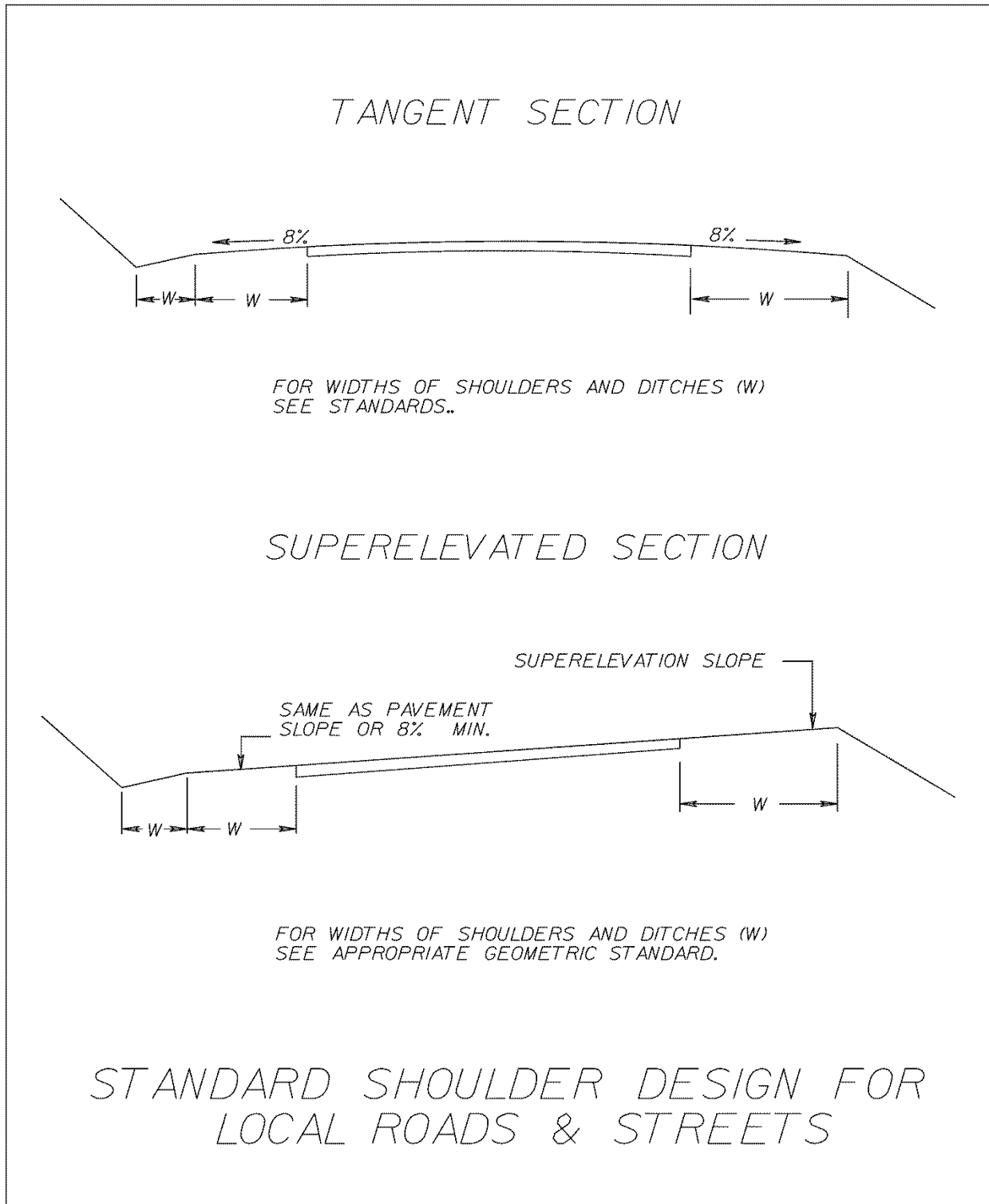

**FIGURE A - 1 - 13\***

\* Added 1/12

**GEOMETRIC DESIGN STANDARDS FOR GRADED MEDIAN DESIGN (GS-13)**

*MEDIAN EDGES OF SHOULDER AT SAME OR APPROXIMATELY SAME ELEVATION*

(GRADING TO CENTER OF MEDIAN)

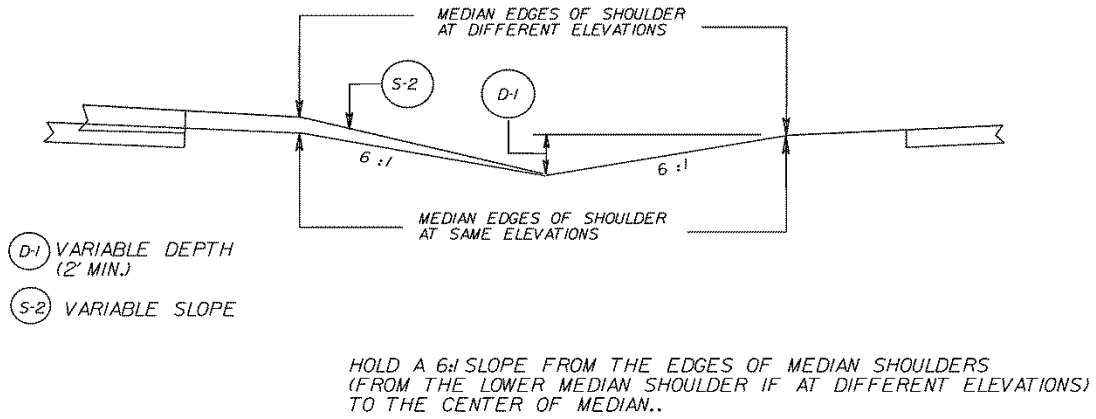

*MEDIAN EDGES OF SHOULDER AT DIFFERENT ELEVATIONS*

(GRADING FROM HIGH SHOULDER TO DITCH ADJACENT TO LOWER ROADWAY)

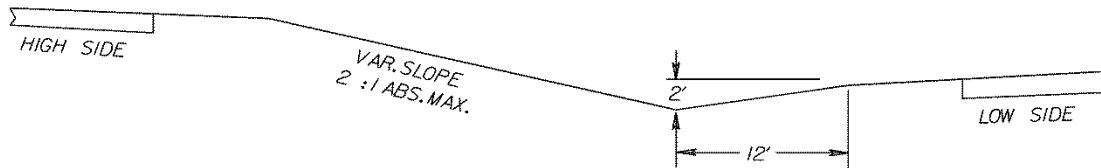

HOLD A 2' DITCH DEPTH, 12' WIDE, ADJACENT TO LOWER SHOULDER.

*STANDARD GRADED MEDIAN DESIGNS*

**FIGURE A - 1 - 14\***

\* Added 1/12

## **SECTION A-2-CLEAR ZONE/LATERAL OFFSET GUIDELINES**

### **INTRODUCTION**

The term “clear zone” is used to describe the unobstructed, traversable area provided beyond the edge of the through traveled way for the recovery of an errant vehicle. The clear zone includes shoulders, bike lanes, parking lanes and auxiliary lanes (except those auxiliary lanes that function like through lanes). Clear zone distances are based upon traffic volume, speed, and embankment slopes.

A recoverable area is to be provided that is clear of all unyielding obstacles such as trees, sign supports, utility poles, light poles, or any other fixed objects that might severely damage an out-of-control vehicle (See 2011 AASHTO *A Policy on Geometric Design of Highways and Streets*, Chapter 5). Determining a practical clear zone often involves a series of compromises between absolute safety, engineering judgment, environmental and economic constraints. Additional information is available in AASHTO's *Roadside Design Guide*.

### **ROADWAYS WITH SHOULDERS**

In rural environments, where speeds are higher and constraints are fewer, a clear zone appropriate for the traffic volume, design speed, and facility type should be provided in accordance with the AASHTO *Roadside Design Guide*, Chapter 3. These values also are applicable for freeways and other controlled-access facilities in urban areas. For an example, see Figure A-2-1, Case 1.

Whenever adequate right of way is available, urban projects should be designed with shoulders in lieu of curbs (unless city ordinances require otherwise) and clear zone widths should be consistent with the requirements for roadways with shoulders. (See 2011\* AASHTO *“A Policy on Geometric Design of Highways and Streets”*, Chapter 7). The justification for providing a curb is to be documented in the project file (e.g. Preliminary Field Inspection Report, recommendation from Right of Way and Utilities Division, etc.).

Roadways\* with paved shoulders should provide as much clear zone as practical in accordance with Table A-2-1, which is from the AASHTO *Roadside Design Guide*. (See 2011 AASHTO *A Policy on Geometric Design of Highways and Streets*, Chapters 4, 5 and 6). For an example, see Figure A-2-1, Case 1.

On projects such as RRR, intersection improvements, etc. recoverable areas are not always practical due to the intent of the project to provide minimal improvements and extend the service life of the existing roadway for a fraction of the costs of reconstruction. However, as much clear zone as practical should be provided.

Sources: *TRB Special Report 214, Designing Safer Roads* / 2011 AASHTO *A Policy on Geometric Design of Highways and Streets*, Chapters 4-7 / 2011 AASHTO *Roadside Design Guide*.

---

\* Rev. 7/16

## ROADWAYS WITH CURB

For urban arterials and other non-controlled access facilities in an urban environment, right of way is often extremely limited. In many cases, establishing a clear zone using the guidance in the *Roadside Design Guide*, Chapter 3 is not practical. These urban environments are often characterized by sidewalks beginning at the back of the curb, enclosed drainage, numerous fixed objects (e.g. signs, utility poles, luminaire supports, fire hydrants, sidewalk furniture), and frequent traffic stops. These environments typically have lower operating speeds and in many instances, on-street parking. In these environments, a lateral offset to vertical obstructions (e.g. signs, utility poles, luminaire supports, fire hydrants), including breakaway devices, is needed to accommodate motorist operating on the highway.

When providing clear zone in accordance with the *Roadside Design Guide* in an urban area is not practical, consideration should be given to establishing as much lateral offset as practical, or incorporating as many clear-zone concepts as practical, such as removing roadside objects or making them crashworthy. Ideally, appurtenances (e.g. benches, trash barrels, bicycle racks) should be located as far away as practical, but at least 4 feet from the face of curb. Breakaway designs shall be used for poles and appurtenances located less than 6 feet from the face of curb. See Figure A-2-1, Case 2 and Figure A-2-1A, Case 3 and Case 4.

Although the clear roadway concept is still the goal, many compromises are likely in urban or restricted environments. A minimum lateral offset of 1.5 feet shall be provided beyond the face of curb, with 3 feet minimum at intersections and driveway openings (10'–15' recommended, See *Roadside Design Guide*, Chapter 10). Note that this minimum lateral offset does not meet clear zone criteria but simply enables normal facility operations by providing clearance for turning trucks, etc. Consideration should be given to providing more than the minimum lateral offset to obstructions by placing fixed objects behind the sidewalk or sidewalk space. See Figure A-2-1, Case 2 and Figure A-2-1A, Case 3.

Note that curb is applicable to roadways with design speeds  $\leq$  45 mph and should be used on roadways  $>$  45 mph only in special situations. These situations may include, but are not limited to drainage considerations, a need for access control and right of way restrictions.

When a vertical drop-off or other hazard (see Appendix J, Section J-3\*, Guardrail Warrants) is located within 6 feet of the face of curb, guardrail should be considered. For instructions on the placement of guardrail adjacent to curb, see Appendix J, Section J-3, Guardrail Installation in Urban Settings.

Any fixed objects (signs, luminaire supports, large trees, etc.) located within a curbed median should not be located less than 6' from the face of curb. See Figure A-2-1A, Case 4.

Source: AASHTO Green Book, Chapter 4, Section 4.7.1, page 4-16 / *Roadside Design Guide*, Chapter 10.

---

\* Rev. 7/18



DESIGN SPEED	DESIGN ADT	FORESLOPES			BACKSLOPES		
		6:1 or Flatter	5:1 to 4:1	3:1	3:1	5:1 to 4:1	6:1 or Flatter
40 mph or less	Under 750 <sup>c</sup>	7-10	7-10	b	7-10	7-10	7-10
	750-1500	10-12	12-14	b	10-12	10-12	10-12
	1500-6000	12-14	14-16	b	12-14	12-14	12-14
	Over 6000	14-16	16-18	b	14-16	14-16	14-16
45-50 mph	Under 750 <sup>c</sup>	10-12	12-14	b	8-10	8-10	10-12
	750-1500	14-16	16-20	b	10-12	12-14	14-16
	1500-6000	16-18	20-26	b	12-14	14-16	16-18
	Over 6000	20-22	24-28	b	14-16	18-20	20-22
55 mph	Under 750 <sup>c</sup>	12-14	14-18	b	8-10	10-12	10-12
	750-1500	16-18	20-24	b	10-12	14-16	16-18
	1500-6000	20-22	24-30	b	14-16	16-18	20-22
	Over 6000	22-24	26-32 <sup>a</sup>	b	16-18	20-22	22-24
60 mph	Under 750 <sup>c</sup>	16-18	20-24	b	10-12	12-14	14-16
	750-1500	20-24	26-32 <sup>a</sup>	b	12-14	16-18	20-22
	1500-6000	26-30	32-40 <sup>a</sup>	b	14-18	18-22	24-26
	Over 6000	30-32 <sup>a</sup>	36-44 <sup>a</sup>	b	20-22	24-26	26-28
65-70 <sup>d</sup> mph	Under 750 <sup>c</sup>	18-20	20-26	b	10-12	14-16	14-16
	750-1500	24-26	28-36 <sup>a</sup>	b	12-16	18-20	20-22
	1500-6000	28-32 <sup>a</sup>	34-42 <sup>a</sup>	b	16-20	22-24	26-28
	Over 6000	30-34 <sup>a</sup>	38-46 <sup>a</sup>	b	22-24	26-30	28-30

Source: AASHTO *Roadside Design Guide*, Chapter 3.

**TABLE A-2-1**

**CLEAR ZONE DISTANCES (IN FEET FROM EDGE OF DRIVING LANE)\***

- When a site specific investigation indicates a high probability of continuing crashes, or when such occurrences are indicated by crash history, the designer may provide clear zone distances greater than the clear zone shown in Table A-2-1. Clear zones may be limited to 30 feet for practicality and to provide a consistent roadway template if previous experience with similar projects or designs indicates satisfactory performance.
- Because recovery is less likely on the unshielded, traversable 3:1 fill slopes, fixed objects should not be present in the vicinity of the toe of these slopes. Recovery of high speed vehicles that encroach beyond the edge of shoulder may be expected to occur beyond the toe of slope. Determination of the width of the recovery area at the toe of slope should take into consideration right of way availability, environmental concerns, economic factors, safety needs, and crash histories. Also, the distance between the edge of the travel lane and the beginning of the 3:1 slope should influence the recovery area provided at the toe of slope. While the application may be limited by several factors, the fill slope parameters which may enter into determining a maximum desirable recovery area are illustrated in FIGURE A-2-4. A 10 foot recovery area at the toe of slope should be provided for all traversable, non-recoverable fill slopes.
- For roadways with low volumes it may not be practical to apply even the minimum values found in Table A-2-1. Refer to Chapter 12 for additional considerations for low volume roadways and Chapter 10 for additional guidance for urban applications in AASHTO *Roadside Design Guide*.
- When design speeds are greater than the values provided, the designer may provide clear zone distances greater than those shown in Table A-2-1.

\* Rev. 1/16

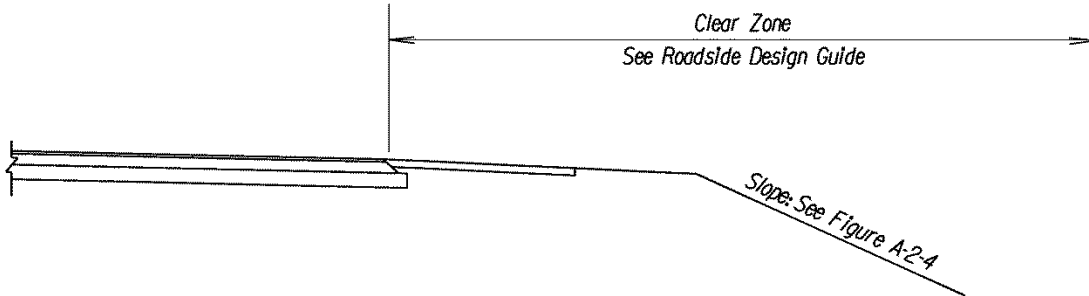

### CASE 1- SHOULDER AND DITCH

\* 1.5' Minimum Lateral Offset in Constrained Low-Speed Urban Environments.

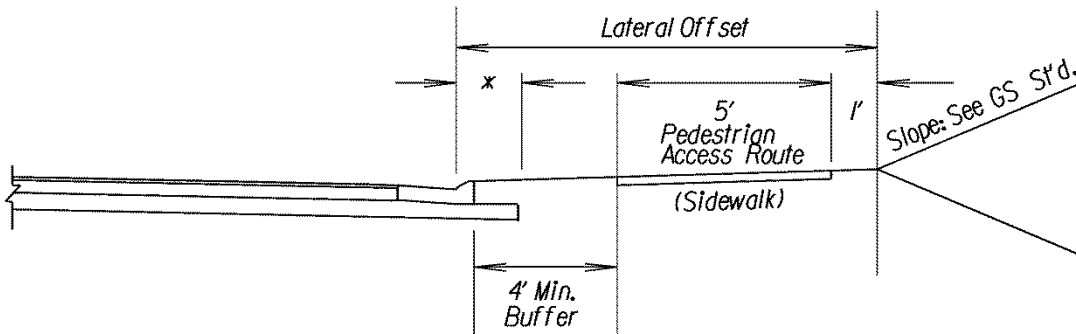

### CASE 2 – CURB WITH BUFFER STRIP AND SIDEWALK

FIGURE A-2-1\*

\* 1.5' Minimum Lateral Offset in Constrained Low-Speed Urban Environments.

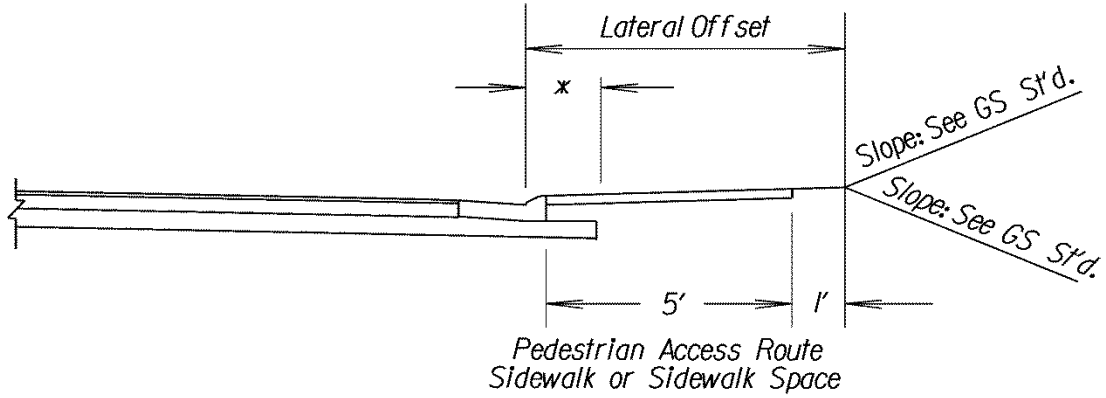

**CASE 3 – CURB SIDEWALK OR SIDEWALK WITH SPACE\***

\* 1.5' Minimum Lateral Offset in Constrained Low-Speed Urban Environments.

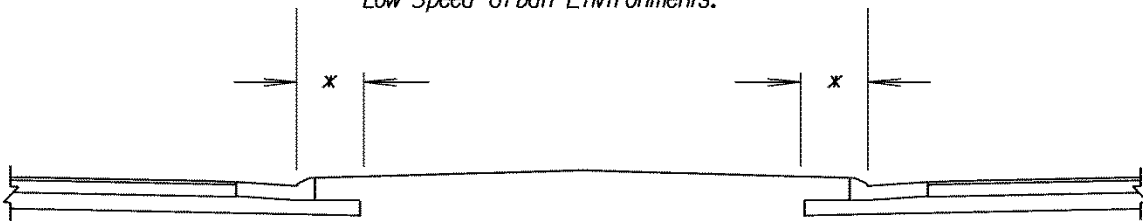

For Additional Considerations  
See Road Design Manual,  
Appendix B(1), Section B(1)-5

**CASE 4 – CURBED MEDIAN**

**FIGURE A-2-1A**

## CLEAR ZONE COST-EFFECTIVENESS ANALYSIS

For projects where the clear zone widths from the AASHTO *Roadside Design Guide* are under consideration, Freeways; Rural and Urban Arterials (with shoulders); and Rural and Urban Collectors (with shoulders) with design speeds of 50 mph or greater and with a design year ADT greater than 2000, an early cost-effectiveness analysis is required to determine the feasibility of providing the recoverable areas to meet the clear zone requirements shown in TABLE A-2-1.

This analysis should be done during the preliminary plan development process and should involve determining the additional construction and R/W costs to provide the desired clear zone. Refer to AASHTO's *Roadside Design Guide*, Chapter 2, for "Economic Evaluation of Roadside Safety".\* Any other procedure which will provide this cost is acceptable as long as it is documented in the project files. After the additional cost to provide the recoverable area is determined, it should be compared to the estimated accident cost without the recoverable area. This cost comparison along with good engineering judgment should be used to determine the feasibility of providing the recoverable areas through the project and should be documented on the Field Review and Scoping Report [PM-100](#).

Prior to establishing the additional construction and R/W cost estimate, the developed areas that would involve heavy R/W damages and/or relocations or environmental restrictions such as park properties, historic areas or wetlands should be noted and where practicable horizontal and vertical alignment adjustments are to be made to provide the desired recoverable areas and clear zones. In these situations alternate designs may include elimination of ditches and/or median width reductions with possible incorporation of raised medians or median barrier to reduce required R/W.

A suggested procedure is shown in FIGURE A-2-2 to develop the difference in cost between the typical section based on the project's functional classification and proper Geometric Design Standards and the typical section with the desired recoverable areas.

---

\* Rev. 1/12

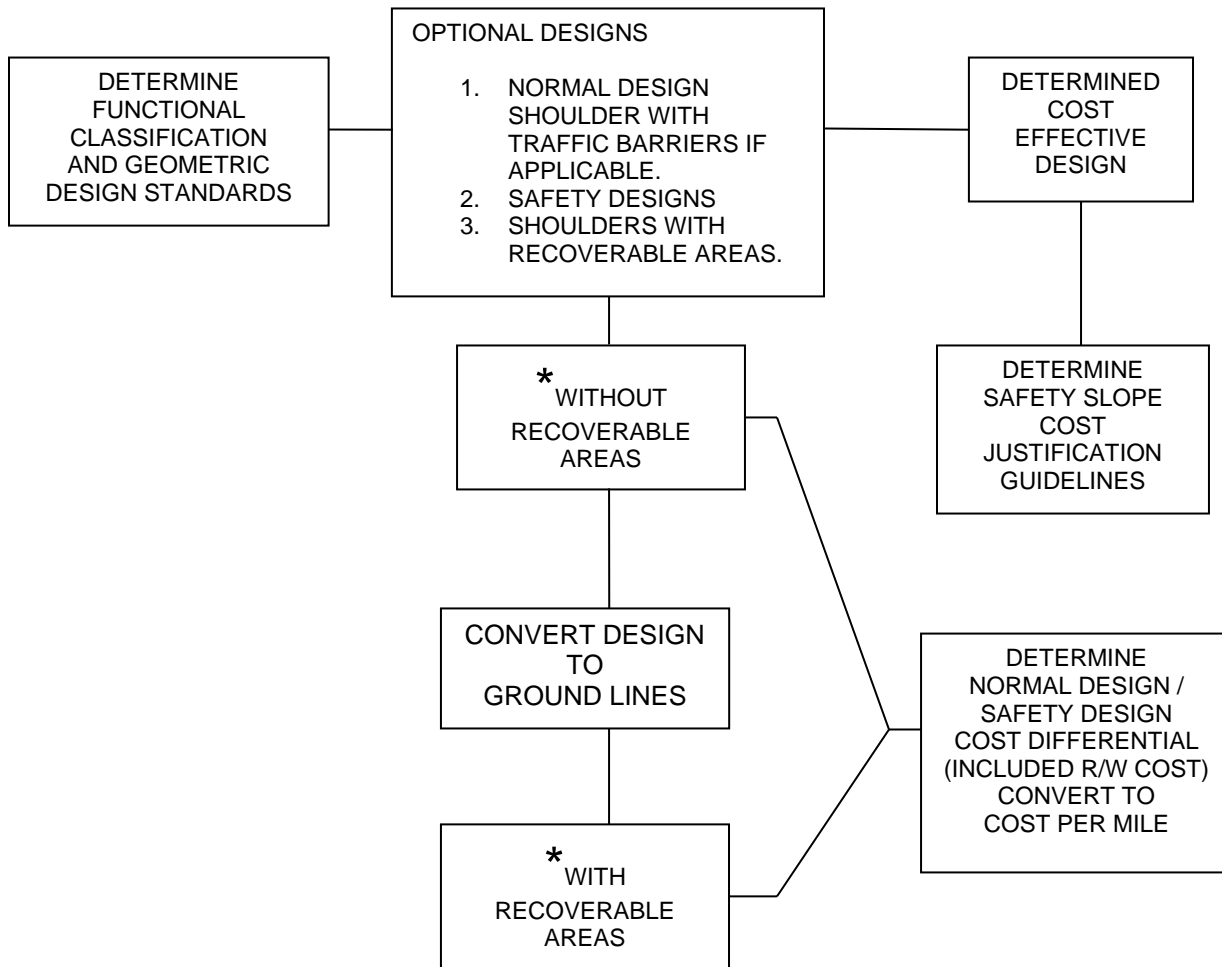

\* GEOPAK DESIGN CROSS SECTION LISTING  
EARTHWORK VOLUME COMPUTATIONS

**FIGURE A-2-2**  
**COST EFFECTIVE SELECTION PROCEDURES**

Note: Upon receipt of normal design and safety design earthwork quantities, a cursory review may indicate that the cost per side for the earthwork alone far exceeds the cost per mile for safety slopes, thereby eliminating the need to determine the other additional costs such as drainage extensions, right of way, etc\*.

**EMBANKMENT SLOPES**

Embankment slopes must have a relatively smooth and firm surface to be truly recoverable or traversable.

---

\* Rev. 7/06

Fill slopes between 3:1 and 4:1 are traversable, but non-recoverable slopes, defined as one from which most motorists will be unable to stop or to return to the roadway easily. Vehicles on such slopes typically can be expected to reach the bottom. Since a high percentage of encroaching vehicles will reach the toe of these slopes, the recovery area cannot logically end on the slope. Fixed obstacles should not be constructed along such slopes and a clear runout area (10' min.) at the base is desirable. FIGURE A-2-4 provides an example of a clear zone computation for non-recoverable slopes.

Any non-traversable hazards or fixed objects, including but not limited to those listed in TABLE A-3-1, which are located within the clear zone as determined from TABLE A-2-1 should preferably be removed, relocated, made yielding, or as a last resort, shielded with a barrier.

### HORIZONTAL CURVE ADJUSTMENTS

The distances in TABLE A-2-1 may be increased on horizontal curves by the values shown in TABLE A-2-2. See the AASHTO *Roadside Design Guide*, Chapter 3 for further instructions.

These modifications are normally considered where crash\* histories indicate such a need, when a specific site investigation shows a definitive crash potential that could be significantly lessened by increasing the clear zone width, and when such increases are cost effective. In these situations, the clear zone distance is increased by the factor in the table below:

RADIUS (ft)	DESIGN SPEED (mph)						
	40	45	50	55	60	65	70
2950	1.1	1.1	1.1	1.2	1.2	1.2	1.2
2300	1.1	1.1	1.2	1.2	1.2	1.2	1.3
1970	1.1	1.2	1.2	1.2	1.3	1.3	1.4
1640	1.1	1.2	1.2	1.3	1.3	1.3	1.4
1475	1.2	1.2	1.3	1.3	1.4	1.4	1.5
1315	1.2	1.2	1.3	1.3	1.4	1.4	-
1150	1.2	1.2	1.3	1.4	1.5	1.5	-
985	1.2	1.3	1.4	1.5	1.5	-	-
820	1.3	1.3	1.4	1.5	-	-	-
660	1.3	1.4	1.5	-	-	-	-
495	1.4	1.5	-	-	-	-	-
330	1.5	-	-	-	-	-	-

**TABLE A-2-2**

Source: AASHTO *Roadside Design Guide*, Chapter 3

$$CZ_c = (L_c) (K_{cz})$$

Where

$CZ_c$  = clear zone on outside of curvature, ft.

$L_c$  = clear zone distance ft., Table A-2-1

$K_{cz}$  = curve correction factor

Note: Clear zone correction factor is applied to outside of curves only. Curves flatter than 2950 feet don't typically require an adjusted clear zone.

\* Rev. 1/12

## SHOWING CLEAR ZONES/ LATERAL OFFSETS ON TYPICAL SECTIONS

The clear zone width(s) shall be clearly shown on the project typical sections if traversable slopes are being provided so that other divisions will be aware of the desirable clear zones for a project. When varying clear zone widths occur, furnish station to station breakdown. Following are typical methods of showing clear zone/lateral offset\* data on typical sections.

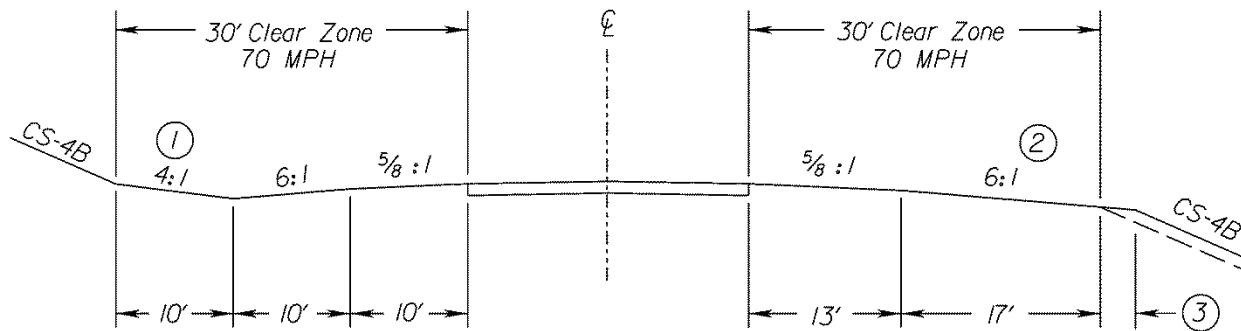

### EXAMPLE OF A TYPICAL RURAL SECTION

(Other Principal Arterial - Std. CS- 4B used for example)

Design ADT > 6000

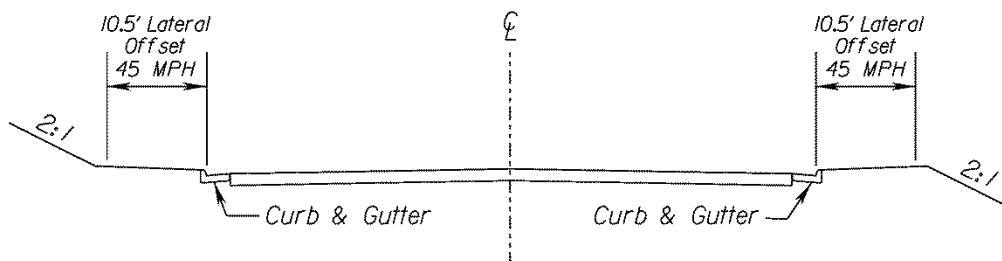

### EXAMPLE OF A TYPICAL URBAN SECTION

(Minor Arterial Street used for example)

## TYPICAL METHOD OF SHOWING CLEAR ZONE/ LATERAL OFFSET DATA ON TYPICAL SECTIONS

### NOTES:

1. If the front slope of ditch is 6:1, the back slope should be 4:1, and if the front slope is 3:1, the back slope should be flat.
2. The preferred slope for recoverable areas with fills is 6:1 or flatter.
3. Width to be increased 3' when Guardrail is required.

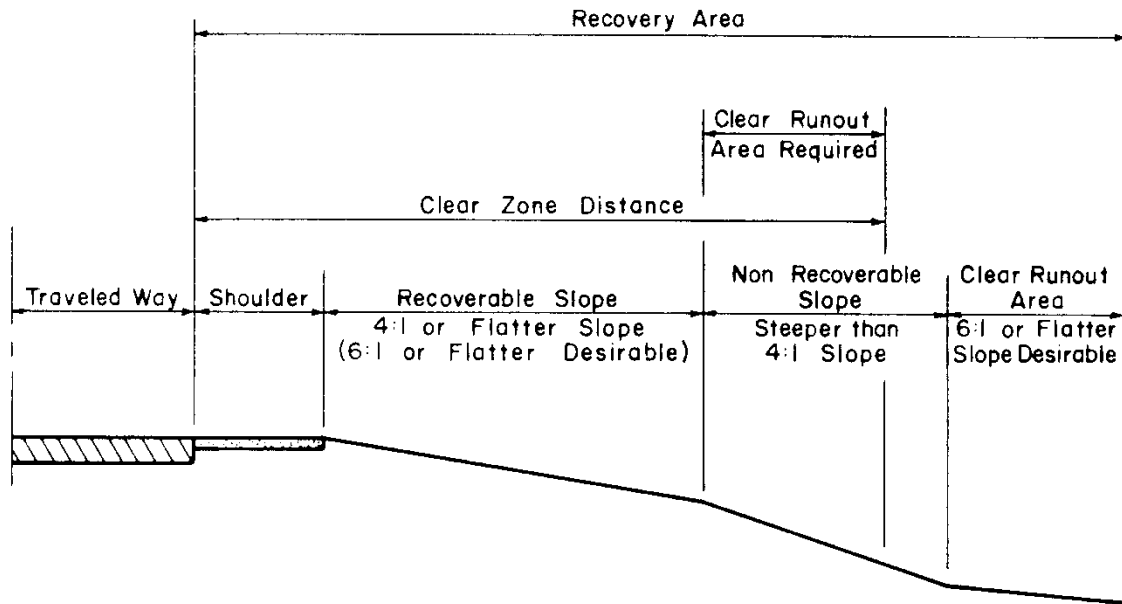

**FIGURE A-2-4 EXAMPLE OF A PARALLEL EMBANKMENT SLOPE DESIGN**

Source: AASHTO *Roadside Design Guide*, Chapter 3

This figure illustrates a recoverable slope followed by a non-recoverable slope. Since the clear zone distance extends onto a non-recoverable slope, the portion of the clear zone distance on such a slope may be provided beyond the non-recoverable slope if practical. This clear runout area would then be included in the total recovery area. The clear runout area may be reduced in width based on existing conditions or site investigations. Such a variable slope typical section is often used as a compromise between roadside safety and economics. By providing a relatively flat recovery area immediately adjacent to the roadway, most errant motorists can recover before reaching the steeper slope beyond. The slope break may be liberally rounded so an encroaching vehicle does not become airborne. It is suggested that the steeper slope be made as smooth as practical and rounded at the bottom.



## NON-RECOVERABLE PARALLEL SLOPES

Foreslopes\* from 3:1 up to 4:1 are considered traversable if they are smooth and free of fixed object hazards. However, since many vehicles on slopes this steep will continue on to the bottom, a clear run-out area beyond the toe of the slope is desirable. The extent of this clear run-out area could be determined by first finding the available distance between the edge of the through traveled way and the breakpoint of the recoverable foreslope to the non-recoverable foreslope. This distance is then subtracted from the total recommended clear zone distance based on the slope that is beyond the toe of the non-recoverable foreslope and should be at least 10' if practicable. The result is the desirable clear run-out area. The following example illustrates this procedure:

### EXAMPLE

Design ADT: 7000

Design Speed: 60 mph

Recommended clear zone distance for the 8:1 slope: 30-32 feet (from  
TABLE A-2-1)

Recovery distance before breakpoint of non-recoverable foreslope: 17 feet

Clear run-out area at toe of slope: 30-32 feet minus 17 feet or 13-15 feet

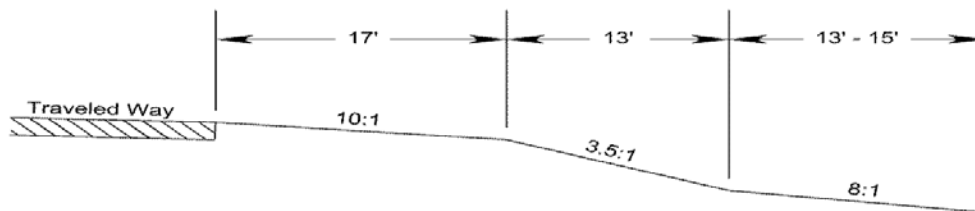

(For Example of Alternate Design to reduce CZ requirement, see below)

Discussion: Using the steepest recoverable foreslope before or after the non-recoverable foreslope, a clear zone distance is selected from Table A-2-1. In this example, the 8:1 slope beyond the base of the fill dictates a 30-32 foot clear zone area. Since 17 feet is available at the top, an additional 13-15 feet could be provided at the bottom. Since this is less than the 10' recovery area that should be provided at the toe of all the non-recoverable slopes, the 10' should be applied. All foreslope breaks may be rounded and no fixed objects would normally be built within the upper or lower portions of the clear zone or on the intervening foreslope.

The designer may find it safe and practical to provide less than the entire 13-15 feet at the toe of the slope. A smaller recovery area could be applicable based on the rounded slope breaks, the flatter slope at the top or past accident histories. A specific site investigation may be appropriate in determining an appropriate recovery area at the toe of the slope.

\* Rev. 7/13

**EXAMPLE OF ALTERNATE DESIGN (INCORPORATING MINOR SLOPE ADJUSTMENT)  
TO REDUCE TOTAL CLEARANCE REQUIREMENT:**

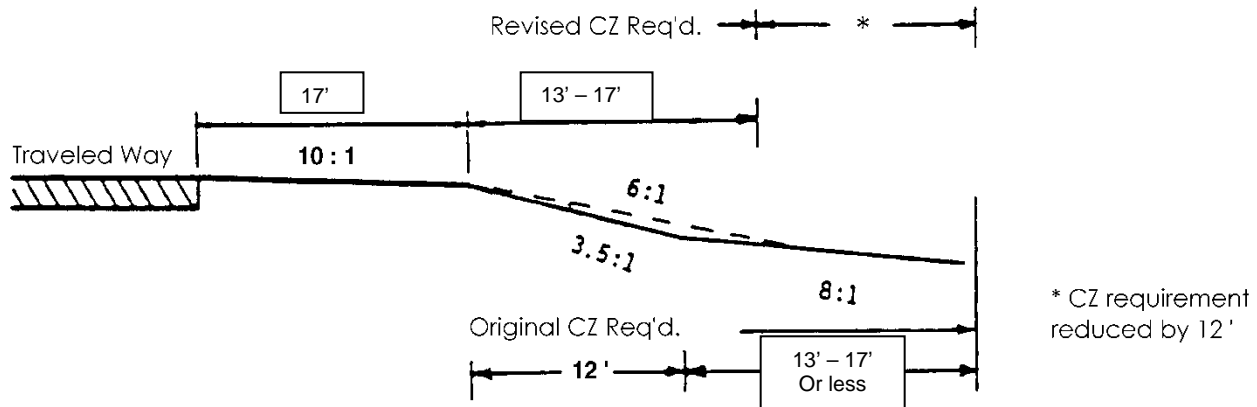

Source: *Roadside Design Guide*, Chapter 3

When traffic barriers must be provided because hazardous conditions cannot be eliminated, see Appendix J\* - Barrier Installation Criteria.

## **SECTION A-3- INNOVATIVE INTERSECTION AND INTERCHANGE DESIGN GUIDELINES**

Below are examples of Innovative Intersection and Interchange Control Types that VDOT currently recognizes as effective traffic control treatments: \*

### **CURRENT VDOT INNOVATIVE INTERSECTION AND INTERCHANGE CONTROL TYPES**

#### **Intersections**

- Displaced Left-Turn (DLT)
- Median U-Turn (MUT)
- Restricted Crossing U-Turn (RCUT)
- Continuous Green-T (CGT)
- Quadrant Roadway (QR)
- Jug-handle
- Roundabouts

#### **Interchanges**

- Diverging Diamond Interchange (DDI)
- Single Point Urban Interchange
- Double Roundabout Interchange

Other Innovative Intersection and interchange designs may be developed in the future and will be listed in this Appendix.

For more information on the above mentioned Innovative Intersection Designs see:

[http://www.virginiadot.org/info/alternative\\_intersection\\_informational\\_design\\_guides.asp](http://www.virginiadot.org/info/alternative_intersection_informational_design_guides.asp)  
[https://safety.fhwa.dot.gov/intersection/alter\\_design/](https://safety.fhwa.dot.gov/intersection/alter_design/)

---

\* Added 7/17

## INNOVATIVE INTERSECTION DESIGN GUIDELINES\*

### DISPLACED LEFT-TURN INTERSECTION (DLT) – (Also known as Continuous Flow Intersection (CFI), Crossover Displaced Left-Turn Intersection)

Any intersection form relocating one or more left-turn movements on an approach to the other side of the opposing traffic flow.

- Allows left-turn movements to proceed simultaneously with the through movement.
- Eliminates the left turn phase for this approach.
- Reduces the number of traffic signal phases and conflict points (locations where user paths cross).
- Can result in improvements in traffic operations and safety performance
- Green time can be reallocated to facilitate pedestrian crossings

For more information on the above mentioned Innovative Intersection Designs see:

[http://www.virginiadot.org/FHWA-SA-14-041DLTInformationalBrochure\\_1.pdf](http://www.virginiadot.org/FHWA-SA-14-041DLTInformationalBrochure_1.pdf)

<http://www.virginiadot.org/FHWA-SA-14-068DLTInformationalGuide.pdf>

## Overview: Displaced Left-Turn Intersection

- Four-legged DLT with displaced lefts on a major street

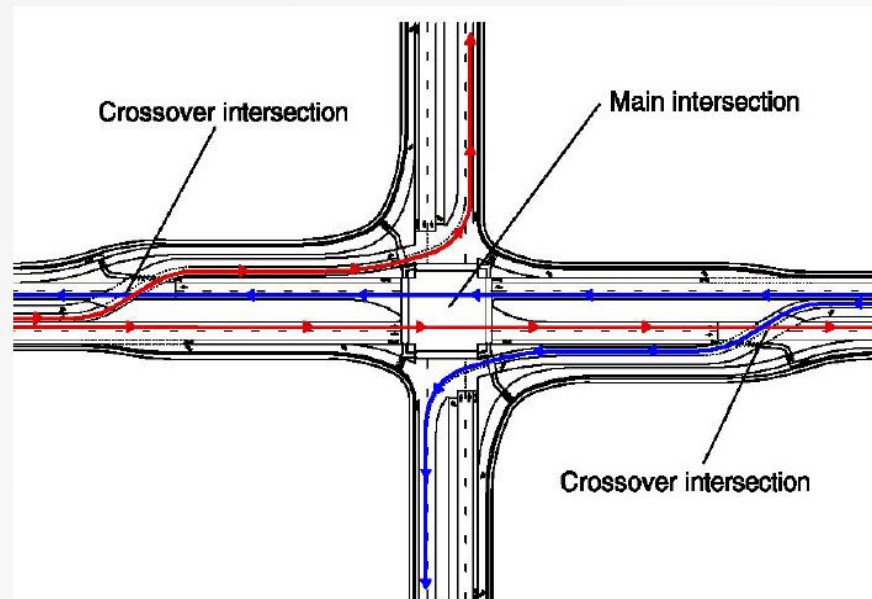

\* Added 7/17

**MEDIAN U-TURN INTERSECTION (MUT)** – (Also Known as Median U-Turn Crossover, Boulevard Turnaround, Michigan Loop and ThrU-Turn Intersection).\*

- Replaces all direct left turns at an intersection with indirect left turns using a U-turn movement in a wide median.
- Eliminates left turns on both intersecting side streets and the major street.
- Reduce the number of traffic signal phases and conflict points - May result in improved intersection operations and safety.
- Can also utilize unsignalized median U-turns.
- Distance of the secondary intersections from the main intersection should provide adequate taper and storage length for vehicles, signing, and sight distance. Recommend spacing the secondary intersections  $\pm 660$  feet from the main intersection.

For more information on the above mentioned Innovative Intersection Designs see:

[http://www.virginiadot.org/FHWA-SA-14-042\\_MUT\\_Informational\\_Brochure.pdf](http://www.virginiadot.org/FHWA-SA-14-042_MUT_Informational_Brochure.pdf)

[http://www.virginiadot.org/FHWA-SA-14-069\\_MUT\\_Informational\\_Guide.pdf](http://www.virginiadot.org/FHWA-SA-14-069_MUT_Informational_Guide.pdf)

## Median U-Turn Intersection

- MUT with signals at the main intersection and two crossover locations
- MUT may also have signals at the main intersection but unsignalized crossovers

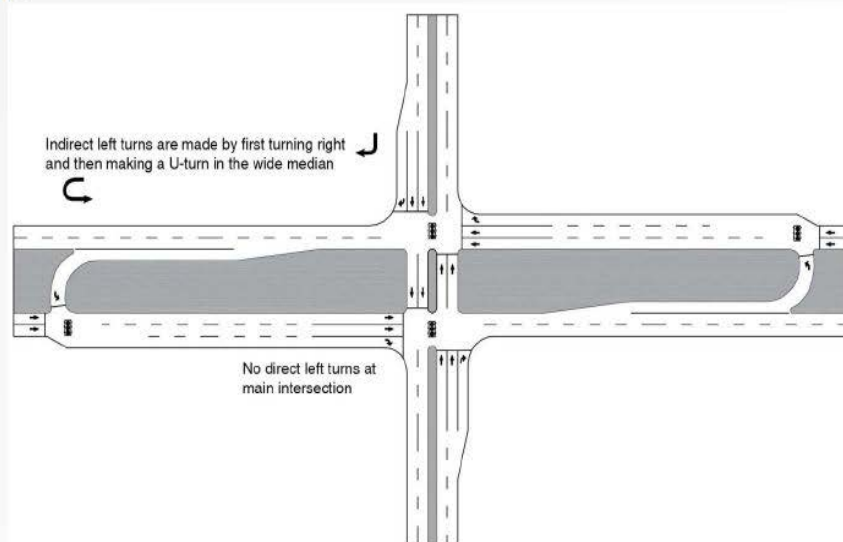

\* Added 7/17

## RESTRICTED CROSSING U-TURN INTERSECTION (RCUT) – (Also known as Superstreet Intersection, J-Turn Intersection and Synchronized Street Intersection)\*

- Replaces side street direct left turns at an intersection with indirect left turns using a U-turn movement in a wide median.
- Eliminates left turns on both intersecting side streets. Left turns are provided on the major street.
- Can be signalized or unsignalized.
- Reduce the number of traffic signal phases and conflict points. When implemented as a corridor treatment, almost perfect signal progression is possible as the main intersection can be operated as two separate signals with the two major street direction phases operating independently of each other.
- Will usually result in improved intersection operations and safety.
- Distance of the secondary intersections from the main intersection should provide adequate taper and storage length for vehicles, signing, and sight distance. Recommend spacing the secondary intersections  $\pm 660$  feet from the main intersection.

For more information on the above mentioned Innovative Intersection Designs see:  
[http://www.virginiadot.org/FHWA-SA-14-040\\_RCUT\\_Informational\\_Brochure.pdf](http://www.virginiadot.org/FHWA-SA-14-040_RCUT_Informational_Brochure.pdf)  
[http://www.virginiadot.org/info/alternative\\_intersection\\_informational\\_design\\_guides.asp](http://www.virginiadot.org/info/alternative_intersection_informational_design_guides.asp)  
[https://safety.fhwa.dot.gov/intersection/alter\\_design/](https://safety.fhwa.dot.gov/intersection/alter_design/)

## Restricted Crossing U-Turn Intersection

- Three types of RCUT intersections
  - Signalized (shown below)
  - Stop-controlled
  - Merge- or yield-controlled

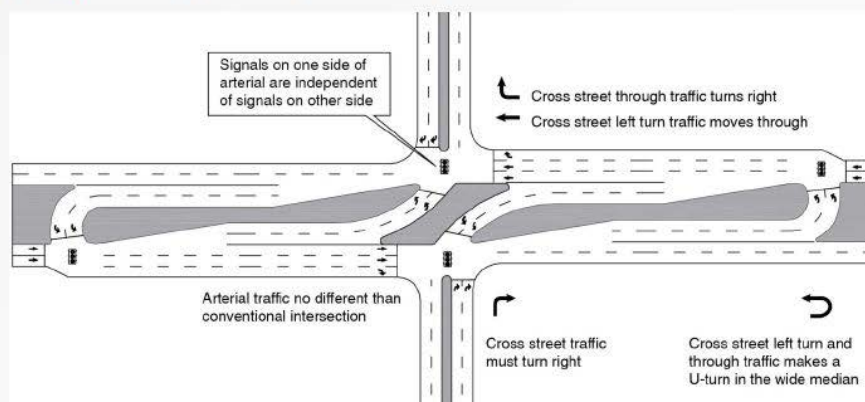

\* Added 7/17

## CONTINUOUS GREEN-T (CGT)\*

The design provides free-flow operations in one direction on the major street and can reduce the number of approach movements that need to stop to three by using free-flow right turn lanes on the arterial and cross streets and acceleration/merge lanes for left turn movements from the cross street. Physical separation or barrier is typically required between the acceleration/merge lanes and the mainline free flow movement.

For more information on the above mentioned Innovative Intersection Designs see:

<https://www.fhwa.dot.gov/publications/research/safety/16036/16036.pdf>

<https://safety.fhwa.dot.gov/intersection/innovative/others/casestudies/fhwasa09016/fhwasa09016.pdf>

[https://attap.gitbooks.io/muid/content/at-grade\\_&\\_signalized/continunous\\_green-t.html](https://attap.gitbooks.io/muid/content/at-grade_&_signalized/continunous_green-t.html)

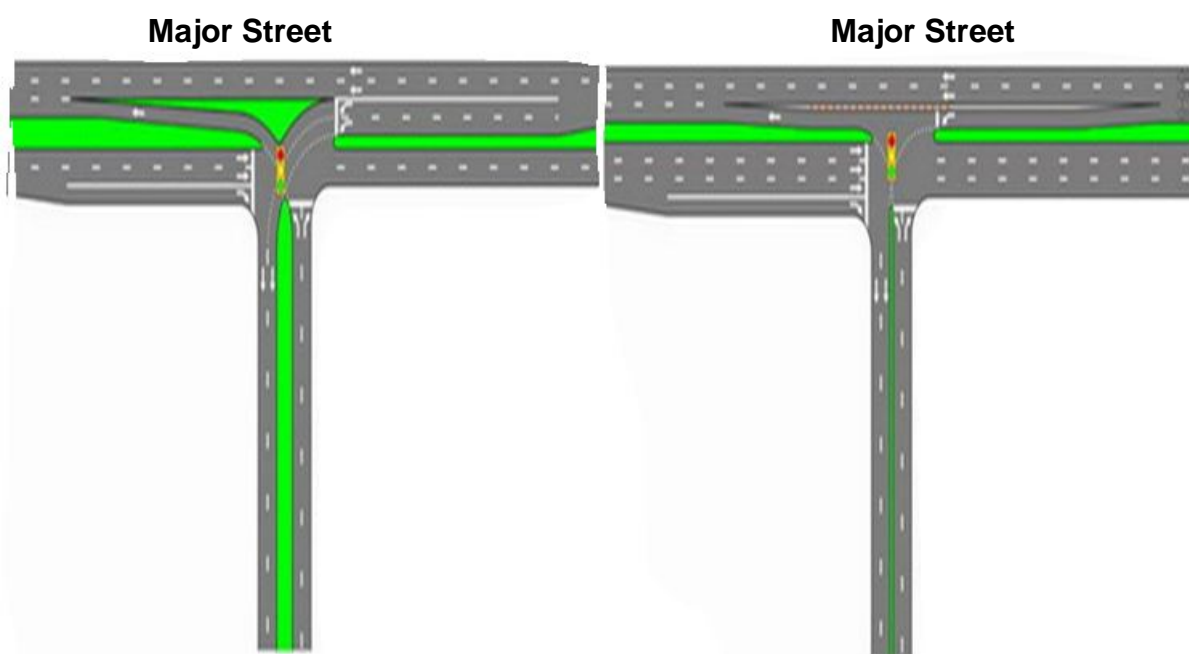

---

\* Added 7/17

## QUADRANT ROADWAY INTERSECTION (QR)\*

### Geometric Design

The primary design considerations of the QR intersection are as follows:

- Left turns are not permitted at the main intersection.
- The location of the connector road should be primarily determined by the left-turn volume at the intersection.

U-turns are not permitted at the main intersection and are rerouted similar to left turns.

- Distance of the secondary intersections from the main intersection should provide adequate taper and storage for vehicles, signing, and sight distance. Recommend spacing the secondary intersections  $\pm 660$  feet from the main intersection.
- If permitted, driveways from the connecting road to the parcel inside the connecting road may be placed in the curve of the connecting road or near one of the secondary intersections. If driveways are not permitted, then the parcel inside the connecting roadway can be accessed via driveways off one or both of the intersecting streets.

At a QR intersection, some pedestrians will need to cross an extra street; however, others who follow the curved connection roadway or the main intersection crosswalks will have shorter walking distances. Also, the shorter cycle lengths at QR intersections benefit pedestrians.

A QR with more than one connection road can be implemented if right-of-way is available and if left-turn volumes justify it. Geometric principles remain largely the same for QRs with one or more connection roadways.

### Applicability

They are most applicable where the following exists:

- A roadway in the road network can be used as a connection roadway.
- There are heavy left turns and through volumes on the major and minor roads.
- The minor road total volume to total intersection volume ratio is typically less than or equal to 0.35.

---

\* Added 7/17

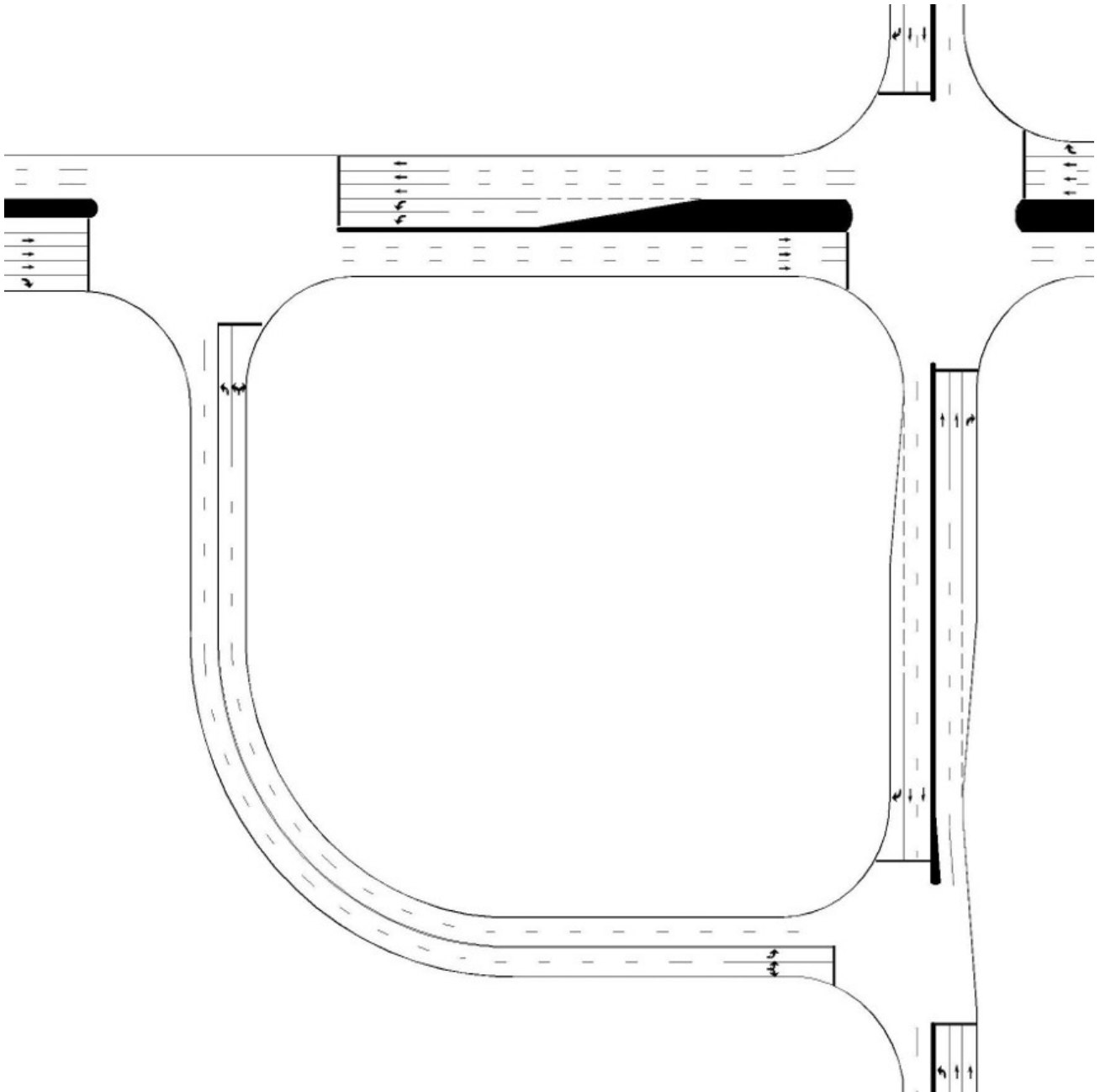

**QUADRANT ROADWAY INTERSECTION\***

For more information on the above mentioned Innovative Intersection Designs see:  
<https://www.fhwa.dot.gov/publications/research/safety/09058/09058.pdf>  
<https://www.fhwa.dot.gov/publications/research/safety/09058/>

---

\* Added 7/17

**JUG-HANDLE\***

A jug-handle is a type of ramp or slip road that changes the way traffic turns left at an at-grade intersection. Instead of a standard left turn being made at the intersection from the left lane, left-turning traffic uses a ramp or slip road on the right side of the road.

Jug-handles are common in many states including New Jersey, Connecticut, Delaware, Oregon, and Pennsylvania.

Drivers wishing to turn left exit the major roadway at a ramp or slip road on the right, and turn left onto the minor road at a terminus separated from the main intersection.

For more information on the above mentioned Innovative Intersection Designs see:

<https://www.fhwa.dot.gov/publications/research/safety/07032/>

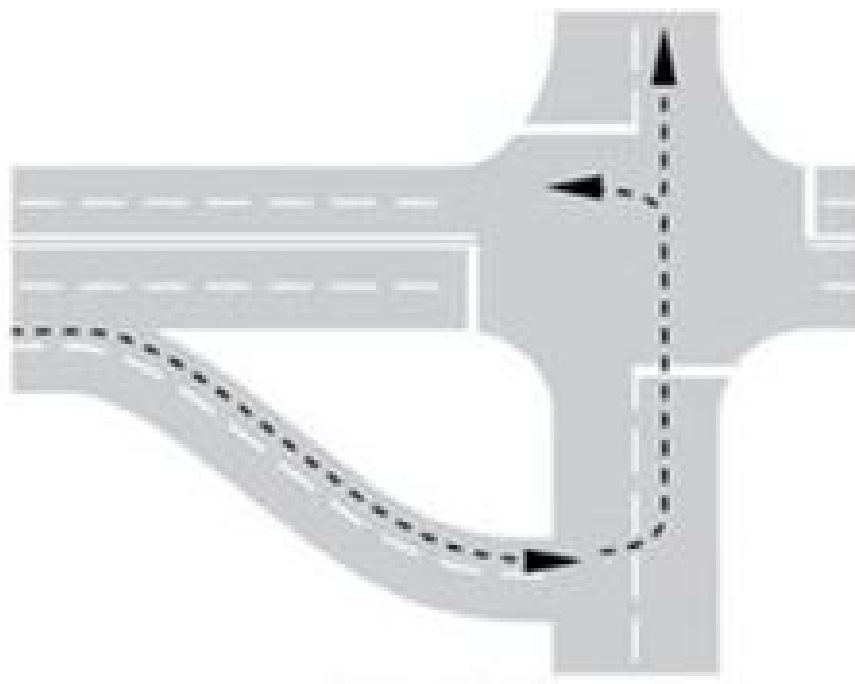

---

\* Added 7/17

## ROUNDABOUTS

Roundabouts are circular intersections with specific design and traffic control features. These include yield control of all entering traffic (circulating vehicles have the right-of-way), channelized approaches, and geometric curvature to ensure that travel speeds are typically less than 30 mph (single-lane 20-25 mph; two-lane 25-30 mph).

Roundabouts are generally safer than other types of intersections for low and medium traffic conditions. These safety benefits are achieved by eliminating vehicle crossing movements through the conversion of all movements to right turns and by requiring lower speeds as motorists proceed into and through the roundabout. The potential for right angle and left turn head-on crashes is eliminated with single lane roundabouts. Roundabouts treat all vehicle movements equally, each approach is required to yield to circulating traffic. Roundabouts typically handle higher volumes with lower vehicle delays (queue) than traditional intersections at capacity.

While roundabouts usually require more right-of-way at an intersection compared to a traffic signal, they require less right-of-way on the upstream approaches and downstream exits. At new intersection sites that will require turn lanes, a roundabout can be a less expensive intersection alternative. Operating and maintenance costs are less than signalized intersections since there is no signal equipment. The roundabout has aesthetic advantages over other intersection types particularly when the central island is landscaped.

VDOT has adopted the NCHRP Report 672 Roundabouts: An Informational Guide, 2<sup>nd</sup> Edition as our design guide. However, design criteria mentioned in this Manual takes precedence over NCHRP Report 672.\*

---

\* Rev. 1/18

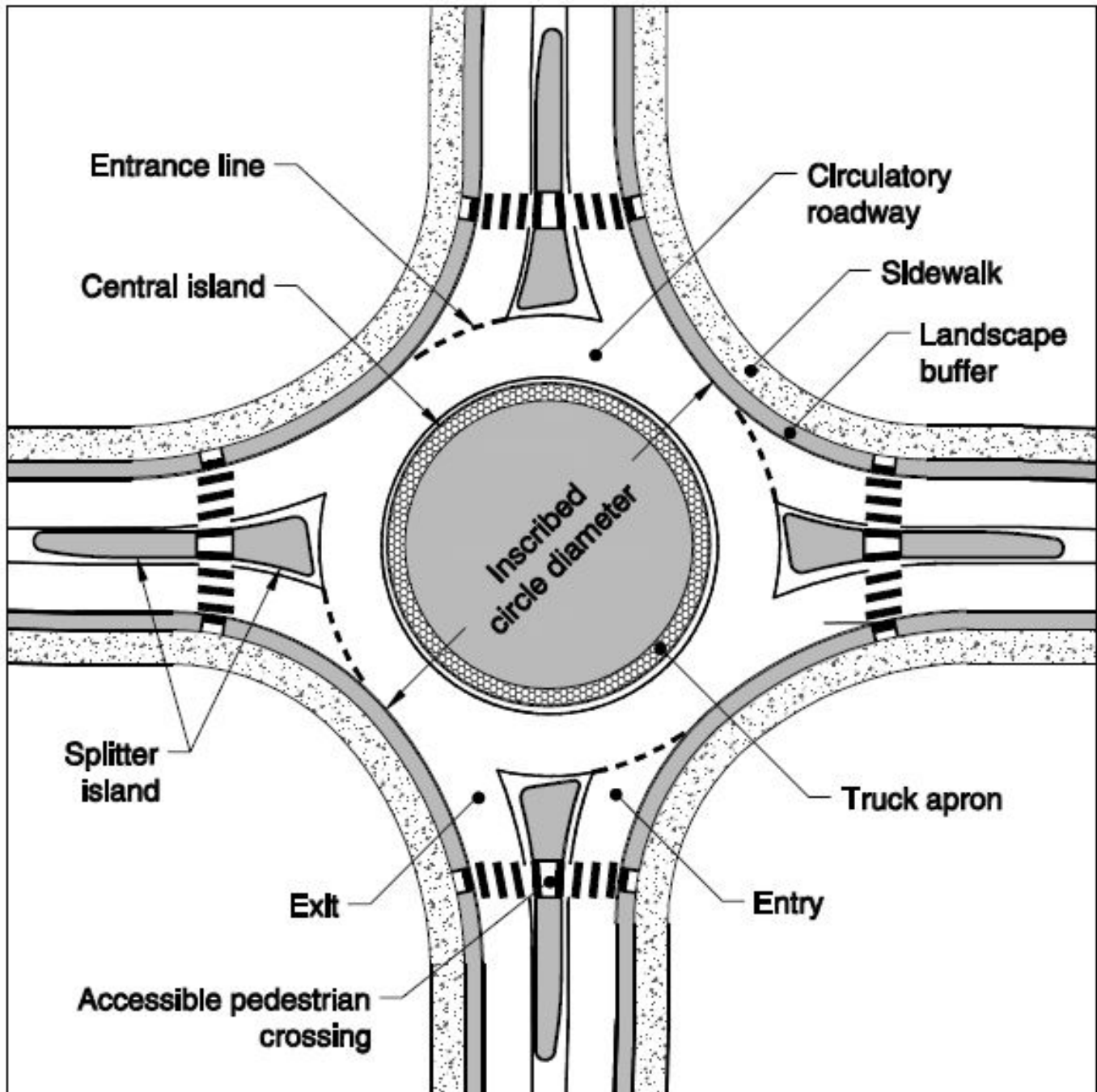

**FIGURE A-3-1 ROUNDABOUT DESIGN ELEMENTS**

Source: [NCHRP Report 672 Roundabouts: An Informational Guide, Second Edition](#).\*

For Truck Apron Curb use cell Mod. CG-3 found in the cell library.\*

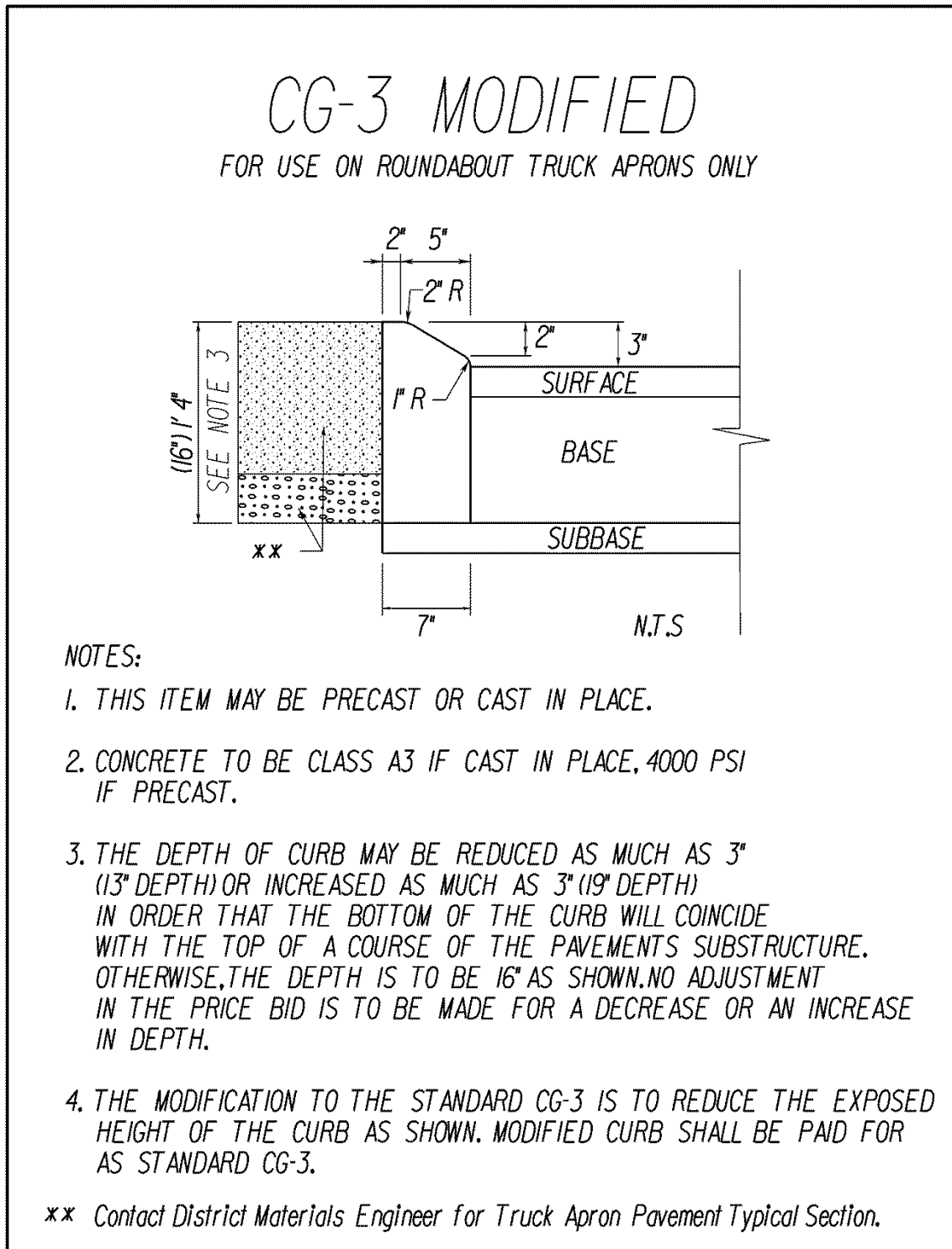

**FIGURE A-3-2 ROUNDABOUT TRUCK APRON CURB DETAIL**

There are three basic categories of roundabouts based on size and number of lanes: mini-roundabouts, single-lane roundabouts and multi-lane roundabouts.

## MINI-ROUNDBABOUTS

Mini-Roundabouts are applicable in urban environments with speeds less than or equal to 30 mph. They adapt to existing boundaries by providing a fully traversable central island, a mini-roundabout can be a low-cost solution for improving intersection capacity and safety without the need for acquiring additional right of way. The suitability of a mini-roundabout depends on:

- 1) Traffic Volumes (comparable ADT from each approach roadway)
- 2) Truck Volumes < 5%
- 3) Frequency of School Bus use

Mini-Roundabouts should meet the following geometric design criteria:

- 1) Central island of 25 to 50 feet, which is fully mountable
- 2) Central island curb height is less than 2 inches high and is often flush and painted
- 3) Central island should be domed using 5% - 6% cross slope, with maximum height of 5 inches\*
- 4) Circular roadway width of 12 feet (may be wider for intersections with acute angles)
- 5) Approach lanes 10 to 11 feet (to reduce speeds)

Mini-Roundabouts are designed with painted “splitter islands” in each quadrant to guide traffic. The majority of traffic (usually estimated at 97%) should be able to pass through the mini-roundabout while staying within the circular roadway. The traversable central island and splitter islands allow larger vehicles to pass through. Mini-Roundabouts can conservatively handle 1,600 VPH (all approaches) while providing an adequate level of service.

Sources: ITE Journal, November 2012, Article by Lochrane, Zhang and Bared;  
Public Roads Magazine, Nov. /Dec. 2012, “They’re Small But Powerful” at:  
[NCHRP Report 672, Roundabouts: An Informational Guide](#), Second Edition,  
Chapter 6, Section 6.6

---

\* Rev. 7/18

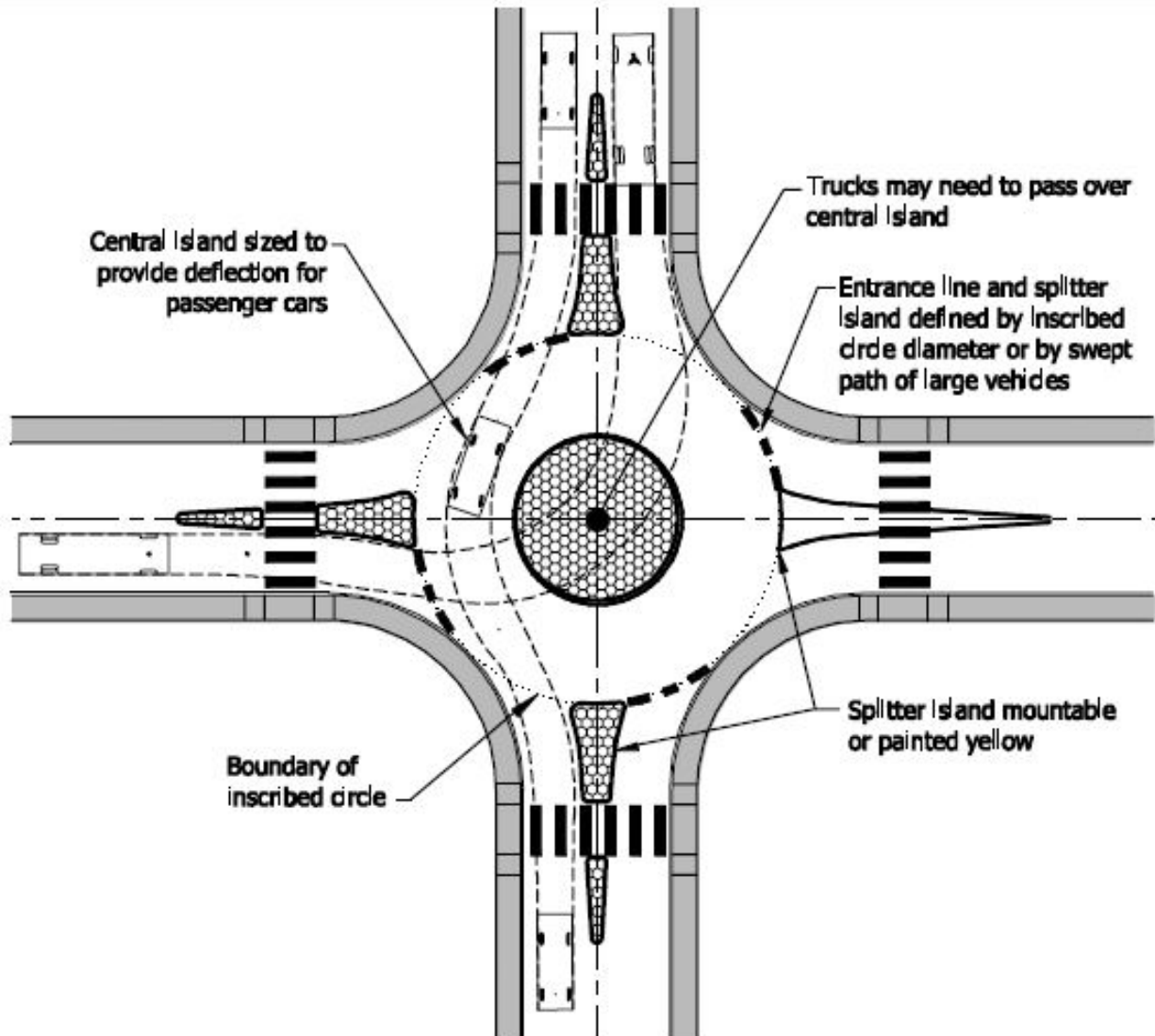

Features of a Typical Mini-Roundabout\*

Source: [NCHRP Report 672 Roundabouts: An Informational Guide, Second Edition](#).

\* Rev. 7/17

## SINGLE-LANE ROUNDABOUTS\*

- Single-Lane Roundabouts have single-lane entry at all legs and one circulating lane. They are distinguished from mini-roundabouts by their larger inscribed circle diameter and non-traversable central island. The geometric design features include: raised splitter islands with appropriate entry path deflection, a raised non-traversable central island, crosswalks, and a truck apron vertically separated by a VDOT CG-3 Modified curb from the circulatory roadway.
- The maximum daily service volume of a single-lane roundabout varies between 20,000 and 26,000 vehicles per day (2,000 - 2,600 peak hour volume), depending on the left turn percentages and the distribution of traffic between the major and minor roads.

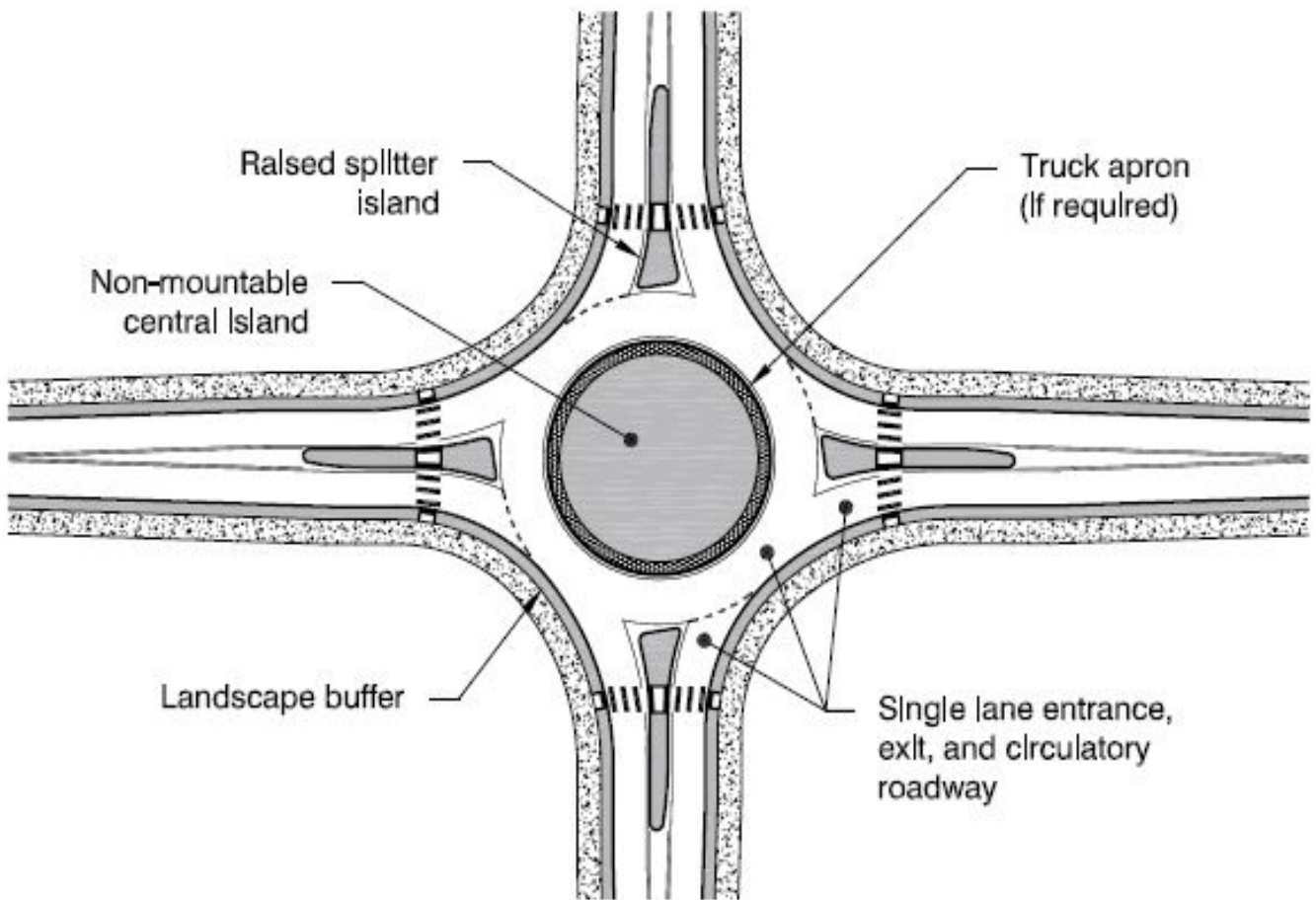

Features of a Typical Single-Lane Roundabout

Source: [NCHRP Report 672 Roundabouts; An Informational Guide, Second Edition](#).

\* Rev. 7/17



## MULTI-LANE ROUNDABOUTS\*

- Multi-Lane Roundabouts have at least one entry with two or more circulating lanes. In some cases, the roundabout may have a different number of lanes on one or more approaches (e.g., two-lane entries on the major street and one-lane entries on the minor street). They may have entries on one or more approaches that flare from one to two or more lanes. They also require wider circulating roadways to accommodate more than one vehicle traveling side by side. The geometric design features include: raised splitter islands with appropriate entry path deflection, a raised non-traversable central island, crosswalks, and a truck apron separated by a VDOT CG-3 Modified curb from the circulatory roadway. Driver decisions are more complex for multi-lane roundabouts. These decisions include: proper lane when entering, lateral positioning while circulating and proper lane for exiting.
- If a Multi-Lane Roundabout design is warranted in the long term, it should be designed as a Multi-Lane Roundabout, but striped and signed as a Single-Lane Roundabout when initially opened to traffic.

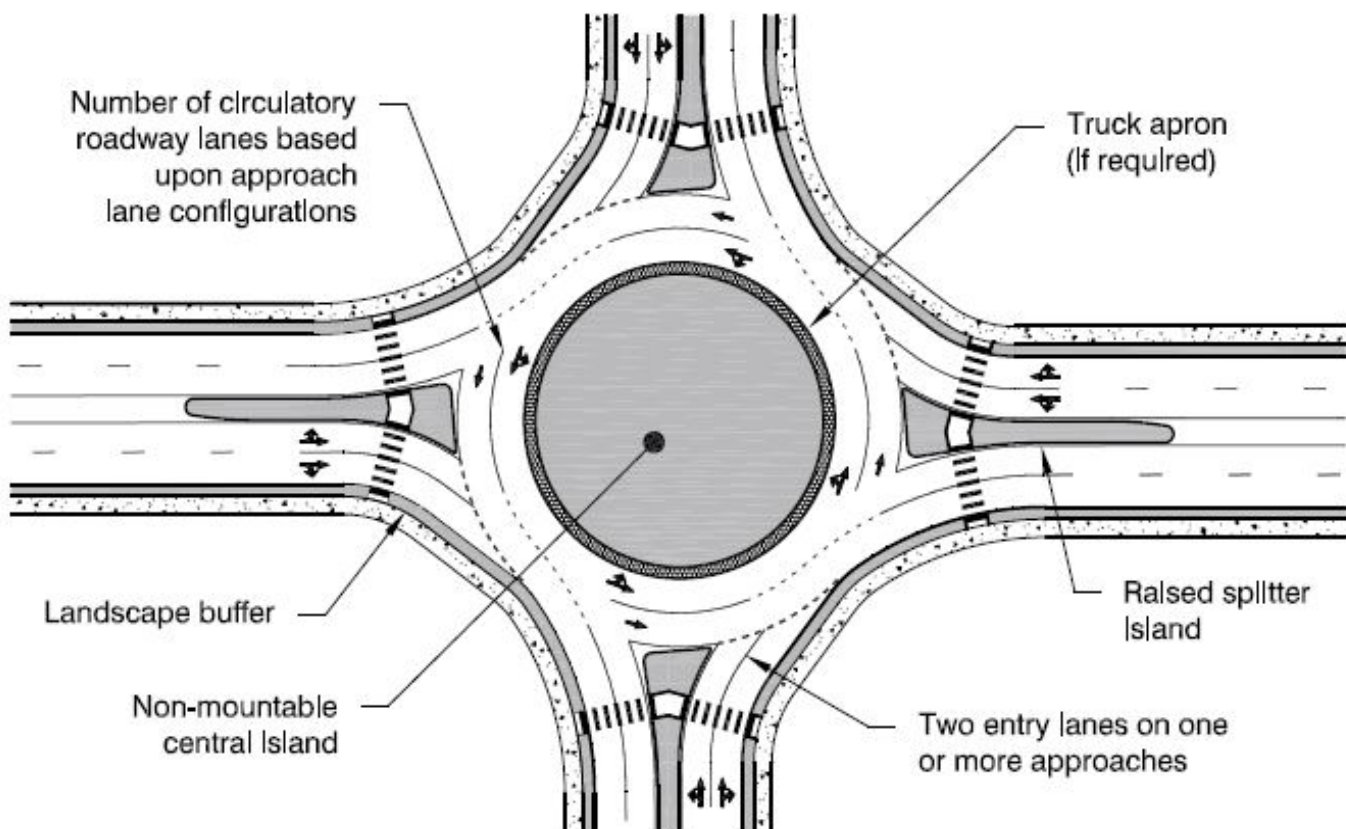

Features of a Typical Multi-Lane Roundabout

Source: [NCHRP Report 672 Roundabouts; An Informational Guide, Second Edition.](#)

## GEOMETRIC DESIGN CRITERIA FOR SINGLE-LANE AND MULTI-LANE ROUNDABOUTS

- Central Island, **shall be raised** (non-mountable) and sloped outward away from the center. The island is typically landscaped for aesthetic reasons and to enhance driver recognition for the roundabout upon approach. The truck apron is also considered to be a portion of the central island, but is traversable.
- Truck Aprons shall be designed such that they are traversable to trucks but discourage passenger vehicles from using them. Truck apron width shall be determined by the tracking of the **appropriate project\*** design vehicle using AutoTurn. They shall be 4 feet to 15 feet wide and have a cross slope of 1% to 2% outward away from the central island.

If the percentage of trucks anticipated to use the road exceeds 5%, that radius should be sufficient to serve those vehicles. The outer edge of the truck apron shall include a CG-3 Modified Curb (See Figure 2-15 Roundabout Truck Apron Curb Detail), to vertically separate the truck apron from circulatory roadway surface. The truck apron shall also be constructed of a different material to differentiate it from the circulatory roadway. The truck apron shall also be a different color and texture.

- Circulatory Roadway shall be sloped 2% outward away from the central island. The outward cross-slope design means drivers making through and left-turn movements must negotiate the roundabout at negative superelevation. Sloping the circulatory roadway outward away from the central island is required for the following reasons:
  - It promotes safety by raising the elevation of the central island and improves visibility,
  - It promotes lower circulating speeds due to the adverse superelevation,
  - It minimizes breaks in the cross slopes of the entrance and exit lanes, and
  - It allows surface water to drain to the outside of the roundabout.
- Curb and/ or Curb and Gutter shall be provided on the outside of the circulatory roadway and on all approaches a minimum distance equal to the length of the splitter island to help approaching drivers recognize the need to reduce their speed, prevent corner-cutting, and to confine vehicles to the intended design path.
- Inscribed Circle diameter is the distance measured across the circle inscribed by the face of the outer curb or front edge of the gutter pan of the circulatory roadway. See Figure 2-14.

---

\* Rev. 7/18

- Entry and Exit Design\*

The entry curb radius is an important factor in determining the operation of a roundabout because it affects both capacity and safety. The entry curb radius, in conjunction with the entry width, the circulatory roadway width, and the central island geometry, controls the amount of deflection imposed on a vehicle's entry path and speed. See NCHRP Report 672, Chapter 6, Section 6.4.5.

- Entry angle,  $\Phi$ , is not discussed in NCHRP Report 672, but additional information can be found in the Wisconsin Department of Transportation Facilities Development Manual, Chapter 11, Roundabouts Section 26-30.5.23. This angle is not a controlling design parameter, but instead a gauge of sight to the left and ease of entry to the right. This affects both capacity and safety at the intersection.

The exit curb radii are usually larger than the entry radii in order to minimize the likelihood of congestion and crashes at the exits. This, however, is balanced by the need to maintain slow speeds through the pedestrian crossing on exit. The exit design is also influenced by the design environment (urban vs. rural), pedestrian demand, the design vehicle, and physical constraints. See NCHRP Report 672, Chapter 6, Section 6.4.6.

- Profiles – The vertical design shall begin with the development of the approach roadway and the central island. Each profile shall be designed to the point where the approach baseline intersects with the central island. A profile for the central island is then developed that passes through these four points (in the case of a four-legged roundabout). The approach roadway profiles shall be refined as necessary to meet the central island profile. For examples see, Chapter 6 of the [NCHRP Report 672 Roundabouts: An Informational Guide, Second Edition](#). In addition to the approach and central island profiles, creating an additional profile around the inscribed circle of the roundabout and / or outer curbs are also beneficial. The combination of the central island, inscribed circle, and curb profiles allows for quick verification of cross slopes and drainage and provides additional information to contractors for staking out the roundabout.

---

\* Rev. 1/18

- Example Plan Sheets, Typical Section, Profile Sheets for a Typical Single-Lane Roundabouts can be accessed at: <http://www.virginia.gov/info/faq-roundabouts.asp> as well as in [NCHRP Report 672 Roundabouts; An Informational Guide, Second Edition](#), page 6-82.

<b>Design Element</b>	<b>Mini-Roundabout</b>	<b>Single-Lane Roundabout</b>	<b>Multi-lane Roundabout</b>
Desirable maximum entry design speed	15 to 20 mph	20 to 25 mph	25 mph to 30 mph
Maximum number of entering lanes per approach	1	1	2+
Typical inscribed circle diameter	45 to 90 ft.	90 to 180 ft.	150 to 220 ft. (two-lanes)
Central island treatment	Fully traversable	Raised (w/ traversable apron)	Raised (w/ traversable apron)
Typical daily service volumes on 4-leg roundabout below which may be expected to operate without requiring a detailed capacity analysis (veh/day)*	Up to approximately 15,000	Up to Approximately 25,000	Up to Approximately 45,000 for two-lane roundabout
*Operational analysis needed to verify upper limit for specific applications or for roundabouts with more than two lanes or four legs.			

### Roundabout Category Comparison

## BICYCLE AND PEDESTRIAN ACCOMMODATIONS

Bicycle and Pedestrian accommodations should be considered when designing roundabouts.

For pedestrians, the risk of being involved in a severe collision is lower at roundabouts than at other forms of intersections due to the slower vehicle speeds (20-30 mph). Likewise, the number of conflict points at roundabouts is also lower and thus can lower the frequency of crashes. For pedestrian design consideration, see Chapter 6 of the *NCHRP Report 672, Roundabouts: An Informational Guide, Second Edition* at [http://onlinepubs.trb.org/onlinepubs/nchrp/nchrp\\_rpt\\_672.pdf](http://onlinepubs.trb.org/onlinepubs/nchrp/nchrp_rpt_672.pdf).

For bicyclists, safety and usability of roundabouts depends upon the roundabout design. Since typical on-road bicyclists travel is between 12 and 20 mph, roundabouts that are designed to constrain vehicle speeds to similar values will minimize the relative speeds between bicyclists and motorists, and thereby improve the safety and usability for bicyclists.\*

Single-lane roundabouts are much easier for bicyclists than multi-lane roundabouts since they do not require bicyclists to change lanes to make left-turn movements or otherwise select the appropriate lane for their direction of travel.

In addition, at single-lane roundabouts, motorists are less likely to cut off bicyclists when exiting the roundabout. Therefore, it is important not to select a multi-lane roundabout over a Single-lane roundabout in the short term, even when long term traffic volumes and LOS suggest a multi-lane roundabout. However, if a multi-lane roundabout design is selected for the long term, it should be striped and signed as a single-lane roundabout initially.

For roundabout intersection spacing standards and other intersection spacing standards, see [Appendix F, Table 2-2 MINIMUM SPACING STANDARDS FOR COMMERCIAL ENTRANCES, INTERSECTIONS AND MEDIAN CROSSOVERS](#).

---

\* Rev. 7/17

## DESIGN RESOURCES

For Roundabout Consideration & Alternative Selection Guidance Tool, see Roundabouts in Virginia @ <http://www.virginia-dot.org/info/faq-roundabouts.asp>.

Additional information can be found in [NCHRP Report 672, Roundabouts: An Informational Guide, Second Edition](http://onlinepubs.trb.org/onlinepubs/nchrp/nchrp_rpt_672.pdf). See the following link:  
[http://onlinepubs.trb.org/onlinepubs/nchrp/nchrp\\_rpt\\_672.pdf](http://onlinepubs.trb.org/onlinepubs/nchrp/nchrp_rpt_672.pdf).

Additional information can also be found in VDOT's Roundabout Brochure at <http://www.virginia-dot.org/info/resources/Roundabouts.pdf> and on VDOT's roundabout web site at Roundabouts in Virginia.

## THE REVIEW AND APPROVAL PROCESS FOR ROUNDABOUTS

Existing and Proposed Subdivisions - The District Location & Design Engineer shall review and approve roundabouts in subdivisions if VDOT owns and maintains the roadway or if it is the desire of the developer / locality for VDOT to accept the roadway into the State Highway System.

Secondary System – The District shall approve roundabouts up to a traffic design volume of 10,000 VPD. Roundabout designs in which the traffic volume exceeds 10,000 VPD shall be submitted to the Innovative Intersection Committee at the preliminary field inspection, public hearing/design approval and right of way stages and for review and comments. The committee will make recommendations to the State Location and Design Engineer for approval or disapproval. Appeals of the State Location and Design Engineer's decision will go to the Chief Engineer for resolution.

When a District receives a request for a roundabout from an outside entity, and the design volume is below 10,000 VPD but requests the Innovative Intersection Committees review and comments, the submittal shall be sent to the State Location and Design Engineer. It will be reviewed and comments and/or recommendations will be returned in a timely manner.

Primary or Urban System - The District Location & Design Engineer shall submit roundabout designs to the Innovative Intersection Committee at the preliminary field inspection, public hearing/design approval and right of way stages for review and comments. The approval and appeals will be the same as mentioned above.

The process mentioned above applies to:

- Roundabouts proposed through six year construction program.
- Roundabouts proposed during road safety improvements and/or upgrades.
- Roundabouts proposed by Counties, Localities, Consultants and Developers

The plan submittal shall contain and depict the following criteria:

- Design speed & fastest theoretical path
- Design vehicle for Circulatory Roadway (S-BUS-36)
- Appropriate project\* design vehicle for Truck Apron
- Approach Grades/sight triangles/sight distances
- Inscribed outer diameter of circulatory roadway
- Apron composition, width, slope and curb standard
- Circulatory lane width
- Approach lane width/Deflection/radii
- Departure lane width/Deflection/radii
- Splitter island lengths/raised/flush
- Pedestrian crossing locations/width, composition, raised/flush, markings.
- Bicycle lane/approach & termination point.
- Pavement markings (directional arrows, yield lines, edge lines, etc.)
- Signing
- Roadway Lighting (preferred)
- Location of nearest entrances to outer inscribed diameter and nature of land use
- Present & design year volumes, % trucks & turning movements on all approaches
- AASIDRA analysis on all approaches/peak hrs. LOS/queue lengths in design year
- AUTO-TURN results of Design Vehicle for all turning movements
- Planting scheme/landscaping for mounded central island and splitter islands.
- Proximity of roundabout to nearest traffic signal.

If for some reason, the District does not have capability to run the subject computer programs, the Central Office Roundabout Review Committee can provide assistance upon request.

---

\* Rev. 7/18

## INNOVATIVE INTERCHANGE DESIGN GUIDELINES\*

### DIVERGING DIAMOND INTERCHANGE (DDI) - Also known as Double Crossover Diamond (DCD)

- An alternative to the conventional diamond interchange or other Innovative Interchange forms.
- A DDI is different from a conventional diamond interchange
  - Directional crossovers on either side of the interchange eliminate the need for left turning vehicles to cross the paths of approaching through vehicles.
- Improves the operations of turning movements to and from the freeway facility
  - Reduces the number and severity of vehicle to vehicle conflict points
- Ramp terminal intersections operate with two-phase signals for increased efficiency

## Diverging Diamond Interchange Schematic

- Overview of interchange features

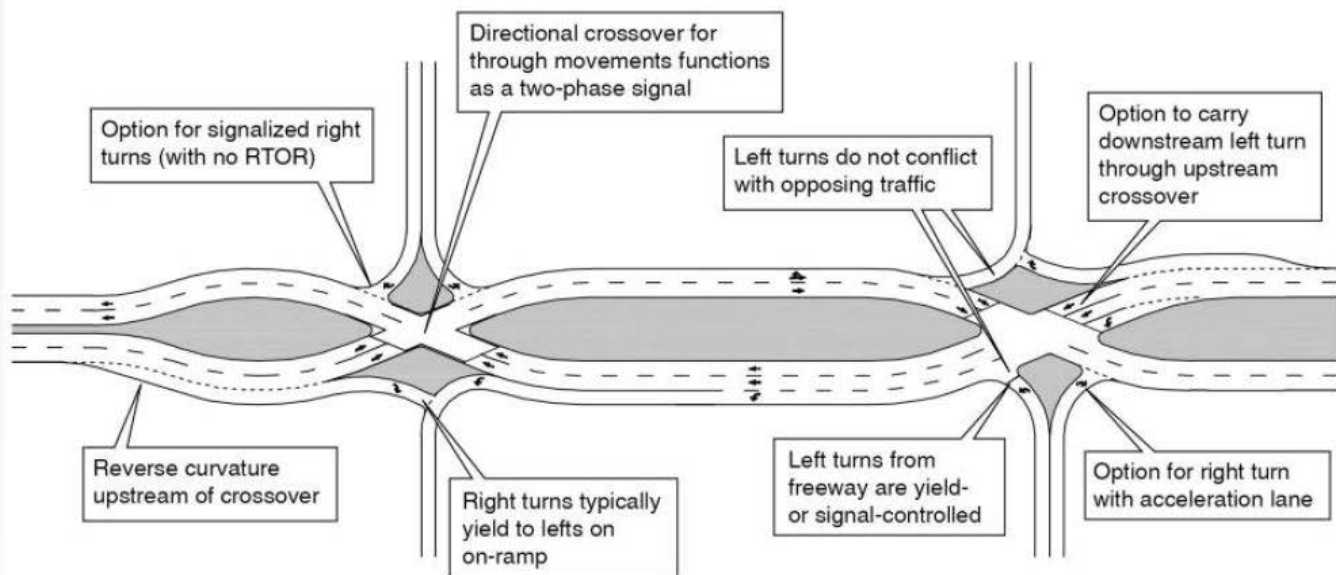

For more information on the above mentioned Innovative Intersection Designs see:  
[http://www.virginiadot.org/info/alternative\\_intersection\\_informational\\_design\\_guides.asp](http://www.virginiadot.org/info/alternative_intersection_informational_design_guides.asp)  
[https://safety.fhwa.dot.gov/intersection/alter\\_design/](https://safety.fhwa.dot.gov/intersection/alter_design/)

\* Rev. 7/17



### **Diverging Diamond Interchange (DDI)\***

A diverging diamond interchange (DDI), sometimes referred to as a double crossover diamond (DCD), is a diamond interchange that facilitates heavy left-turn movements. The upstream area consists of distance for travel during a perception-reaction time, travel for maneuvering and deceleration, and queue storage. The downstream area includes the length of road downstream from the intersection needed to reduce conflicts between through traffic and vehicles entering and exiting a property (See Figure A-3-3 for layout.) Refer to Appendix F, Figure 4-2A for Physical and Functional Areas of Intersection and Figure 4-3 to determine Functional Area of Intersection along the minor roadway. The Access Management Manual published by the Transportation Research Board notes that “Stopping sight distance is one method of establishing the downstream functional areas of an intersection.” When calculating downstream functional area with this method, traffic control at the intersection is not a factor.

While the ramp configuration is similar to a traditional diamond interchange, traffic on the cross route moves to the left side of the roadway for the segment between signalized ramp intersections. By moving traffic to the left, left-turning vehicles can enter from the ramp to the major roadway without the need for a left-turn signal phase at the signalized ramp intersections. In addition, a DDI reduces conflict points of a traditional diamond interchange from 30 to 18 based on fewer crossing points. (See Table 3-1). This includes merge and diverge points on the major road, not at the ramp terminals.

This reduction in conflict points should represent significant improvement in safety.

Some of the situations where a DDI may be suitable are listed as follows:

- Heavy left turns from ramps onto major roadway
- Moderate or unbalanced through volumes on the crossroad approaches
- Moderate to very heavy left-turn volumes from the major roadway off-ramps
- Limited bridge deck width
- Expected remaining life of the bridge should be evaluated when considering the DDI design when the project involves converting an existing diamond interchange to a DDI without widening the existing bridges.

<b>TYPE</b>	<b>Diamond</b>	<b>SPUI</b>	<b>DDI</b>
Diverging	10	8	8
Merging	10	8	8
Crossing	10	8	2
<b>Total</b>	<b>30</b>	<b>24</b>	<b>18</b>

**TABLE 3-1 CONFLICT POINTS**

---

\* Rev.7/17

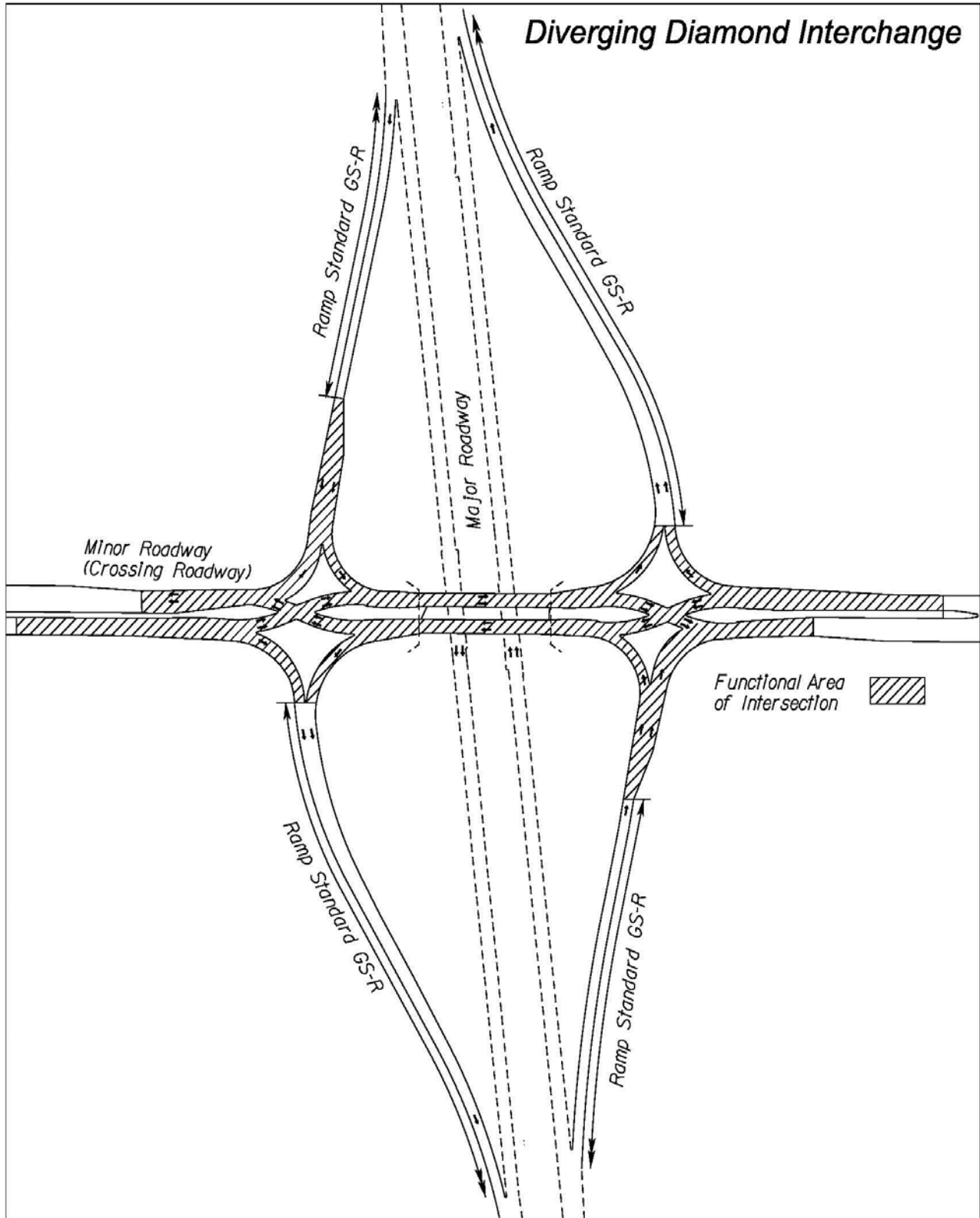

**FIGURE A-3-3 DIVERGING DIAMOND LAYOUT\***

\* Rev. 7/17

**Advantages of This Type of Interchange\***

- The DDI interchange offers benefits over conventional interchange designs with its efficient two-phase signal operation, narrower bridge structure width, lower costs, fewer conflict points, expected increase in throughput, reduced vehicular delay, opportunities for reducing pedestrian / vehicle conflicts and reduced environmental impact.
- A DDI has a higher capacity for all signalized movements when compared to the conventional diamond interchange. The capacity of left-turn movements is approximately twice that of the corresponding capacity of left-turn movements of the conventional diamond interchange. Exclusive left-turn lanes on the cross route are not necessary for the DDI. The ability to accommodate a high number of left turns improves the efficiency and, thereby, the capacity of the interchange.
- To be comparable to a 4-lane DDI, a conventional diamond interchange would require 6 lanes to provide the same capacity. When additional future capacity is needed, it could be advantageous to convert a conventional diamond interchange to a DDI instead of pursuing the more costly option of widening the major and minor roadways in the interchange (including widening the bridge) and adding additional lanes to the ramps. Any conversions and capacity/efficiency benefit however should be analyzed using the appropriate traffic analysis tools.
- The application of a DDI may reduce project costs by allowing the use of existing structures and right of way or, at least, requiring the narrowest or shortest bridge and right of way template possible. This is mainly due to the reduction of required left-turn lanes. Under appropriate traffic conditions, there may be a possibility that designated left-turn lanes can be eliminated in one or both directions on the cross route. The appropriate lane geometry of a DDI should be however analyzed and modeled ahead for traffic operational behavior.
- The DDI's advantage is to make the movement from the cross route to the major roadway more efficient. The left turn from the cross-ramp onto the on-ramp should not be signalized unless necessary to address the potential for pedestrian conflicts.

---

\* Rev. 7/17

## Disadvantages of This Type of Interchange

While the advantages of the DDI make it an attractive solution for a variety of traffic conditions, it is not applicable everywhere. As with any solution, there are disadvantages to consider.

- When current or projected cross route through volumes are high, the drivers inconvenienced the most by the installation of a DDI are those going through on the cross route because they must crossover to the left side of the road and then back again to reach their destination.
- Problematic for high-speed arterials. Reverse curves of crossovers based on 35 mph or slower.
- Through movements must be controlled and cannot be free-flow. If current or projected through traffic volumes on the crossing route are high, other interchange configurations should be considered at the conceptual stage.
- Off-ramp traffic may not directly re-enter an on-ramp. However this design does allow for U-turns from one direction of the major route to the other.
- In areas with HOV lanes located in the median, future HOV connections to the overpass structure may not be feasible with a DDI configuration.
- If there is a high volume of pedestrians, additional signals may be needed and must be timed for adequate pedestrian crossing times, thus, potentially influencing the effectiveness of the interchange.
- Geometry and traffic control device design must be very carefully thought out to minimize any possibility of drivers and/or bicyclists entering the wrong direction between the crossovers. More overhead sign structures with larger guide signs may be needed at a DDI as compared to a traditional diamond interchange
- There are no U-turns at the intersections of a DDI at the ramp.
- Closely spaced intersections to the DDI could heavily influence traffic demand to/from the DDI, potentially limiting the operational effectiveness of the DDI for vehicular traffic
- Generally, a DDI is limited to one of two operational strategies: emphasized coordination to the off-ramp left turn movement or emphasized coordination of the through traffic movement across the interchange. If both movements are heavy, the overlap of queues can be difficult to overcome during peak periods without sufficient capacity.
- Future traffic growth should be figured into the design including the modification for additional capacity.\*

---

\* Rev. 7/17

## **Crossovers (See Figures A-3-4 & A-3-5) \***

The horizontal crossover geometrics consist of three main interacting elements: 1) crossing angle; 2) tangent length approaching and following the crossover; and 3) superelevation and curve radii approaching and following the crossover. Placement of the two crossovers is largely dependent upon the spacing and location of the ramps. The space needed for vehicular storage between the crossovers must also be considered. When there is room, there is a fair degree of flexibility in the placement of the crossovers. If more length is needed than the distance between ramp termini provides, the crossovers may be located farther apart. As a result, the ramp entrances and exits will need to be configured to merge or diverge with the cross route by either extending or shortening them. For practical design application, the center of each crossover can be slightly skewed from the crossroad centerline and/or offset, as shown in Figure A-3-4.

### **Crossing Angle**

The crossing angle is the acute angle between lanes of opposing traffic within the crossover with optimum crossing angles ranging from 40-50°. The approach angle for cross-over intersections of a DDI should be 30° or greater. A recommended approach is to use the largest crossing angle possible while balancing each of the horizontal geometric crossover aspects. However care should be exercised in choosing a larger crossing angle, which could cause drivers to perceive it as a “normal” intersection.

Larger crossing angles in combination with sharper reverse curves can increase potential for overturning and excessive driver discomfort due to centrifugal forces acting on the driver. Cargo may also shift back and forth depending on speed. Another crossing angle factor that compounds driver discomfort is when the length of roadway between crossovers and/or approaching crossovers is limited. The appropriate geometry of a DDI should be analyzed and modeled ahead for traffic operational behavior

### **Superelevation Design / Curve Radii**

The curves approaching and following the crossover should allow the design vehicle to navigate the interchange at the design speed as well as accommodate the turning movements to and from the ramps. In most instances, an urban low speed design ( $\leq 45$  mph) should be used on the roadway containing the DDI and adhere to VDOT's TC-5.11ULS superelevation criteria. The design vehicle, a WB-67 as shown in 2011 AASHTO Green book Figure 2-15, should be able to operate through the DDI at 20 mph and make all turning movements to and from the ramps. A vehicle classification count should be done to determine the vehicle composition in the area and AutoTurn should be used to make sure the angles proposed are negotiable by the most restrictive vehicle. In addition, the urban low speed design should encompass the footprint (See RDM [Appendix F, Figures 4-2A and 4-3](#)) of the intersecting ramps.

---

\* Rev. 7/17

The remaining entrance ramp and exit ramp design (Standard GS-R) should continue with VDOT's TC-5.11 rural superelevation between the major roadway and the functional area limits of the minor crossroad (See Figure A-3-3).\*

Urban design criteria shall be used within the DDI. For entrance ramps to the major roadway, the urban designation ends at the gore area (See Figure A-3-3).

Each curve along the minor roadway should transition to and from the tangents of the crossover. Curve radii used along the crossroad in DDI designs generally range from 150-400 feet depending on chosen design speed.

### **Tangent Length**

The most valuable aspect of adding tangent length before and after a crossover is the propensity to align vehicles to the correct receiving lane as they approach the crossover.

When tangent length beyond the intersection is used, a length of 15-20 feet along the inner edge of pavement is recommended before the crossover. This distance should be provided measuring from behind the stop bar when possible, but may be provided from the crossover itself when space is limited. Since cars do not experience stopping after the crossover, a shorter length of about 10-15 feet along the inner edge of pavement is encouraged. Figure A-3-4 shows the recommended minimum lengths.

### **Lane Width**

The crossover lane width is a function of the layout and horizontal geometrics in conjunction with modeling the off tracking of a WB-67. A recommended approach is to begin the design using the minimum lane widths of 15 feet and widen them based on the off-tracking modeling until optimum lane width is achieved. Such might be the case if the crossroad has a wide median. All approach lanes on the crossroad should be tapered following the lane width transition as shown in Figure 3-23 in Appendix F of the RDM. The lanes should be tapered to meet the crossover lane width before entering the curve approaching the crossover and maintained through the curve after the crossover. Between the crossovers, lane widths may need to be tapered if existing conditions constrain the roadway. Existing structures can limit lane width between crossovers. Right-of-way can affect lane width approaching a crossover.

Pedestrian and bicycle accommodation can influence lane widths before, after and between the crossovers. The ramp spacing and distance between the crossovers are additional considerations. The lane width between the crossovers should meet standard lane width where possible but shall not exceed the lane width of the crossover.

---

\* Rev. 7/17

## Shoulders\*

If the cross route has shoulders and there is space, they should be continued through the interchange. For a relatively short segment in a DDI, the left shoulder becomes the outside shoulder and the right shoulder becomes the inside shoulder. For this reason, some alterations to the shoulders may need to be considered.

Under normal circumstances, when a vehicle needs to pull over and stop, the driver expectation is to use the right shoulder. In addition, the left lanes between the crossovers will be heavily used for left-turn movements and potentially experience more weaving. While it is not desirable to have vehicles stop and pull over between the crossovers, the design should account for that possibility when feasible. The right shoulder is considered the safer place, which, in this case, is the inside shoulder. In addition, bicyclists riding on the right shoulder would expect to be able to continue using the same shoulder through the interchange.

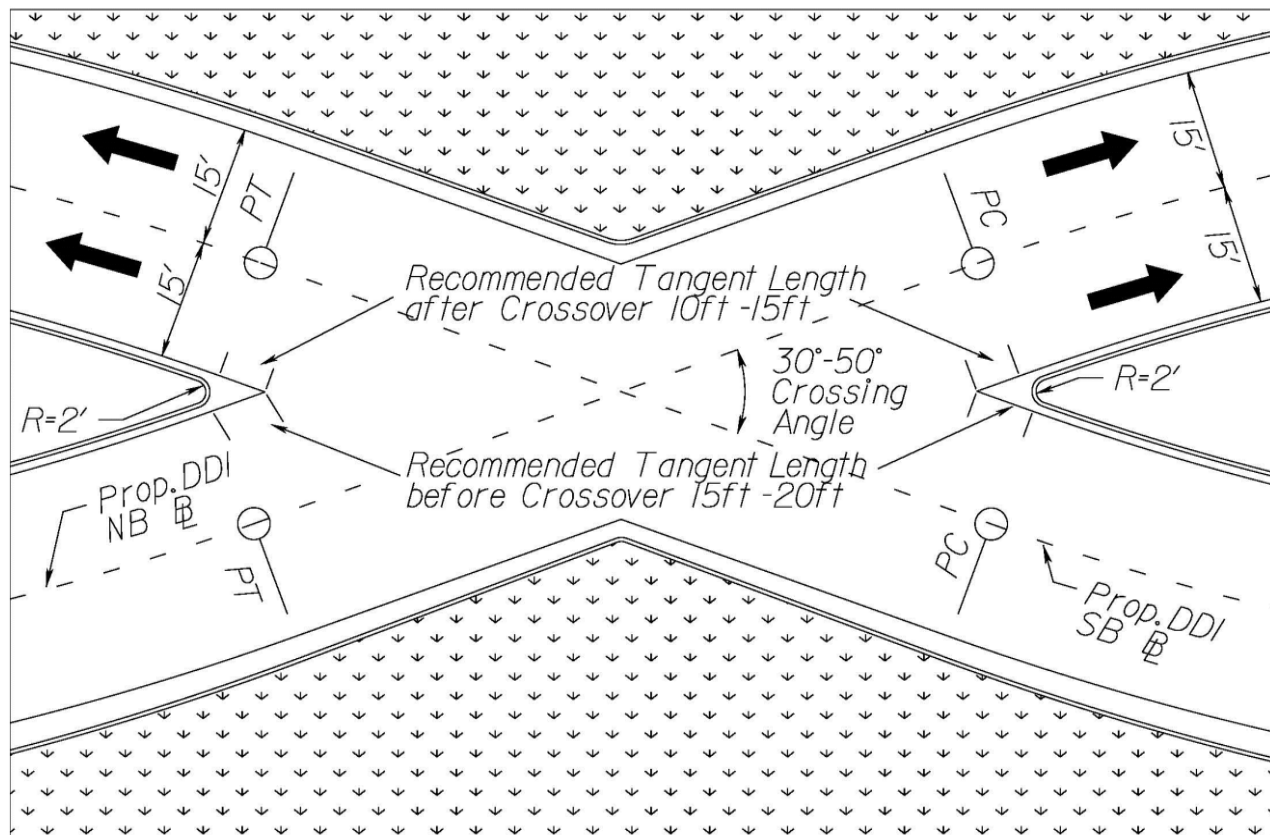

**FIGURE A-3-4 CROSSOVER GEOMETRICS**

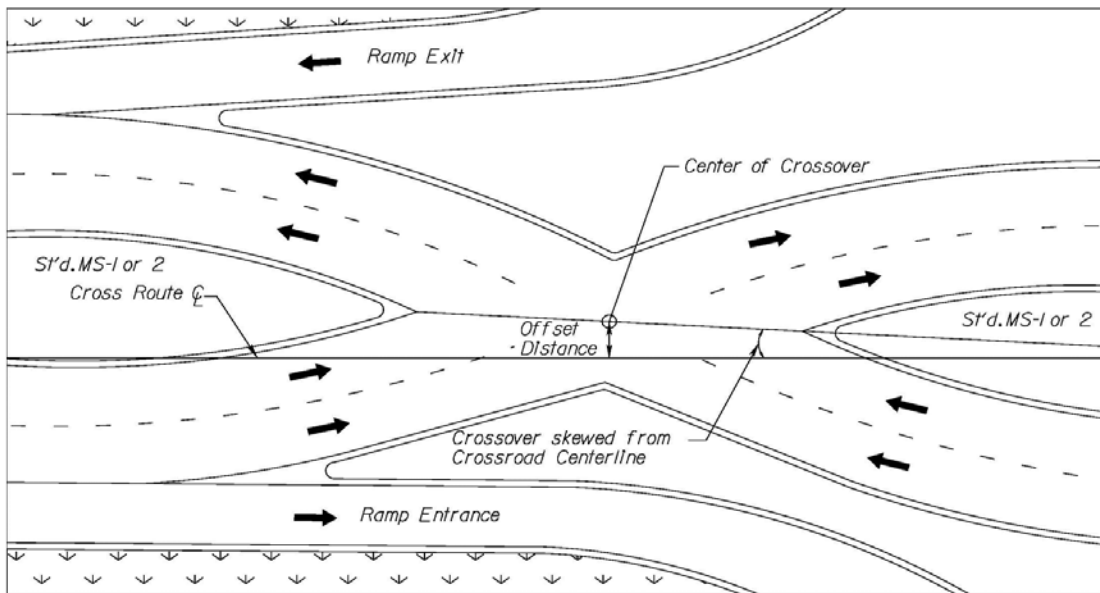

**FIGURE A-3-5 OFFSET DISTANCE FOR INTERSECTION**

Current design practices that had shoulders on the cross route kept the right and the left shoulder widths constant through the interchange, as shown in Figure A-3-6. However, it may be advantageous to narrow the left shoulder approaching and between the crossovers to discourage drivers from stopping. Cross routes passing over the major roadway on existing structures may require both shoulders to be narrowed similarly to a traditional diamond interchange.\*

Shoulder design requires more right of way or more bridge span length when the crossing roadway is under the bridge. Shoulders may not be feasible for a DDI located under a bridge.

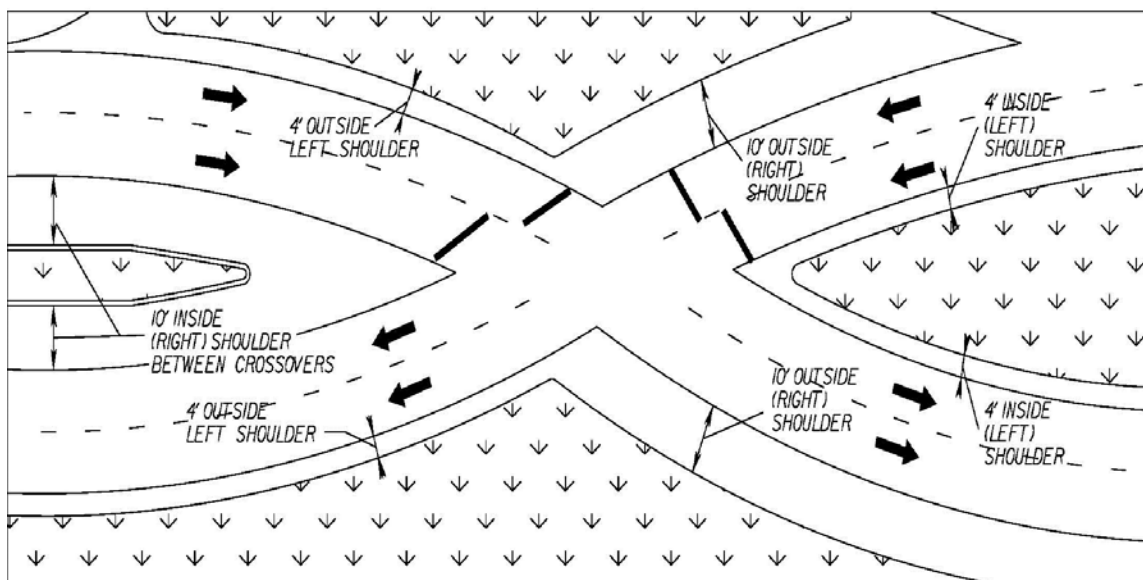

**FIGURE A-3-6 SHOULDER DESIGN FOR DDI**

\* Rev. 7/17



**Sight Distance**\*

Two areas of specific importance to a DDI are sight distance for vehicles making crossover movements and vehicles exiting from the major roadway. The driver of a vehicle approaching or departing from an intersection should have an unobstructed view of the intersection, including any traffic control devices, and sufficient length along the cross route to permit the driver to anticipate and avoid potential collisions. The same sight distance principles, as described in the AASHTO Green Book, should be followed when designing a DDI.

Particular attention should be paid to the sight lines of vehicles turning from an exit ramp under yield control; this is true for either single- or multiple-turn lanes. For the driver making a right turn from the exit ramp of a DDI, their expectation is that traffic will be moving from the nearest lanes on their left. However, the traffic is actually approaching from the far left lanes since the direction of traffic is switched, as shown in Figure A-3-7.

If there is room, a possible way to minimize this issue is by moving the right turn further from the crossover to increase the amount of sight distance available to these right-turners as well as give them more time to realize where oncoming traffic is coming from. The approach angle should be such that drivers in the turning lane should be able to see the oncoming traffic without difficulty for yield control condition.

For a signal controlled condition, sight triangles between the left turns and right turns to and from the ramps should not be large. This means the island between the left and right turn lanes from the ramp should be designed accordingly. Smaller sight triangles will also shorten all the red times to clear traffic leaving the crossover intersections and also clear the next conflict point.

Another consideration is to channelize the right turn coming off the ramp more so when drivers turn to view the oncoming traffic, it more likely falls in their natural line of sight. The right turn lanes could be extended so that traffic is parallel and vehicles can merge further from the crossover.

---

\* Rev. 7/17

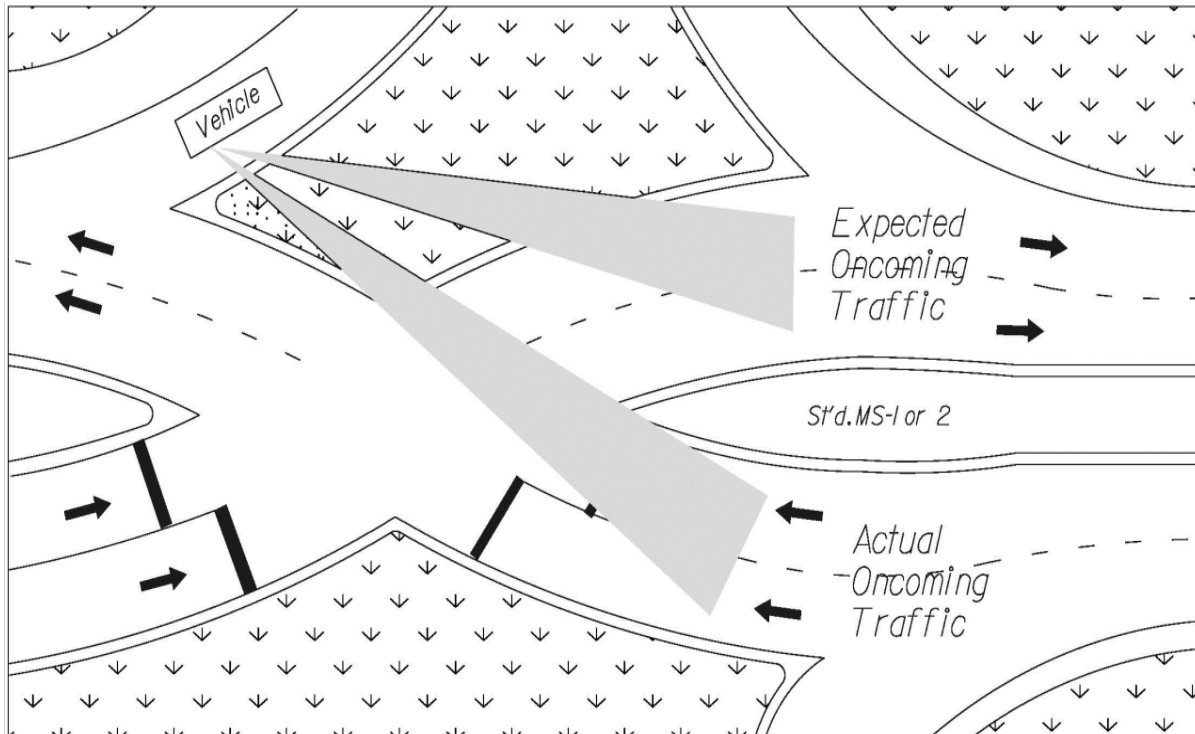

**FIGURE A-3-7 DIAGRAM OF EXPECTED ONCOMING TRAFFIC VERSUS ACTUAL ONCOMING TRAFFIC**

### **Clear Zones\***

Clear zones are to be provided on all ramps and the minor roadway. See RDM Appendix A, Section A-2 for more guidance on clear zone.

### **Lateral Offset**

The minimum lateral offset of 1.5 feet is to be provided on the minor roadway when using curb and gutter design. See RDM Appendix A, Section A-2 for more guidance on lateral offset.

### **Ramps**

Traffic capacities for ramp design are subject to variation and are limited by the geometric features of the ramp itself, the ramp termini, the weaving sections, the volume of through and turning traffic and intersection spacing within the functional area of the interchange. Because the ramp through-movement is physically prohibited, accommodations for this movement downstream of the interchange on the cross route should be considered. These accommodations should be considered when applying access management principles and evaluating capacity.

\* Rev. 7/17

Traffic operational analysis of the existing conditions at the interchange, as well as for the proposed DDI shall be performed to determine the appropriate DDI geometry and quantify the operational benefit in terms of delay (sec), queue lengths (feet), etc. The analyses shall be conducted for the existing traffic volumes for existing geometric conditions and DDI, and projected future traffic for existing geometric conditions and DDI, the projected year of analysis shall be discussed and determined with the VDOT project manager, it shall include any major change in traffic volume patterns anticipated due to land use, etc., this is necessary as the efficiency of a DDI is dependent on the traffic volume patterns.\*

The analyses shall be based on the guidelines in VDOT's latest version of the Traffic Operations Analysis Tools Guidebook and in consultation with the VDOT project manager/traffic engineer within a mutually agreed upon impact area. The traffic impact area shall contain at a minimum, the interchange being considered including the full length of all ramps proposed and the merging area of the on-ramp with the interchange/ main roadway; and any median accesses within ½ mile on either direction of the cross road. The traffic analysis shall at a minimum include all the proposed signal coordination plans within impact area, the controller configurations (single/multiple) and also include left turn on red analysis. In addition, engineering judgment should be used to determine the various aspects of the geometry and signal configuration proposed; all suggested geometry and signal configurations shall be evaluated as described above.

Ramp design for a DDI should take into consideration the need of separate lanes for left-and right-turning traffic especially when either movement is signalized. While traditional ramp designs allow for shared lane usage, exit ramp design for a DDI should provide separate left- and right-turn lanes prior to the ramp terminal. This is because the phasing for the signalized left turn and right turn typically does not occur simultaneously. The storage lengths of these lanes are dependent upon projected volumes and potential queuing.

### **Access Control / Spacing of Intersections**

Nearby signalized intersections may reduce the effectiveness of a DDI. The two-phased signal phasing of the DDI typically allows for shorter cycles lengths which may impact the coordinated operations of nearby traffic signals. When evaluating a DDI, the traffic analysis should consider whether the entire interchange should be operated with a single signal controller or if multiple controllers should be used for the two separate intersections.

As with any interchange type, the minimum intersection spacing shown in the RDM [Appendix F, Table 2-3](#) and [Figure 2-9](#) shall be used. VDOT's access control standards shall be followed. However in developed areas, it may be difficult to achieve the standards. If these standards are not met, an Access Management Exception (AM-E) or an Access Management Waiver (AM-W) shall be required.

---

\* Rev. 7/17

Special consideration must be given in evaluating a DDI when the nearest full access intersection is less than the minimum distance shown in Appendix F. The DDI typically operates essentially as a two-phase signal with only one direction of travel on the cross route allowed through the interchange at a time. When there is a signalized intersection in close proximity to the DDI, it may not be possible to coordinate both directions of travel along the cross route with the adjacent signal resulting in one direction of travel queuing in the small space between the intersections. When considering a DDI with a signalized intersection close to the interchange functional area, other interchange types should also be considered.\*

Traffic projections require additional attention when evaluating the use of a DDI in a closely spaced signal system. When this is the case, a sensitivity analysis should be performed. A sensitivity analysis evaluates how changes in the traffic projections affect the results of the operational analysis (LOS or capacity). The sensitivity analysis will show if the proposed improvements only work under a limited number of traffic conditions or if the proposed improvements are flexible enough to satisfy a variety of future traffic conditions.

At this time, it does not appear that closely spaced right-in, right-out access or left-in accesses pose a greater challenge for DDIs compared to other interchange types. When evaluating non-signalized access points, additional care should be given so the access does not interfere with the operations of the right turns either onto or off the ramps. Spacing between the two crossover intersections should be sufficient enough to accommodate the through queue for the design year. As a rule of thumb, spacing between the crossovers should be a minimum of 800 feet. Maximum queues based on microsimulation modeling should be used to verify the spacing between two crossover intersections.

## **Pedestrians**

There are two basic ways to accommodate pedestrians at a DDI. They can be placed in the middle of the cross route between the crossovers (Figure A-3-8) or kept on the outside perimeter (Figure A-3-9). This decision can influence the number of signals and the capacity of the interchange. If pedestrians are kept to the outside perimeter as shown in Figure A-3-9, then they do not have the ability to cross from one side of the street to the other.

Pedestrian crossings for a DDI may involve crosswalks and signal pedestrian control features at the junctions of the interchange. Depending on the pedestrian network in the vicinity of the interchange, it may not be necessary to have pedestrian walkways on both sides. Since the crossover junctions in a DDI operate on a two-phase signal control, pedestrians are directed to cross the minor roadway in two stages. Adequate pedestrian refuge should be provided between all stages of the crossing. Depending on the configuration, pedestrians may have higher or lower numbers of controlled and uncontrolled crossing locations at a DDI as compared to a traditional diamond interchange.

---

\* Rev. 7/17

Any pedestrian crossings of free-flow movements should be carefully reviewed to ensure adequate sight distance for drivers approaching the crosswalk. In the case of a DDI where the cross route passes underneath the major road, the structure may also impact sight distance.\*

The DDI design involves multiple-stage crossings with islands acting as refuges. In addition, the design of crossovers at the nodes of the interchange typically results in flares and large central islands. Barriers help prevent pedestrians from attempting to cross at undesirable locations. Barriers should be rigid with appropriate end treatment. Alternatively, guardrail systems that pose a lesser hazard to motorists (i.e., spearing hazard) can be used to channelize pedestrians. Barrier separation from traffic should be used when pedestrians are placed down the center of the cross route. If bicycles will be present, a barrier height of 54 inches is required. Minimum standard sight distance shall be provided when barrier is present.

All sidewalks and crosswalks shall be in compliance with VDOT standards. (See [IIM-LD-55](#) and RDM Appendix A)

Pedestrian facilities located along the outside of the interchange may also cause pedestrians to make more conflicting movements, walk a longer distance, and cross at an unsignalized left-turn. Most pedestrians are not accustomed to crossing at the unsignalized left-turn of a DDI.

When pedestrian facilities are present, the left or right turn to and from the ramps may require signalization and negatively influence the interchange's operation. The negative impact may be minimized depending upon geometrics and other design choices. Some at-grade pedestrian crossings can be located where oncoming traffic approaches from an unfamiliar direction. Since pedestrians are typically conditioned to look "left-right-left" before crossing the street, there is potential for pedestrian confusion at these locations.

When the crossroad passes under the limited access highway, structural obstacles may restrict sight distance at free left turns approaching pedestrian crossings.

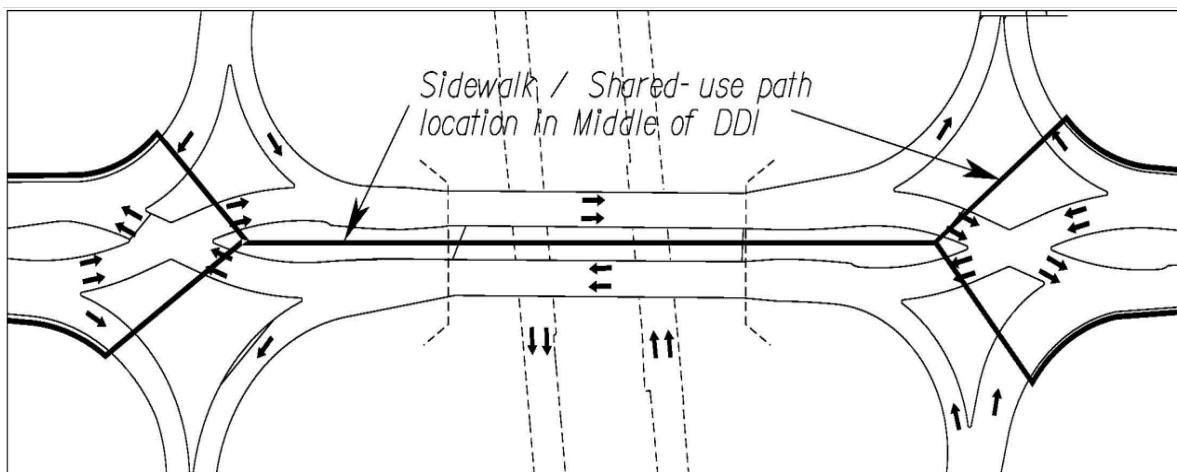

**FIGURE A-3-8 PEDESTRIANS LOCATED TO MIDDLE OF CROSSROAD BETWEEN CROSSOVER**

\* Rev. 7/17

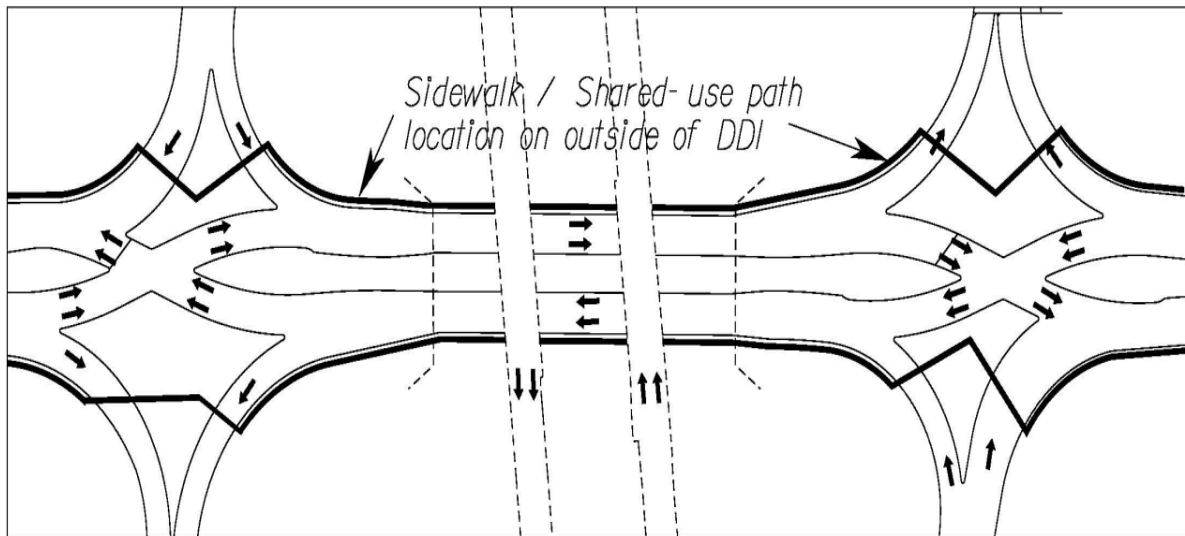

**FIGURE A-3-9 PEDESTRIANS LOCATED TO OUTSIDE**

### **Bicycles\***

Bicycle accommodations should be considered on all DDI designs and, whenever possible, existing bike accommodations should continue through the interchange. Bicycles operating along the minor roadway through a DDI can be accommodated with the use of bicycle lanes or shared-use paths. If bike lanes or shoulders cannot be carried through the interchange due to space constraints, they should be terminated far enough in advance to encourage cyclists to mix with vehicle traffic. Bicycles are encouraged to stay in the right side of the right lane through a DDI. If a high volume of bicyclists is expected and a sidewalk is proposed, it should be widened and constructed using Shared Use Path design criteria as shown in RDM Appendix A and as given in AASHTO's *"Guide for the Development of Bicycle Facilities."* If bicycle lanes are carried through the interchange, bicyclists should be directed to stay to the right of traffic (on the inside) between the crossovers. Careful consideration needs to be given to the potential for bicycle-vehicle conflict and also to provide proper guidance for bicyclists so they do not attempt to ride on the wrong side between the crossovers.

### **Standards and Criteria**

- Urban Low Speed criteria shall be followed along minor roadway of the DDI. A Design Exception is not required for Design Speed within the functional area of a DDI that does not meet the corridor design speed. (See Figure A-3-3)
- Left-turn and through movements are relocated to the opposite side of the road on the bridge structure.
- The minimum spacing between crossovers should be 800 ft.
- The crossing angle of intersection should be between 30° and 50° (See Figure A-3-4).

\* Rev. 7/17

- The minimum design speed for the minor roadway shall be 25 mph.
- The minimum design speed where the ramps meet the crossroad shall be 25 mph (every attempt is to be made to use a design speed greater than minimum).\*
- Turning radii used at the crossover junction are typically in the 150 to 400 ft range and shall be determined by design vehicle.
- Curb and gutter design is preferred along the crossing roadway.
- The appropriate GS standard shall be used based on the functional classification of the crossing roadway.
- Standard MS-1 is preferred along the cross road due to less maintenance requirements.
- Lane width through the crossover shall be a minimum of 15 ft.
- Design shall accommodate WB-67 trucks so that one truck in each lane of the design can make the required movements without encroaching into the adjacent lane (if there is one). Autoturn® should be run to determine the off-tracking of the design vehicles and lane width should be adjusted upward to accommodate. Please see 2011 AASHTO Green book Tables 3-26b and 3-27.
- For channelization and safety reasons, a physical barrier should be provided between the crossovers to separate opposing directions of traffic. Either a barrier or a raised median shall be designed to physically separate opposing traffic between the crossovers.
- Adequate lighting should be provided. VDOT requires all roadway lighting designs to meet the lighting criteria as discussed in the current IESNA publication, *Recommended Practices for Roadway Lighting (RP-8)*. See [VDOT's Traffic Engineering Design Manual](#), Chapter 2 for more information.
- DDI interchange designs may only be appropriate where there are high-turning volumes.
- Median width is increased to allow for the flaring required for reverse curves on the interchange approaches.
- The noses of the median island should extend beyond the off-ramp terminals to improve channelization and prevent erroneous maneuvers.
- Median openings may be placed upstream of the interchange to allow U-turn movements on the minor roadway. There will be no U-turns allowed within the DDI functional area.
- Left- and right-turn lanes should not be shared and should be designed assuming that they will run under separate signal phases.

---

\* Rev. 7/17

## **Traffic Signal Considerations\***

A DDI interchange typically has two signalized junctions or nodes at the points of left-turn crossovers. The signals operate with just two phases, with each phase dedicated to the alternative opposing movements.

While every movement within a DDI can be signalized, they are not necessarily required to be. Turning movements should be signalized after considering factors such as the volume of conflicting pedestrians, the nature of the lane merge (yield or free-flow), the volume of the turning movements as well as the through traffic on being processed through the crossovers, and the number of turning lanes. Signalization of all movements should be considered on a case-by-case basis.

Signal warrant analysis and the need for pedestrian control features for the DDI shall follow the guidelines provided in the [MUTCD](#), the Virginia Supplement to the [MUTCD](#), and engineering judgment.

When signalizing the off-ramp left-turn, the distance between the crossover intersection and the off-ramp left-turn should be minimized. The longer the distance for the through movement to clear the intersection the longer the duration of the all-red clearance interval. Increase in the clearance interval may reduce the effective green time for the signal and the efficiency of the signal. The need for the long red clearance interval may not be readily apparent to many drivers and public expectations may need to be addressed.

Since left turning movements do not conflict with the opposing through movement in the DDI, left turn on red can be considered from the ramp. Due to the unique curvature and geometry of a DDI, special attention should be given to signal face placement. The primary consideration in the placement of signal faces is to optimize the visibility of signal indications to approaching traffic. Road users approaching the intersections are to be given a clear and unmistakable indication of their right-of-way assignment. All signal face placement, aiming, adjustment and positioning shall be in accordance with the [MUTCD](#) and/or [Virginia Supplement to the MUTCD](#).

Special attention should also be given to signal structure/mast arm and luminaire placement to ensure structures do not block the view of other traffic control devices. Straight-through green arrow signals, may be appropriate to discourage wrong-way turns, however the [MUTCD](#) expressly prohibits use of upward yellow arrow and upward red arrow signal indications.

Supplemental near-side traffic signal indications may be appropriate to provide optimal visibility for the movement to be controlled. It may also be appropriate to consider signal visors, signal louvers, or other means to minimize an approaching road user's view of signal indications controlling movements on other approaches.

Refer to Chapter 4D of the [MUTCD](#) and/or [Virginia Supplement to the MUTCD](#).

Consideration should be made for yield control vs. signal control for the DDI off-ramp left turns. One advantage to signalizing the DDI off-ramp left turn movement is it removes the weaving between those drivers and drivers on the cross street intending to turn left onto the downstream on-ramp.

---

\* Rev. 7/17



## Signing and Pavement Markings\*

Signing and pavement marking for the DDI shall follow the [MUTCD](#) and the Virginia Supplement to the [MUTCD](#). Since the DDI is a newer design, placement of markings, wrong-way signs, approach signing, overhead approach signage and wrong-way arrows/directional arrows to emphasize the correct direction of travel is critical. In addition, advance guide signs for drivers to stay in appropriate lane are equally important. Consideration should also be given to minimizing the amount of “sign clutter” that could cause driver delay or confusion.

Stop bars, yield bars and arrow lane markings are all standard applications. Dotted lane-line extensions are typically used to help guide motorists through the crossovers.

The potential for wrong way traffic movements in a DDI can be minimized with geometrics, signing, pavement marking, signals and lighting.

Although a DDI’s geometrics requires traffic on the cross route to move the left side of the roadway for the segment between signalized ramp intersections, the pavement marking used is similar to other interchanges. The yellow stripe shall be used on left of traffic and white on the right between crossovers.

6” wide lane and edgelines should be used through the DDI to improve driver recognition. Wider markings may be transitioned to normal markings downstream of the DDI at logical termini.

Snow-plowable reflective pavement markers (with red reflectors for the wrong-way movement) should be considered for use within the DDI for lane lines, wrong-way arrows and where appropriate on edge lines. Structure & Bridge Division approval may be required prior to installing raised pavement markers on bridge decks.

Guide signing is essential to proper operation of the DDI. Given the complex nature of the interchange, consideration should be given to mounting the guide signs for the cross street on overhead (butterfly, cantilever, or full-span) structures to safely guide drivers through the interchange and minimize the potential for confusion that results in drivers entering the wrong side of the DDI. If cantilever and/or full-span sign structures are used, they shall not exceed the maximum span lengths specified in the current version of [IIM-S&B-89](#).

Raised reflective markers should not be used on or adjacent to edgelines in areas where bicycles might be expected to exit or enter the shoulder across the edgeline.

Additional regulatory and warning signage may be necessary to guide users through the DDI. Examples of signs that should be considered are R4-8 series “Keep Left” signs and W24-1L series reverse curve warning signs. However excessive signing should be avoided to avoid distracting drivers with a “forest of signs” effect.

---

\* Rev.7/17

**\*Resources:**

1. FHWA DDI Informational Guide  
[http://www.virginiadot.org/FHWA-SA-14-067\\_DDI\\_Informational\\_Guide.pdf](http://www.virginiadot.org/FHWA-SA-14-067_DDI_Informational_Guide.pdf)  
FHWA DDI Brochure  
[http://www.virginiadot.org/FHWA-SA-14-039\\_DDI\\_Informational\\_Brochure.pdf](http://www.virginiadot.org/FHWA-SA-14-039_DDI_Informational_Brochure.pdf)
2. “Engineering Policy Guide, Chapter 234.6: Diverging Diamond Interchanges”, Missouri Department of Transportation 2014. Online:  
[http://epg.modot.org/index.php?title=Main\\_Page](http://epg.modot.org/index.php?title=Main_Page)
3. “Tech Brief: Double Crossover Diamond Interchange.” Federal Highway Administration. 2009. Online:  
<http://www.fhwa.dot.gov/publications/research/safety/09054/09054.pdf>
4. “Tech Brief: Drivers’ Evaluation of the Diverging Diamond Interchange.” Federal Highway Administration 2008. Online:  
<http://www.tfrc.gov/safety/pubs/07048/07048.pdf>
5. “Innovative Diamond Interchange Designs: How to Increase Capacity and Minimize Cost.” David Stanek. Institute of Transportation Engineers. 2007. Online:  
<http://tinyurl.com/y9yum2o>
6. “Traffic and Operational Comparison of Single-Point and Diverging Diamond Interchanges.” Praveen K. Edara. Transportation Research Board. 2009.
7. “Alternative Intersections/Interchanges: Informational Report”, Federal Highway Administration, 2010. Online:  
<http://www.fhwa.dot.gov/publications/research/safety/09060/>

### **SINGLE POINT URBAN INTERCHANGE (SPUI)\***

The SPUI, another variant of the compressed diamond interchange, was developed in 1970 to improve traffic capacity and operations while requiring less right-of-way than the diamond interchange. The turning movements of the major road ramps and all the movements of the minor road are executed in one central area that is either on the overpass or underpass.

Some of the key design characteristics that need to be considered when designing a SPUI are skew angle; number of through, left-, and right-turn lanes; median width; and islands. Generally, the bridge of a SPUI has a span length from 160 to 280 ft. depending on various geometrics of the crossing. The bridge structure of a SPUI has a large deck and is more expensive to construct in comparison to a TUDI, which is relatively easy to design and construct.

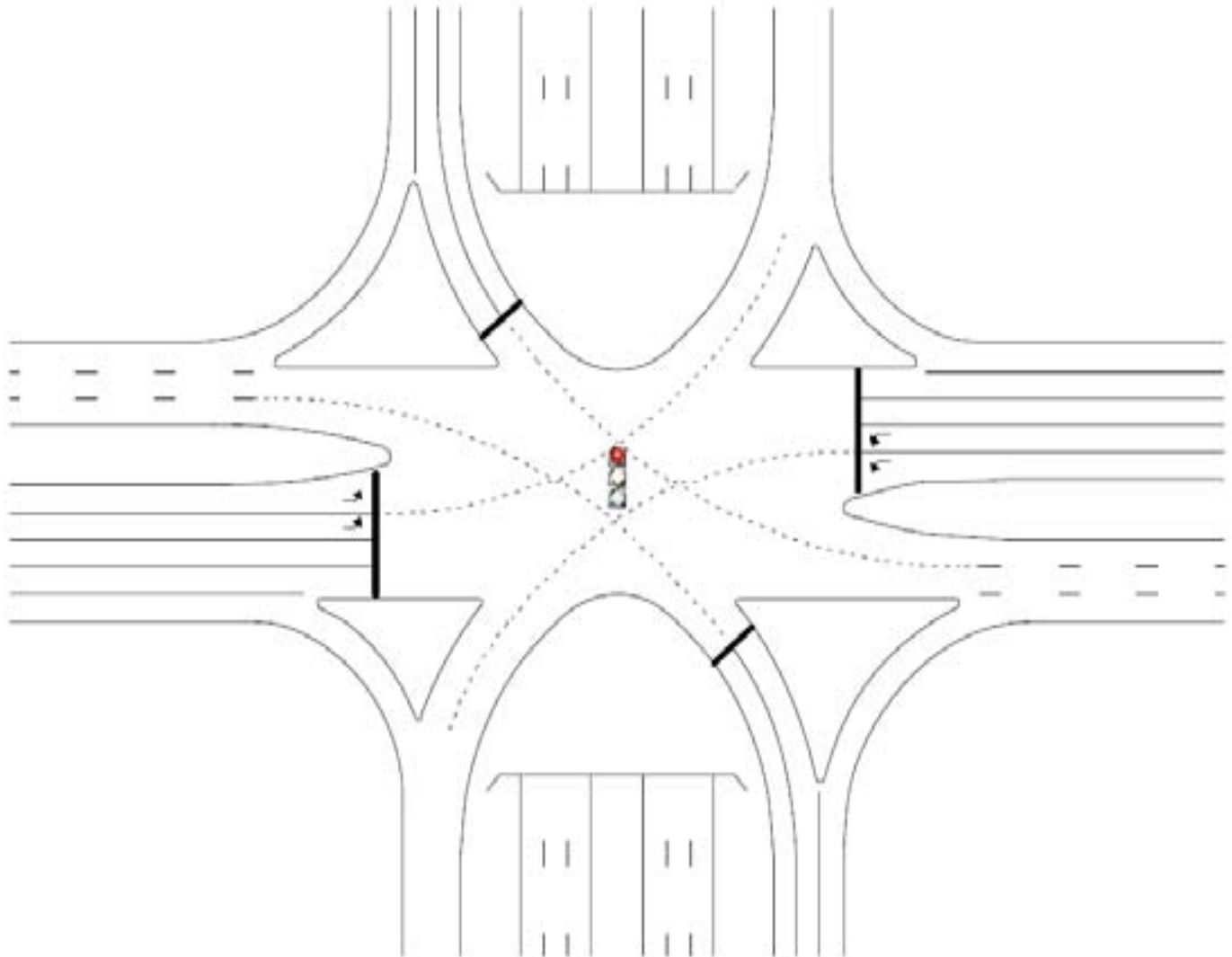

---

\* Added 7/17

## DOUBLE ROUNDABOUT INTERCHANGE\*

The Double Roundabout Interchange, alternatively referred to as a roundabout interchange, uses the concept of roundabouts at the grade-separated interchange. In effect, the minor street through movements navigate through roundabouts. There can be two types of roundabout interchanges—double and single. The double roundabout version uses two roundabouts at the ramp terminals. The single roundabout type has a single large roundabout designed over the arterial and serves as the overpass for the turning movements

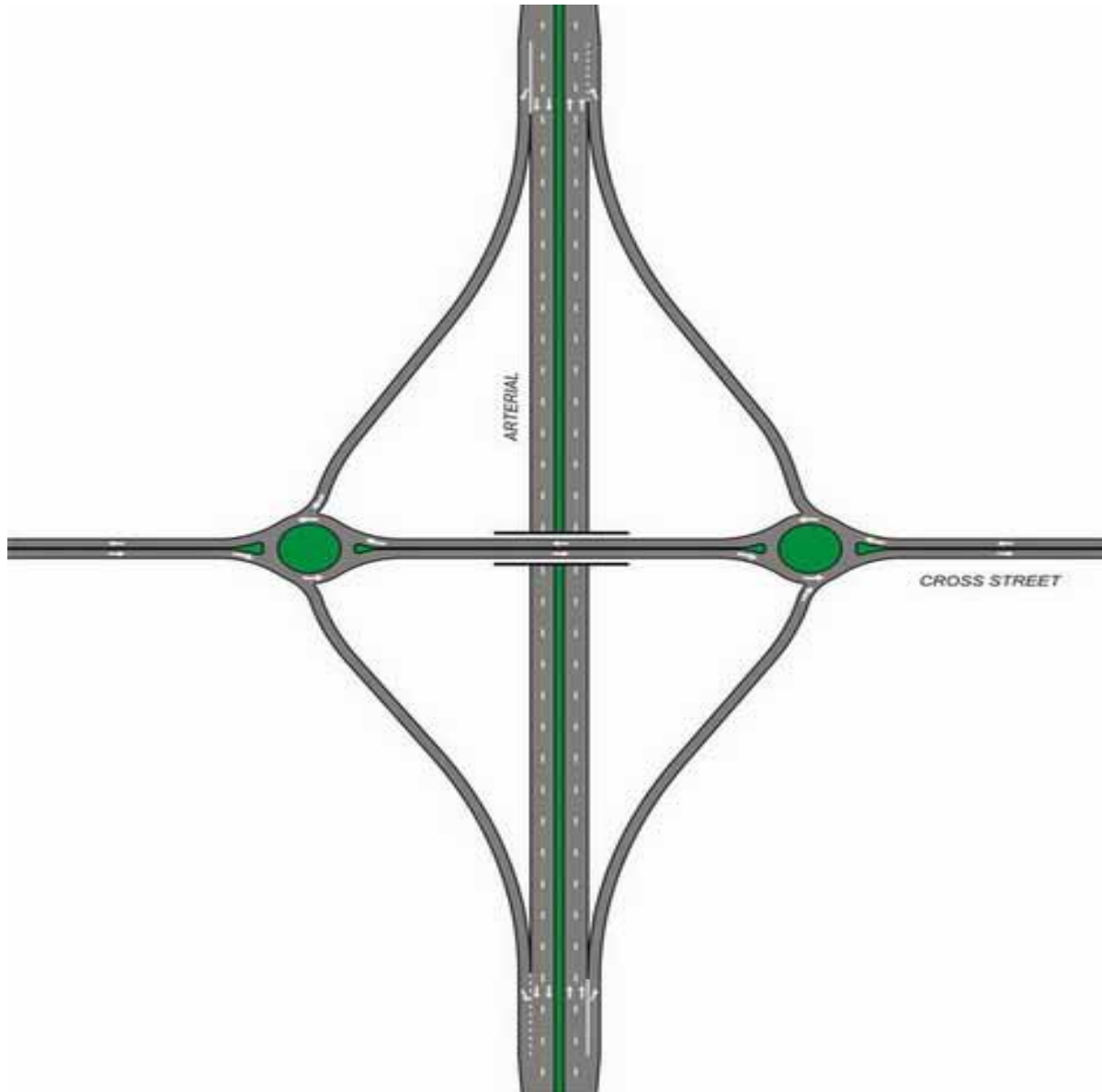

For more information on the above mentioned Innovative Interchange Designs see: [https://safety.fhwa.dot.gov/intersection/alter\\_design/](https://safety.fhwa.dot.gov/intersection/alter_design/)

---

\* Added 7/17

## **SECTION A-4-GUIDELINES FOR RRR PROJECTS**

### **OBJECTIVE**

The objective of the Virginia RRR Guidelines is to provide guidelines in the selection of projects where, with minimal improvements, the service life of the existing highway can be extended for a fraction of the cost of complete reconstruction.

Resurfacing, restoration, and rehabilitation (RRR) projects primarily involve work on an existing roadway surface and/or subsurface. In addition to extending the service life of the roadway, the purpose of RRR projects includes providing additional pavement strength, restoring or improving the existing cross section, decreasing noise characteristics, improving the ride of the roadway, improving bridges, and enhancing safety through the implementation of appropriate safety improvements, bridge improvements and preventive maintenance of bridges on appropriate Federal-Aid roadways. Highway Bridge Replacement and Rehabilitation Program (HBRRP) Funds may be utilized for preventative maintenance (PM) for the purpose of system preservation activities on Federal-Aid roadways except for those classified as local roads or rural minor collectors. Routine maintenance remains the responsibility of VDOT and/or locality.\*

Section 309 of the National Highway System Designation Act of 1995 (23 USC 116) states: "A preventive maintenance activity shall be eligible for Federal assistance under this title if the State demonstrates through the use of a systematic process, such as a Bridge Management System, to the satisfaction of the Secretary that the activity is a cost-effective means of extending the useful life of a Federal-Aid highway."

The scope of a RRR project is influenced by many factors. Factors include roadside conditions, environmental concerns, changing traffic and land use patterns, surface deterioration rate, accident rates, funding constraints and scenic/historic areas.

Although RRR type improvements are normally accomplished within the existing right of way, the acquisition of additional right of way may be necessary. Horizontal and vertical alignment modifications, when required, are generally minor.

---

\* Rev. 1/06

## AUTHORITY

The Transportation Research Board's *Special Report 214, Designing Safer Roads, Practices for Resurfacing, Restoration, and Rehabilitation, 1987*, was the result of a study on safety cost-effectiveness of highway geometric design standards for RRR projects. Virginia has developed and adopted this guideline for non-NHS RRR projects.

In the planning and design of any Secondary System improvements in rural areas, Virginia's RRR Guidelines shall be utilized to the extent possible.

Reconstruction under AASHTO design guidelines should be proposed on these projects only when the preliminary study report documents either:

1. The needed improvement is ineligible for development under the RRR concept.  
or
2. Extenuating circumstances preclude the use of the RRR Design concept.

Virginia RRR Guidelines may be utilized in improvements to urban streets for which the localities receive maintenance payments.

## DEFINITIONS

These definitions apply to RRR projects and are not an attempt to be all-inclusive of other related activities.

Maintenance - This work is directed toward preservation of the existing roadway and related appurtenances as necessary for safe and efficient operation. Design improvements are not normally the intent of maintenance operations. Seal coats, overlays less than 2 inches\* thick, crack sealing, etc., are considered maintenance items, and are not RRR activities.

Resurfacing - The addition of a layer, or layers, of paving material to provide additional structural integrity or improved serviceability and ride ability.

Restoration - Work performed on pavement, or bridge decks, to render them suitable for an additional stage of construction. This may include supplementing the existing roadway by increasing surfacing and paving courses to provide structural capability, and widening up to a total of ten feet. Restoration will generally be performed within the existing right of way.

Rehabilitation - Similar to "Restoration", except the work may include restoring structural integrity or correcting major safety defects of bridges, reworking or strengthening the base or subbase, recycling or reworking existing materials to improve their structural integrity, adding underdrains, improving or widening shoulders, and shifts in both vertical and horizontal alignment involving less than 50 percent of the project length. Rehabilitation may require acquisition of additional right of way.

---

\* Rev. 1/10

Reconstruction - This type of project is not considered RRR activity. A reconstruction project is designed in accordance with AASHTO design guidelines for new and major reconstruction projects and may include significant changes in cross section and shifts in both vertical and horizontal alignment. If 50 percent or more of the alignment changes, the project will be considered reconstruction. Reconstruction may require acquisition of additional right of way and may include all items of work usually associated with new construction.

## PROJECT SELECTION

Projects are identified and selected based on a variety of factors with the pavement condition being of utmost importance. The pavement condition itself will not have a significant effect on the extent of geometric improvements included in the project. Geometric improvements will be initiated to fulfill traffic service/safety needs.

Logical project termini are to be set; and, at no time, are project exceptions for segments of roadway or bridge, etc., to be established within the project termini due to excessive cost to provide the required improvements.

## ELIGIBILITY

Improvements to Existing Roadway\*:

### Eligible Items of Work \*

- Minor alterations to vertical and/or horizontal alignment.
- Minor lane and/or shoulder widening.
- Pavement structure and joint repair.
- Resurfacing (non-maintenance activities).
- Removal or protection of roadside obstacles.
- Repairs to restore bridge structural integrity, installation of deck protective systems and upgrading substandard bridge rail.
- Culvert Extensions.
- Repair or replace culverts.
- Restoration & relocation of curbs and gutters, raised medians, storm sewers, and other urban type improvements.

---

\* Rev. 1/06

- Some RRR-type projects may be funded with either regular Federal-Aid or separate categorical aid.

Examples:

Bridge rehabilitation project - RRR funding or the bridge replacement and rehabilitation program.

Roadside hazard removal and guardrail installation - RRR funding or hazard elimination program funds.

#### Ineligible Items of Work

- National Highway System (NHS). However some projects may be eligible, see “PREVENTIVE MAINTENANCE (PM) PROJECTS / RRR PROJECTS UTILIZING FEDERAL FUNDING ON NATIONAL HIGHWAY SYSTEM (NHS) ROADWAYS” at the end of Section A-4 for guidelines.
- New or additional through lanes.
- New Curbs and gutters, raised medians, storm sewers, and other new urban type improvements.

### **ACCIDENT RECORDS**

Evaluation of accident records often reveals problems requiring special attention. In addition, relative accident rates can be an important factor in establishing both the priority and the scope of RRR projects.

The Project Manager must request from the Traffic Engineering Division that the accident history for the project area be compiled and compared to the statewide average accident rate for the same type of road. This data review can be an integral part of the RRR project development process so that feasible safety modifications can be incorporated into the project as necessary.

The accident analysis shall be completed prior to the project field inspection/review and available for field review by the Federal Highway Administration.

### **BRIDGE REHABILITATION OR REPLACEMENT SELECTION POLICY**

See VOLUME V – PART 2 DESIGN AIDS AND TYPICAL DETAILS, Chapter 6 – Geometrics, which can be accessed at <http://www.virginiadot.org/business/bridge-manuals-default.asp>.

---

\* Rev. 1/12



## ENVIRONMENTAL CONSIDERATIONS

An environmental evaluation and documentation thereof, is required on all RRR Federal participation projects in accordance with current guidelines.

Prints are transmitted to the Environmental Engineer via Form [LD-252](#).

## ACCESS CONTROL

Generally, a RRR project will not be designated as a [limited access](#) highway due to the project being along an existing corridor with access provided to adjoining properties.

The elimination of existing access to properties is beyond the scope of work for RRR projects.

Existing limited access roadways may qualify as a RRR project.

## PROJECT DEVELOPMENT

It is desirable that these projects be designed to meet the standards for new construction. If meeting these standards is not practical, due to limited funding, right of way and/or environmental restrictions, etc., improvements in roadway widths should still be considered.

The design should not decrease the existing geometrics. Widths selected should be consistent throughout a given section. Minor lane and shoulder widening is acceptable. While additional new continuous traffic lanes are an ineligible type of work, the existing pavement may be widened up to a total of ten feet.

## ROADWAY AND TRAVELWAY WIDTHS

The minimum roadway and travelway widths are shown under GEOMETRIC DESIGN CRITERIA, TABLE A-4-1. Lane and shoulder width requirements are provided for roadways with 10% or more trucks and for roadways with less than 10% trucks.\*

Wide lanes and shoulders provide motorists with increased separation between overtaking and meeting vehicles and an opportunity for safe recovery of vehicles leaving the road.

Additional safety benefits include reduced interruption of the traffic flow as the result of emergency stopping and road maintenance activities, less pavement and shoulder damage at the lane edge, and improved sight distance for horizontal curves.

---

\* Rev. 7/12

## DESIGN TRAFFIC VOLUMES

Traffic projections should be checked to assure that:

The anticipated traffic being used is correct and that the roadway and travelway needs will be properly accommodated for the service life of the improvement.

The project service life for RRR projects should be from 8 to 12 years.

Turning movements are obtained at signalized and problem intersections and at major traffic generators.

Future traffic generators that are anticipated to be established during the service life should be considered.

## DESIGN SPEED

The design speed designated for a RRR project should be logical with respect to the character of terrain and type of highway and should be as high as practicable.

It is also important to consider the geometric conditions of adjacent sections of roadway when considering a RRR project. A uniform design speed should be maintained for a significant section of highway.

The design speed is a determining factor for required lane and shoulder widths. The following two methods may be used to determine the project design speed:

- (1) Select an overall project design speed that equals or exceeds the posted or regulatory speed on the section of highway being improved.
- (2) The average running speed throughout the project based on the "low volume" off peak hour traffic.

Average running speed is the speed of a vehicle over a specified section of highway, being the distance traveled divided by the running time (the time the vehicle is in motion).

An equivalent average running speed can be obtained on an existing facility where flow is reasonably continuous by measuring the spot speed.

The average spot speed is the arithmetic mean of the speeds of all traffic at a specified point.

For short sections of highway on which speed characteristics do not vary materially, the average spot speed may be considered as being representative of the average running speed.

On longer stretches of rural highway, spot speeds measured at several points, where each represents the speed characteristics pertinent to a selected segment of highway, may be averaged (taking relative lengths into account) to represent the average running speed.

## TERRAIN

Terrain is a significant factor which must be given strong consideration when establishing design criteria for a highway project. High design speeds (50 MPH and greater) can generally be achieved on flat terrain, and lower design speeds (45\* MPH and lower) are generally dictated by rolling and mountainous terrain, (depending upon road classification). Intermediate design speeds are determined by a combination of these factors.

While terrain is an important factor to be considered when designing a new project, RRR projects must be designed considering all existing constraints, and held within RRR parameters. That is to say that eligible RRR elements, due to terrain and other constraints upon the original design, may not allow the desired speed and safety enhancements.

## SAFETY

All safety elements of the project are to be given specific consideration. Accidents, accident types, and accident rates for the project length shall be examined and documented.

The documentation may indicate deficiencies in one or more of the following areas, however, each should be examined:

- Horizontal and vertical alignment
- Cross-sectional geometrics
- Traffic control
- Access
- Railroad crossings
- Pedestrian facilities
- Bridges that remain in place
- Illumination
- Signing
- Channelization
- Intersections
- Pavement edge drop offs
- Pavement surface condition
- Maintenance of traffic
- Bicycle facilities

Improvements to the roadway surface may result in increased operating speeds. Geometrics should be examined and modified, if necessary, to maintain an acceptable level of operational safety.

Horizontal and vertical curvature and stopping sight distance are directly related to the speed of vehicles and major deviations from the desirable design may cause serious problems. These geometric characteristics can be the most difficult and costly to improve. Although every sight distance restriction can create a potential hazard, improvement on that basis alone may not be practical on every RRR project.

---

\* Rev. 7/12

If curvature is shown to be the cause of numerous accidents, some corrective action should be taken. This corrective action can range from some form of positive guidance, which may include placement of additional warning signs and markings, to reconstruction.

Alignment improvements should be undertaken when accident experience is high, and if previously installed warning signs, markings, or other devices have not proven effective. In many cases, under both rural and urban conditions, existing horizontal and vertical alignments may be retained if a careful analysis indicates they can be adequately signed and marked.

Sight distance on horizontal curves, and at intersections, can often be improved by minor cut slope flattening, selective clearing or both. If such work is done, the actual sight distance must be measured, the maximum safe speed determined, and the location signed and marked accordingly.

A completed Roadside Safety Assessment is required to be performed by the **responsible District Traffic Engineer.**\* This will provide information regarding areas of potential concern relating to safety.

For safety, it is desirable to provide a roadside recovery area that is as wide as practical, but because of existing topographic features and right of way limitations associated with RRR work, considerable judgment must be used. The clear zone must be given particular attention at identified high roadside accident locations (fixed object and run-off-the-road accidents). An evaluation should be made to determine the consistency of the clear zone throughout the project limits.

Widening to provide more clear distance through short sections of rock cuts should be considered. In longer rock cuts, protrusions should be cut back or shielded if warranted. A review of accident data will help to define dangerous obstructions. Good engineering judgment, cost effectiveness, and consideration of community impact may also influence decisions.

---

\* Rev. 1/17

Under urban conditions the minimum setback for any obstructions should be as close to the right of way line as possible or 1.5 feet behind the curb. Where sidewalks are to be included, it is desirable to locate all obstructions behind the sidewalk.

Safety items for reducing the severity of run-off-the-road accidents include traffic barriers (including bridge rails), flattening slopes to eliminate the need for either existing barrier or contemplated barrier placement, crash cushions, breakaway or yielding sign supports, and breakaway luminaire supports.

The priority for action relative to roadside hazards is to:

- Remove or redesign
- Relocate
- Make breakaway
- Redirect by using appropriate barrier
- Delineate

To enhance safety, all RRR projects should provide the following:

Evaluation of existing traffic barrier and end treatments to determine whether they are necessary and meet applicable guidelines and standards. The extent to which the barrier must be upgraded should be consistent.

Appropriate transition and connection of approach rail to bridge rail.

Mitered end sections for both parallel and cross-drain structures located in the clear zone.

Relocating, shielding, or providing breakaway features for sign supports and luminaires.

Protection for exposed bridge piers and abutments.

Drop inlets with traversable grates that are not a hazard to be used within the clear zone.

## GEOMETRIC DESIGN CRITERIA

The design criteria in Table A-4-1 for Minor Arterial, Collector and Local Road projects are based on the general approach in the "AASHTO Book" regarding functional classification and corresponding appropriate design volumes and also recommendations presented in TRB special Report 214, Practices for Resurfacing, Restoration, and Rehabilitation.

MINIMUM LANE AND SHOULDER WIDTH VALUES								
ARTERIAL/ COLLECTOR/ LOCAL ROAD AND STREET SYSTEMS								
DESIGN TRAFFIC VOLUME	DESIGN SPEED MPH	10% OR MORE TRUCKS (d)			LESS THAN 10% TRUCKS (d)			DITCH WIDTH 3:1 FRONT SLOPE
		LANE WIDTH		SHOULDER WIDTH (c)	LANE WIDTH		SHOULDER WIDTH (c)	
ADT (a)	(b)	C&G (FT.)	W/SHLD (FT.)		(FT.)	C&G (FT.)		W/SHLD (FT.)
1 - 750	< 50	11 (e)	10 (e)	2 (i)	10	9	2 (i)	3 (h)
	≥ 50	11	10	2 (i)	11	10	2 (i)	3 (h)
751 - 2000	< 50	11	11 (f)	2 (i)	11	10	2 (i)	3
	≥ 50	12	12 (g)	3 (i)	11	11	3 (i)	3
2001 - 4000	ALL	12	12	6	11	11	6	4
4001 - OVER	ALL	12	12	6	11	11	6	4

**TABLE A-4-1 GEOMETRIC DESIGN CRITERIA**

- (a) Design traffic volume is between 8 and 12 years from completion.
- (b) Highway segments should be classified as "Under 50" only if most vehicles have an average running speed of less than 50 MPH over the length of the segment.
- (c) Cut shoulder width may be reduced by one foot in mountainous terrain.
- (d) Trucks are defined as heavy vehicles with six or more tires.
- (e) Use 9' lane width for Rural/Local Road System with ADT of 1 - 250.  
(9' lane width is equal to new construction standards for Rural/Local Road System)  
Use 10' lane width with Curb and Gutter for Urban with ADT 1-250  
(10' lane width is equal to new construction standards)
- (f) Use 10' lane width for Collector Road and Local Road System in mountainous terrain. (10' lane width is equal to new construction standards.)
- (g) Use 11' lane width for Collector Road and Local Road System in level terrain. (11' lane width is equal to new construction standards.)
- (h) Use 2' ditch width with pavement depths (excluding cement stabilized courses) of 8" and less.
- (i) Minimum width of 4' if roadside barrier is utilized (minimum 2' from edge of pavement to face of G.R.).  
(See Guardrail Installation Standard, Section 500, in VDOT Road and Bridge Standards).

NOTE: PAVEMENT AND SHOULDER WIDTHS NOTED ARE MINIMUMS FROM A DESIGN CRITERIA STANDPOINT. UNDER NO CIRCUMSTANCES SHALL THE EXISTING PAVEMENT OR SHOULDER WIDTHS BE REDUCED TO CONFORM TO THESE MINIMUM STANDARDS.

NOTE: FOR VALUES NOT SHOWN, SEE APPROPRIATE GEOMETRIC DESIGN STANDARD FOR THE FUNCTIONAL CLASSIFICATION OF ROADWAY (GS-2, GS-3 OR GS-4) CONTAINED IN THE VDOT ROAD DESIGN MANUAL, APPENDIX A, SECTION A-1.

NOTE: ROADSIDE HAZARDS AND PRIORITY FOR RELATIVE ACTION ARE COVERED ON PAGE A-33.

## **CLEAR ZONES AND SLOPES**

Wherever possible, existing side slopes should not be steepened when widening lanes and shoulders. When the initial slopes are relatively flat, however, the slope can be steepened to 6:1 with little effect, and steepening to 4:1 may be reasonable.

Consideration should be given to flattening side slopes of 3:1 or steeper at locations where run-off-the-road type accidents are likely to occur (e.g. on the outsides of horizontal curves). Accident data should be used (when available) to substantiate run-off-the-road accident locations.

Removing, relocating or shielding of isolated roadside obstacles should be evaluated in accordance with the Clear Zone and Traffic Barrier Guidelines contained in the Road Design Manual, Appendix A, Sections A-2 and A-3.

## **GRADES**

Grades generally do not need to be flattened on RRR projects. Steep grades and restricted horizontal or vertical curvature in combination, however, may warrant corrective action.

## **CREST VERTICAL CURVES**

An existing vertical curve may be retained as is, without further evaluation, if the existing design speed provides the stopping sight distance within 15 MPH of the overall project design speed and the average daily traffic volume is less than 750 vehicles per day.

Reconstruction of crest vertical curves is to be evaluated when the above speed and traffic volumes are exceeded and the vertical curve hides major hazards from view. Major hazards include, but are not limited to intersections or entrances, sharp horizontal curves and narrow bridges.

## **SAG VERTICAL CURVES**

Substandard sag vertical curves should be investigated to ensure that potential hazards do not exist, especially ones that become apparent when weather conditions, or darkness, reduce visibility.

## STOPPING SIGHT DISTANCES

Guidelines for determining the existing sight distances of vertical and horizontal curves are as follows:

- Existing road data to be determined from survey plan and profile sheets and/or old plans obtained from the plan library.
- Road and Bridge Standards [SD-1](#) and [SD-4](#) may be used to determine the sight distances using the following methods:

Vertical curves - Determine algebraic differences of grades in percent and length of vertical curve in feet from the survey plans, or old project plans, and the sight distance may be obtained from Standard [SD-4](#).

Horizontal curves - Determine the existing degree of curve and the middle ordinate or radial distance from centerline of inside lane to obstruction to view and the sight distance may be obtained from Standard [SD-1](#).

- Vertical and horizontal curve sight distances may be scaled from the plans using the following heights of driver's eye and object:

<u>Sight Distance</u>	<u>Height of Eye</u>	<u>Height of Object</u>
Stopping	3.5'	2'
Passing	3.5'	3.5'

## HORIZONTAL CURVES

An existing horizontal curve may be retained as is, without further evaluation, if the existing curve design speed, with correct superelevation provided, corresponds to a speed that is within 15 MPH of the running speeds of approaching vehicles and the average daily traffic volume is less than 750 vehicles per day.

Reconstruction of horizontal curves should be considered and evaluated when the above speed and/or volume criteria are exceeded.

When a roadway segment consists of a series of reverse curves or curves connected by short tangents, the succession of curves shall be analyzed as a unit rather than as individual curves.

The first substandard curve in a series should receive special attention because this change in alignment prepares the driver for the remaining curves in the series.

Any intermediate curve in a series of substandard curves that is significantly worse than the others in the series should be analyzed individually.

These controlling curves can be used to determine the safety and/or other mitigation measures to apply throughout the series.



## **PAVEMENT CROSS SLOPE**

Pavement resurfacing or rehabilitation will be accomplished such that the finished pavement on tangent sections will be crowned in accordance with new construction standards.

## **SUPERELEVATION REQUIREMENTS**

Standard superelevation will be provided on all curves to comply with the project design speed unless the following conditions exist:

- Excessive cost to provide superelevation.
- Excessive property damage.

Superelevations may be provided for design speeds up to a maximum of 15 MPH less than the project design speed for current traffic volumes of 750 vehicles per day or less, if the above conditions exist, with appropriate signing:

- Advisory curve signs and speed limit signs will be erected.

## **PAVEMENT EDGE DROP**

Pavement edge drops usually are caused by resurfacing of pavement without regrading the existing shoulder or erosion of gravel, turf, or earth shoulder materials.

This hazard shall be eliminated or mitigated by utilizing one or more of the following practices:

- Paving the full top width between shoulder breaks.

- Selectively paving shoulders at points where vehicle encroachments are likely to create pavement edge drops, such as on the inside of horizontal curves.

- Constructing a beveled or tapered pavement edge so that any edge drop that develops has a reduced impact on the recovery maneuver.

- Reconstruction of shoulders.

## **INTERSECTIONS**

Many intersection improvements can be made at a relatively low cost and are safety cost-effective, particularly at higher traffic volumes.

The intersection improvements must be tailored to site-specific conditions and rely heavily on professional judgment and experience along with current Department guidelines.

## DESIGN EXCEPTIONS

All efforts should be made to adhere to the standards stated herein. However, it may be necessary to use values that are less than the minimum values shown. If lesser values are proposed for use, a design exception will be needed and approval by the State Location and Design Engineer and the Federal Highway Administration on Federal aid funded projects must be granted before developing the project further.

Methods of showing design exceptions on the plans are noted in Instructional and Informational Memorandum IIM-LD-227. Design Exceptions are to be requested on Form LD-440, maintained on the VDOT website at <http://vdotforms.vdot.virginia.gov/>. If approved, the completed Form LD-440 is to be attached to Form PM-100\* Scoping Report for submittal at advertisement stage.

## PLANNING DRAINAGE DESIGN ELEMENTS

The hydraulic consequences of a highway improvement need to be addressed during the planning phase of the project.

Failure to assess the hydraulic aspects of the improvement could result in an increase in damages to adjacent property as well as the highway facility. Although detailed site information may not be required, it is important that a hydraulic assessment be made by a drainage engineer in the planning phase to determine that engineering and regulatory constraints can be met.

Items to be considered include:

- Hydraulic impacts
- Interaction with other agencies
- Utilities
- R/W and property owners' concerns
- Environmental concerns and permits

## REPLACEMENT OR REHABILITATION OF DRAINAGE ELEMENTS

The decision to rehabilitate or replace a structure should not be made without checking hydraulic adequacy. Normally, the highway designs that improve upstream flooding conditions should generally result from meeting highway flooding criteria. Scour protection, spur dikes, or other protective measures should be included with the bridge rehabilitation.

The decision regarding the rehabilitation or replacement of existing bridges or culverts is often a structural or functional decision. Hydraulic input is important when the cost of the rehabilitation is high enough to consider replacement or where the contemplated rehabilitation involves a change in the roadway profile which, by lessening roadway overflow, could increase hydraulic stresses on the structure and change flow distribution.

---

\* Rev. 7/16

Rehabilitation or replacement of culverts often becomes necessary when the culvert is no longer structurally sound. Consideration of the remaining service life of the existing culvert is, therefore, a very important factor in deciding to rehabilitate or to replace it.

In some instances, structures may require replacement due to inadequate waterway area and subsequent frequent interruption of traffic due to flooding. Prolonged ponding behind an embankment caused by an inadequate culvert may also lead to embankment saturation or piping along the culvert.

## **HYDRAULIC CHARACTERISTICS**

The hydraulic considerations for RRR improvement projects are, in many respects, the same as those for a highway on new alignment. The primary difference is that the hydraulic characteristics of the existing facility are already established. These hydraulic characteristics include:

- Culvert performance (inlet or outlet control or headwater at culvert sites).
- Culvert outlet velocities and scour tendencies.
- Flow lines and culvert alignment.
- Backwater at bridge sites.
- Flow distribution.
- Scour patterns at bridge piers, bridge abutments and adjacent banks.
- Skew and channel alignment.
- Storm drain systems and their performance.

The engineer must consider the need for changing and the consequences of changes to these hydraulic characteristics.

Most improvement projects will require some modification of the existing drainage structures. If the hydraulic performance of a drainage structure is changed, the change should be investigated for both upstream and downstream effects of the change.

Because the hydraulic effects of existing structures are usually well established, there is sometimes opposition to change from the landowner(s) affected. This is particularly true in developed areas.

Debris conditions may be changed and should be considered in design. Roadside ditch drainage patterns may be altered. These conditions should be thoroughly studied before any change is allowed.

## **SAFETY IMPROVEMENTS RELATIVE TO DRAINAGE DESIGN**

Where the hazard is a culvert headwall, the options usually are to extend the culvert, protect traffic with guardrail, or construct a protective grate over the headwall. The alternative selected should be based on particular site conditions. Grates on cross culverts with the potential to collect significant debris are undesirable because of the potential hazard created for local flooding. A good way to evaluate the risk is to assume the grate will be plugged and then determine what flood hazard will be created. In all cases, it is very important that grates on culvert end be inspected frequently and always cleared of debris. Spaces between grate bars should be as large as practicable in order to lessen the probability of plugging.

The wide openings tend to minimize the flood hazard by reducing the potential of debris plugging the culvert.

## **BRIDGE RESTORATION**

Hydraulically Equivalent Replacement Structure (HERS) definition:

The waterway opening of the proposed structure provides the same height, width obstructions (piers) and geometric configuration as the existing structure.

The proposed roadway grades on the approaches and the structure provide the same overtopping characteristics as the existing facility.

Any of the above characteristics of the proposed facility are less restrictive to the passage of flood flows than are the characteristics of the existing facility.

Every waterway crossing whose 1% exceedance probability discharge is anticipated, estimated or expected to be 500 cfs or greater **MUST** be reviewed by an appropriate river mechanics specialist. When the proposed facility is determined to be the hydraulic equivalent of the existing facility, no formal design analysis will be required.

If a rehabilitation of the structure and/or its approach roadway does not conform to the HERS requirements, it must be treated as a bridge replacement, and an engineering analysis is required.

## **BRIDGE REHABILITATION**

Bridge repairs are often required because of structural deterioration, damage from floods, and damage from vehicles. Bridge rehabilitation consists of physical changes to a bridge which are necessary because of inadequate width, structural capacity, hydraulic capacity, or because of scour or degradation.

Where bridge repair or rehabilitation is being considered, the cost of the repair should be compared with the cost of complete replacement. The hydraulic requirements of the bridge should also be reviewed when extensive repair or rehabilitation is being contemplated. This hydraulic review is particularly important if a change in the roadway profile is to be included in the rehabilitation.

In some cases, the grade may be raised so that roadway overflow is eliminated without changing the bridge size. This can be a deliberate change of the grade or a slow change, such as maintenance forces placing asphalt overlays on the grade over a period of years. These changes should always be reviewed by the hydraulics design section for effect on flow distribution, on backwater, and on velocity through the bridges.

A replacement bridge may have a deeper superstructure and solid rails. These differences will affect a stream crossing unless compensating adjustments are made in the profile grade line.

Where the profile grade is raised, the effect may be to eliminate or lessen roadway overflow which could force more water to flow through the bridge opening. Solid rails can have the same effect. If the grade is lowered, the flow pattern and the amount of flow directed over the road and into downstream property could be increased.

When replacement bridges have shorter spans than the existing bridge, the resulting increase in the number of piers could add debris and scour problems or increase backwater.

## **CULVERT REPLACEMENT**

When an existing culvert is to be replaced, an analysis should be made to see if the size of the existing culvert is either smaller or larger than necessary.

## **CULVERT REHABILITATION**

A properly installed culvert generally loses its structural integrity through corrosion and/or abrasion of its invert, although overall loss of material in the pipe wall can occur, some installations due to the corrosive action of the backfill material or the water flowing through the culvert. Common restoration techniques include:

- Provision for replacement of the culvert invert.

- Threading of a smaller size culvert or liner plate through the original culvert and grouting of the voids between the two culverts.

- Use of commercial products for relining pipe with epoxy-coated fabric materials.

Any proposed culvert rehabilitation scheme should be analyzed for hydraulic adequacy and outlet protection. Normally, the smaller cross sectional area resulting from culvert rehabilitation will lead to higher headwater elevation; however, this effect may be insignificant if there is storage upstream or if the potential for damage is minimal. Another consequence of a reduction in pipe size may be higher outlet velocities. This factor should also be assessed during the design of a culvert rehabilitation project.

Use of smooth linings, improved inlets, etc. may also improve the hydraulic performance of the relined culvert and essentially offset the loss of cross sectional area.

Many older culverts were built during a period when less attention was given to the need for accommodating fish passage. Such accommodations can often be incorporated by the addition of baffles in the culvert barrel; however, such designs should be checked to ensure that the revised design is hydraulically adequate.

## **CULVERT EXTENSIONS**

The extension of an existing culvert can result in significant changes to the hydraulic performance. Extending the inlet of a culvert operating in inlet control establishes a higher inlet flow line, which will raise the inlet headwater elevation an equal amount. Extending a culvert which operates under outlet control may also increase the headwater because of head losses associated with the longer barrel.

Culvert extensions can cause the approach or the exit flow alignment to be unacceptable. This can usually be corrected by either extending the culvert on a skew angle that will fit the channel alignment or modifying the channel.

Long culvert extensions could cause the culvert to switch from inlet control to barrel (outlet) control, which will result in an increase in headwater.

In addition to the above noted changes, a long culvert extension may also create problems with fish passage through the culvert that should be addressed during the design.

## **SIGNING, SIGNALS AND PAVEMENT MARKINGS**

Traffic control devices such as signing, signals, and pavement markings must be updated in accordance with the [Manual on Uniform Traffic Control Devices](#) and the VDOT's [Road and Bridge Standards](#).

While traffic control devices cannot fully mitigate all problems associated with substandard geometric features, they are a relatively low cost measure that can compensate for certain operational deficiencies.

Where roadway geometry or other roadway or roadside features are less than standard, do not meet the driver's expectancy, and reconstruction is not feasible, additional signs, markings, delineation and other devices beyond normal requirements of the [MUTCD](#) should be considered.

Judicious use of special traffic regulations, positive guidance techniques, and traffic operational improvements can often forestall expensive reconstruction by minimizing or eliminating adverse safety and operational features on or along existing highways.

Signals are to be provided at warranted locations.

## **PLAN REVIEWS**

Preliminary Plan Reviews and Field Inspections are to be held in accordance with the standard procedures. The Federal Highway Administration (FHWA) is to be notified of each and invited to attend.

## **PUBLIC INVOLVEMENT**

RRR projects are to be developed utilizing the Department's Public Involvement Policy to keep the public sufficiently informed and involved as the project progresses so that a formal public hearing can be eliminated in most, if not all, cases.

## **RIGHT OF WAY**

Although RRR type improvements are normally made within the existing right of way, additional right of way may be required to provide the necessary improvements.

Any required right of way and/or easements will normally be secured by donation. However, right of way may be acquired.

All right of way negotiations are to be conducted in accordance with the applicable statutes, regulations, policies, and procedures stipulated in the Right of Way and Utilities Division's Manual of Instructions and related memoranda.

## **UTILITIES (UNDERGROUND AND OVERHEAD)**

Where utilities are involved on RRR projects, the Department's General Guidelines for Accommodating Utilities Within Highway Right of way are to be followed.

Relocation or adjustment may be required if the minimum clear zone requirements are not met or if the utility system conflicts with proposed RRR improvements and sufficient right of way is available. For Federally funded RRR projects, an exception request must be made if the project does not meet the minimum clear zone requirements.

In some cases, the utility system on RRR projects may be retained without adjustment or relocation if the accident history does not indicate the existence of a hazard or if the system has demonstrated adequate performance and does not conflict with proposed improvements.

## **TORT LIABILITY AND GEOMETRIC DESIGN**

In recent years highway agency administrations have become increasingly concerned about the growth of tort claims. Such claims allege that highway agencies have committed a legal wrong by improper or negligent highway design, operation, or maintenance that became a cause or partial cause of a highway accident. Claims against highway agencies are part of a nationwide problem of rising liability insurance premiums and increasing costs of tort actions.

Studies indicate that the geometric design features covered in RRR standards are usually not the central focus of tort claims. Pavement features, traffic control devices, and roadside barriers account for the large majority of tort claims.

## **BACKGROUND ON TORT LIABILITY**

Tort is defined as a civil wrong or injury, and a tort action seeks repayment for damages to property and injuries to an individual. If a defendant is found negligent in his actions, or lack of action, he is liable for a tort claim and must compensate the plaintiff. State laws and rulings differ regarding tort claims against a governmental entity. In Virginia, as in most states, the courts or state legislatures have eliminated sovereign immunity (whereby an individual cannot sue the state or its agents for negligence).

Highway agencies are spending substantial sums as a result of tort claims. The costs of handling tort claims include not only the direct costs of judgment awards, settlements, and insurance, but also attorneys' fees and the cost of engineers' and other staff time.

Negligence can be alleged on two grounds particularly relevant to highway agencies:

- Agency (or person) improperly performs its duties (misfeasance).
- Agency (or person) fails to perform its duties (nonfeasance).

## **RRR IMPROVEMENTS AND TORT CLAIMS**

Little is known about how frequently the geometric features addressed by RRR design standards are cited in tort claims against highway agencies. Few states maintain data on tort claims by alleged defect. Further, classifying tort lawsuits is difficult because most involve several defects that differ in importance.

Geometric features (such as cross-sections, alignment, and intersections) usually covered by RRR standards account for a small percentage of total claims filed against highway agencies. Of the cases in which a geometric feature is at issue, horizontal and vertical curves are the most often cited.

Pavement features including edge drops, potholes, surface deterioration and slippery pavements, account for large amounts of the settlement costs.

## **SUSCEPTIBILITY OF RRR PROJECTS AND STANDARDS TO TORT CLAIMS**

The standards selected for RRR projects, the design process followed, and the scope of the improvements may influence the litigation of future tort claims. The issues that might arise in a tort action are:

- Did the project meet the appropriate design standards?
- Are the standards reasonable?
- Was the design process reasonable?
- Did the improvements correct existing dangers?
- Should unimproved roads be judged by standards used for roads that are improved?



The resolution of tort claims alleging an inadequate geometric design is contingent on determining the appropriate set of design standards used to assess negligence.

Determining whether a highway improvement project is sufficiently extensive to qualify as reconstruction can be a key issue in a tort claim because reconstruction projects usually must meet current new construction standards.

Deficient roadside signs or pavement markings and pavement edge-drop problems, which are often the basis of tort claims, can be routinely corrected on RRR projects.

## **DEFENSE OF A RRR PROJECT DESIGN**

Although planning and design activities are exempt from liability in most states, this immunity has been held not to apply to decisions made without prior study or conscious deliberation.

Documentation of the planning process should be part of the state highway agency's defense.

For RRR projects, documentation should demonstrate that safety aspects of the roadway design were properly considered. Reports that identify deficiencies in existing roadways are potentially threatening to the public agency preparing the report if the deficiencies are not addressed. Thus, if any exception to an applicable design standard was granted, documentation should explain the reasons for the exception and show that logic and orderly procedures were followed in obtaining it.

When a highway agency contemplates a design exception for a geometric or roadside feature, it should be prepared to prove why the feature need not meet the same standards as other facets of the roadway design. Often, the best defense in this situation is to demonstrate that the safety cost-effectiveness of further upgrading the feature does not meet any reasonable criteria.

Courts seldom rule that the unavailability of funds is justification for not correcting an alleged defect, but the issue of availability of funds can be part of the defense in relation to the agency's programming procedures.

The following points are important to such a defense:

- The agency is aware of the condition of its facilities
- Deficiencies have been ranked on a logical basis
- Given the existing funding, items are being corrected in the order of priority
- Appropriate warnings or other temporary measures should be used to alert the public that deficiencies have not been corrected. The highway agency can then affirm that it has performed its duties in the best way possible with the available resources.

In order to receive immunity for planning and design activities, a state must thoroughly document the design process in order to defend challenges.

A rational and orderly process must be followed if a plan or design is to be considered immune from claims of negligence. If a feature built during construction was not called for in the plans or was altered from the specifications, it is open to a claim of negligence in a tort action.

## **RRR NOTES ON PROJECT TITLE SHEET**

For applicable projects, the following note shall be placed on the plan [title sheet](#) under the Functional Classification and Traffic Data Block:

NOTE: THESE PLANS WERE DESIGNED IN ACCORDANCE WITH VIRGINIA RRR GUIDELINES.

### **PREVENTIVE MAINTENANCE (PM) PROJECTS / RRR PROJECTS UTILIZING FEDERAL FUNDING ON NATIONAL HIGHWAY SYSTEM (NHS) ROADWAYS\***

On April 28, 2009 VDOT and FHWA signed an Agreement for Maintenance Projects on the National Highway System (NHS) to utilize federal funding to perform maintenance/resurfacing, restoration, and rehabilitation (RRR) type work across the Commonwealth. A number of meetings were held between FHWA and VDOT's Location and Design and Maintenance Divisions to discuss the Scope for these type projects, establish a process for the development of these type projects, and to agree upon the level of involvement/oversight that the FHWA will provide. The FHWA and VDOT recognize the fact that the intent of these projects is to preserve the existing infrastructure and provide additional service life for the roadway and/or bridges through a particular corridor with the appropriate level of Preliminary Engineering expenses and a short design/construction time period. FHWA and VDOT agree that by developing guidelines that will provide clarification, flexibility and structure to the use of maintenance/RRR criteria, it will reduce inefficiencies in preliminary engineering and improve these types of projects across the Commonwealth.

---

\* Rev.7/09

The guardrail for both RRR and Preventive Maintenance (PM) projects shall be reviewed for proper height. In cases where the guardrail height is less than 26 inches, it shall be reset as part of the RRR project. The guardrail in preventive maintenance projects will be reset if the paving operations resulted in a reduction of guardrail height.\*

It is agreed that FHWA will be invited to briefing/scoping meetings for all PM and RRR projects on the Interstate. Since many of these projects will not meet the thresholds for "Full Oversight", FHWA will maintain a programmatic review of the process.

It is the intent of this policy is to identify the characteristics and document procedures to be used in the development of projects within each of the following two categories:

Category 1: Preventative maintenance and resurfacing.

Category 2: Heavy maintenance and RRR.

### **Category 1: Preventative Maintenance and Resurfacing:**

The activities must be clearly of a preventative measure as opposed to reacting once a corrective action is required. Projects that address deficiencies in pavement structure or increase capacity of the facility are not considered preventive maintenance. All preventative maintenance projects shall maintain and preserve the current level of safety and accessibility and consider additional low cost safety improvements.

#### Procedural steps for the development of Category 1 projects:

- Identify high crash locations throughout the proposed corridor and conduct a field review to determine isolated or obvious deficiencies that should be addressed as part of a future project.
- Determine whether additional safety improvements such as upgrading guardrail and end treatments, installation of traffic signs and pavement markings, and edge line rumble strips should be included in the proposed project where they are determined to be a cost effective way to improve safety. In no way shall preventative maintenance type projects adversely impact the safety of the traveled way or its users.

---

\* Rev.7/09

- It is agreed that to maintain program flexibility, and in accordance with 23 U.S.C. 109(q), safety improvements for preventative maintenance projects can be deferred and included in future projects in the Statewide Transportation Improvement Program (STIP). It is expected that safety improvements would be programmed within 2 years of the preventative maintenance project. However, extensions beyond the two years can be made with the approval of FHWA. Roadside hardware upgrades will be implemented in accordance with [Appendix I](#) in this manual.\*
- Projects shall have an appropriate environmental document to satisfy the National Environmental Policy Act (NEPA), generally a Programmatic Categorical Exclusion (PCE) prepared by the VDOT District Environmental Unit.

#### **Examples of eligible activities under Category 1:**

- Corrosion protection activities (Area wide program)
- Highway sign face cleaning (Area wide program)
- Any corrective, restorative or rehabilitative/reconstruction of highway pavement, which extends the service life of pavement for 5 – 15 years
- Milling and replacement of pavement materials
- Addition of a layer or layers of paving materials. (<2.0")
- Replacing surface treatment materials with plant mix asphalt
- Concrete joint sealing
- Diamond grinding of concrete surface
- Thin concrete overlay
- Crack sealing of mainline asphalt pavement or shoulders
- Applying surface treatments to mainline asphalt pavement or shoulders (example: chip seals, slurry seals, latex/micro-surfacing, thin friction course, etc)
- Thin hot mix asphalt overlay (<2.0")
- Grouting, mud jacking and under sealing
- Retro fitting of dowel bars
- Shoulder pulling and wedging for pavement edge drop-off mitigation

#### **Eligible bridge related activities under Category 1:**

- Seal or replace leaking joints, reconstruction of joint areas during joint replacement or elimination of deck joints.
- Deck overlays. (Thin bonded overlays, rigid overlays, and asphalt overlays with waterproof membranes).
- Spot and zone painting/coating of structural steel to include bearings for pre-stressed concrete members.

---

\* Rev. 7/16

- Painting/coating of structural steel.
- Cathodic Protection (CP) Systems for Bridge Decks.
- Cathodic Protection Systems for Substructure Elements.
- Cathodic Protection Systems for Superstructure Elements other than decks.
- Electrochemical Chloride Extraction (ECE) Treatment for decks.
- Electrochemical Chloride Extraction Treatment for substructure elements.
- Scour countermeasures installation.
- Removing large debris from channels.
- Retrofit of fracture critical members.
- Retrofit of fatigue prone details. (Methods to increase the fatigue life of fatigue prone details, like using ultrasonic impact treatment on welds at ends of cover plates or connection plates welds not positively connected to flanges.)
- Concrete deck repairs in conjunction with installation of deck overlays, CP systems, or ECE treatment.
- Substructure concrete repairs in conjunction with installation of CP systems, ECE treatment, or galvanic anodes (when there are several sources or experimental basis when only one source). (Includes substructure units with cathodic protection jackets.)
- Application of sealants, coatings, and membranes for surface protection of the concrete.
- Bridge cleaning and/or washing service. (Decks, joints, drains, superstructure and substructure horizontal elements.)
- Place concrete mat along the flow line of steel pipe culverts.

NOTE: When eligible substructure work and/or painting/coating of ends of girders under joint locations are leaking, then it is required to have a contract for the work during the same year or the following year to seal the joints.

### **Category 2: Heavy Maintenance and RRR:**

The purpose for this category project is to restore and rehabilitate the pavement structure to extend the service life of the corridor by 15 to 20 years. Projects will typically involve variable depth milling and pavement build up, minimal changes to the vertical and horizontal alignment, include guardrail and roadside hardware improvements and will stay within the existing right of way. The pavement structure may be removed and replaced in its entirety for up to 50% of the project length. Projects will not provide for additional capacity through the corridor. This work is not considered preventive maintenance because of the improvements to the pavement structure.\*

---

\* Rev. 7/09

Procedural steps for the development of Category 2 projects:<sup>\*</sup>

- VDOT will review the proposed project to validate that the scope and purpose meets the intent of a RRR project as outlined in this letter.
- Engineering design and analysis will be done to ascertain locations of existing or potential congestion and safety concerns. This analysis will be conducted with the following in mind:
  - (1) Early in the project development phase, VDOT will analyze the proposed project location to establish the applicable controlling design criteria. Any existing geometric features that are not brought up to current standards but meet the design standard during original construction/reconstruction will be documented by VDOT in the project files and copies sent to FHWA for their concurrence. The documentation will be in accordance with VDOT's Road Design Manual, Section A-4, Guidelines for RRR Projects (or any subsequent revisions to the guidelines).
  - (2) The controlling design criteria for Interstate projects are the design criteria used in the original construction or most recent reconstruction. For example, if a project was constructed in 1964, the standards in place at that time and any design exceptions approved at that time would be the allowable design criteria for the RRR project. This is allowed per AASHTO's A Policy on Design Standards Interstate System.
  - (3) VDOT will provide formal design exceptions only for those instances where an existing geometric feature is made worse. In these instances, VDOT will provide the same level of engineering and documentation and follow the normal steps associated with processing a design exception for FHWA approval. However, every effort will be made to bring these substandard geometric features to current AASHTO design standards.
- Road Safety Audits will be conducted to identify low cost safety countermeasures such as Rumble Strips and Rumble Stripes, Median Barriers, Safety Edges, Left and Right Turn Lanes at Stop-controlled Intersections, Yellow Change Intervals, Medians and Pedestrian Refuge areas and Walkways and will be included in the proposed project where they are determined to be cost effective by the project manager and agreed to by the project team.
- Projects shall have an appropriate environmental document to satisfy NEPA, generally a Programmatic Categorical Exclusion (PCE) prepared by the VDOT District Environmental Unit.

---

\* Rev. 7/09

**SECTION A-5-BICYCLE AND PEDESTRIAN FACILITY GUIDELINES**

**This information is now located in [Appendix A\(1\)](#)**

## **SECTION A-6 AIRPORT CLEARANCE REQUIREMENTS**

During the Project Planning Stage, the Designer will determine if there is a potential for substandard airway - highway clearance, or other potential hazard, as determined by the project's location listed below:

1. Within 20,000 feet of public use or military airports with at least one runway greater than 3,200 feet in length.
2. Within 10,000 feet of public use or military airports with runways with a length of 3200 feet or less.
3. Within 5,000 feet of public use, military, or hospital heliports.
4. Any permanent or temporary construction or alteration including any equipment, materials or apparatus that would be more than 200 feet in height above ground level at its site.
5. Construction of wetlands or stormwater management ponds within 5 miles of a public use or military airport.

The Designer will request a review and coordinate notice requirements for any project determined to be within the applicable limits as listed above. A list of airports, as of the printing of these instructions, is provided at the end of this section for assistance in locating applicable airports. The request for review will be made to the Location & Design Airport Clearance Coordinator in the Photogrammetry and Survey Section by Form [LD-252](#).

The Airport Clearance Coordinator will determine current Federal Aviation Administration (FAA) requirements pertaining to the subject project and notify the FAA as early as possible. Part 77 of the Federal Aviation Regulations and the U. S. Department of Transportation FAA Advisory Circular 70/7460-21 contain FAA requirements as of the printing of these instructions.

All evaluations will be determined by using U.S.G.S. or N.G.S. (U.S.C. & G.S.) datum or datum matching quadrangle sheets. In no case will assumed data or local city or town datum be used.

When a new corridor is being developed or an existing corridor is being redeveloped to add lanes, interchanges, etc., the entire corridor is to be reviewed for clearance requirements at a very early stage.

For Final Design, the corridor will probably be divided into multiple projects and be handled by different design sections and/or in a District Office. The establishment of the proposed grade elevations based on the airport clearance requirements at an early stage is important because grade adjustments on a Final Design Project by a section may create major design adjustments on an adjoining project that is being prepared by another section or District Office.



When lighting is required on a project or a possible addition in the future, the pole heights are to be considered in the initial review for clearance requirements. Although a highway may present no problems with vertical clearances, the use of certain types of materials (such as fencing, lighting, etc.) may affect navigational equipment. Also, the use of large construction equipment (such as cranes) may cause encroachment of navigable airspace. Encroachment problems may also result from signs and/or lighting added several years after the roadway completion.

When proposed construction or maintenance activities initiated by other Divisions (i.e. Environmental, Structure and Bridge, Maintenance, Traffic Engineering) or a District Office are within the limits (specified earlier in this section) of airports or heliports, the Location and Design Highway Airport Clearance Coordinator is to be notified by Form [LD-252](#).

When potential clearance conflicts are determined, the designer will contract the Highway Airport Clearance Coordinator via Form [LD-252](#) and request a review. The Designer will submit Form [LD-252](#); one (1) print of the title, typical section(s), and applicable plan and profile sheets for the Highway Airport Clearance Coordinator's review.

The Highway Airport Clearance Coordinator will evaluate the appropriate desirable clearance dimensions between highway surfaces and airway approach zones and, if necessary, request that the designer furnish prints of applicable project plan sheets. This is for early communication between the FHWA, FAA, and the Department and for alerting the FAA of potential hazards to aviation.

When a potential problem exists, FAA Form 7460-1 (notice of proposed construction or alteration), or current form, along with appropriate project review data will be filled by the Highway Airport Clearance Coordinator. A Notice of Construction or Alteration to the Federal Aviation Administrator is required for any proposed construction or alteration. This applies to, but is not limited to, the following:

1. Any object of natural growth or terrain.
2. Permanent or temporary construction or alteration, including equipment or materials used therein, and/or apparatus of a permanent or temporary character.
3. Structures with a change in height (including appurtenances) or lateral dimensions, including equipment or materials used therein.
4. Proposed changes in the land use practices that would attract or sustain hazardous wildlife populations at or near airports.

**ASSOCIATED CITY    PUBLIC-USE\* AIRPORT**

Abingdon	Virginia Highlands Airport
Blacksburg	Virginia Tech-Montgomery Executive Airport
Blackstone	Allen C. Perkinson Municipal Airport
Bridgewater	Bridgewater Air Park
Brookneal	Brookneal-Campbell County Airport
Bumpass	Lake Anna Airport
Charlottesville	Charlottesville-Albemarle Airport
Chase City	Chase City Municipal Airport
Chesapeake	Chesapeake Regional Airport
Clarksville	Marks Municipal Airport
Crewe	Crewe Municipal Airport
Culpeper	Culpeper Regional Airport
Danville	Danville Regional Airport
Dublin	New River Valley Airport
Emporia	Emporia-Greenville Municipal Airport
Farmville	Farmville Regional Airport
Forest	New London Airport
Franklin	Franklin Municipal Airport
Fredericksburg	Shannon Airport
Fredericksburg	Stafford Regional Airport
Front Royal	Front Royal-Warren County Airport
Galax/Hillsville	Twin County Airport
Gordonsville	Gordonsville Municipal Airport
Grundy	Grundy Municipal Airport
Hot Springs	Ingall's Field
Jonesville	Lee County Airport
Kenbridge	Lunenburg County Airport
Lawrenceville	Lawrenceville-Brunswick Municipal Airport
Leesburg	Leesburg Executive Airport
Louisa	Louisa County Airport
Luray	Luray Caverns Airports
Lynchburg	Falwell Airport
Lynchburg	Lynchburg Regional Airport
Manassas	Manassas Regional Airport
Marion	Mountain Empire Airport

-continued-

(continued list of airports)

<b><u>ASSOCIATED CITY</u></b>	<b><u>PUBLIC-USE AIRPORT</u></b>
Martinsville	Blue Ridge Airport
Melfa	Accomack County Airport
Moneta	Smith Mountain Lake Airport
New Market	New Market Airport
Newport News	Newport News-Williamsburg International Airport
Norfolk	Norfolk International Airport
Orange	Orange County Airport
Petersburg	Dinwiddie Airport
Portsmouth	Hampton Roads Executive Airport
Quinton	New Kent County Airport
Richland	Tazewell County Airport
Richmond	Richmond International Airport
Richmond	Chesterfield County Airport
Richmond	Hanover County Airport
Roanoke	Roanoke Regional Airport
Saluda	Hummel Field
South Boston	William M. Tuck Airport
South Hill	Mecklenburg-Brunswick Regional Airport
Staunton	Shenandoah Valley Regional Airport
Suffolk	Suffolk Executive Airport
Tangier	Tangier Island Airport
Tappahannock	Tappahannock-Essex County Airport
Wakefield	Wakefield Municipal Airport
Warrenton	Warrenton-Fauquier Airport
Washington, D.C.	Washington Dulles International Airport
Washington, D.C.	Washington National Airport
Waynesboro	Eagle's Nest
West Point	Middle Peninsula Regional Airport*
Williamsburg	Williamsburg - Jamestown Airport
Winchester	Winchester Regional Airport
Wise	Lonesome Pine Airport

<b><u>Associated Area</u></b>	<b><u>Military Airfields</u></b>
Fort Belvoir	Davidson AAF
Fort Eustis	Felker AAF
Norfolk	NAS Norfolk
Poquoson	Langley
Quantico	MCAF Quantico
Va. Beach	NAS Oceana
	NALF Fentress

\* Rev. 1/08

## **SECTION A-7-"NO PLAN" AND "MINIMUM PLAN" PROJECTS**

### **GENERAL CONCEPTS**

#### **Description**

The "No Plan" and "Minimum Plan" concepts provide for the accomplishment by contract of the type improvements that would not require complete and detailed surveys and plans, and where the use of standard Specifications would be appropriate.

Generally, the improvements will consist of widening, grading, draining and stabilizing primary and secondary roads with relatively low traffic volumes by using engineering judgment. Bridge/Structure improvements will consist of drainage structures, "bridge only" rehabilitation and replacement projects with minimal roadway approach work, bridge repair/maintenance and other engineered non-complex structures in nature. These types of projects are to be accomplished by the "Accelerated Bridge Plan" concept as defined in IIM-S&B-84. "No Plan" and "Minimum Plan" concepts are to be used only for projects where significant reductions in the cost/time of engineering, contract development and construction can be experienced by using these concepts to obtain the quality of improvement necessary for the particular situation. To optimize the usefulness of these concepts, very careful initial study and project selection by the District staff is required. The Federal Highway Administration has concurred with the use of the "No Plan" and "Minimum Plan" concepts on selected projects with Federal Oversight.

"No Plan" projects are used when—minimal survey is required to accomplish engineering, right of way and construction stakeout, and no major hydraulic analysis or river mechanics studies are needed. Right of way may be acquired on "No Plan" projects without the preparation of official plans as long as the value of the acquisition of each parcel does not exceed \$5,000. If the anticipated acquisition value is greater than \$5,000 per parcel or eminent domain will be required to acquire property, the information outlined in the Code of Virginia §33.2-1001 (see below) shall be developed and provided for each parcel on which a certificate is to be filed. A "No Plan" contract contains an assembly of letter size sketches showing the location of the project with a typical cross section and estimated quantities.

"No Plan" road projects and "Accelerated Bridge Plan" projects may be put together in a common contract in the same manner that a minimum plan (M) or construction plan (C) road project is contracted together with a bridge (B) project. When this is done, finished grade control must be provided through the limits of the 500 year flood plain at each bridge or major drainage structure located within the "No Plan" road project that requires a hydraulic analysis. When the contract contains an "Accelerated Bridge Plan" project the structure plans may consist of 8½" X 11" sketches inserted into the assembly or separate full scale bridge plans.

The current versions of the No Plan files are in **ProjectWise**\* in the sub-directory for No Plan under Engineering Services (eng-ser).

---

\* Rev. 7/18

A "Minimum Plan" project requires survey and topo to provide sufficient right of way plans necessary for the acquisition of right of way by the Right of Way Division and plan, profile and cross section sheets are to be provided. In the establishment of such projects, attention should be given to determine that the project location and selection is in an area where disruption due to construction can be tolerated by the users of that particular roadway for a reasonable period of time.

The "Accelerated Bridge Plan" process may be used with structures requiring "B" or "D" designation numbers and other structures requiring major hydraulic analysis or river mechanics studies, and may also be used for bridge repair/maintenance and other engineered structures when pertinent survey, exploration and engineering are needed. For "Accelerated Bridge Plan" projects, the plan submittal may consist of 8½" X 11" sketches inserted into the assembly or separate full scale bridge plans.

## **PUBLIC HEARING AND RIGHT OF WAY**

All right of way negotiations are to be conducted in accordance with the applicable statutes, regulations, policies, and procedures stipulated in the Right of Way Division's Manual of Instructions and related memoranda.

For "No Plan" projects any required right of way and/or easements will be secured by donation provided no condemnation is requested and no condemnation is required. However, right of way may be purchased without the preparation of official plans as long as the value of the acquisition of each parcel does not exceed \$5,000, which does not include incidental cost, such as fencing, shrubbery, etc. If the anticipated acquisition value is greater than \$5,000 per parcel or eminent domain is required the information as outlined in the Code of Virginia §[33.2-1001](#)\* (see below) shall be developed and provided for each parcel on which a certificate is filed.

The Code of Virginia §[33.2-1001](#) states the Following:

"If Right of Way is purchased the following information shall be provided: (i) the giving of plans and profile drawings of the project, showing cuts and fills, together with elevations and grades; (ii) explanation, in lay terms, of all proposed changes in profile, elevation and grade of the highway and entrances, including the elevations of proposed pavement and shoulders, both center and edges, with relation to the present pavement, and approximate grade of entrances to the property."

To accompany the plat we need a plan view, profiles of road and entrances and cross sections. The plan area shown should extend about 100 feet on each side of the property to be condemned. If just beyond that is a major feature such as a large drainage pipe, box culvert, SWB, etc. the limits should probably be expanded as it may have some impact on the property value.

---

\* Rev. 10/14

The plan should show the property boundary and all topographic features on the property (within the normal distance into the property) and all existing roadway features. The proposed roadway features (pavement, entrances, drainage, retaining walls, construction limits, guardrail, etc.) should be shown as well as the proposed right of way and easement limits. While not needed for the plans any drainage calculations should be retained in the file.

Right of Way Division will issue a Notice to Proceed on "No Plan" projects when incidental costs, such as fencing, shrubbery, etc. occur. Activity 52 should be added to iPM because of the costs.

The Commonwealth Transportation Board's resolution of February 16, 1961 specifies a minimum 40-foot right of way is to be provided for any initial improvement to the secondary system, except in extenuating circumstances.

Section [33.2-332](#), Code of Virginia permits consideration for hard surfacing of a secondary road on less than a 40-foot right of way.

#### Right of Way - Donations

An exception to the public hearing requirement will normally be executed on "No Plan" and "Minimum Plan" projects when all landowners are willing to donate the right of way provided there is no evidence of controversy, the landowners have been advised of their right to receive just compensation prior to requesting donations, and the project files have been so documented.

#### Right of Way - Acquisitions

On "No Plan" and "Minimum Plan" projects when right of way must be acquired, a "Willingness to Hold a Public Hearing" shall be advertised and public hearings shall be conducted upon request. A public hearing handout and appropriate environmental document, on projects with Federal Oversight, will be prepared following the usual guidelines. If there are questions concerning the public hearing requirements or procedures, check with the State Location and Design Engineer.

#### Right of Way – Certification

Type I certificates are required on all No Plan and Minimum Plan projects with the exception that a Type II certificate may be used if approved by the District Engineer/Administrator or his designee.

---

\* Rev. 7/15

## **SPECIAL DESIGN STRUCTURES, SOIL SURVEY AND PAVEMENT DESIGN**

"No Plan" projects may include standard drainage structures or channel modifications that do not require a hydraulic study. Major structures with "B" or "D" designation numbers, major channel modifications or other structures that require a hydraulic study may be constructed under the "Accelerated Bridge Plan" concept. Separate bid items are to be set up when needed.

The District Materials section is to review the project site to determine if soil samples may be necessary. The District Materials Engineer is to furnish recommendations regarding any undercutting or pipe bedding requirements and pavement design.

## **MOBILIZATION AND FIELD OFFICE**

Mobilization is to be set up as a contract item on "No Plan" and "Minimum Plan" projects in accordance with VDOT's Road and Bridge Specifications.

When it is necessary to set up a field office, it is set up as a contract item in accordance with VDOT's Road and Bridge Specifications at the discretion of the District; however, other arrangements should be considered such as the use of existing facilities where feasible to eliminate the need for the extra cost of a field office.

## **DRAINAGE FACILITIES AND EROSION AND SEDIMENT CONTROL MEASURES**

For all land disturbance activities that disturb an area equal to or greater than 10,000 square feet or 2,500 square feet or greater in Tidewater Virginia\*\* an Erosion and Sediment Control (ESC) Plan and a Stormwater Pollution Prevention Plan (SWPPP) must be prepared and included in the contract documents. The appropriate notes on the SWPPP General Information Sheets must be completed and included in the plan set or other such contract documents. Guidelines for developing and approving an ESC Plan are contained in the latest version of VDOT's [Drainage Manual](#). Guidelines for completing the SWPPP General Information Sheets are contained in [Chapter 10](#) of the latest version of VDOT's [Drainage Manual](#).

Temporary and permanent erosion and sediment control measures are required in accordance with the Department's approved ESC and SWM Standards and Specifications. Plan details must accompany any plan narrative and shall denote the type and location of proposed erosion and sediment control measures.

Seeding operations, erosion, and sedimentation control measures shall be included as specific contract items in accordance with standard specifications and procedures. All drainage facilities shall be designed in accordance with the appropriate design criteria noted in the VDOT Drainage Manual and shall comply with Minimum Standard 19 of the Virginia Erosion and Sediment Control Law and Regulations.

\*\* Tidewater, VA, as defined by the Virginia Chesapeake Bay Preservation Act, Title 10.1, Chapter 21, Code of Virginia.

---

\* Rev. 8/16

## **VPDES CONSTRUCTION GENERAL PERMIT AND POST CONSTRUCTION STORMWATER MANAGEMENT:**

All land disturbing activities that disturb an area equal to or greater than one acre in size require coverage under the General VPDES Permit for Discharges of Stormwater from Construction Activities (VPDES Construction General Permit) issued by DEQ. Land disturbing activities located in Chesapeake Bay Preservation Areas that disturb between 2,500 square feet and up to one acre are not required to have construction permit coverage but are regulated by certain technical criteria and administrative requirements of the VSMP regulations. Routine maintenance activities are exempt from the VSMP Regulations and VPDES Construction General Permit but are regulated by the ESC Law and Regulations. (See the current version of [IIM-LD-242](#) for additional information).

Post construction stormwater management has become complex with the current VSMP Regulations. Designers should engage stormwater requirements at the earliest stage of project development to ensure the purpose and need of the project can be accomplished. (See [IIM-LD-195](#) and the VDOT Drainage Manual for additional information).\*

## **CONTRACT TIME LIMIT**

Generally, a fixed contract completion date should be established. However, the contract time limit should be determined after thorough consideration of the need to realize the lowest cost possible to provide the improvement at the earliest practical date.

## **PROCEDURES**

### **General Description of Work**

A general description of the work must be provided on the Project Narrative to denote the nature of the work to be performed, such as daylighting of slopes; realignment; intersection improvement; or widening of shoulders and ditch lines are to be completed by the District Engineer/Administrator's Staff. For VDOT advertised projects [Form C-99](#) (No Plan and Minimum Plan Quantity Support Report) should be used. "Simple" sketches may be used in lieu of the narrative. They are to be submitted with the project assembly for the purpose of providing information concerning the general description of construction work from which to develop and support the construction cost estimate.

## **PROJECT SCOPING FIELD REVIEW**

All projects are to be scoped and a Field Review is to be held in accordance with [PM-100](#) these procedures will define the potential need for field and office engineering as well as right of way and environmental requirements.

---

\* Rev. 8/16



## "NO PLAN" PROJECTS

The "No Plan" concept may be used when:

- (a) Minimal or no survey is required to accomplish engineering, right of way and construction stakeout.
- (b) Improvements to roadways do not involve major structures with "B" or "D" designation numbers, channel modifications or special design items
- (c) Major hydraulic analysis or river mechanics studies are not required.
- (d) Rights of way are acquired through donations and no condemnation is required.
- (e) Environmental permits including VSMP Construction Permit coverage will not normally be required
- (f) Construction & Plan/Contract Development activities must be handled in an expeditious manner
- (g) Engineering is required

Projects that may be developed with the "No Plan" concept include, but are not limited to:

- (a) Addition of Turn lanes
- (b) Shoulder Widening, Ditch Work, Minor Relocation and Alignment Work
- (c) Intersection Improvements
- (d) Sidewalks and Curb Ramps
- (e) Safety Improvements
- (f) Guardrail Upgrade and Replacement
- (g) Pavement Overlays and Pavement Markers and Markings
- (h) Maintenance Operations
- (i) Sign, Signal and Luminaire Repair and Replacement

"No Plan" projects and "Accelerated Bridge Plan" projects may be combined into the same contract. When the "Accelerated Bridge Plan" project involves a stream/river crossing, finished grade control shall be provided through the 500 year flood plain at each bridge or drainage structure.

District \*Engineer/Administrator's Staff normally obtains any donated right of way by use of the appropriate Right of Way Forms. When a "No Plan" project is to be constructed within existing right of way, a note must be placed on the title sheet indicating that "All construction is to be performed within existing right of way."

The construction baseline should generally follow the center of the existing roadway; however, minor relocation and alignment improvements (horizontal and vertical), roadway widening, and turn lanes may be accomplished. The geometrics should comply with the appropriate design standards. However, where it is impractical or not economical to obtain the minimum design and a design exception is required, permission shall be secured from the State Location and Design Engineer and, if applicable, from the State Structure and Bridge Engineer and/or Federal Highway Administration.

The VDOT Project Manager, with the assistance of the project team, determines the typical section and furnishes an estimate of quantities on the "Quantity Support Report" [Form C-99](#). Grading should generally be balanced and set up as a lump sum quantity. [Form C-99](#) should indicate an estimate of grading quantities, including anticipated waste quantities, to guide the Construction Division in preparing the construction cost estimate.

When borrow material is anticipated, "Borrow Excavation" is to be set up as a separate bid item in accordance with VDOT's [Road and Bridge Specifications](#). Borrow sources should be located and designated whenever possible in accordance with VDOT's [Road Design Manual Chapter 2E, Section 2E-1 - SOIL SURVEY AND PAVEMENT DESIGN](#).

A unit price for extra excavation is to be established by the District Administrator's staff and entered on [Form C-99](#) for inclusion in the contract assembly by the contract section.

The Project Manager is responsible for coordinating utility field inspections with the District Staff and preparing the field inspection reports. The District Engineer/Administrator's Staff is responsible for determining utility conflicts, method of adjustment, cost responsibility and for obtaining and forwarding all plans and estimates from utility owners to the District Engineer/Administrator (District Utilities Engineer) for approval and authorization. The District Engineer/Administrator (District Utilities Engineer) will then forward a copy of the approval and authorization letter to the Project Manager to be placed in the project.

The Project Manager or Responsible Charge is also responsible for notifying the District Engineer/Administrator's Staff (District Utilities Engineer) in writing, no later than 60 days prior to the advertisement of the project, that all arrangements have been made with the utility owners to relocate or adjust the utilities prior to or in conjunction with the project construction.

The Central Office Location and Design, Utilities Section will obtain any necessary FHWA authorization for utility work and will furnish utility clearances and estimates to the Construction Division for contract projects with federal funding. If no known utilities and/or railroads are involved, the plans will contain a note so stating.

The District Engineer/Administrator's Staff is responsible for the district project funding confirmation for "No Plan" Construction and Maintenance projects and shall sign the "No Plan" Title Sheet. For all other required signatures and Sealing and Signing, see the "No Plan" Title Sheet and Sealing and Signing Sheet, which can be found in [ProjectWise](#)\* under the eng\_ser directory, subfolder for "No Plan".

---

\* Rev. 7/18

The Project Manager or Responsible Change will submit stand alone "Accelerated Bridge Plan" assembly directly to the Construction Division for processing, construction advertisement and applicable federal authorization.

If the proposal and final estimate are developed by the District, the complete contract proposal (including all pertinent Copied Notes and Special Provisions and final estimate) shall be submitted no later than the Advertisement Plan Submission date (column 6 of the "No Plan" advertisement cut-off date chart). Federal criteria sheet shall be included in the submission.

If the proposal and final estimate are to be developed by the Construction Division, the appropriate documentation shall be submitted no later than the Contract Development date (column 2 of the "No Plan" advertisement cut-off date chart). Proposals shall be developed utilizing approved templates.

On Secondary "No Plan" projects, the project manager will submit the plan assembly directly to the Central Office Plan Coordination Section for processing. Plan coordination will forward the plan assembly to the Construction Division for construction advertisement or authorization for State Force work on projects with Federal Oversight, whichever is applicable.

Primary "No Plan" projects will continue to be submitted to the Central Office Plan Coordination Section for processing and approval for advertisement (See IIM-68 for Electronic Plan Submission). Construction plans will be retained in the District until right of way has been secured and arrangements made for utility adjustments. When retained, status reports (containing applicable correspondence) will be submitted by the District Engineer/Administrator's staff quarterly until all right of way is acquired and utilities are clear.

### **"MINIMUM PLAN" PROJECTS**

A "Minimum Plan" project requires survey and topo to provide sufficient right of way plans necessary for the acquisition of right of way by the Right of Way Division and plan, profile and cross section sheets are to be provided. In the establishment of such projects, attention should be given to determine that the project location and selection is in an area where disruption due to construction can be tolerated by the users of that particular roadway for a reasonable period of time.

Those projects that require an engineering design should be designated as "Minimum Plan" projects. This will provide the mechanism for the development of required engineering studies and will provide a vehicle for transmitting critical information to the contractor.

Projects that should be developed with the "Minimum Plan" concept include, but are not limited to:

- (a) Projects requiring more than minimal survey
- (b) Major stream crossing sites
- (c) Projects that will require environmental evaluation and/or permits
- (d) Projects requiring major hydraulic analysis or river mechanics studies
- (e) Projects that involve the acquisition of right of way and/or condemnation

The basic difference between the "Minimum Plan" and the "No Plan" project is the need for more than minimal survey and topo to provide sufficient right of way plans necessary to acquire right of way. Form RW-205 or individual deed forms are to be used. If any additional right of way or easements are necessary, the right of way certificate and release for advertisement will be required. If additional right of way or easements are not required, the "Minimum Plan" title sheet is to contain a note indicating that "All construction is to be performed within existing right of way."

"Minimum Plan" projects may include relocation or alignment improvements (horizontal or vertical), roadway widening, and the addition of turn lanes that involve the acquisition of right of way and/or condemnations.

A general description of work must be provided on [Form C-99](#) and the Field Narrative to denote additional work that is not covered on the plans.

Special attention should be given to major drainage sites and the limits set for the proposed right of way. The geometrics should comply with the appropriate design standards. However, where it is impractical or not economical to obtain minimum design standard an design exception is required, permission must be secured from the State Location and Design Engineer and, if applicable, from the Federal Highway Administration.

Quantities, typical sections, entrance profiles and other similar information should be shown on the initial plan and profile sheets. A grade line is required when the grade is to be different than that of the existing road. In areas where right of way is to be obtained and entrance grading is necessary, a profile showing the approximate grade of the proposed entrance should be included in the plan assembly.

When borrow material is anticipated, "Borrow Excavation" is to be set up as a separate bid item in accordance with Section 303 of VDOT's [Road and Bridge Specifications](#). Borrow sources should be located and designated, whenever possible, in accordance with VDOT's [Road Design Manual](#), [Chapter 2E](#), [Section 2E-1](#) - SOIL SURVEY AND PAVEMENT DESIGN.

A unit price for extra excavation is to be established by the District Construction Engineer or the District Engineer/Administrator's staff and entered on [Form C-99](#) for inclusion in the contract assembly by the contract section.

The Project Manager is responsible for coordinating utility field inspections with the District Engineer/Administrator (District Utilities Engineer) and preparing the field inspection reports. Utility adjustments shall be handled in accordance with [VDOT Survey Manual, Chapter 13](#)\* and Road Design Manual, Chapters 2E and 2G, which can be accessed at <http://www.virginiadot.org/business/locdes/rdmanual-index.asp>

---

\* Rev. 7/16

For all land disturbance activities that disturb an area equal to or greater than 10,000 square feet or 2,500 square feet or greater in the area defined as Tidewater Virginia\*\*, an Erosion and Sediment Control Plan and a Stormwater Pollution Prevention Plan (SWPPP) must be developed, reviewed, and approved by appropriate qualified personnel in accordance with the latest version of VDOT's [Drainage Manual](#).

\*\* Tidewater, VA, as defined by the Virginia Chesapeake Bay Preservation Act, Title 10.1, Chapter 21, Code of Virginia.

For all land disturbance activities that disturb one acre of land or greater or 2,500 square feet or greater in an area locally designated as a Chesapeake Bay Preservation Area, a Stormwater Management Plan must be developed, reviewed, and approved by appropriate qualified personnel in accordance with the latest version of VDOT's [Drainage Manual](#) and [IIM-LD-195](#).

## **PERMITS AND REVIEWS ("NO PLAN" AND "MINIMUM PLAN" PROJECTS)**

Historical and archaeological reviews are to be made. (Request Forms [LD-252](#) and [EQ-429](#)). The need for 401, 404, navigation, and other environmental permits are to be considered in accordance with the Guidelines for the Preparation of Permit Application. Any land disturbing activity that disturbs one acre or greater (or 2,500 square feet or greater in an area locally designated as a Chesapeake Bay Preservation Area, (except certain routine maintenance activities specifically exempted by the Virginia Stormwater Management Law and the Virginia Stormwater Management Program (VSMP) Permit Regulations - 4VAC50-30 et seq. and 4VAC50-60 et seq.) must have a project specific VSMP Construction Permit registration. Instructions for registering a project for VSMP Construction Permit coverage are contained in [IIM-LD-242](#). (Request Form [LD-445](#), [445A](#), [445B](#) and [445C](#))

## **PLAN PREPARATION**

The sample plan assemblies for both "No Plan" and "Minimum Plan" projects provide the manner of showing the minimum essential information and the notes necessary to govern construction. For the current version of the "No Plan" title sheet, see the CADD No Plan Directory, which is in [ProjectWise](#)\* under Engineering Services (eng-ser).

"Minimum Plan" title sheet shall include all the information as that shown on a "Construction Plan" title sheet. Variation may be made to the formats to meet the specific project needs and to best utilize all available sheet space, thereby minimizing the total number of project assembly sheets. Careful attention should be given to the notes shown thereon.

The Contractor shall perform all construction surveying on "No Plan" and "Minimum Plan" projects in accordance with the Special Provision "Copied Note" for Section 105.10 of VDOT's [Road and Bridge Specifications](#). (See VDOT [Survey Manual](#), Chapter 8).

---

\* Rev. 7/18

The plan assemblies for both “No Plan” and “Minimum Plan” projects are to be placed in ProjectWise and transmitted electronically. The document assembly instructions are located in ProjectWise along with the other typical drawings needed for “No Plan” and “Minimum Plan” projects.

Generally, plan variations from AASHTO guidelines, as set forth in the Geometric Design Standards (See VDOT's Road Design Manual, Appendix A), are not readily apparent in an Reassembly (consisting of the plan details, Form C-99, cost analysis, and narrative or description of the work) by the VDOT Project Manager and/or District Engineer/Administrator.

When “Minimum Plan” roadway projects are combined with “Accelerated Bridge Plan” projects, the proposal and final estimate will be developed by the Construction Division.

## **SPECIFICATIONS**

It is intended that modified versions of parts of VDOT's Road and Bridge Specifications will be followed in order to reduce the field engineering and final computations required; however, the use of such modifications must still be consistent with good construction practices in relation to the kind and type of improvement being provided and must comply with the Department's Approved Erosion and Sediment Control and Stormwater Management Standards and Specifications and the Virginia Stormwater Management Program Laws and Regulations.

A unit price for extra excavation is to be established by the District Construction Engineer or the District Engineer/Administrator's staff and entered on Form C-99 for inclusion in the contract assembly by the contract section.

The Special Provisions for "No Plan" and "Minimum Plan" Projects (available from VDOT's Construction Division) are approved by the Federal Highway Administration for use on a project by project basis. When additional changes to the Specifications are necessary, such changes should be documented and submitted with the project assembly. Any additional Special Provisions are to be reviewed by the Construction Division in ample time for inclusion in the project bid proposal.

Generally, materials from sources that have proven to be satisfactory in the past will normally be accepted by certification as determined by VDOT's Materials Division, subject to visual inspection at the project site.

The Contractor shall perform all construction surveying on "No Plan" and "Minimum Plan" projects in accordance with the Special Provision "Copied Note" for Section 105.10 of VDOT's Road and Bridge Specifications. (See VDOT Survey Manual, Chapter 8).

Prospective bidders may be required to attend the Project Showing as a prerequisite for submitting a bid proposal for "No Plan" and "Minimum Plan" projects. When attendance is required, prospective bidders must register with the Engineer at the project showing and all attending parties are to be noted in the project showing letter. The Area Construction Engineer or Construction Manager and the Project Inspector must also attend the project showing. The Field Narrative will indicate if attendance is required.

## **PROJECT LAYOUT**

If deemed necessary by the District **Engineer/Administrator** or District Construction Engineer, marked stakes shall be established showing the approximate depth at centerline of major fills and cuts which exceed 4 feet and/or other areas as required. Marked stakes shall be in place at the time of the Project Showing.

Survey work for "Minimum Plan" projects should normally be performed in accordance with the VDOT Survey Instructions Manual or as otherwise determined by the District **Engineer/Administrator** or District Construction Engineer. The designer should determine in the early stages of the plan development where additional survey is needed in order to alleviate any major problem during construction. For entrance profiles on "Minimum Plan" projects see [Appendix "F" – Section 4 – Entrances Affected by Highway Construction Projects](#).

## **INSPECTION AND RECORD KEEPING**

Close coordination between the Project Inspector and the Contractor is necessary to assure the success of the "No Plan" and "Minimum Plan" concepts.

One loose leaf notebook is normally necessary on a "No Plan" or "Minimum Plan" project for use as a combination diary, materials book, and sketch book provided that electronic versions of these materials are not available.

Alignment and sketches may be entered in accordance with standard procedures or, where feasible, small sketches may be glued into the notebook to properly indicate the work performed.

Where it is determined by the District that "As Built Plans" are more practical, they may be used in lieu of entering alignment, sketches, and summaries in the notebook. When "As Built Plans" are used, any changes, additions, or deletions of any nature are to be clearly indicated on the prints/files furnished to the Inspector with the diary and materials information entered in the notebook.

All documents pertaining to the SWPPP for the project shall be kept in an individual notebook or folder and shall be available for review upon request during normal working business hours (See VDOT's [Drainage Manual](#)).

Upon the completion of a project, all records shall be submitted in accordance with standard procedures; except that after verification of the materials section by the District Materials Engineer, a reproducible copy of the materials section of the notebook/file is to be furnished to the State Materials Engineer in lieu of furnishing the original document/file.





# PROJECT LOCATION MAP

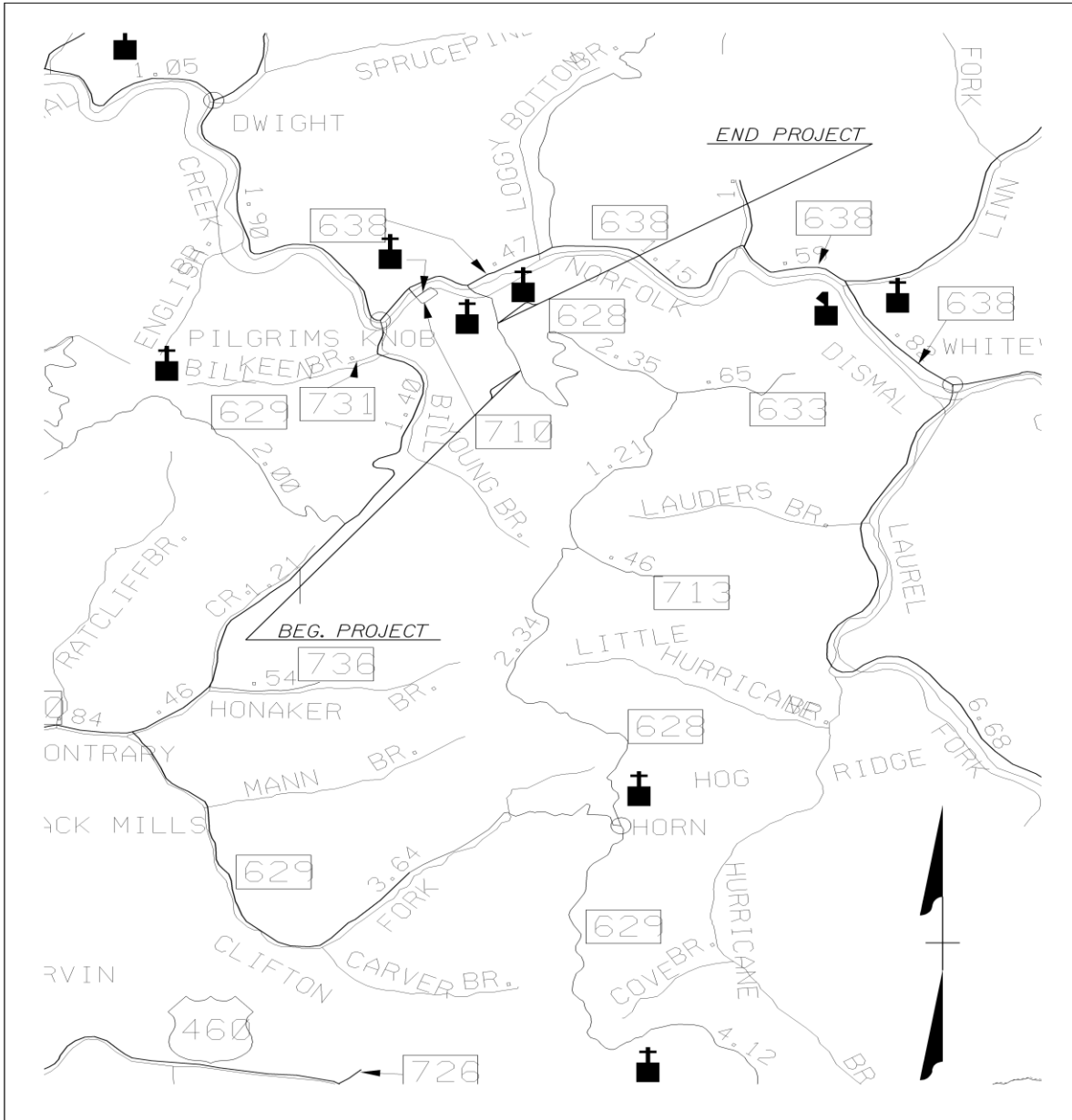

0628-013-P56, N501

ROUTE 628, BUCHANAN COUNTY\*

\* Rev. 1/07

# TYPICAL SECTION

## 0628-013-P56, N501

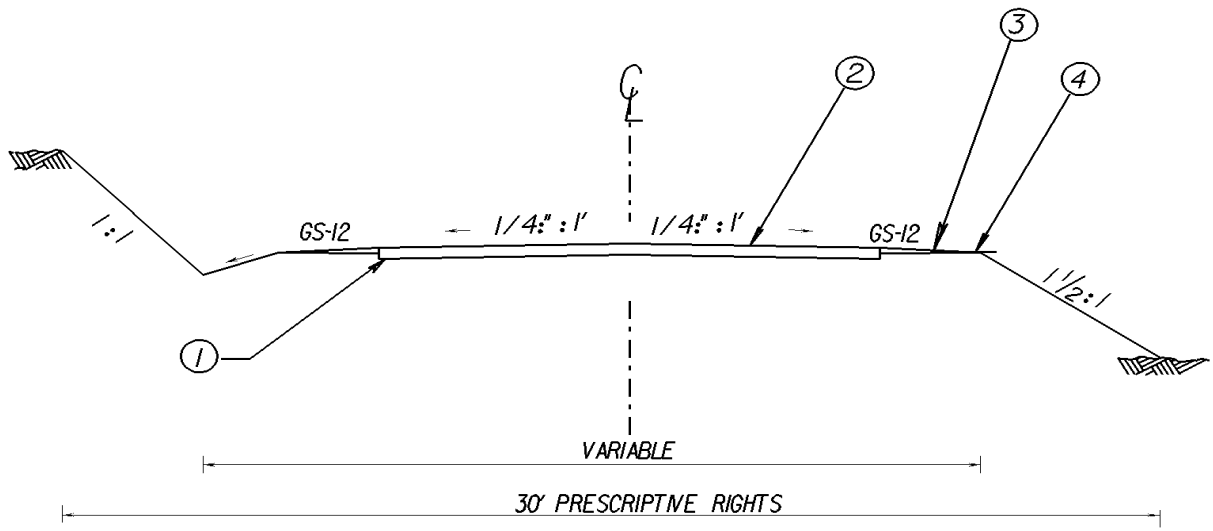

**\* R/W WITH EASEMENTS FOR CUTS AND FILLS**

NOT TO SCALE

- ① 6" DEPTH AGGR. BASE MATL. TY. 1 NO. 21B
- ② 4" DEPTH ASPHALT CONC. TY. BM-25.0
- ③ ASPHALT CONCRETE TY. SM-19.0 A AT RATE OF 200 LBS. SQ. YD.
- ④ STABILIZE SHOULDERS WITH 2" OF AGGR. BASE MATL. TY. 1 NO. 21B FOR ENTIRE WIDTH OF SHOULDERS

*Note: Depth to be placed as directed by the Engineer.*

**R/W WITH EASEMENTS FOR CUTS AND FILLS**

*6" Depth to be used for Estimating Purposes ONLY.*

**\*Increase shoulder width to 5' where guardrail is required.\***

**ROADSIDE DEVELOPMENT**

**CORE MIX**

MIX	LBS./ACRES	DESCRIPTION
1	100	* 100% CERTIFIED FINE FESCUE
2	100	100% CERTIFIED TALL FESCUE
3		50% CERTIFIED TALL FESCUE * 50% CERTIFIED FINE FESCUE
4		50% ORCHARD GRASS 50% CERTIFIED KENTUCKY BLUEGRASS
5		100% BERMUDA GRASS
TEMPORARY		
3/1 - 5/16 and 8/16 - 3/1		50% CERTIFIED TALL FESCUE 50%, BARLEY, WINTER RYE OR WINTER WHEAT
5/16 - 8/16		50% FOXTAIL MILLET 50% CERTIFIED TALL FESCUE

**ADDITIVES**

TYPE	LBS./ACRES	DESCRIPTION
A		100% LOVE GRASS
B	20	100% BARLEY, WINTER RYE OR WINTERWHEAT
C	10	100% FOXTAIL MILLET
D	10	100% ANNUAL RYEGRASS
E	20	100% CROWNVETCH (LEGUME)
F		100% SERICEA LESPEDEZA (LEGUME)
G		100 % BIRDSFOOT TREFOIL (LEGUME)
H		100 % Perennial Ryegrass
I	10	White Clover
J		
K		

ALL RATES TO BE SPECIFIED BY THE DISTRICT  
ROADSIDE MANAGER.

\* FINE FESCUES INCLUDE CHEWINGS, CREEPING RED,  
HARD, SHEEP

**SEEDING SCHEDULE**

SLOPES SEED MIX WITH ADDITIVE	MOWED SEED MIX WITH ADDITIVE	SLOPES SEED MIX WITH ADDITIVE	MOWED SEED MIX WITH ADDITIVE	SLOPES SEED MIX WITH ADDITIVE	MOWED SEED MIX WITH ADDITIVE
SPRING MONTH & DATE		SUMMER MONTH & DATE		FALL & WINTER MONTH & DATE	
Coastal	3/1 - 5/15	Coastal	5/16 - 9/15	Coastal	9/16 - 11/15
Piedmont	3/16 - 5/31	Piedmont	6/1 - 9/15	Piedmont	9/16 - 10/31
Mountain	3/16 - 5/31	Mountain	6/1 - 9/15	Mountain	9/16 - 10/31

PROJECT NUMBERS	2DI	1D	2CDI	1DC	2BI	1B
*SPECIFY KIND OF FINE FESCUE		HARD		HARD		HARD

**MIX REQUIREMENT THIS PROJECT**

RECOMMENDATIONS FOR THE APPLICATION OF SEED MIXTURES(CORE MIX AND ADDITIVES),  
FERTILIZER, LIME, ETC. ARE TO BE OBTAINED FROM THE DISTRICT ROADSIDE MANAGER.

## Erosion & Sediment Control

[See Drainage Manual, Chapter 10](#)

## SECTION OF SEED LOCATION

### NOTES:

Approximately 2 acres will be disturbed on this project and will require the establishment of grasses and /or legumes.



### NOTES FOR FIELD USE ONLY

Over seeding rates shall be equal to the normal seeding quantity for permanent seeding\* without fertilizer.

The Engineer will require the Contractor to perform supplemental seeding when less than 75 percent uniform stand of the permanent grass specified in the mixtures is obtained. (Annual species such as, Rye and Millet are temporary varieties and require supplemental seeding.)

### NOTES APPLY TO SCHEDULE

Legume seed mixes (Birdsfoot Trefoil, Crown Vetch and Sericea Lespedeza) and Weeping Lovegrass shall not be used on shoulders and other locations flatter than 3:1 slope.

Legume Seed shall be inoculated with the appropriate strain and rate of bacteria. When hydroseeding, use five times the amount of the inoculate recommended by the manufacturer.

A temporary mix of erosion control mulch, as directed by the Engineer, is to be used only on areas that are to be regraded or later disturbed, if left dormant for more than 15 days.

The appropriate Erosion Control Mulch, as directed by the Engineer, is to be used on areas that are to be left dormant for more than 15 days between December 1 and February 28.

The appropriate Erosion Control Mulch, as listed on the VDOT Approved Products List, shall be applied in accordance with the manufacturer's recommendations.

The appropriate Erosion Control Mulch shall provide 100% coverage of all denuded areas.

Spring & Summer and Fall & Winter defined for the purpose of determining whether hulled or unhulled Bermudagrass and Sericea Lespedeza seed is required:

Spring & Summer – 4/1 – 9/15 – use hulled seed  
Fall & Winter – 9/15 – 4/1 – use unhulled seed

Type I mulch (Straw) to be used on newly seeded areas adjacent to all waterways, wetlands, swamps, or any area in which drainage flows toward areas under the jurisdiction of the environmental regulatory agencies.

Type I mulch shall be applied to provide a minimum 90% coverage.

Type I mulch shall be tacked with Fiber mulch at the rate of 750 lbs. per acre.

Type II mulch (Fiber mulch) may be substituted for Type I mulch at the recommendation of the District Roadside Manager.

Type II mulch shall be applied at a rate of 2500 lbs. (net dry weight) per acre to provide a minimum of 90 percent coverage, and shall be applied in a separate application.

All topsoil is to be free of hard lumps, clods, rocks and foreign debris and is to be hand raked to tie into existing lawns.

All seed must be in conformance with VDOT seed specifications for Grasses & Legumes and be provided at the project site in bags not opened and labeled for use on VDOT projects with a green tag certifying inspection by the Virginia Crop Improvement Association.

## **SECTION A-8-SEQUENCE OF CONSTRUCTION/ TRANSPORTATION MANAGEMENT PLANS (TMP)**

### **INTRODUCTION**

Transportation Management Plans (TMP) are required on all Type A, B and C\* projects. TMP's consist of the following strategies (or plans): Temporary Traffic Control, Public Communication and Transportation Operations. Refer to [IIM-LD-241](#) for guidance.

These guidelines serve as a tool to assist the designer in plan preparation. Sequence of construction, temporary traffic control plans and constructability are related topics and significantly affect the quality of our plans. Broad issues of constructability and quality control are commented on; however they are not the focus of these guidelines. The purpose is to familiarize individuals with the technique and importance of preparing an adequate sequence of construction and temporary traffic control plans. Constructability issues concerning sequence of construction and temporary traffic control plans are covered. Reference material is located elsewhere in this section and in the Instructional and Informational Memoranda ([IIM-LD -241](#)). References listed at the end of these guidelines provide additional resources and the list of items to consider may serve as a checklist.

As related issues, the sequence of construction and temporary traffic control plans are included in one plan. The plan includes diagrams and appropriate notes to inform the contractor of when each operation is to be accomplished. The plan delineates traffic control procedures necessary prior to, during and following construction. The sequence is to be a guide with a step by step procedure from the beginning to the end of construction. It is important to provide the plan in a clear and easy to follow manner. Do not sacrifice plan clarity to reduce pages. The plan is necessary to insure that a project can be built as designed without undue difficulty and with minimum work orders. Developing a sequence of construction and temporary traffic control plans is an essential part of the overall project design and may affect the design of the facility itself. Design of the proposed improvements should be coordinated with the temporary traffic control plans. There may be acceptable design alternatives which would improve tie-ins to existing pavement and facilitate significantly smoother flowing sequence of construction and temporary traffic control plans.

A plan is necessary for complex projects when construction warrants a step by step explanation of the construction process. Such projects may have high traffic volumes, peak hour traffic backups, major cuts and fills, major drainage structures, bridges, or utility relocations requiring traffic detours or shifts. Begin planning in the very early stage of design and continue to solicit assistance throughout the design process to finalize the plan. Request input at Field Inspection and other appropriate meetings as necessary.

---

\* Rev.1/09

Throughout the design process it is important to keep in view the big picture. Before beginning to prepare a sequence of construction plan, walk or drive the project to become familiar with the project and critical construction areas. Take notes, make sketches, video tape and take pictures to assist in communicating issues to consider.

Develop a draft sequence of construction plan, thinking through each step as it relates to the other steps. These guidelines contain some helpful suggestions and references. Reviewing examples of well prepared sequence of construction plans is an excellent way to learn about the various issues. Brain storm alternative construction sequences to arrive at the most practical. It may be helpful to color code each phase of construction and make a written narrative of each phase.

Seek advice from individuals, sections or other divisions with particular expertise or experience necessary in preparing sequence of construction plans. Methods of obtaining advice include requesting individuals to review a sequence plan or setting up a meeting to discuss concerns and alternative solutions. There is a wealth of knowledgeable and experienced individuals within VDOT to consult when preparing sequence of construction and temporary traffic control plans.

The road designer should consult and coordinate input from the Scheduling and Contract, Environmental, Asset Management, Materials, Right of Way, Structure and Bridge, Traffic Engineering, and Local Assistance Divisions, the Project Engineer and Inspector throughout the process of developing a sequence of construction and temporary traffic control plans. It may be appropriate to contact the District and Central Office representatives of referenced Divisions, particularly the responsible District\* Traffic Engineer. Advantage should be taken of all opportunities to solicit public input concerning the planned sequence of construction and temporary traffic control plans. The public commutes the subject area every day and is in a position to point out situations of concern. Evolution of a sequence of construction and temporary traffic control plans is an ongoing process and modifications will be necessary prior to and during construction as issues surface or difficulties develop.

The road designer is responsible for preparation of the plan for inclusion in the plan assembly. Preparation will involve requesting, coordinating and organizing input from numerous other individuals. The designer is not expected to know all of the traffic control options and construction techniques and other related expertise necessary to prepare a comprehensive plan. The plan should be located in the front portion of the plan assembly, within the 1 series of sheets.

The Location and Design policy concerning sequence of construction and temporary traffic control plans is as follows:

Preliminary Temporary Traffic Control Plans/Sequence of Construction Plans are to be developed by the roadway designer in the earliest possible stage of plan development and reviewed by the responsible District Traffic Engineer prior to Field Inspection.

---

\* Rev. 1/17



Temporary Traffic Control Plans/Sequence of Construction Plans should safely and efficiently maintain traffic while providing capacity and operating speed comparable to the typical highway conditions where feasible.

The following note is to be shown on the Temporary Traffic Control Plans/Sequence of Construction Plan:

"Unless otherwise approved or directed by the Engineer, the Contractor shall plan and prosecute the work in accordance with the following:"

The responsible District\* Traffic Engineer will determine locations where detailed plans for traffic control devices are required for inclusion in the final Temporary Traffic Control Plans /Sequence of Construction Plan.

Following the Field Inspection, plans are revised to incorporate the District Engineer/Administrator's Field Inspection recommendations, and the electronic files are updated and will be provided to the responsible District Traffic Engineer. The responsible District Traffic Engineer will provide recommendations to the roadway designer to prepare the necessary traffic control devices for inclusion in the construction plan assembly.

The Temporary Traffic Control Plans/Sequence of Construction Plans are reviewed as follows:

1. Quality Review for Field Inspection
2. Field Inspection
  - a. Recommendations from the District Engineer/Administrator at Field Inspection are submitted to the Project Manager.
  - b. After accepted Field Inspection recommendations have been incorporated into the plans, prints are provided to the responsible District Traffic Engineer and State Traffic Engineer for review prior to Public Hearing/Right of Way Stage.
  - c. Detours, right of way, and easements must be completed in sufficient detail for the right of way requirements to be incorporated into Public Hearing/Right of Way plans.
3. Right of Way and Constructability Review
4. Advertisement Quality Review
5. Pre-advertisement meeting

---

\* Rev. 1/17

## SEQUENCE OF CONSTRUCTION

A sequence of construction plan is to include diagrams and appropriate notes to inform the contractor of when each operation may be accomplished and advise of traffic control necessary during construction.

Except for the most simple projects, a sequence of construction is necessary. Delays and redesign during construction are often extremely costly, may also cause an unsafe situation and can unnecessarily cause additional disruption of traffic patterns. Our desire is to minimize the inconvenience to the public. To the extent possible, the plan should have flexibility. Recognize that the contractor may, with the Engineer's approval, modify the sequence of construction, but to approach a project without a plan is risky. The sequence may seem simple at first glance but thinking through the steps helps make us aware of possible difficulties. Each project presents unique challenges and developing a sequence of construction offers opportunities to address these concerns at an early stage.

The road designer is responsible for determining the need for barricades and detours during construction. The designer is also to review the plans carefully to determine if it will be necessary to shift traffic lanes away from the normal position during construction and determine required easements. If shifting lanes is necessary, a sequence of construction is to be prepared by the designer with input from the appropriate Assistant Scheduling and Contract Engineers and/or Assistant District Engineer. The sequence of construction plan is to be reviewed by District office representatives and individuals from applicable divisions and agencies at each stage of plan development. The Scheduling and Contract, Environmental, Asset Management, Materials, Right of Way, Structure and Bridge, Traffic Engineering, and Local Assistance Divisions, Project Engineer and Inspector should be consulted concerning their respective areas of responsibility.

When a Sequence of Construction Plan is necessary, it will be included in the plans that are distributed for review at the Field Inspection and it will be of sufficient detail to present the basic concept for discussion and determination of environmental, traffic, safety, and right-of-way requirements. Reviewing examples of well prepared sequences of construction plans is an excellent way to learn about the various issues to be addressed. Examples should address different construction challenges. Discussion should take place at the Field Inspection concerning a narrative if a Sequence of Construction Plan is not necessary. All of the above items are to be discussed thoroughly at the Field Inspection and recommendations included in the Field Inspection Report. \*

---

\* Rev. 7/06

A copy of the sequence of construction plan, with the accepted Preliminary Field Inspection recommendations incorporated, is to be furnished to the Traffic Engineer prior to the Field Inspection/Right of Way stage. If detours, right of way or easements are required for the temporary traffic control plans\*, the sequence of construction must be completed in sufficient detail for the right of way requirements to be incorporated into the Field Inspection /Right of Way plans.

When a sequence of construction plan or narrative is unnecessary for a particular project, the file will be documented accordingly with the listing of the names of those involved in the decision and the reasons for the decision. The field inspection prints must also indicate that a sequence of construction plan or narrative is not necessary and that only such items as flagging, warning lights, etc., will be required.

### **ITEMS TO ADDRESS UNDER SEQUENCE OF CONSTRUCTION:**

Adjoining projects and sequence of construction must be coordinated. There may be occasions where a portion of one project would be more efficiently constructed at a designated stage of the construction sequence of another project. This may apply at intersections or other locations. Surplus material may be utilized from an adjoining project. Section 105 of the [Road and Bridge Specifications](#) specifies that there shall be cooperation among contractors on adjoining projects.

Bridge construction should be addressed in the sequence of construction. The coordination of the bridge construction with the roadway portion should be evaluated relative to connecting temporary bridge parapet with the traffic barrier service to insure the proper tie when performing the installations. Bridge construction often requires very large cranes and other large equipment and materials. It is desirable to avoid constructing a bridge in sections. Also avoid setting beams over traffic. Input should be furnished by the Structure and Bridge, Scheduling and Contract and Traffic Engineering Divisions to provide a plan taking these issues into account. Detours may be necessary during periods of bridge construction.

Construction activity: Sequences of construction should be designed to prevent worker activity left and right of traffic at the same time. This situation makes the driver feel restricted, slows traffic and endangers workers. Construction normally takes place on the outside portion of the project and moves in (on major widening or reconstruction projects). Weather and other factors impact the length of construction time. Weather may affect concrete pavement and other concrete construction.

Drainage: Temporary ditches or pipes may be necessary. Replacement of existing drainage may require a temporary diversion ditch or pipe. Jacking versus open cut for pipe causes less interruption to traffic but is normally a considerably more expensive method of pipe installation.

---

\* Rev. 7/08

Proposed pipes under roadways with high traffic volumes or difficult detours options are candidates for jacking. New construction and extensions of box culverts require considerable construction time. Urban projects should incorporate precast drainage items as much as practical, since improvements in urban areas are generally adjacent to and performed under traffic. Precast items would reduce worker exposure time to traffic and vice-versa since a precast item can be installed much quicker than a cast in place item. Openings for cross-drain pipes on interstates should be designed to prevent small children and animals from accessing the freeway.

Environmental concerns include avoiding wet lands and seeding disturbed slopes at the earliest appropriate stage of construction.

Excavation and earthwork: The Grading Summary and material hauls must match maintenance of traffic and sequence of construction plans. Consider borrow material versus surplus material at each stage of the sequence. Address locations where surplus material may be placed. Areas of graded slopes may be appropriate locations to waste surplus material. Consider areas of major cut or fill to anticipate slope tie in difficulties. In development of the Grading Diagram and Summary, it is essential that the project sequence of construction be taken into consideration to avoid specifying use of material which is not available in the appropriate phase of construction. On complex projects, it may be necessary for the designer to develop rough grading diagrams and summaries for each phase of work to accurately determine the grading effort required.

Example plans: Review example plans and seek advice from individuals with experience.

Funeral homes and Churches: Construction should be prohibited in the immediate vicinity of funeral homes and churches during services. This is common courtesy and enhances public relations. This consideration will normally be addressed during preconstruction meetings, but may warrant a plan note.

Intersection reconstruction may require a Sequence of Construction/Temporary Traffic Control Plans\* as these areas may be very involved.

Material hauls: The contractor should plan the transfer of materials and equipment in a manner that minimizes the impact on traffic movement, as much as practical.

Nighttime construction: In order to reduce the disruption of traffic flow and avoid stopping traffic, certain construction activities, such as the placement of bridge beams or overhead sign structures should be accomplished at night. However, additional safety precautions may be necessary when accomplishing this activity.

---

\* Rev. 7/08

Note in the plans that the Contractor shall plan and execute the work in accordance with the Sequence of Construction Plan unless a change is approved or directed by the Engineer.

Note in the plans that it is not the intent of the sequence of construction plan to enumerate every detail which must be considered in the construction of each stage, but only to show the general handling of traffic.

Pavement or structure demolition sequence should be considered.

Railroad crossings or construction adjacent to rail lines should be considered. Input should be obtained from the Virginia Department of Rail and Public Transportation concerning special requirements. Avoid situations where traffic signals, road intersections, road grades and etc. could trap vehicles on the tracks.

Sound barrier walls: The sequence of constructing sound barriers should be closely reviewed, especially when located on the shoulder, since access for work vehicles may require a lane closure. Consideration should be given to sound barrier construction at an early stage of the project construction to help shield adjacent areas from noise.

Time of day, holidays or other day and time restrictions may be necessary stating when construction or traffic flow restraints are not allowed. Notes may be necessary stating specific dates/times. Local ordinances such as noise may restrict when work can be performed. Section 105 of the [Road and Bridge Specifications](#) specifies restricts Holiday work times unless permission is granted by the Engineer.

Utilities: On some projects utility relocations are complete prior to beginning the road construction. Existing utilities should be addressed in the sequence of construction as to when and by whom they will be relocated. A portion of the road construction may be necessary prior to installing or relocating utilities.

Walk or drive the project: Take pictures, notes, video and make sketches. This process will help in recalling and conveying to others the areas of concern.

### **TEMPORARY TRAFFIC CONTROL PLANS\***

A temporary traffic control plan is necessary to insure that motorists, pedestrians and construction workers can safely travel or perform their jobs during roadway construction. A well-thought-out and carefully developed plan will contribute significantly to the safe and expeditious flow of traffic as well as the safety of the construction forces. The goal of any maintenance of traffic plan should be to safely route vehicle, bicycle, worker and pedestrian traffic, including persons with disabilities, through or around construction areas.

---

\* Rev. 7/08

Geometrics and traffic control devices should operate in a manner comparable to the existing operating situation while providing room for the contractor to work effectively. A temporary traffic control plan informs the contractor in writing as to how we expect the traffic to be maintained throughout the project and how the summaries have been worked up. The plan may constitute a traffic maintenance sequence and include drawings and diagrams to convey instructions. Traffic flow arrows are recommended.

It is advantageous to prepare and evaluate the temporary traffic control plans from the motorist's point of view. We have all been delayed in traffic due to road construction. Many times it is unavoidable. Preparing an efficient temporary traffic control plan is one way we can better serve the public. It has been said that the shortest distance between two points is always under construction. This may be the public's perception when they are inconvenienced. Imagine how a driver would view the plan in operation.

Realize that there may be an element of surprise or uncertainty for the driver, who will likely be unfamiliar with the revised traffic pattern and hazards. The temporary traffic control plans must be coordinated with the sequence of construction. Reviewing examples of well prepared maintenance of traffic plans is an excellent way to learn about the various issues to be addressed. The examples should address different construction challenges. Do not hesitate to seek advice from Divisions, sections or individuals with expertise or experience in preparing a temporary traffic control plan, particularly the \*responsible District Traffic Engineer.

Maintaining a safe flow of traffic during construction must be carefully planned and executed. Although it is often better to provide detours, frequently it will be necessary to maintain the flow of traffic through the construction area. Construction areas are protected by barriers, appropriate speed limits, channelizing devices, signs, signals, lighting, impact attenuators, truck mounted crash cushions and flagging to provide safe traffic control during construction. Construction area devices may include variable message signs or divided highways. Sometimes it will also be necessary to encroach on the through-traffic lanes or shift lanes entirely in order that the construction can be undertaken. When this is necessary, designs for traffic maintenance should produce as minimal an effect as possible on normal traffic flow. The plan depends on the nature and scope of the improvement, volumes of traffic, highway or street pattern, and capacities of available highways or streets. The plan should have some built-in flexibility to accommodate unforeseen changes in work schedule, delays, or traffic patterns.

Adequate advance warning and sufficient follow-up information are needed for the motorist. Standards for the use and application of signs and other traffic control devices when highway construction occurs are set forth in Part VI of the Federal Highway Administration's [\*Manual on Uniform Traffic Control Devices\*](#), MUTCD. Designs for the use and application of signs and other traffic control devices are developed by the Traffic Engineering Division of VDOT. Traffic control devices instructions published by the Traffic Engineering Division are included in [\*The Virginia Supplement to the Manual on Uniform Traffic Control Devices\*](#).

---

\* Rev. 1/17

Part VI of the Virginia Supplement was modified and reproduced as a separate publication, [Virginia Work Area Protection Manual](#). Location and Design is responsible for the design of the facilities (except bridges) to accommodate the traffic.

The stopping of public traffic by a flagger or any other means should be avoided where possible and should be approved by the District \*Engineer/Administrator. Designs that provide for constant movement around an obstruction in the roadway, even if it is slow, are more acceptable and are less irritating to drivers than requiring them to stop. Construction operations frequently create the need for adjustments in traffic patterns including the shifting of lanes.

Splitting traffic in the same direction on both sides of construction is not acceptable. The minimum taper length for lane transitions in construction areas can be computed by a formula found in the MUTCD. Various configurations are illustrated in the MUTCD and should be used in developing temporary traffic control plans.

Designed shifts in traffic flows are to conform to the geometrics shown in the standards for detours (Standard GS-10) and/or as indicated in the "Safety Guidelines for Construction Zones" (See [IIM-LD-93](#)).

Depending on various project conditions, the Traffic Engineering Division may recommend one of the following methods of maintaining traffic for a project.

A. Under the following circumstances a simple sequence would normally be used:

1. If the Average Daily Traffic volume (ADT) is 1000 or less.
2. If there are no pipes that are 48" or greater in diameter.
3. If there are no double lines of 24" pipe or greater.
4. If there are no major drainage structures.
5. If no major off-site detours are required.
6. If there are no major utility relocations required.

A simple sequence may read:

"Traffic is to be maintained throughout the project on the present road or on the grade where the present road is to be raised or lowered. Short periods of one-way, flag controlled traffic may be allowed at the option of the Engineer."

B. Under the following conditions a simple sequence requiring time restrictions should be considered, but keep in mind that these are only meant to be used as general guidelines. Time restrictions may not be necessary in all of the following situations:

---

\* Rev. 7/15

1. If the ADT is 1000 or more and could present a problem with peak-hour traffic backup;
2. If there are pipes larger than 48" in diameter;
3. If there are double lines of 24" pipe or larger.
4. If there are major drainage structures.

A simple sequence with "time" restrictions may read:

"Traffic is to be maintained throughout the project on the present road or on the grade where the present road is to be raised or lowered with a minimum lane width of \_\_\_\_\_. Two-way traffic is to be maintained between the hours of \_\_\_\_\_:\_\_\_\_\_ a.m. to \_\_\_\_\_:\_\_\_\_\_ p.m. weekdays, and at all times on Saturdays, Sundays and Holidays, unless otherwise directed by the Engineer."

- C. A more in depth sequence or an off-site detour may be required in situations where neither of the simple sequences listed above are appropriate. This may require a step by step description of the sequence.

When construction operations are scheduled to take place adjacent to passing traffic, a clear zone should be called for in the plans between the work and the passing traffic. Under most conditions, positive barriers or time restrictions are justified.

#### **ITEMS TO BE ADDRESSED UNDER MAINTENANCE OF TRAFFIC INCLUDE:**

Access to adjacent residential and commercial properties should be maintained at all times. Temporary traffic control plans and sequence of construction notes should reflect this policy and emphasize the requirement at fire stations, emergency rooms and other emergency facilities. Section 104 of the [Road and Bridge Specifications](#) specifies that entrances shall be maintained.

Asphalt medians: Temporary medians should be considered where construction creates situations with new traffic patterns for motorists. This channelizing will provide improved safety by forming a positive separation of opposing traffic.

**Concrete**\* Barrier, attenuator service and truck mounted attenuator guidelines and standards are contained in the Construction Zone Safety IIM-LD-93. [Standards/Special Design Section](#) will be contacted to design the Impact Attenuators. The location of drums, barriers, or barricades, as means of channelizing traffic, shall be detailed in the temporary traffic control plans when special conditions exist. **Concrete barrier and Channelizing devices requirements** are addressed in the [Virginia Work Area Protection Manual](#). Concrete barrier placement is important. There will be instances when construction access in runs of traffic barrier service will be necessary for the contractor to access materials and equipment. These locations should be reviewed to determine if attenuators or a transition is needed. Runs of traffic barrier should be properly transitioned on either end, in the clear zone, as indicated in the [Virginia Work Area Protection Manual](#), for the operating speed during construction. **For additional information see Appendix I.**

---

\* Rev. 11/15



Otherwise, temporary impact attenuators will be required. Applicability of Quickset Barrier System; use of Quick Change barriers may facilitate changing the number of lanes during rush hour. There may be times when it is practical to implement the Quick-change Traffic Barrier System to maintain roadway capacity in the AM and PM peak hours, yet provide additional work space for specific work activities during off-peak times. The NEAT attenuator system is an end treatment for temporary work zones which has FHWA approval for use on these barrier systems.

Bridges; Temporary bridges may be cost effective for reconstruction of existing bridges.

Bridge rails, existing: In many instances, existing bridges do not have the accepted approach guardrail runs and terminal treatments. Due to the unusual and distracting work techniques used in bridge construction that may be in the immediate vicinity of traffic during the erection of the proposed structure, maintaining traffic on the existing structure may require guardrail, at least on the right side of approaching traffic to eliminate run off the road or fixed object impacts by an errant motorist.

Clear zone: Clear zone requirements should be maintained and the contractor should be instructed to maintain the clear zone free of stored materials and parked equipment as much as practical.

Construction equipment: Idle construction equipment must not impact sight distances at intersections and especially in school zones or entrances. When the construction site is in the vicinity of an airport, consideration should be given to include a note on the plans that the contractor shall be responsible to insure construction equipment does not violate Federal or airport clearance regulations.

Coordinate work: There may be times that several contractors are working in the same vicinity. During these times advanced work zone signing should be coordinated to insure driver expectancy is not compromised by the placement of unnecessary or conflicting signing.

Detours may be necessary to provide the smoothest and safest traffic flow around work zones. If a temporary detour is shown in the temporary\* traffic control plans, it should be graphically indicated in the plan assembly, with the proper directional advanced signing for the contractors guidance prior to initiating work activities. Address issues of alignment, grade, length, width, pavement strength, truck restrictions, detour capacity for rerouting traffic, detour quantities (including grading, drainage, pavement, etc.) and a detour removal detail (with pay items). Temporary detour grades are necessary where such grades are not obvious such as paralleling existing pavement. When shoulders are used as a detour, the pavement width and strength should be reviewed to accommodate the appropriate vehicle loads.

---

\* Rev. 7/08

Detour operating speed should approximate existing highway operating speed (every attempt should be made to not reduce the speed by more than 10 mph). Attention should be given to maintaining emergency (fire, etc.) vehicle, bus and mail routes. It may be appropriate to request District input, research or communication with the fire department, school authorities and other authorities concerning the maintenance of traffic patterns. Include traffic items provided by the \*responsible District Traffic Engineer.

Edgeline markings: A one foot offset should be provided between the face of traffic barriers and the edgeline marking. This provides some lateral distance for distracted or crowded drivers to maneuver if needed.

Emergency access: During construction of roadway improvements and especially one lane maintenance projects and bridge projects, construction and flagger crews should be alert to the access needs of fire, rescue and police vehicles in the vicinity. Safety of the workers and public on the project and elsewhere is of primary importance.

Glare screens: Consideration should be given to using glare screens where practical, and when sight distances will not impact merging motorists. Glare screens reduce motorists distractions to worker activity behind the traffic barrier service and may result in a better quality product since workers would not be distracted by traffic.

Also, reducing distractions will enhance safety, improve traffic flow and decrease rubber-necking.

Grades are important to consider when establishing temporary traffic control plans. Vertical and horizontal alignment must be considered. Design alternatives for the vertical and horizontal alignment of the proposed improvements should consider the temporary traffic control plans. There may be acceptable design alternatives which would improve tie-ins to existing pavement and facilitate a significantly smoother flowing sequence of construction and temporary traffic control plans. Detours, material haul roads, temporary access locations and road connections must be vertically and horizontally evaluated. Also, insure that required construction fill will not encroach on existing travel way and maintained traffic while constructing deep cuts and high fills. When sheet piling is necessary, it requires subsurface investigation.

Grading diagram coordination is important with the temporary traffic control plans. Plan the traffic plan to facilitate implementation of the grading diagram.

Highway advisory radio: Interstate improvements may warrant the need for highway advisory radio broadcast, to provide advanced warning to motorists that delays should be expected unless the suggested alternate route is used.

---

\* Rev. 1/17

Impact attenuators: These are required at the introductory locations of traffic barrier service, unless the traffic barrier can be transitioned as indicated in the Virginia Work Area Protection Manual. [Standards/Special Design Section](#)\* will be contacted to design the Impact Attenuators.

Lane closures: When lane closures are proposed in the traffic control and sequence of construction plan, the use of electronic arrow boards and variable message signs should be addressed. This subject is normally addressed at Field Inspection by the Traffic Engineer.

Lanes, number of: While it may not always be possible to provide the same number of lanes that were available prior to initiating construction activities, the same number of lanes should be provided during peak hours. Lane restrictions may not be appropriate during certain periods and this should be noted on the plan.

Lane shifting: Lane shifting should be designed to accommodate the operating speed for the particular work zone. When these areas are on 4 lane divided facilities and the operating speed is considerably high, the proper superelevation is imperative. Also, the adequate horizontal and vertical alignment must be available to maintain driver expectancy and should not be designed for more than a 10 mph speed reduction than that of the remainder of the work zone.

Lane widths: Adequate lane widths should be available. Geometric Design Standards in the front of Appendix A of the *Road Design Manual* specify lane widths. Lane widths should be a minimum of 11' and in minor work zones 10'. When determining lane widths, the percent of truck traffic should be considered.

Navigable streams: Advanced up and down stream signing should be provided for sportsmen, canoeist and fishermen when overhead construction activities are required for bridge placement over navigable streams.

Pavement design should incorporate existing pavement when practical. Pavement design should consider temporary markings, so proper courses may be specified at appropriate construction stages. Milling may excessively weaken existing road pavement strength, such as at bridge approaches and the Materials Division should be consulted for appropriate instructions.

Pavement markings for temporary use may be covered with the final pavement course. Details should provide for any special pavement marking requirements. Pavement marking eradication information is in [IIM LD-93](#). Temporary pavement markers should be considered to provide more positive guidance at nighttime and during inclement weather.

---

\* Rev. 7/07

Pavement surface within the construction and detour areas should be maintained in a condition that will permit the safe movement of traffic at a reasonable speed.

Peak traffic hour work: The temporary traffic control plans\* should direct the contractor not to perform work which would impede the flow of traffic during peak hours of traffic congestion, holidays, etc.

Pedestrian traffic must be maintained. The temporary traffic control plans should accommodate pedestrian traffic as well as automobile traffic, particularly in urban areas.

Phases: Engineering studies indicate work zone lengths should not exceed 0.5 mile in length. Research in work zones indicates an increase in accident rates when motorists are subjected to extended travel times adjacent to work zone activities. Consideration should be given to constructing the facility in phases containing 0.5 mile work zone lengths, where practical. There may be situations with minimal driver distractions and inconvenience where a work zone should be as much as two miles in length.

Railway crossings must be considered. Avoid designs where traffic signals, road intersections, road grades and etc. could trap vehicles on the tracks. This was also mentioned under sequence of construction.

Right of way or temporary construction easements may be required for construction or temporary detours: Sheet piling may be more economical in some situations.

Safety issues are always of paramount importance. They encompass more items when maintaining traffic through a construction site because safety of the workers is an additional element. The worker is often protected only by the barriers or other features of the temporary traffic control plans.

Shoulders: In relatively long work zone areas, the construction of an adequate shoulder is desirable, to provide lateral placement of stalled or disabled vehicles beyond the travel lanes.

Sight distance: Adequate vertical and horizontal sight distance must be maintained for safety reasons.

Signalization, temporary and permanent: Existing and proposed pole locations must be taken into account. Signal timing: When construction activities, such as resurfacing, require the closure of an existing lane, it may be necessary to lengthen the green time for that leg. This would help retain the capacity of the intersection.

---

\* Rev. 7/08

The State Traffic Engineer is responsible for preparation of the sign, signal and lighting plans. Temporary traffic signalization may be required at some locations for construction purposes. They will require detailed plans, just as permanent signals.

Signs with variable messages: Due to terrain or inclement weather, the use of passive signing may not be enough to maintain the desired element of safety. It may be appropriate to install variable message signs to attract the driver's attention when approaching a changing traffic pattern.

State police: There may be certain roadway improvements where the worker is adjacent to motorists and there is a danger of automobile encroachment into the work area. These projects may require the participation of state police for the enforcement of posted speed limits within the work zone. See State Police Participation in [IIM-LD-93](#). Interstate roadway improvements may warrant an increase in the number of existing safety patrols to reduce delays and provide assistance to stranded motorists within the travel lanes.

Stubs should be designed where appropriate to facilitate improved temporary traffic control plans\* for future road extension. Pavement stubs and "tie-in" construction should be addressed in the maintenance of traffic plan.

Tapers are needed for lane drops or at locations where traffic must be shifted laterally. Appropriate values for taper lengths can be found in Part VI of the MUTCD.

Traffic volume capacity: Attempt to maintain the traffic volume capacity of existing roads.

Turn lanes should be maintain (left and right).

Utility adjustment must be accommodated.

Wrecker service: Some work zones, mainly on limited access facilities, may require the implementation of 24 hour wrecker availability for the towing of disabled vehicles.

---

\* Rev. 7/08

**NOTES WHICH MAY BE APPROPRIATE ON TEMPORARY TRAFFIC CONTROL AND SEQUENCE OF CONSTRUCTION PLANS INCLUDE:**

(These notes should be developed in coordination with the \*responsible District Traffic Engineer).

Unless otherwise approved or directed by the Engineer, the contractor shall plan and prosecute the work in accordance with the following sequence of construction and temporary traffic control plans and this shall be coordinated with the bridge plans.

It is not the intent of the sequence of construction plan to enumerate every detail which must be considered in the construction of each stage, but only to show the general handling of traffic.

All areas excavated below existing pavement surface and within the clear zone, at the conclusion of each workday, shall be back filled to form an approximate 6:1 wedge, against the existing pavement surface for the safety and protection of vehicular traffic. All cost for placing, maintaining and removing the 6:1 wedge shall be included in the price bid for other items in the contract and no additional compensation will be allowed.

Traffic barrier service shall be installed and removed so as not to present any blunt end or hazard to the motoring public. The placement and removal of the traffic barrier service and barricades are to be coordinated by the Project Safety Officer.

**LIMITATION OF OPERATION** notes may include:

The following restrictions will apply, except in cases where the Engineer determines they are not in the best interest of the Department and/or the traveling public.

Traffic shall not be detained on route \_\_\_\_\_ for longer than five minutes at any time, unless directed by the Engineer.

Closing of traffic lanes or shoulders is only permitted between 10:00 P.M. and 6:00 A.M. Monday through Friday.

No lane restrictions will be permitted from 12:00 Noon Friday until 9:00 A.M. Monday and during the following period: 6:00 A.M. Dec. 23, 2006 through 7:00 P.M. Jan. 3, 2007;

Note concerning southbound traffic may read: All travel lanes shall be open between the hours of 4:00 P.M. and 6:00 P.M. Monday through Friday. One travel lane may be closed all other times with the exception of dates listed below.

---

\* Rev. 1/17

## CONSTRUCTABILITY

Constructability relates to whether the project can be constructed as designed with the information shown in the plans. Many of the necessary items to consider when determining the constructability of a project are included in the Road Design Manual's Quality Control Checklist.

There is a huge advantage in having a construction expert review the concept of a project before even preliminary plans begin. A construction expert can review the proposed project and what it is intended to achieve, the proposed location of a project, the duration for design and construction and various design alternatives. This review should involve a dialogue with the design leaders of the project.

The construction expert will look at the proposed project through the eyes of the constructor and will consider the advantages and disadvantages of the potential design alternatives. There should be a review of the site and of the surrounding areas.

Geology, topography, accessibility, utilities, existing infrastructure, businesses, residences, etc., should be examined from the contractor's perspective. Potential strategies likely to be adopted by the contractors to deal with all these site issues should be discussed with the design team to see how the design might be developed to dovetail with strategies that are beneficial to the contractors and the local population in the prosecution of the project.

The review may go several miles beyond the environs of the project to examine access for large equipment.

There are issues that can impact design decisions and should be examine early. It provides the opportunity for the designer to begin design with certain key issues in mind which can frequently be accommodated in the design without adverse cost impact to the design. It is not that constructability issues drive the design but that design accommodates constructability in its evaluation. This is much better than trying to inject constructability into the design later.

The construction expert should have a broad knowledge of construction in several fields, not just highways and bridges, together with an understanding of, and empathy with, both the designer and the constructor. Constructability is more than simply making life easier for the contractor. It is the incorporation of construction expertise into the design process so that it will meet all of the design requirements, including aesthetics, at the lowest reasonable cost of construction.

Deleted Information\*

---

\* Rev. 7/06

A construction expert will have this broad expertise, together with the ability to work cooperatively and sympathetically with the design team and to respect the integrity of their design. In this way, the constructability review process becomes a team operation where the constructability resource and the design team work together cooperatively to integrate constructability into the design process.

#### **ITEMS TO BE ADDRESSED UNDER CONSTRUCTABILITY INCLUDE:**

Access to adjacent residential and commercial properties should be maintained at all times.

Contractor operations: Adequately evaluate and explain appropriate construction task and operations. This may include the order of construction activities.

Drainage issues: Drainage network errors have had the largest dollar impact and account for 25% of total errors on plans; last minute design changes to the roadway plans, which often require adjustments to the drainage plans, caused many of these errors. Check inverts of culverts and systems to insure positive drainage and outfall. Utility conflicts can significantly affect the sequence of construction. Address the need for temporary drainage for construct, detours, slope drains, etc. See VDOT's [Drainage Manual](#).\*

Easements and right of way must be sufficient to construct Project. Few issues can cause more construct delay than the lack of necessary easements or right of way.

Environmental issues: These are issues that can cause more construction delay or unexpected cost. Environmental Division representatives will provide guidance on these issues such as permits required for construction in live streams or concerning wetlands.

Equipment necessary such as piers, cranes, etc.: Adequate equipment clearance such as a crane swing radius is a constructability issue, for safety and functional reasons. Large equipment deserves special consideration as to how it will be transported to the job site and to provide adequate maneuvering clearance during construction. The Construction Division is a source for advice.

Excavation near existing structures: One issue may be a question of providing adequate horizontal distance to maintain the integrity of existing structures. A subsurface investigation may be appropriate for some locations. The Construction Division is a source for advice.

---

\* Rev. 7/16



Materials supply: Consider where and how materials may be supplied to the project. Consider what form of transportation may be utilized to transport material to the job site.

Picture how each aspect of the project will be constructed from the beginning as it would look in the field rather than from plan view.

Plan information: Provide comprehensive plan information for construction of the project.

Plan views, profiles and cross sections must agree.

Precast versus cast-in-place structures should be addressed when appropriate.

Quantity summaries must be complete.

Right of way and easements must be adequate to construct project, store material and operate equipment. Signing, lighting, signalization and other issues present possible needs for additional easements or right of way.

Utility conflicts and relocations can significantly affect project construction schedules.

## REFERENCES:

Guidance concerning sequence of construction, temporary traffic control plans\* and their impact on constructability are found in the following references:

### Road Design Manual:

1E-1	Quality Control and Checklist
2D-25	Pavement Termination
I-2	Traffic Barriers - Guardrail and Concrete Barriers
2E-79	Safety Items and Sequence of Construction
2G-21	Temporary Diversion

---

\* Rev. 7/08

Instructional and Informational Memoranda:

IIM-LD-93 Construction Zone Safety  
 IIM-LD-241 Work Zone Safety and Mobility

Road and Bridge Specifications:

Section 104, Scope of Work and Section 107, Legal Relations and Responsibility to the Public

The Federal Highway Administration's [Manual on Uniform Traffic Control Devices](#), MUTCD

[The Virginia Supplement to the Manual on Uniform Traffic Control Devices](#)

[The Virginia Work Area Protection Manual](#) replaces Part VI of the [Virginia Supplement to the Manual on Uniform Traffic Control Devices](#)

VDOT's [Drainage Manual](#)).

## SEQUENCE OF CONSTRUCTION AND TEMPORARY TRAFFIC CONTROL ITEMS TO CONSIDER

### A. SEQUENCE OF CONSTRUCTION

(Items to Consider)

- Adjoining projects
- Bridge construction
- Construction activity
- Drainage
- Environmental concerns
- Excavation and earthwork
- Example plans
- Funeral homes and Churches
- Intersection reconstruction
- Material hauls
- Nighttime construction
- Note in the plans
- Pavement demolition
- Railroad crossings
- Sound barrier walls
- Time of day, holidays or other time restrictions
- Utilities
- Walk the project; take notes, make sketches and take pictures and videos.

---

\* Rev. 7/16

**B . TEMPORARY TRAFFIC CONTROL \***

(Items to Consider)

Access to adjacent properties  
 Asphalt medians, temporary  
 Barrier and attenuator service  
 Bridge rails, existing  
 Clear zone  
 Construction equipment  
 Coordinate work  
 Detours  
 Edgeline markings  
 Emergency access  
 Glare screens  
 Grades  
 Grading diagram  
 Guardrail laps  
 Highway advisory radio  
 Impact attenuators  
 Lane closures  
 Lanes, number  
 Lane shifting  
 Lane widths  
 Navigable streams  
 Pavement design  
 Pavement markings  
 Pavement surface  
 (Items to Consider)  
 -continued- Peak traffic hour work  
 Pedestrian traffic  
 Phases  
 Railroad crossings  
 Right of way and easements  
 Safety issues  
 Shoulders  
 Sight distance  
 Signalization  
 Signs with variable messages  
 State police  
 Stubs  
 Tapers  
 Temporary grade separation  
 Traffic volume capacity  
 Turn lanes  
 Utility adjustment  
 Wrecker service

---

\* Rev. 7/08

**C. CONSTRUCTABILITY**

(Items to Consider)

Contractor operations  
Drainage  
Easements and right of way  
Environmental  
Equipment  
Excavation  
Materials  
Picture each aspect  
Plan  
Plan/profiles/cross sections agree  
Precast versus cast-in-place  
Quantity summaries  
Signing, lighting, signalization  
Utility conflicts