

APPENDIX F

Access Management Design Standards for Entrances and Intersections

PREFACE

The access management regulations and standards do not apply in cities, towns of more than 3,500 and in counties (Henrico and Arlington) that maintain their secondary roads (they do apply on primary routes in these two counties). Such localities, though, may choose to apply them to roads they maintain.

The 2007 General Assembly unanimously approved legislation ([Chapter 863](#)) proposed by the Governor to direct VDOT's commissioner to develop, solicit public input on, and publish access management regulations and standards by December 31, 2007 to become effective July 1, 2008. The legislative goals for access management are to:

- Reduce traffic congestion,
- Enhance public safety by decreasing traffic crash rates,
- Support economic development by promoting the efficient movement of people and goods,
- Reduce the need for new highways and road widening by maximizing the performance of the existing state highways, and
- Preserve the public investment in new highways.

To assure that a wide variety of viewpoints were considered, multiple techniques were used to gain public input on the draft regulations and standards. The commissioner approved and published the regulations and standards in December 2007.

Legislation was enacted during the 2008 General Assembly session to require that the regulations and standards be implemented in phases. The first phase allowed the access management regulations and standards for VDOT highways classified as principal arterials to take effect July 1, 2008.

During the second phase, the regulations and standards developed during 2007 for minor arterials, collectors, and local streets underwent an extensive public review in accordance with the Administrative Process Act. These regulations and standards became effective on October 14, 2009.

This Appendix, therefore, contains the standards for the design of intersections, turning lanes, and entrances and for the spacing of entrances, intersections, traffic signals, median openings and crossovers that apply to all state highways: principal arterials, minor arterials, collectors, and local streets. If a design standard cannot be met a design exception or waiver is required. If a spacing standard cannot be met, a spacing exception is required. For more information, see "Exceptions to the Spacing Standards" and "Exceptions/Waivers to the Design Standards" in Section 2.

NOTE:

1. Maps of state highways by functional classification and information on the access management program are on the VDOT web site.
2. The standards do not apply to proposed VDOT minor arterials, collectors and local streets if the construction design plans were presented at a VDOT public hearing prior to October 14, 2009 or principal arterials prior to July 1, 2008.

Table of Contents

DEFINITIONS	F-1
SECTION 1- INTRODUCTION	F-7
Access Management Concepts	F-7
Functional Classification	F-8
Functional Classification of State Highways	F-8
SECTION 2 – INTERSECTION DESIGN; SPACING STANDARDS	F-11
Intersection Design Objectives	F-11
Intersection Design Principles.....	F-12
Minimum Angle of Intersections.....	F-18
Signalized Intersection Spacing.....	F-21
General Intersection and Entrance Spacing Criteria.....	F-22
Minimum Spacing Standards for Commercial Entrances, Intersections, and Crossovers.....	F-23
Spacing Standards for Commercial Entrances/Intersections Near Interchange Ramps ...	F-27
Exceptions/Waivers to the Spacing Standards	F-29
Exceptions / Waivers to the Design Standards.....	F-29
Crossover Location Approval Process.....	F-30
Signalized and Unsignalized Intersection Design	F-31
Stopping Sight Distance.....	F-34
Intersection Sight Distance	F-35
Median Openings/Crossovers	F-37
Crossover Grades.....	F-37
Intersecting Cross Road Grades.....	F-40
Roundabouts.....	F-40
The Approval Process for Roundabouts.....	F-42
Accommodating Pedestrians and Bicyclists	F-45
SECTION 3 – TURNING LANES	F-48
Turn Lane Criteria for Single and Dual Lanes.....	F-48
Warrants for Left Turn Storage Lanes on Four-Lane Highways	F-50
Warrants for Left Turn Storage Lanes on Two-Lane Highways.....	F-51
Lane/Transitions, Merging Tapers and Speed Change Lengths.....	F-53
Double (Dual) Left-Turn Lanes	F-64
Continuous Left-Turn Lanes (Two Way in Either Direction).....	F-64
Medians	F-67
Illustration of Directional Median Opening for Left Turns and U-Turns.....	F-69
Right Turn Lanes	F-70
Acceleration Lanes	F-74

SECTION 4 – ENTRANCE DESIGN	F-80
Entrance Design Principles.....	F-80
Private and Low Volume Commercial Entrances	F-81
Commercial Entrances.....	F-83
Limits of Maintenance Responsibility for Private and Commercial Entrances.....	F-87
Commercial Entrance Location Criteria	F-87
Commercial Entrance Sight Distance	F-89
Restricting Left Turn Movements at Commercial Entrances	F-89
Commercial Entrance Channelization Island Options	F-90
Commercial Entrance Spacing	F-91
Corner Clearance on a Minor Side Street.....	F-91
Entrance Connections on Opposite Sides of a Roadway	F-93
Entrance Consolidation (Shared Use Entrances)	F-94
Shared Entrances and Internal Site Interconnection	F-94
Frontage Roads	F-96
Entrances Affected by Highway Construction Projects.....	F-97
Commercial Entrance Design to Serve A Private Subdivision Road / Street	F-99
Commercial Entrance Designs along Highways with Shoulders	F-100
Commercial Entrance Designs along Highways with Curb and Gutter.....	F-101
Commercial Entrance Design along Local Streets with Curb and Gutter or Shoulders... F-102	
Commercial Entrance Designs along Highways with Shoulders at Intersection.....	F-103
Commercial Entrance Designs along Highways with Curb and Gutter at Intersection	F-104
Commercial Entrance Designs to Serve Drive-In Type Businesses.....	F-105
Moderate Volume Commercial Entrance Design along Highways with Shoulders	F-106
 BIBLIOGRAPHY	 F-107

List of Tables and Figures

(Figures shown are for illustration purposes only, unless otherwise noted.)

Figure 1-1 Schematic of a Functionally Classified Roadway Network	F-9
Figure 2-1 Conflict Points.....	F-12
Figure 2-2 Vehicular Circulation Between Adjoining Properties.....	F-15
Figure 2-3 Types of Access Channelization.....	F-16
Figure 2-4 Types of Access Channelization.....	F-17
Figure 2-5 U-Turn Design Options.....	F-18
Figure 2-6 Minimum Angle of Intersections.....	F-18
Figure 2-7 Access Development Scenario Along a State Highway.....	F-19
Figure 2-8 Illustration of Entrance and Intersection Spacing.....	F-20
Table 2-1 Relationship Between Speed, Cycle Length, & Signal Spacing.....	F-22
Table 2-2 Minimum Spacing Standards for Commercial Entrances, Intersections and Crossovers	F-23
Figure 2-8.1 Illustration of The Relationship Between Spacing Standards	F-26
Table 2-3 Minimum Spacing Standards For Commercial Entrances and Intersections Near Interchange Areas on Multilane Crossroads	F-27
Figure 2-9 Access Control on Multi Lane Highways at Interchanges.....	F-27
Table 2-4 Minimum Spacing Standards For Commercial Entrances and Intersections Near Interchange Areas on Two-Lane Crossroads.....	F-28
Figure 2-10 Access Control on Two Lane Highways at Interchanges.....	F-28
Figure 2-11 Intersection Design For Rural Applications With or Without Standard Si-1 Sign Island Design	F-32
Figure 2-12 Intersection Design For Rural Applications With or Without Standard Si-2 or Si-3 Sign Island Design.....	F-33
Table 2-5 Stopping Sight Distance.....	F-34
Table 2-6 Stopping Sight Distance on Grades.....	F-34
Table 2-7 Intersection Sight Distance	F-35
Figure 2-13 Crossovers With and Without Connections	F-38
Figure 2-14 Roundabout Design Details	F-44
Figure 2-15 Reducing The Number of Entrances Benefits Pedestrians and Bicyclists ...	F-46
Figure 3-1 Turn Lane Criteria for Single and Dual Lanes.....	F-48
Figure 3-2 Left and Right Turn Storage and Taper Lengths	F-49
Figure 3-3 Warrants For Left Turn Storage Lanes on Four-Lane Highways	F-50
Table 3-1 Warrants For Left Turn Lanes On Two-Lane Highways.....	F-51
Figure 3-4 Passing/Left Turn Lane On Two-Lane Highway	F-52
Figure 3-5 Warrant For Left-Turn Storage Lanes on Two-Lane Highway	F-54
Figure 3-6 Warrant For Left-Turn Storage Lanes on Two-Lane Highway	F-55
Figure 3-7 Warrant For Left-Turn Storage Lanes on Two-Lane Highway	F-55
Figure 3-8 Warrant For Left-Turn Storage Lanes on Two-Lane Highway	F-56
Figure 3-9 Warrant For Left-Turn Storage Lanes on Two-Lane Highway	F-56
Figure 3-10 Warrant For Left-Turn Storage Lanes on Two-Lane Highway	F-57
Figure 3-11 Warrant For Left-Turn Storage Lanes on Two-Lane Highway	F-57
Figure 3-12 Warrant For Left-Turn Storage Lanes on Two-Lane Highway	F-57

Figure 3-13 Warrant For Left-Turn Storage Lanes on Two-Lane Highway	F-58
Figure 3-14 Warrant For Left-Turn Storage Lanes on Two-Lane Highway	F-59
Figure 3-15 Warrant For Left-Turn Storage Lanes on Two-Lane Highway	F-59
Figure 3-16 Warrant For Left-Turn Storage Lanes on Two-Lane Highway	F-59
Figure 3-17 Warrant For Left-Turn Storage Lanes on Two-Lane Highway	F-60
Figure 3-18 Warrant For Left-Turn Storage Lanes on Two-Lane Highway	F-60
Figure 3-19 Warrant For Left-Turn Storage Lanes on Two-Lane Highway	F-61
Figure 3-20 Warrant For Left-Turn Storage Lanes on Two-Lane Highway	F-61
Figure 3-21 Warrant For Left-Turn Storage Lanes on Two-Lane Highway	F-62
Figure 3-22 Warrant For Left-Turn Storage Lanes on Two-Lane Highway	F-62
Table 3-23 Truck Adjustments	F-63
Figure 3-23 Double Left-Turn Lanes	F-65
Figure 3-24 Continuous Two-Way Median Left-Turn Lanes	F-66
Figure 3-25 Illustration Of Directional Median Opening For Left Turns And U-Turns....	F-69
Figure 3-26 Guidelines For Right Turn Treatment (2-Lane Highway)	F-72
Figure 3-27 Guidelines For Right Turn Treatment (4-Lane Highway)	F-73
Figure 3-28 Typical Application with Sidewalks and Bike Lanes with Right-Turn Deceleration Lanes (Curb and Gutter Section)	F-75
Figure 3-29 Typical Application of a Bus Pullout.....	F-76
Figure 3-30 Typical Application of a Right Turn Deceleration Lane (Shoulder Section)	F-77
Figure 3-31 Typical Application of a Left Turn Deceleration Lane (Shoulder Section) ..	F-78
Figure 3- 32 Typical Application of a Right Turn Acceleration and Deceleration Lane (Shoulder Section)	F-79
Table 4-1 Design Vehicle and Turning Radius By Land Use	F-80
Figure 4-1 Private Entrance and Low Volume Commerical Entrance Detail	F-82
Table 4-2 Summary of Entrance Throats	F-84
Figure 4-1A Entrance Throat Detail	F-84
Figure 4-2 Limits of Maintenance Responsibility for Private & Commercial Entrance...	F-87
Figure 4-2A Physical and Functional Areas of Intersection.....	F-87
Figure 4-3 Functional Area of Intersection	F-88
Figure 4-5 Commercial Entrance Channelization Island Options.....	F-90
Figure 4-4 Corner Clearance	F-92
Figure 4-6 Entrance Connections on Opposite Sides of a Roadway	F-93
Figure 4-7 Shared Entrance and Internal Site Connection.....	F-95
Figure 4- 8 Commercial Entrance Design To Serve a Private Subdivision Road / St. ..	F-99
Figure 4- 9 Commercial Entrance Designs Along Highways with Shoulders	F-100
Figure 4-10 Commercial Entrance Designs Along Highways with Curb and Gutter....	F-101
Figure 4-11 Commercial Entrance Designs Along Local Streets	F-102
Figure 4-12 Commercial Entrance Designs Along Highways with Shoulders at Intersection	F-103
Figure 4-13 Commercial Entrance Designs Along Highways with Curb & Gutter at Intersection	F-104
Figure 4-14 Commercial Entrance Designs To Serve Drive-In Type Businesses	F-105
Figure 4-15 Moderate Volume Commercial Entrance Design Along Highways with Shoulders.....	F-106

DEFINITIONS

Acceleration Lane: An auxiliary lane, including tapered areas, that enables a motorist to increase its speed to a rate that enables it to safely merge with through traffic.

Access Management: The systematic control of the location, spacing, design, and operation of entrances, median openings/crossovers, traffic signals, and interchanges for the purpose of providing vehicular access to land development in a manner that preserves the safety and efficiency of the transportation system.

Arterial: A major highway intended to serve through traffic where access is carefully controlled, generally highways of regional importance, intended to serve moderate to high volumes of traffic traveling relatively long distances and at higher speeds.

Auxiliary Lane: The portion of the roadway adjoining the traveled way for speed change, turning, storage for turning, weaving, truck climbing, and other purposes supplementary to through-traffic movement.

Channelization: The separation or regulation of conflicting traffic movements into definite paths of travel by traffic islands or pavement marking to facilitate safe and orderly movements of vehicles, pedestrians and bicyclists.

Collector: The functional classification of a highway that provides land access service and traffic circulation within residential, commercial, and industrial areas. The collector system distributes trips from principal and minor arterials through the area to the ultimate destination. Conversely, collectors also collect traffic from local streets in residential neighborhoods and channel it into the arterial system.

Commercial Entrance: Any entrance serving land uses that generate more than 50 vehicular trips per day or the trip generation equivalent of more than five individual private residences or lots for individual private residences using the methodology in the Institute of Transportation Engineers Trip Generation.

Conflict: A traffic conflict occurs when the paths of vehicles intersect, an event that causes a driver to take evasive action to avoid collision with another vehicle, usually designated by a braking application or evasive lane change.

Conflict Point: An area where intersecting traffic either merges, diverges or crosses. Each conflict point is a potential collision.

Corner Clearance: The distance an entrance on a minor side street needs to be separated from the minor side street's intersection with a major roadway. It is aimed at preventing the location of entrances within the functional area of an intersection. The major roadway will have the higher functional classification (excluding local streets), or will have the higher traffic volume.

Crossover: An opening in a nontraversable median that provides for crossing, left turns and U-turns*.

* Rev. 7/12

Curb Cut: An opening along the curb line where vehicles may enter or leave the highway.

Deceleration Lane: A speed-change lane including tapered areas that enables a turning vehicle to exit a through lane and slow to a safe speed to complete its turn.

Design Speed: The selected speed used to determine the geometric design features of the highway.

Divided Highway: A highway on which traffic traveling in opposite directions is physically separated by a median.

Entrance: Any driveway, street or other means of providing for the movement of vehicles to or from the state highway system.

Entrance Throat: The distance parallel to the centerline of an entrance to the first on-site location at which a driver can make a right turn or a left turn, measured on highways with curb and gutter, from the face of the curb, and on highways without a curb and gutter, from the edge of the shoulder.

Entrance Width: The distance edge-to-edge of an entrance measured at the right-of-way line.

Egress: The exit of vehicular traffic from a property to a highway.

Exception: Permission to depart from standards because of the unique circumstances of the site or project.

Frontage Road: A road that generally runs parallel to a highway between the highway right-of-way and the front building setback line of the abutting properties and provides access to the abutting properties for the purpose of reducing the number of entrances to the highway and removing the abutting property traffic from through traffic on the highway.

Full Access Entrance: Entrance which allows left-in and left-out movements and right-in and right-out movements.

Functional Area of an Intersection: The area beyond the physical intersection that comprises decision and maneuver distance, plus any required vehicle storage length, and is protected through corner clearance standards and connection spacing standards.

Functional Classification: The federal system of classifying groups of highways according to the character of service they are intended to provide and classifications made by the Commissioner based on the operational characteristics of a highway. Each highway is assigned a functional classification based on the highway's intended purpose of providing priority to through traffic movement or adjoining property access. The functional classification system groups highways into three basic categories identified as (1) arterial, with the function to provide through movement of traffic; (2) collector, with the function of supplying a combination of through movement and access to property; and (3) local, with the function of providing access to property.

Grade Separation: A crossing of two highways or a highway and a railroad, or a highway and a pedestrian walkway, at different elevations.

Gradient or Grade: The rate or percentage change in slope, measured along the centerline of the highway or entrance, either ascending or descending from or along the highway.

Highway, Street, or Road: A public right of way for purposes of vehicular travel, including the entire area within the right-of-way.

Ingress: The entrance of vehicular traffic into a property from a highway.

Interchange: A grade-separated system of access to and from highways that includes directional ramps for access to and from crossroads.

Intersection: An at-grade crossing of two or more highways, a crossover, or any at-grade connection with a highway such as a commercial entrance.

Intersection Sight Distance: The sight distance required at an intersection to allow the driver of a stopped vehicle a sufficient view of the intersecting highway to decide when to enter, or cross, the intersecting highway.

Legal Speed Limit: The speed limit set forth on signs lawfully posted on a highway or in the absence of such signs the speed limit established by Title 46.2, Chapter 8, Article 8 of the Code of Virginia

Limited Access Highway: A highway especially designed for through traffic over which abutters have no easement or right of light, air, or access by reason of the fact that their property abuts upon the limited access highway.

Local Streets/Roads: The functional classification for highways that comprise all facilities that are not collectors or arterials. Local streets serve primarily to provide direct access to abutting land and to other streets.

Low Volume Commercial Entrance: Any entrance, other than a private entrance, serving five or fewer individual residences or lots for individual residences on a privately owned and maintained road or land uses that generate 50 or fewer vehicular trips per day using the methodology in the Institute of Transportation Engineers Trip Generation.*

Median: That portion of a divided highway that separates opposing traffic flows, not including center two-way left-turn lanes, can be traversable or non-traversable.

Median, Non-traversable (Restrictive Median): A physical barrier that separates traffic traveling in opposite directions, such as a concrete barrier or landscaped island.

* Rev. 1/12

Median Opening (Directional): An opening in a restrictive median that provides for specific movements and physically restricts other movements.*

Median Opening (Full): See “Crossover”.

Median, Traversable (Nonrestrictive Median): A median that by its design does not physically discourage or prevent vehicles from entering upon or crossing over it, including painted medians.

Merge: The process by which two separate traffic streams moving in the same direction combine or unite to form a single stream.

Minor Arterial: The functional classification for highways that interconnect with and augment the principal arterial system. Minor arterials distribute traffic to smaller geographic areas providing service between and within communities.

Operating Speed: The speed at which drivers are observed operating their vehicles during free-flow conditions with the 85th percentile of the distribution of observed speeds being the most frequently used measure of the operating speed of a location or geometric feature.

Passing Sight Distance: The length of roadway that the driver of the passing vehicle must be able to see initially, in order to make a passing maneuver safely.

Partial Access Entrance: Entrance with movements limited to right-in or right-out or both, with or without left-in movements.

Peak Hour Volume: The largest number of vehicles passing over a designated section of a street during the busiest 60-minute period within a 24-hour period.

Phase (Signal): That portion of a traffic signal cycle allocated to a specific traffic movement or combination of movements.

Primary Highway: The system of state highways assigned route numbers under 600.

Principal Arterial: The functional classification for a major highway intended to serve through traffic where access is carefully controlled, generally highways of regional importance, with moderate to high volumes of traffic traveling relatively long distances and at higher speeds.

Private Subdivision Road or Street Entrance: A entrance for a road or street that serves more than five individual properties and is privately owned and maintained.

* Rev. 7/12

Private Entrance: An entrance that serves up to two private residences and is used for the exclusive benefit of the occupants or an entrance that allows agricultural operations to obtain access to fields or an entrance to civil and communication infrastructure facilities that generate 10 or fewer trips per day such as cell towers, pump stations, and stormwater management basins.

Ramp Terminal: That portion of a ramp adjacent to the through traveled way, including speed-change lanes, tapers, and islands. Ramp terminals may be the at-grade type, as at the crossroad terminal of diamond or partial cloverleaf interchanges, or the free-flow type where ramp traffic merges with or diverges from high-speed through traffic at flat angles.

Right-of-way: That property within the systems of state highways that is open or may be opened for public travel or use or both in the Commonwealth. This definition includes those public rights-of-way in which the Commonwealth has a prescriptive easement for maintenance and public travel. The property includes the traveled way and associated boundary lines and parking and recreation areas.

Roadway: The portion of a highway, including shoulders, for vehicular use. A divided highway has two or more roadways.

Roundabout: A circular intersection with yield control of all entering traffic, right-of-way assigned to traffic within the circular roadway, and channelized approaches and a central island that deflect entering traffic to the right.

Rural Area: The areas outside the boundaries of urbanized areas and urban places (see Urban Area).*

Secondary Highway: The system of state highways assigned route numbers 600 and above.

Shared Entrance: A single entrance to provide access to two or more adjoining parcels.

Shoulder: The portion of the highway that lies between the edge of the traveled way and the break point, excluding turn lanes.

Sight Distance: The distance visible to the driver of a vehicle when the view is unobstructed by traffic.

Sight Triangle: An area of unobstructed sight distance along both approaches of an entrance.

Signal Progression: The progressive movement of traffic, at a planned rate of speed without stopping, through adjacent signalized locations within a traffic control system.

Signal Spacing: The distance between traffic signals along a highway.

* Rev, 1/12

Stopping Sight Distance: The distance required by a driver of a vehicle, traveling at a given speed, to bring the vehicle to a stop after an object on the highway becomes visible, including the distance traveled during the driver's perception and reaction times and the vehicle braking distance.

Storage Length: Lane footage added to a deceleration lane to store the maximum number of vehicles likely to accumulate during a peak period, so as not to interfere with the through-travel lanes.

Taper: The widening of pavement to allow the redirection and transition of vehicles around or into a turn lane; of two types: (a) redirect tapers necessary for the redirection of vehicles along the traveled way; and (b) transition tapers for turn lanes that allow the turning vehicle to transition from or to the traveled way, to or from a turn lane.

Through Movement: The predominant direction of traffic flow through an intersection, straight on most major roads, although the predominant flow of traffic occasionally is in a right or left-turning direction.

Traveled Way: The portion of the highway provided for the movement of vehicles, exclusive of shoulders and turn lanes.

Turn Lane: A separate lane for the purpose of enabling a vehicle that is entering or leaving a highway to increase or decrease its speed to a rate at which it can more safely merge or diverge with through traffic; acceleration and deceleration lanes.

Urban Area: An urbanized area (population of 50,000 and over), or an urban place as designated by the Bureau of the Census (population of 5,000 or more) and not within any urbanized area, with boundaries fixed by State and local officials and approved by the Federal Highway Administration.*

VPH: The number of vehicles per hour, usually referring to vehicles in a peak hour.

Warrant: The criteria by which the need for a safety treatment or highway improvement can be determined.

Weaving: The crossing of two or more traffic streams traveling in the same general direction along a significant length of highway, without the aid of traffic control devices. Weaving areas are formed when a merge area is closely followed by a diverge area, or when an entrance ramp is closely followed by an exit ramp and the two ramps are joined by an auxiliary lane.

* Rev. 1/12

SECTION 1- INTRODUCTION

Access Management Concepts

Access management provides a systematic approach to balancing the access and mobility necessities of a roadway. Access management can be defined as the process of managing access to land development, while simultaneously preserving the flow of traffic on the surrounding public road system.

Property owners have a right to reasonable access to the general system of streets and highways. In conjunction, adjacent roadway users have the right to freedom of movement, safety, and efficient expenditure of public funds. Balancing these interests is critical at locations where significant changes to the transportation system and/or surrounding land uses are occurring. The safe and efficient operation of the transportation system calls for effectively managing highway access, via entrances, streets, or other access points.

The specific techniques for managing access involve the application of established traffic engineering and planning principles. Ideally, these principles will:

- Limit the number of traffic conflicts;
- Separate basic conflict areas;
- Separate turning volumes from through movements;
- Provide sufficient spacing between at-grade intersections;
- Maintain progressive speeds along arterials;
- Provide adequate on-site storage lanes.

The application of these principles will minimize disruptions to through traffic caused by entrances and intersections. More specifically, good access management can:

- Reduce crashes and crash potential;
- Preserve roadway capacity and the useful life of roads;
- Decrease travel time and congestion;
- Improve access to properties;
- Coordinate land use and transportation decisions;
- Improve air quality;
- Maintain travel efficiency and related economic prosperity.

Functional Classification

The Federal Highway Administration's (FHWA) "Functional Classification Guidelines" state that Functional Classification is the process by which streets and highways are grouped into classes or systems, according to the character of service they are intended to provide.

Basic to this process is the recognition that individual roads and streets do not serve travel independently in any major way. Rather, most travel involves movement through a network of roads. It becomes necessary then to determine how this travel can be channelized within the network in a logical and efficient manner.

Functional classification defines the nature of this channelization process by defining the part that any particular road should play in serving the flow of trips through a highway network. Allied to the idea of traffic channelization is the dual role the highway network plays in providing (1) access to property, and (2) travel mobility. Mobility can be provided at varying levels, usually referred to as "level of service." It can incorporate a wide range of elements (e.g., riding comfort and freedom from speed changes) but the most basic is operating speed or trip travel time. The four major functional classifications are:

- Principal arterial is a major highway intended to serve through traffic where access is carefully controlled, generally highways of regional importance, with moderate to high volumes of traffic traveling relatively long distances and at higher speeds.
- Minor arterials are highways that interconnect with and augment the principal arterial system. Minor arterials distribute traffic to smaller geographic areas providing service between and within communities.
- Collector is a highway that provides land access service and traffic circulation within residential, commercial, and industrial areas. The collector system distributes trips from principal and minor arterials through the area to the ultimate destination. Conversely, collectors also collect traffic from local streets in residential neighborhoods and channel it into the arterial system.
- Local streets/roads comprise all facilities that are not collectors or arterials. Local streets serve primarily to provide direct access to abutting land and to other streets.*

Functional Classification of State Highways

Information on the process for establishing a functional classification for a new road or for changing the functional classification for an existing highway is available on the VDOT web site at [Functional Classification](#). Maps identifying the functional classification of all state highways are also presented on this web site.

* Rev. 1/12

Schematic of a Functionally Classified Roadway Network

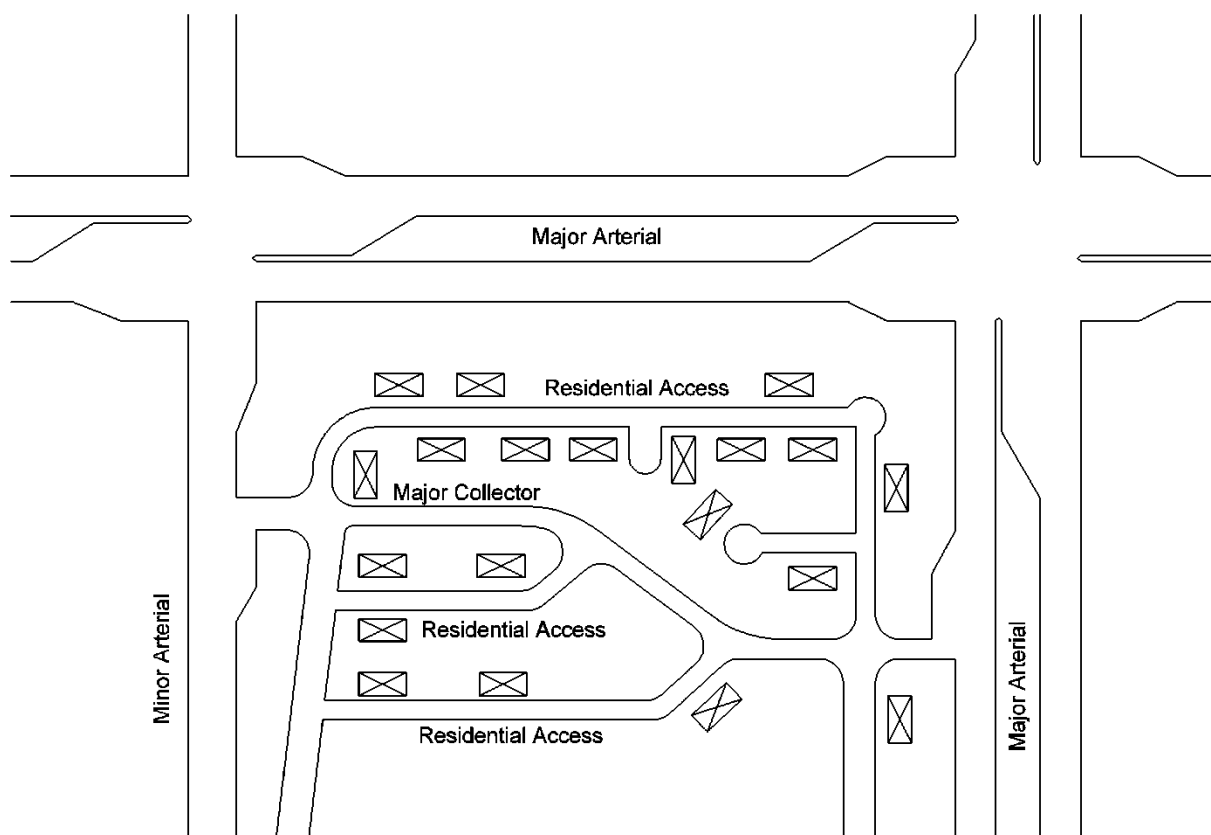
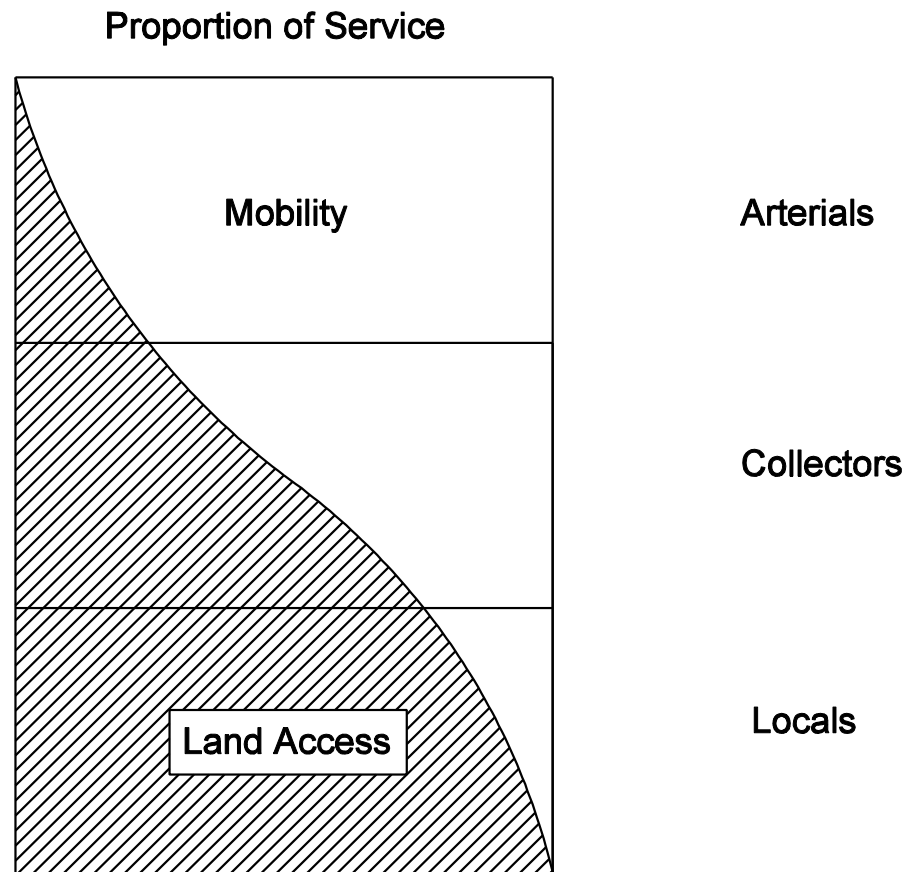

FIGURE 1-1

Source: Transportation Research Board, Access Management Manual, 2003

Relationship of Functionally Classified Systems in Serving Traffic Mobility and Land Access



Source: A Policy on Geometric Design of Highways and Streets, AASHTO, 2011
AASHTO Green Book

It was pointed out in the discussion above that the concept of traffic channelization leads logically not only to a functional hierarchy of systems, but also to a parallel hierarchy of relative travel distances served by those systems. This hierarchy of travel distances can be related logically to a desirable functional specialization in meeting the access and mobility requirements. Local facilities emphasize the land access function. Arterials emphasize a high level of mobility for through movement. Collectors offer a compromise between both functions. This is illustrated conceptually above.

Functional classification can be applied in planning highway system development, determining the jurisdictional responsibility for particular systems, and in fiscal planning. These applications of functional classification are discussed in "A Guide for Functional Highway Classification."

SECTION 2 – INTERSECTION DESIGN; SPACING STANDARDS

Intersection Design Objectives

Intersection design, including entrances, must consider the following items:

- Total approach traffic, design hourly volumes, and turning volumes.
- Composition of traffic (percent of passenger cars, buses, trucks, etc.)
- Operating speed of vehicles
- Functional Classification of Highways
- Adjacent land use
- Physical and Environmental Characteristics
- Pedestrian and Bicycle Accommodation

Major objectives of traffic design concern safety, operational efficiency and driver expectation through consideration of the following:

- The design should fit the natural transitional paths and operating characteristics of drivers and vehicles. Smooth transitions should be provided for changes in direction.
- Grades at intersections should be as nearly level as possible.
- Sight distances must be sufficient to enable drivers to prepare for and avoid potential conflicts.
- On major roadways, intersections must be evenly spaced to enhance the synchronization of signals, increase driver comfort, improve traffic operation, and reduce fuel consumption and vehicle emissions.

Intersection Design Principles

Intersection Design Principles	
•	Limit Number of Conflict Points
•	Coordinate Design and Traffic Control
•	Avoid Complex Maneuvers
•	Separate Conflict Points
•	Favor Major Flows
•	Segregate Movements
•	Accommodate Pedestrians and Bicyclists
•	Consider the Design Vehicle
•	Consider a Roundabout Design

Intersection design principles are as follows:

- Limit the number of conflict points. The number of conflict points among vehicular movements increases significantly as the number of intersection legs increase. For example, an intersection with four two-way legs has 32 total conflict points, but an intersection with six two-way legs has 172 conflict points. Intersections with more than four two-way legs should be avoided wherever possible.

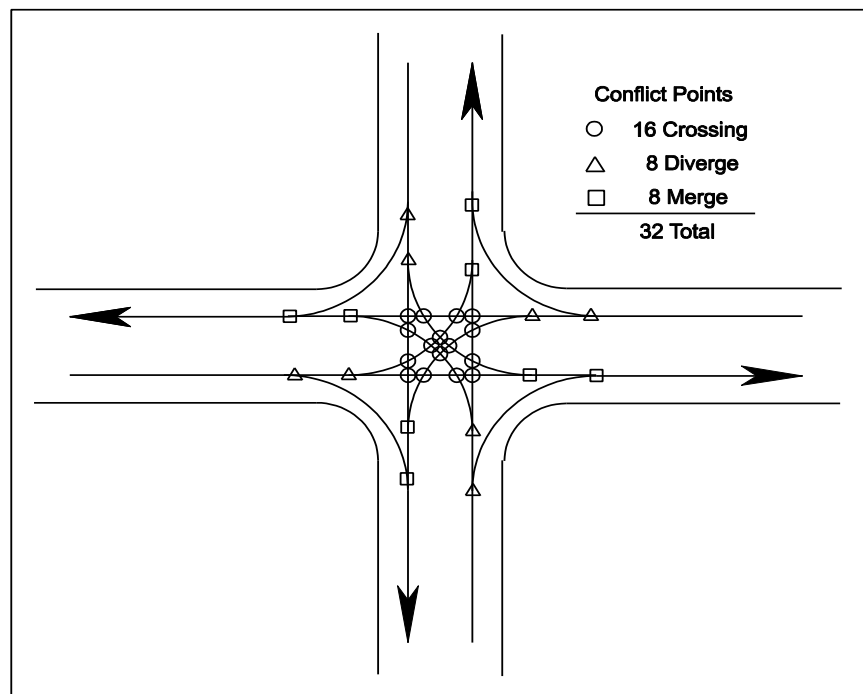

FIGURE 2-1 CONFLICT POINTS

Source: Transportation Research Board, Access Management Manual

- Coordinate design and traffic control. Maneuvers at intersections accomplished at low relative speeds require a minimum of traffic control devices. Maneuvers accomplished at high relative speeds are undesirable unless traffic controls such as stop signs or traffic signals are provided. Designs should separate vehicles making conflicting movements. Intersection design should be accomplished simultaneously with the development of traffic control plans.
- Avoid multiple and compound merging or diverging movements. These require complex driver decisions and create additional conflicts.
- Separate conflict points. Intersection hazards and delays are increased when intersection maneuver areas are too close together or when they overlap. Conflicts should be separated to provide drivers with sufficient time (and distance) between successive maneuvers for them to cope with the traffic conflicts one at a time.
- Favor the heaviest and fastest flows. The heaviest volume and higher speed flows should be given preference in intersection design to minimize hazard and delay.
- Minimize the area of the conflict. Excessive intersection area causes driver confusion and inefficient operations. Large areas are inherent with long curb return radii and in skewed and multiple-approach intersections. Channelization should be employed to limit the intersection and to guide drivers.
- Segregate movements. Separate lanes should be provided at intersections when there are appreciable volumes of traffic traveling at different speeds. Separate turning lanes should be provided for left and right turning vehicles. Left turns necessitate direct crossings of opposing vehicle paths and are usually made at speeds of 10 mph or less for reasons of safety and economy.

Right turns are also usually made at minimum speeds. However, right turns do not involve potential conflicts of such severity as left turns, and are more suited to individual treatment because they take place at the outside of the intersection area. Therefore, right turns may be designed for higher than minimum speeds where adequate right-of-way is available for wider turns.

- Accommodate the needs of pedestrians and bicyclists. For example, when pedestrians must cross wide streets, refuge islands are important for pedestrian safety. See Figures 3-25 and 3-28 for illustrations. The VDOT web page [Bicycling and Walking in Virginia](#) provides information on VDOT policies for accommodating pedestrians and bicyclists on state highways.

A detailed discussion on adapting highways for pedestrians and bicyclists is presented later in this section.

- Consider the design vehicle. The shapes and dimensions of turning paths vary for different turning speeds, different angles of turn, and different types and sizes of vehicles. The design vehicle must be identified and turning templates properly applied. See Table 4-1 for Design Vehicle Chart.
- Consider a roundabout design. Roundabouts offer an attractive design alternative to conventional intersections. Roundabouts are circular intersections with specific design and traffic control features that convert all vehicular movements to right turns and force traffic to enter and circulate at lower, more consistent speeds. The safety benefits of low vehicle speeds include less severe and less frequent crashes. See the Roundabouts Section for additional information on the use of, and VDOT's efforts to promote, roundabouts.

At-grade intersections must provide adequately for anticipated turning and crossing movements. AASHTO's A Policy on Geometric Design of Highways and Streets, "Intersections" should be reviewed for additional information to be considered in the design since the site conditions, alignment, sight distance, the need for turning lanes and other factors enter into the type of intersection design which would satisfy the design hour volume of traffic, the character or composition of traffic, and the design speed.

A Highway Capacity Manual (HCM) capacity or other appropriate analysis (Corsim/Synchro) should be performed for intersection capacity and signalization requirements, and include a queuing analysis.

Sufficient offset dimensions, pavement widths, pluses, and radii shall be shown in the plans by the designer to insure that sign islands are properly positioned. Care should be taken in the design of four-lane roadways with intersecting two-lane roadways.

If traffic conditions clearly warrant a four-lane divided design for the two-lane road at the intersection, the divided design must be constructed for a sufficient distance to allow for the approaching divided design and the subsequent stop condition ahead to be properly signed. The four-lane divided design should not be constructed unless it is clearly warranted and the approaches can be properly signed or the minor road is expected to be improved to a divided status in the near future.

Examples of typical geometric design applications are presented in Figures 2-3 and 2-4. Note: These examples are not all-inclusive. Other options may be developed, which would require VDOT approval.

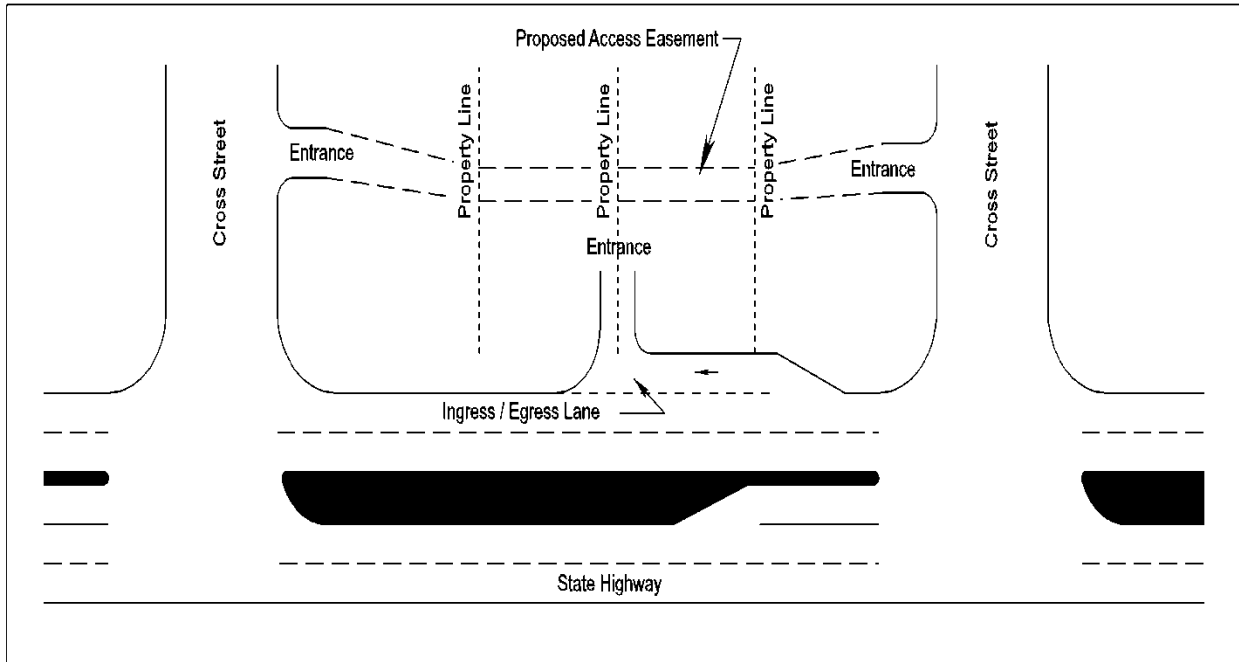

FIGURE 2-2 VEHICULAR CIRCULATION BETWEEN ADJOINING PROPERTIES

Reg. 24Vac 30-72-120.A4 & 24Vac 30-73-120.C4

Note: All entrance design and construction shall accommodate pedestrian and bicycle users of the highway in accordance with the Commonwealth Transportation Board's "Policy for Integrating Bicycle and Pedestrian Accommodations"

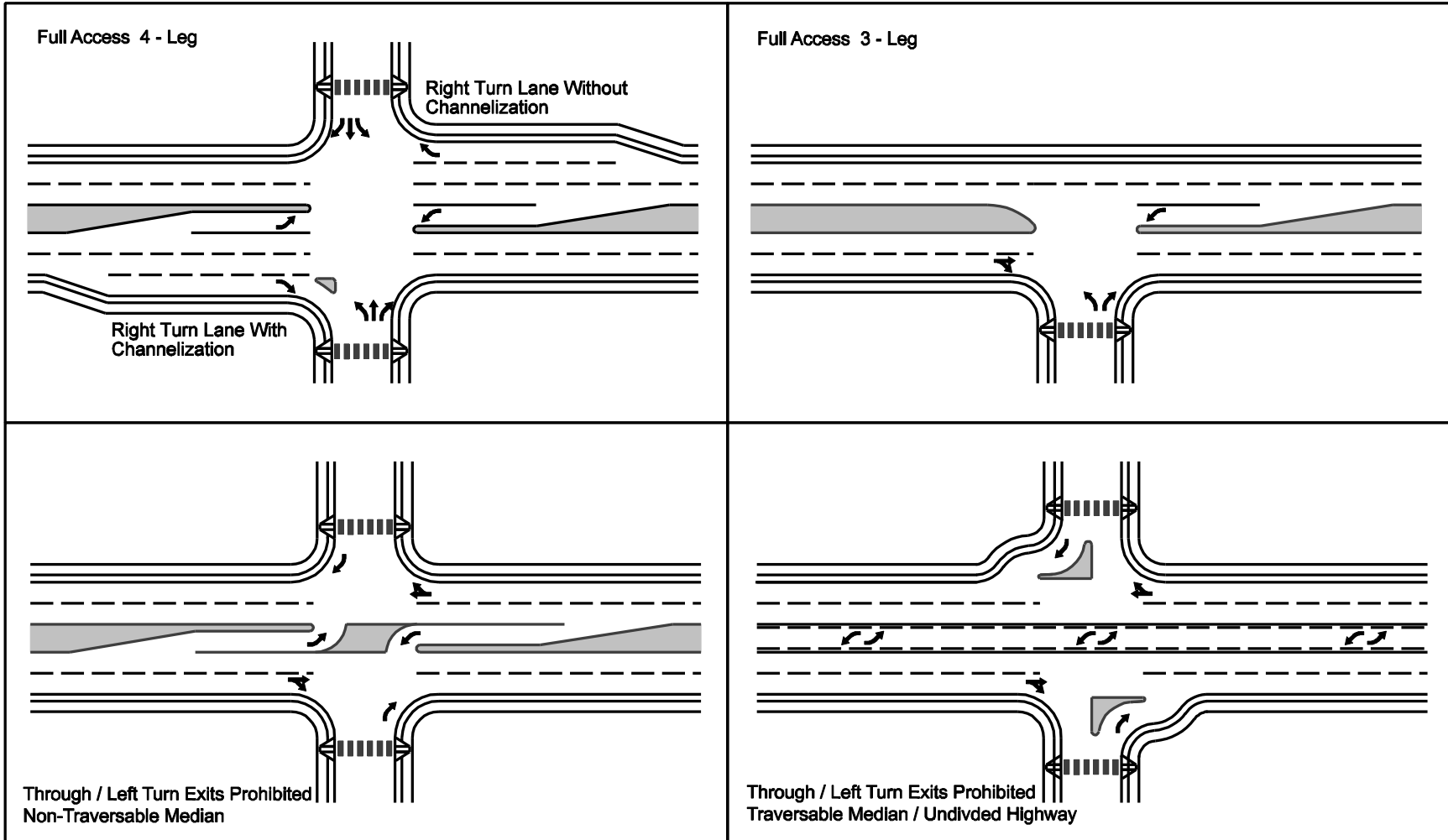

FIGURE 2-3 TYPES OF ACCESS CHANNELIZATION

Note: All entrance design and construction shall accommodate pedestrian and bicycle users of the highway in accordance with the Commonwealth Transportation Board's "Policy for Integrating Bicycle and Pedestrian Accommodations".

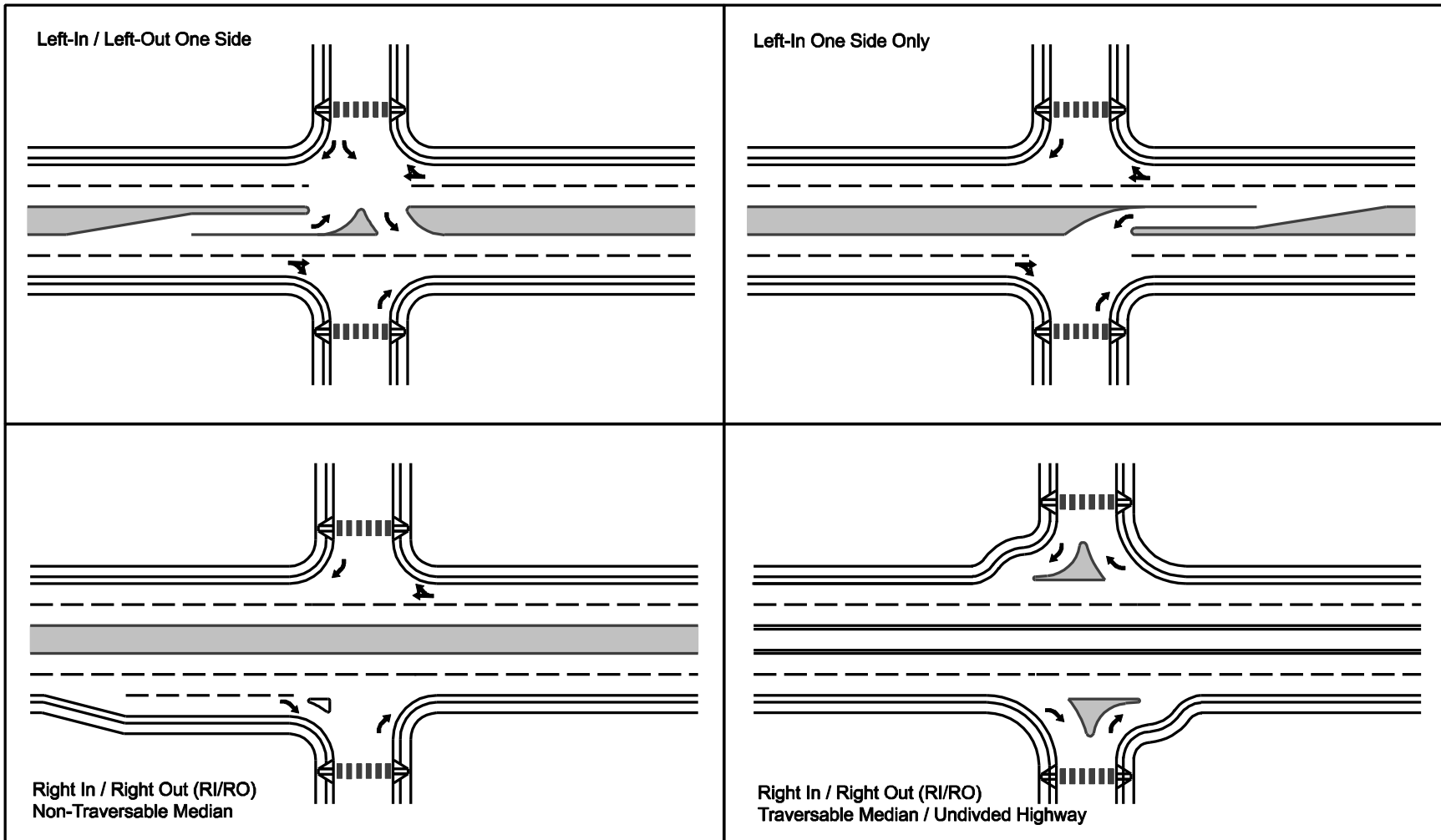

FIGURE 2-4 TYPES OF ACCESS CHANNELIZATION

Note: All entrance design and construction shall accommodate pedestrian and bicycle users of the highway in accordance with the Commonwealth Transportation Board's "Policy for Integrating Bicycle and Pedestrian Accommodations".

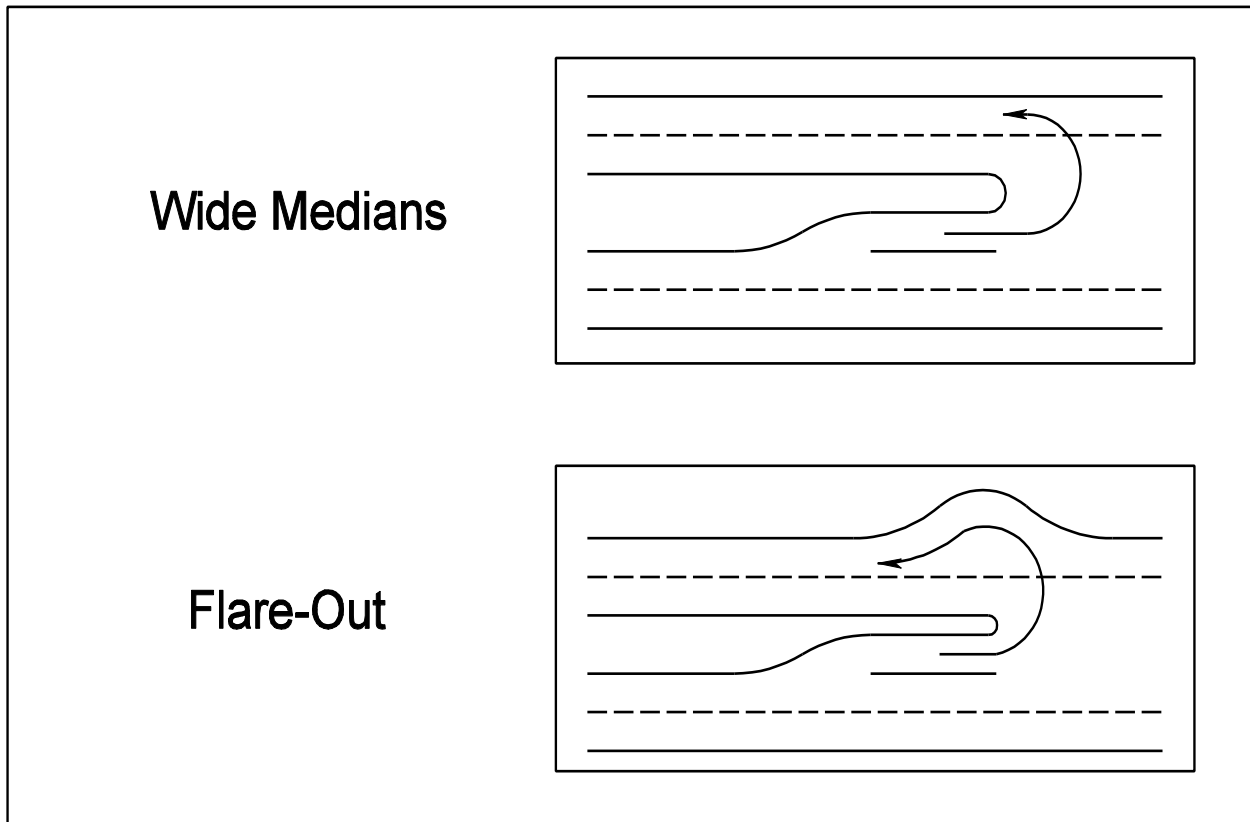
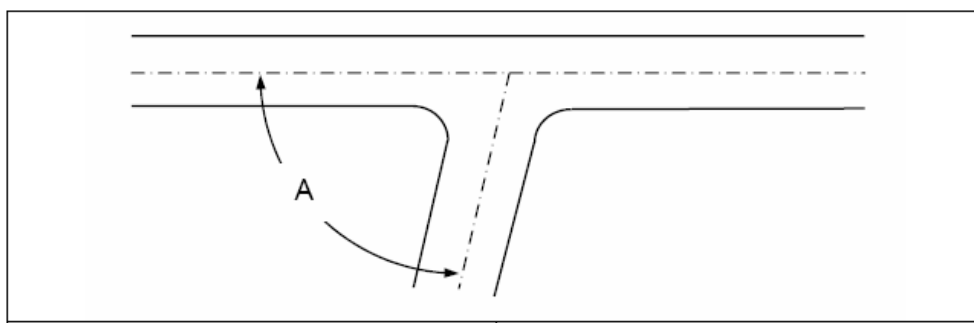

FIGURE 2-5 U-TURN DESIGN OPTIONS

Minimum Angle of Intersections

Streets should intersect at right angles; however, intersecting angles between 60 and 90 degrees are allowed.



Source: AASHTO "Green Book"

A = Minimum 60 degrees

FIGURE 2-6 MINIMUM ANGLE OF INTERSECTIONS

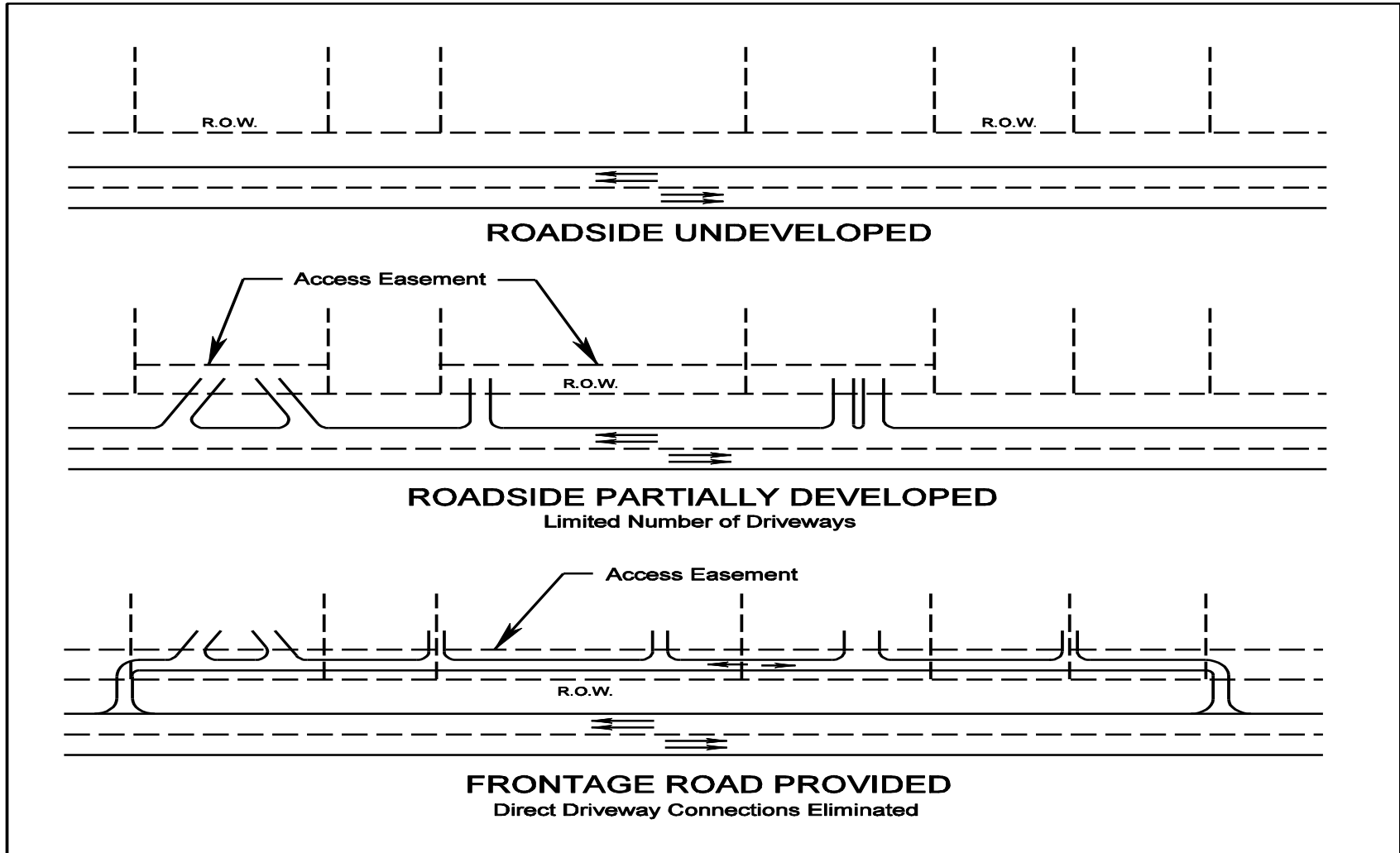
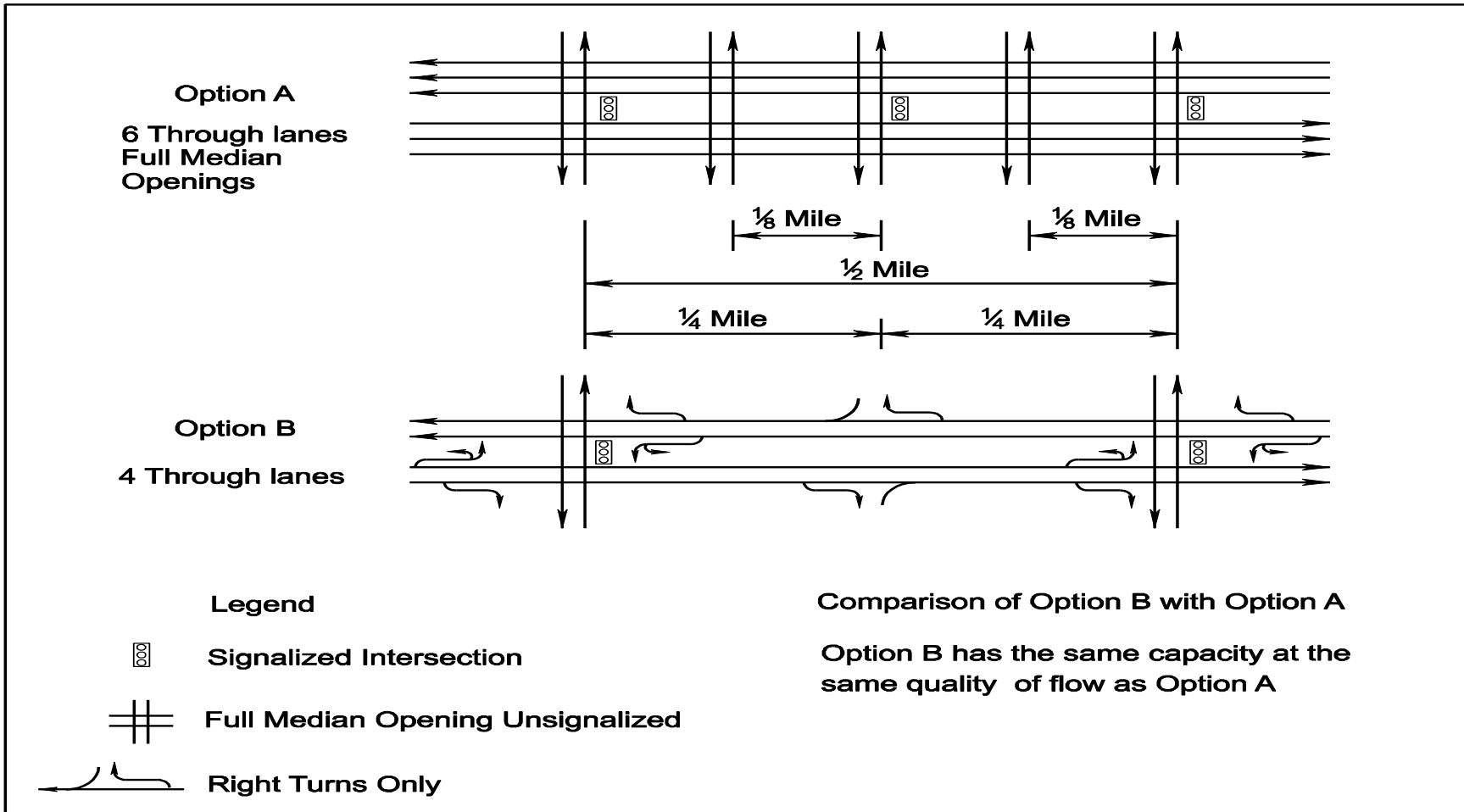

FIGURE 2-7 ACCESS DEVELOPMENT SCENARIO ALONG A STATE HIGHWAY

Note: All entrance design and construction shall accommodate pedestrian and bicycle users of the highway in accordance with the Commonwealth Transportation Board's "Policy for Integrating Bicycle and Pedestrian Accommodations".

ILLUSTRATION OF ENTRANCE AND INTERSECTION SPACING



Source: TRB, Access Management Manual, Dated 2003

FIGURE 2-8 ILLUSTRATION OF ENTRANCE AND INTERSECTION SPACING

Signalized Intersection Spacing

One of the variables involved in the planning, design and operation of signalized arterial streets is “Signalized Intersection Spacing” (See Table 2-2). Efficient traffic progression is essential on arterials in order to maximize safety and capacity. Moreover, at high progression efficiencies, fewer vehicles are required to come to a stop. Deceleration noise is reduced: thus, vehicle emissions, fuel consumption and delay are minimized. Since capacity will always be an issue on an urban arterial once urban development has occurred, the signal spacing must be such that very high progression efficiencies can be obtained over a wide range of through and turn volumes which change over time and which differ by time of day.

Selecting long and uniform signalized intersection spacing is an essential element in establishing spacing standards. Several studies have found that the number of crashes and crash rates increases with the frequency of traffic signals. For example an increase in signal density from 2.0 or less to 2.1 to 4.0 signals per mile can result in a 70% increase in the average crash rate – from about 2.8 to 4.8 crashes per million vehicle miles. The increased number of signals per mile also results in poor fuel efficiency and excessive vehicle emissions.

(Source: TRB Access Management Manual. 2003)

Signalized Intersection Spacing
<ul style="list-style-type: none"> • Essential to Movement Function • Parameters <ul style="list-style-type: none"> - Speed - Cycle Length (“Green” Band desired) - Signal Spacing - Efficiency of Progression - Vehicle Mix - Grade - Queuing - Emergency Preemptions

Source: NHI Course No. 15255, additions made by Committee.

Arterials are intended to provide a high degree of mobility and serve the longer trips. Since movement, not access, is the principal function, access management is essential in order to preserve capacity and safety. [AASHTO’s “A Policy on the Geometric Design of Highways and Streets” (Green Book)]. Further, the adoption of functional design, in lieu of volume based design, represents a major change in the philosophy of planning and design of street and highway systems.

A uniform signal spacing of ½ mile provides for efficient signal progression at speeds of 30 mph to 60 mph along arterials. At these speeds maximum flow rates are achieved and fuel consumption and emissions are kept to a minimum.

Generally a ½ -mile spacing will enable traffic flow at a wide range of speeds with cycle lengths ranging from 60 to 120 seconds. ½-mile spacing is needed to provide efficient progressions at 30 mph with a 120-second cycle commonly used in developed urban areas during peak hours. At slower speeds the increase in headway will result in a serious reduction in flow rate. (Source: TRB Access Management Manual. 2003)

Cycle Length (s)	Spacing			
	1/8 mi (600 ft)	1/4 mi (1,320 ft)	1/3 mi (1,760 ft)	1/2 mi (2,640 ft)
	Progression Speed (mph)			
60	15	30	40	60
70	13	26	34	51
80	11	22	30	45
90	10	20	27	40
100	9	18	24	36
110	8	16	22	33
120	7.5	15	20	30

TABLE 2-1 RELATIONSHIP BETWEEN SPEED, CYCLE LENGTH, & SIGNAL SPACING

Source: TRB: Access Management Manual, 2003

General Intersection and Entrance Spacing Criteria

1. Functional classification of highway
 - Purpose of the highway for mobility vs. access to property
2. Highway speed limit
 - The higher the speed, the longer the distance to safely decelerate for turning movements
3. Traffic signal
 - Separation of signals for efficient traffic progression
4. Type of entrance or intersection
 - As the potential number of turning movements increases, so do the conflict points, leading to a greater potential for traffic crashes, particularly for left turns into and out of entrances or at intersections

Other criteria that may need to be considered for new crossover spacing is presented later in this section.

Deleted Information*

* Rev. 1/12

Minimum Spacing Standards for Commercial Entrances, Intersections, and Crossovers

Highway Functional Classification	Legal Speed Limit (mph) ^①	Minimum Centerline to Centerline Spacing (Distance) in Feet			
		Spacing from Signalized Intersections to Other Signalized Intersections ^②	Spacing from Unsignalized Intersections/Crossover to Signalized or Unsignalized Intersections/Crossovers ^③	Spacing from Full Access Entrances to Other Full Access Entrances and Any Intersection on Highways Without Restrictive Medians ^④	Spacing from Partial Access One or Two Way Entrances to Any Type of Entrance, Intersection or Crossover ^⑤
Principal Arterial	≤ 30 mph	1,050	880	440	250
	35 to 45 mph	1,320	1,050	565	305
	≥ 50 mph	2,640	1,320	750	495
Minor Arterial	≤ 30 mph	880	660	355	200
	35 to 45 mph	1,050	660	470	250
	≥ 50 mph	1,320	1,050	555	425
Collector	≤ 30 mph	660	440	225	200
	35 to 45 mph	660	440	335	250
	≥ 50 mph	1,050	660	445	360
Local Street ^⑥	Commercial entrance spacing: See Figure 4-11.				

TABLE 2-2 MINIMUM SPACING STANDARDS FOR COMMERCIAL ENTRANCES, INTERSECTIONS AND CROSSOVERS ^⑦*

Notes: **A. Entrances and restrictive medians** – Entrances opposite such medians have no left turn ingress/egress movements: the Partial Access Entrance spacing applies. Entrances on highways without such medians are full access entrances. Entrances directly opposite each other on a highway create an intersection.

B. Roundabouts –

- Are separated from signalized intersections and unsignalized intersections/crossovers by the Unsignalized Intersection spacing standard.
- Are separated from other roundabouts by the Partial Access Entrance spacing standard.
- Are measured from the outer edge of the nearest inscribed diameter, not the centerline.

C. Spacing standard exceptions – See the “Exceptions to Spacing Standards” section.

D. Right turn lanes - When a right turn lane will be installed at an entrance, the length of the turn lane needs to be considered when locating the entrance.

* Rev. 7/12

Footnotes to Table 2-2

① **Legal Speed Limit** – The speed limit set forth on signs lawfully posted on a highway or in the absence of such signs the speed limit established by Article 8 (§46.2-870 et seq.) of Chapter 8 of Title 46.2 of the Code of Virginia.

② **Signalized Intersection**– Spacing is allocated in fractions of a mile: (1/2 mile, 2,640 ft); (1/3 mile, 1,760 ft); (1/4 mile, 1,320 ft); (1/5 mile, 1,050 ft); (1/6 mile, 880 ft), (1/8 mile, 660 ft). It is based on (i) the Signalized Intersection Spacing section and Table 2-1 and (ii) *Transportation and Land Development* by Vergil Stover and Frank Koepke, Institute of Transportation Engineers: “Traffic signal control applied in a sequential pattern according to specific spacing criteria optimize traffic efficiency” ...”to reduce fuel consumption, reduce delay, reduce vehicular emissions and improve safety.”

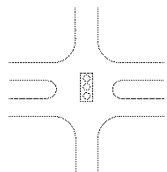

③ **Unsignalized Intersection/Crossover** – Intersections and crossovers need ample spacing to accommodate the complex situations faced by motorists from vehicular deceleration, acceleration, and numerous conflict points associated with vehicular crossing and left and right turning movements. At a four way intersections, these traffic movements’ create 32 conflict (collision) points (see Figure 2-1). Intersections and crossovers also may become signalized over time. Spacing is allocated in fractions of a mile (see footnote 2). **Note:** Roundabouts are separated from signalized and unsignalized intersections/crossovers by this spacing standard*.

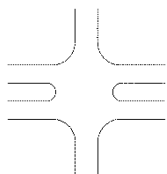

④ **Full Access Entrance Spacing** – Spacing can be less than unsignalized intersection and crossover spacing as there are fewer turning movements and potential conflict points and generally no crossing movements. However, studies have demonstrated that the majority of access related vehicular crashes involve left turns. The spacing is based on intersection sight distance for both four and two lane highways to assure that motorists approaching an entrance and those turning out of the entrance have sufficient time to react to highway and entrance traffic and to merge safely when making right and left turns. Again the purpose is to maintain the capacity and safety of the highway.

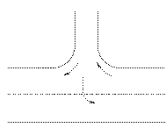

⑤ **Partial Access One or Two Way Entrance Spacing** – Left turn movements are limited (right in/right out with or without left in movement). The focus is on making sure motorists have sufficient time to be able to see/react to a vehicle slowing down to turn into the entrance or to a vehicle exiting the entrance, and stop in time to avoid a collision. Stopping sight distance can be used for this purpose. See Figure 4-5 for illustrations of commercial entrance channelization island options for creating a partial access entrance on highways without a restrictive non-traversable median. Also see “Restricting Left Turn Movements at Commercial Entrances” for additional information. **Note:** Roundabouts are separated from other roundabouts by the partial access entrance spacing standard.

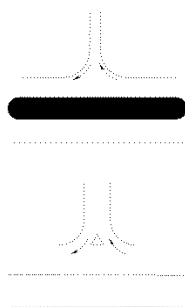

* Rev. 7/12

- ⑥ **Local Street Spacing** – For commercial entrances on local streets (not individual private entrance driveways to homes), a spacing distance of 50 ft between entrance radii is specified to assure a minimum separation between such entrances (illustrated in Figure 4-11).
- ⑦ **Corner Clearance** – Corner clearance is the minimum distance entrances on a minor side street need to be separated from an intersection to prevent queued vehicles from backing up into the highway or blocking entrances near the intersection. This separation protects the functional area of the intersection. The corner clearance distance will apply where it is greater than the Table 2-2 spacing standard. See Corner Clearance in Section 4 for more information.

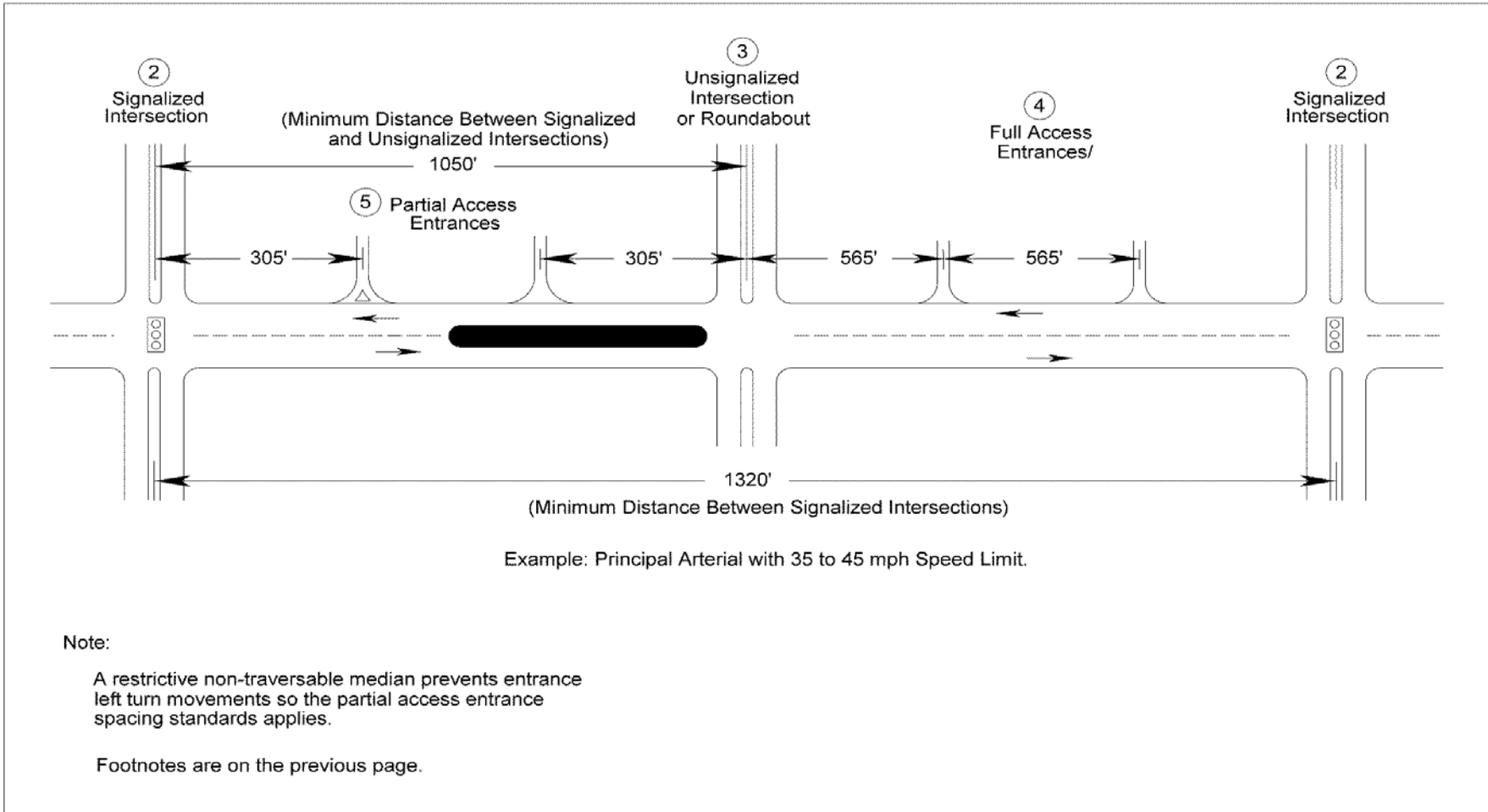

FIGURE 2-8.1 ILLUSTRATION OF THE RELATIONSHIP BETWEEN SPACING STANDARDS*

* Rev. 7/12

Spacing Standards for Commercial Entrances/Intersections Near Interchange Ramps

The spacing standards near interchange ramps focus on safe ramp exit and entry movements. Greater separation between ramp terminals and entrances and intersections is necessary for multilane versus two-lane highways because the motorist's maneuvers at multilane roads are more complex, such as crossing through lanes to reach a left turn lane at an intersection. Functional classification is not applied because arterials may be two lane or multilane. Note: If the off and/or on ramp has a full auxiliary lane, the spacing would be determined as if there were a ramp taper.

Spacing Dimension			
X	Y	Z	M
750'	1320'	750'	990'

TABLE 2-3 MINIMUM SPACING STANDARDS FOR COMMERCIAL ENTRANCES AND INTERSECTIONS NEAR INTERCHANGE AREAS ON MULTILANE CROSSROADS

Source: *Access Control Design on Highway Interchanges, 2008.*
 H. Rakha, A. M. Flintsch, M. Arafah, G. Abdel-Salam, D. Dua, and M. Abbas.
 Virginia Tech Transportation Institute, Blacksburg, VA

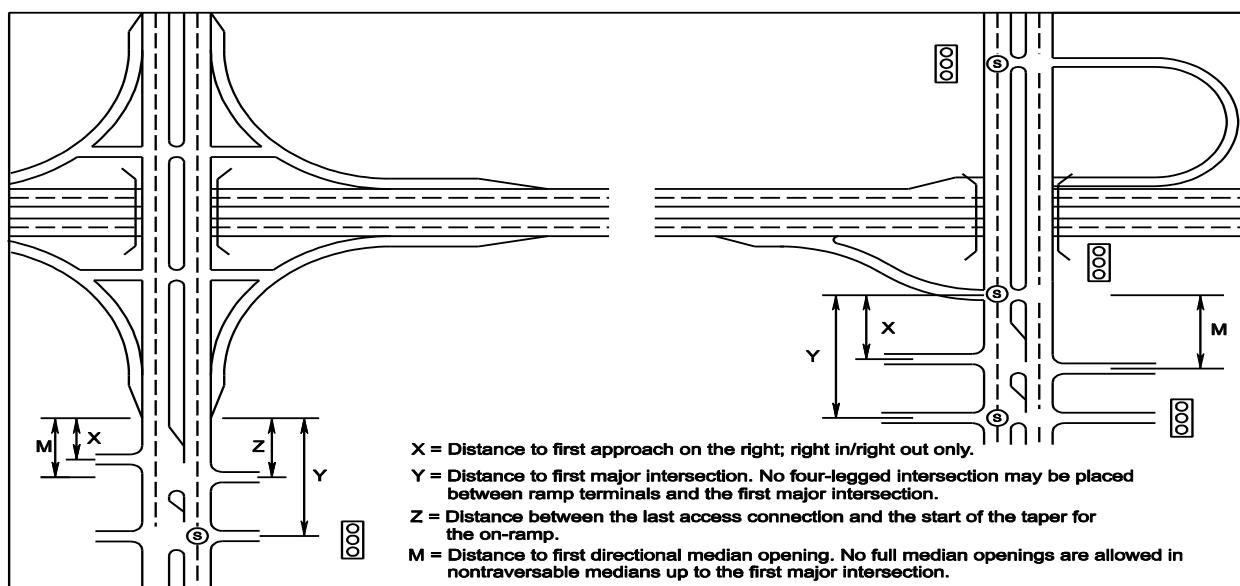

FIGURE 2-9 ACCESS CONTROL ON MULTI LANE HIGHWAYS AT INTERCHANGES

* Rev. 1/12

Minimum Spacing Standards for Commercial Entrances and Intersections Near Interchange Areas on Two-Lane Crossroads	
X or Z	Y
750'	1320'

TABLE 2-4 MINIMUM SPACING STANDARDS FOR COMMERCIAL ENTRANCES AND INTERSECTIONS NEAR INTERCHANGE AREAS ON TWO-LANE CROSSROADS

Source: *Access Control Design on Highway Interchanges, 2008.*
 H. Rakha, A. M. Flintsch, M. Arafteh, G. Abdel-Salam, D. Dua, and M. Abbas.
 Virginia Tech Transportation Institute, Blacksburg, VA*

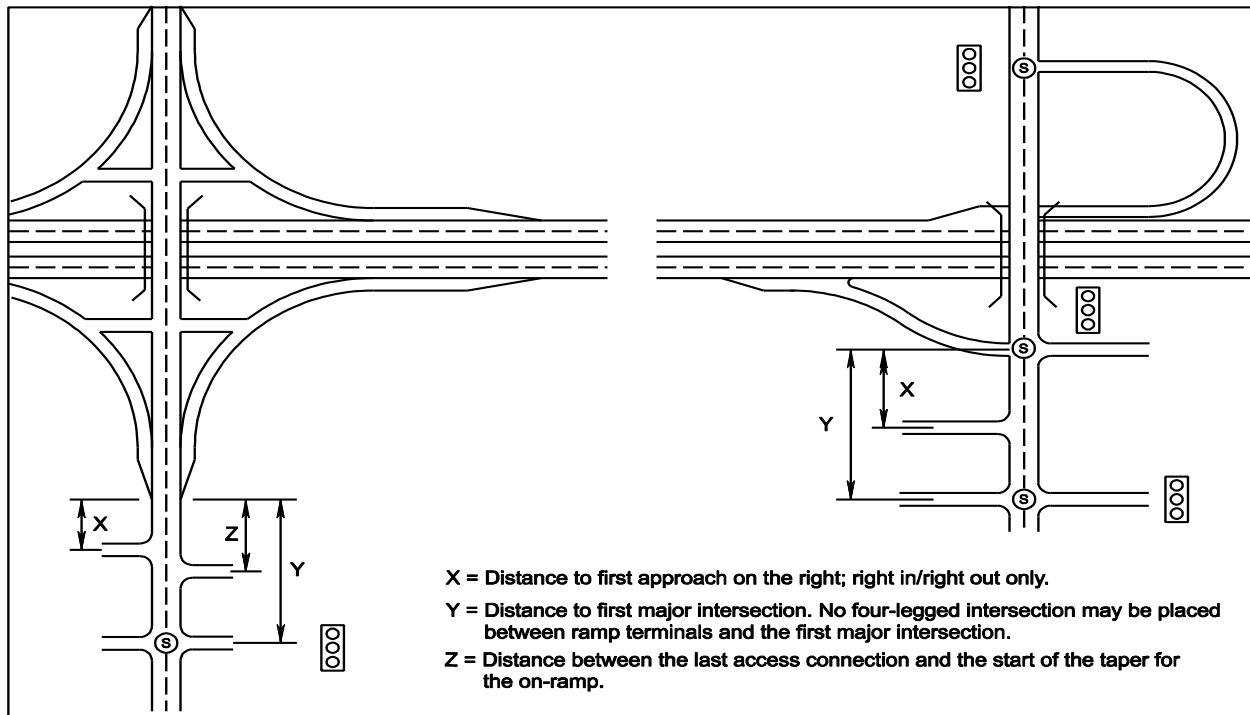

FIGURE 2-10 ACCESS CONTROL ON TWO LANE HIGHWAYS AT INTERCHANGES

* Rev. 1/12

Exceptions/Waivers to the Spacing Standards

The Access Management Regulations for Principal Arterials (24VAC30-72-120) and for Minor Arterials, Collectors, and Local Streets (24VAC30-73-120) identify potential exceptions to the spacing standards for commercial entrances, intersections, and crossovers found in Tables 2-2 through 2-4 in this Appendix. Exceptions to the spacing standards are referenced in sections 24VAC30-72-120 and 73-120 of the Access Management Regulations. See the VDOT Access Management web page for the regulations at www.virginiadot.org/projects/accessmgt.

For commercial entrances, intersections, and crossovers (new or to be relocated) proposed for private sector land development projects, the Access Management Regulations specify the documentation to be submitted to justify an exception to the spacing standards. A request for an exception to the spacing standards shall be submitted to the District Administrator or designee using Exception Form [AM-1](#) or [AM-2](#). These forms are available on the VDOT web site at <http://vdotforms.vdot.virginia.gov/>.

For highway construction or reconstruction projects on roadways owned and maintained by VDOT, a request for a waiver to the spacing standards shall be submitted to the District Location and Design Engineer using Waiver Form [AM-3](#). This form is available on the VDOT web site at <http://vdotforms.vdot.virginia.gov/>.

Exceptions / Waivers to the Design Standards

For both land development and highway construction projects **on VDOT owned and maintained roadways only**, the appropriate intersection sight distance from Table 2-7 must be met for all commercial entrances, intersections, and crossovers. If intersection sight distance cannot be met and a design waiver is granted (see below), then the minimum stopping sight distance from Table 2-6 must be met.*

If stopping sight distance cannot be met, a request for a design exception (Form [LD-440](#)) shall be submitted. If intersection sight distance cannot be met, a request for a design waiver (Form [LD-448](#)) shall be submitted. See [IIM-LD-227](#) for information on the exception and waiver review process for sight distance. [IIM-LD-227](#) is available at <http://www.virginiadot.org/business/locdes/rd-ii-memoranda-index.asp>. Sections 24VAC30-72-50B and 73-50 B in the Access Management Regulations also provide details on the stopping sight distance exception process.

For both private developments and highway construction projects, if any design standard in Appendix F (everything except the spacing standards) cannot be met, a request for a design exception (Form [LD-440](#)) or design waiver (Form [LD-448](#)) shall be submitted in accordance with [IIM-LD-227](#), available on the VDOT web site at <http://www.virginiadot.org/business/locdes/rd-ii-memoranda-index.asp>.

* Rev. 7/12

Crossover Location Approval Process

Overview

Tables 2-2 through 2-7 show the minimum crossover spacing and sight distance requirements to be applied on all divided highways without full control of access. Crossovers not meeting these minimums will only be allowed after an individual traffic safety and operational study and approval as outlined below.

The following are some factors, but not all inclusive, that should be considered in the study, if applicable: Operating speed, volume and composition of traffic for crossover and through routes, signal operation and traffic progression, accidents with and without additional crossover, number of U-turns, weaving maneuvers, alternative solution(s), capacity analysis, etc.

Private Sector Crossover Requests

The District Transportation and Land Use Director should consult with the Regional Traffic Engineer concerning private sector (developer) requests for a new crossover or to relocate or close an existing crossover on VDOT owned and maintained highways. **A crossover request that complies with the spacing standards, the sight distance requirements, and all other engineering standards may be approved by the District Administrator or designee.***

For private sector project related crossover requests **that do not meet the spacing standards**, a spacing exception must be approved by the District Administrator or designee as described in the “Exceptions to the Spacing Standards” section above. Traffic studies as outlined above must accompany the request for a crossover location that does not meet the minimum spacing standards.

The approval of the addition or relocation of crossovers on an existing VDOT highway **that do not meet the sight distance requirements or other engineering standards** shall be the responsibility of the Regional Traffic Engineer with the concurrence of the State Location and Design Engineer. It shall be the responsibility of the Regional Traffic Engineer to coordinate such changes with the State Location and Design Engineer in order that these revisions of crossovers may be properly recorded on the original plans.

* Rev. 1/12

Highway Construction Project

As part of a highway construction project, crossover spacing less than shown as minimum in Tables 2-2 through 2-4, will be considered when required by existing intersecting public highways or streets with a current ADT of 100 or greater and must be submitted for approval to the District Location and Design Engineer using Form AM-3.* All plans at the public hearing stage are to show only those crossovers at public highways and streets which meet these criteria or at other locations that preliminary planning and traffic studies have warranted. The determination of additional crossover locations or closing of a crossover shall be the result of field inspection recommendations of the District Administrator and the Regional Traffic Engineer.

The approval of crossovers that do not meet engineering standards shall be the responsibility of the Regional Traffic Engineer and the State Location and Design Engineer, with the final responsibility for the location of crossover layout on plans resting with the State Location and Design Engineer. Plans at right-of-way stage are to indicate the crossovers as determined and approved by the above criteria. Any plans that are revised during construction for the addition or deletion of crossovers where spacing standards or engineering standards are not met shall be approved by the District Location and Design Engineer, the Regional Traffic Engineer, and/or the State Location and Design Engineer in accordance with the approval process outlined above.

Signalized and Unsignalized Intersection Design

At-grade intersections must provide adequately for anticipated turning and crossing movements.

For shoulder applications, Figures 2-11 and 2-12 provides the designer with the basic types of intersection designs and minimum dimensions, radii, skews, angles, and the types of island separations, etc.

For curb and gutter applications see AASHTO's A Policy on Geometric Design of Highways and Streets, Chapter 9 (Intersections). This chapter provides additional information to be considered in the design since the site conditions, alignment, grades, sight distance and the need for turning lanes and other factors enter into the type of intersection design.

Sufficient offset dimensions, pavement widths, pluses, and radii shall be shown in the plans by the designer to insure that the sign island is properly positioned.

Care should be taken in the design of four-lane roadways with intersecting two-lane roadways. If traffic conditions clearly warrant a four-lane divided design for the two-lane road at the intersection, the divided design must be constructed for a sufficient distance to allow for the approaching divided design and the subsequent stop condition ahead to be properly signed. The four-lane divided design should not be constructed unless it is clearly warranted and the approaches can be properly signed or the minor road is expected to be improved to a divided status in the near future.

Figures 2-11 and 2-12 are also applicable for intersection designs without sign islands.

* Rev. 7/11

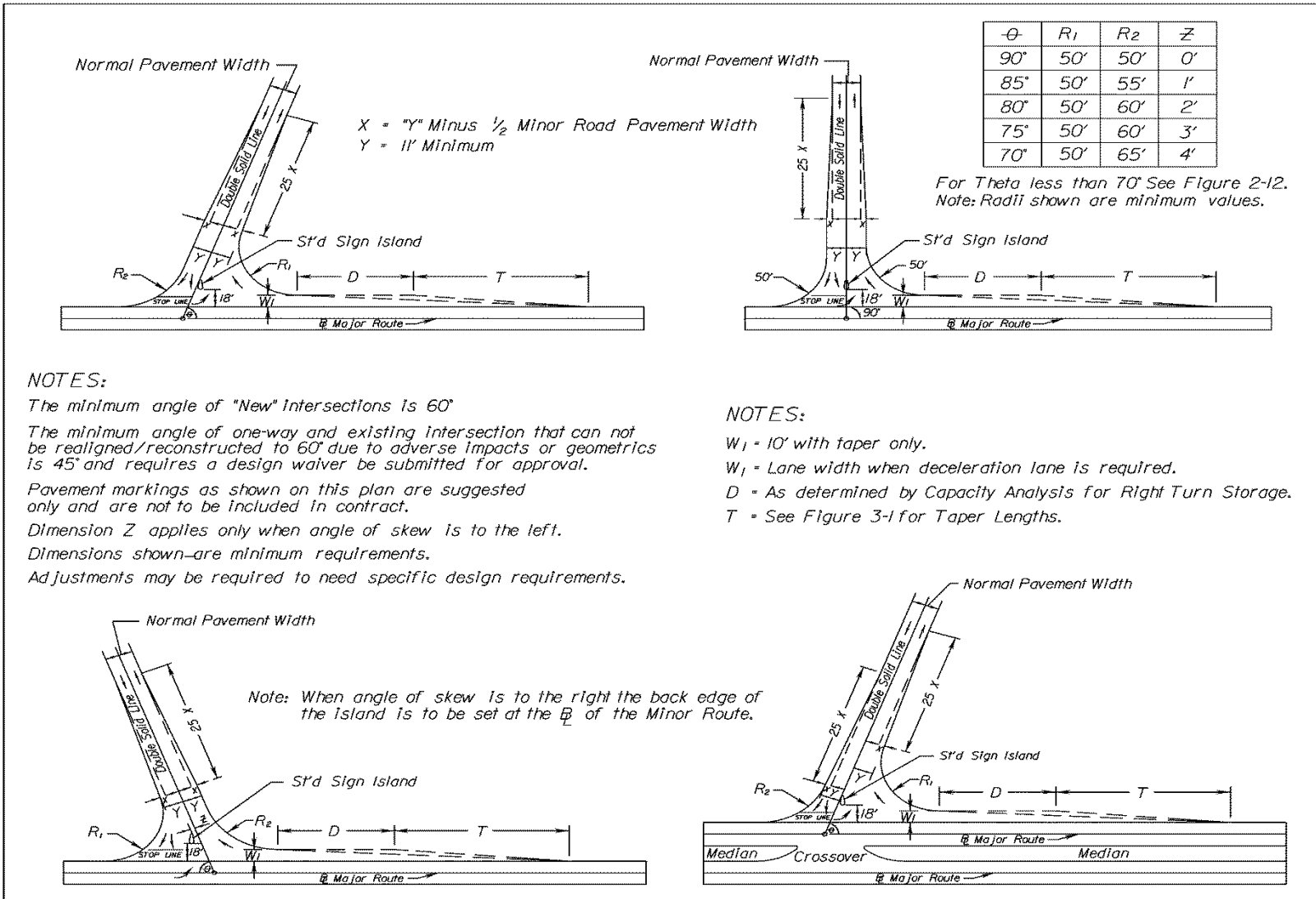

NOTES:

The minimum angle of "New" Intersections is 60°
 The minimum angle of one-way and existing intersection that can not be realigned/reconstructed to 60° due to adverse impacts or geometrics is 45° and requires a design waiver be submitted for approval.
 Pavement markings as shown on this plan are suggested only and are not to be included in contract.
 Dimension Z applies only when angle of skew is to the left.
 Dimensions shown are minimum requirements.
 Adjustments may be required to need specific design requirements.

NOTES:

W_1 = 10' with taper only.
 W_1 = Lane width when deceleration lane is required.
 D = As determined by Capacity Analysis for Right Turn Storage.
 T = See Figure 3-1 for Taper Lengths.

FIGURE 2-11 INTERSECTION DESIGN FOR RURAL APPLICATIONS WITH OR WITHOUT STANDARD SI-1 SIGN ISLAND DESIGN*

* Rev. 3/11

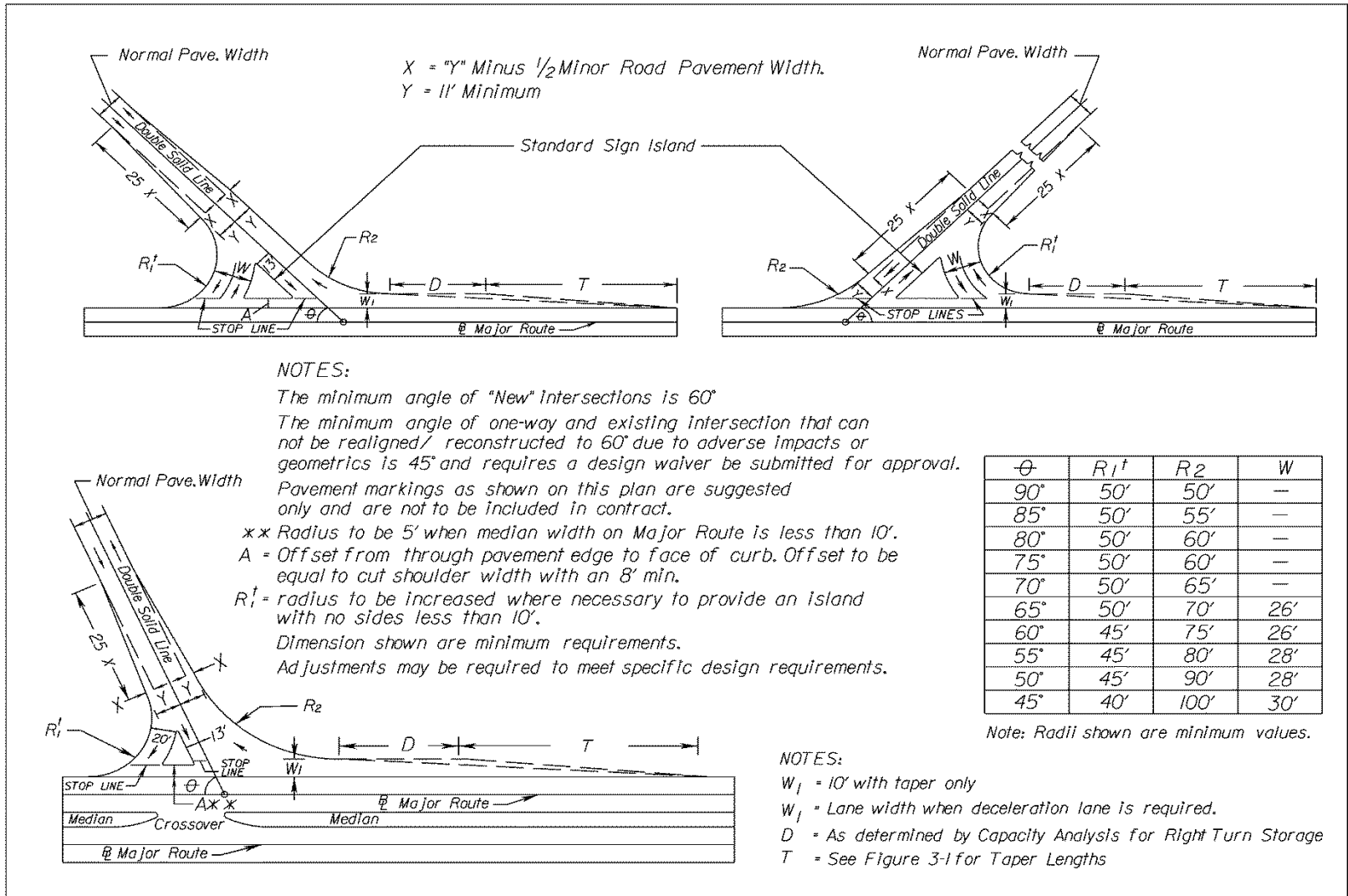

FIGURE 2-12 INTERSECTION DESIGN FOR RURAL APPLICATIONS WITH OR WITHOUT STANDARD SI-2 OR SI-3 SIGN ISLAND DESIGN*

* Rev. 3/11

Stopping Sight Distance

Stopping sight distances exceeding those shown in the table below should be used as basis for design wherever practical.

In computing and measuring stopping sight distances, the height of the driver's eye is estimated to be 3.5 feet and the height of the object to be seen by the driver is 2 feet, equivalent to the taillight height of a passenger car. The "K Values" shown are a coefficient by which the algebraic difference in grade may be multiplied to determine the length in feet of the vertical curve that will provide minimum sight distance. Crest vertical curves shall meet or exceed AASHTO design criteria for Stopping Sight Distance, not the "k" Values. Sag vertical curves shall meet or exceed the AASHTO design criteria for headlight sight distance and "k" Values.

Height of Eye 3.5'				Height of Object 2'							
Design Speed (mph) **	25	30	35	40	45	50	55	60	65	70	75
MIN. SIGHT DISTANCE (FT.)	155	200	250	305	360	425	495	570	645	730	820
MINIMUM K VALUE FOR:											
CREST VERTICAL CURVES	12	19	29	44	61	84	114	151	193	247	312
SAG VERTICAL CURVES	26	37	49	64	79	96	115	136	157	181	206

Source: 2004 AASHTO Green Book, pages 112, 113, 272 and 277

TABLE 2-5 STOPPING SIGHT DISTANCE

When a highway is on a grade, the sight distances in the table below should be used.

Design Speed (mph) **	Stopping Sight Distance on Grades					
	Downgrades			Upgrades		
	3%	6%	9%	3%	6%	9%
15	80	82	85	75	74	73
20	116	120	126	109	107	104
25	158	165	173	147	143	140
30	205	215	227	200	184	179
35	257	271	287	237	229	222
40	315	333	354	289	278	269
45	378	400	427	344	331	320
50	446	474	507	405	388	375
55	520	553	593	469	450	433
60	598	638	686	538	515	495
65	682	728	785	612	584	561
70	771	825	891	690	658	631
75	866	927	1003	772	736	704*

TABLE 2-6 STOPPING SIGHT DISTANCE ON GRADES

(See 2004 AASHTO Green Book, page 115)

* Rev. 3/11

Intersection Sight Distance

The following table shows intersection sight distance requirements for various speeds along major roads:

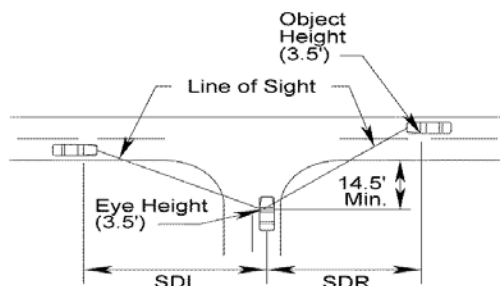

SDR = Sight Distance Right (For a vehicle making a left turn)
 SDL = Sight Distance Left (For a vehicle making a right or left turn)

Height of Eye 3.5'		Height of Object 3.5'									
Design Speed (mph)**	20	25	30	35	40	45	50	55	60	65	70
SDL=SDR: 2 Lane Major Road	225	280	335	390	445	500	555	610	665	720	775
SDR: 4 Lane Major Road (Undivided) or 3 Lane	250	315	375	440	500	565	625	690	750	815	875
SDL: 4 Lane Major Road (Undivided) or 3 Lane	240	295	355	415	475	530	590	650	710	765	825
SDR: 4 Lane Major Road (Divided – 18' Median)	275	340	410	480	545	615	680	750	820	885	955
SDL: 4 Lane Major Road (Divided – 18' Median)	240	295	355	415	475	530	590	650	710	765	825
SDR: 5 Lane Major Road (continuous two-way turn-lane)	265	335	400	465	530	600	665	730	800	860	930
SDL: 5 Lane Major Road (continuous two-way turn-lane)	250	315	375	440	500	565	625	690	750	815	875
SDR: 6 Lane Major Road (Divided – 18' Median)	290	360	430	505	575	645	720	790	860	935	1005
SDL: 6 Lane Major Road (Divided – 18' Median)	250	315	375	440	500	565	625	690	750	815	875
SDL: (Where left turns are physically restricted)	210	260	310	365	415	465	515	560	620	670	725

TABLE 2-7 INTERSECTION SIGHT DISTANCE*

Source: AASHTO Green Book (See Table 9-5 thru 9-14)

**For all tables, use design speed if available, if not use legal speed.

* Rev. 7/12

Note: Both SDR and SDL must be met at the intersection, unless left turns are physically restricted by a median or channelization island; then only SDL is needed. Intersection sight distance determinations apply both horizontally and vertically, measured in each direction, and are to be based on a height of driver's eye of 3.5' and a height of object 3.5'.*

The term "Major Road" refers to the road with the higher functional classification, or if both have the same classification, the road with the higher volume.

Intersection sight distance does not control the access spacing for entrances and intersections shown in Table 2-2.

For major roadways of more than four lanes, large truck volumes on a minor road or crossover, or median widths over 60', see AASHTO's A Policy on Geometric Design of Highways and Streets.

The designer must check each intersection to insure that adequate sight distance is provided. On a typical two-lane road horizontal curve there are numerous objects that restrict sight distance such as cut slopes, buildings, vegetation, vehicles, etc.

These obstructions should be considered when reviewing commercial entrances. A divided highway can have similar problems. It is very important to obtain adequate intersection sight distance for all "New" and "Reconstructed" commercial entrances from the entrance as well as the left turn position into the entrance. If the minimum intersection sight distance values in the table mentioned above cannot be met, a Design Waiver shall be requested in accordance with IIM-227, see 2011 AASHTO Green Book, Chapter 9 for further guidance. Design Waiver and Design Exception requirements are based on the following;

- 1) Design Waiver – Meets Stopping Sight Distance but not Intersection Stopping Distance.
- 2) Design Exception – Does not meet the minimum Stopping Sight Distance.

The Intersection Sight Distance values in the table above permit a vehicle stopped on a minor road or crossover, to cross the major road safely or merge safely in the case of turns.

The Intersection Sight Distance table above is based on the following criteria:

The AASHTO Green Book shows that it requires 7.5 seconds for a passenger car to turn left onto a two-lane road. For a passenger vehicle to turn right into the first lane, the Green Book shows that only 6.5 seconds is required because drivers making right turns generally accept gaps that slightly shorter than those accepted in making left turns.

The reference to 18' median in Table 2-7 applies to medians up to 18' in width (18' or less). For medians up to this width there is not sufficient room to stop so more sight distance is needed. For wider medians, there would be room to stop in the middle of the highway so sight distance can be less.

* Rev. 7/12

Median Openings/Crossovers

(With and Without Connections)

In commercial and industrial areas where property values are high and rights-of-way for wide medians are difficult to acquire, a paved flush traversable median 10' to 16' wide is the optimum design. The shape of the median end should generally be symmetrical when the median width is less than 10' and the median opening length is not excessive, but the bullet nose can be effectively used to reduce the opening. For a median width of 10' or more, the bullet nose design should be used instead of a semicircular design at 3-leg and 4-leg intersections.

The length of the crossover and the shape of the median end are controlled by the width of the median and the turning radii. A wide median opening can be reduced at skewed intersections by utilizing modifications of the bullet nose design. Additional information may be obtained from the Access Spacing Table 2-2 and AASHTO's A Policy on Geometric Design of Highways and Streets (Median Openings).

New crossovers must demonstrate that left-turn storage space is met. Use appropriate turning movement software for analysis (such as Auto-Turn).

Crossover Grades

On divided highways with depressed medians, there are generally three methods by which superelevation is determined for the opposing traffic lanes.

One method is for the median pavement edges to be held at the same, or close to the same elevation. A second method is for each baseline elevation to be approximately the same, with a corresponding difference in elevation of the median pavement edges. The third method is for the superelevation of all lanes to be obtained along a single plane. Thus, the grade of the lane on the outside of the curve is higher than the inside lane. The various methods are illustrated below.

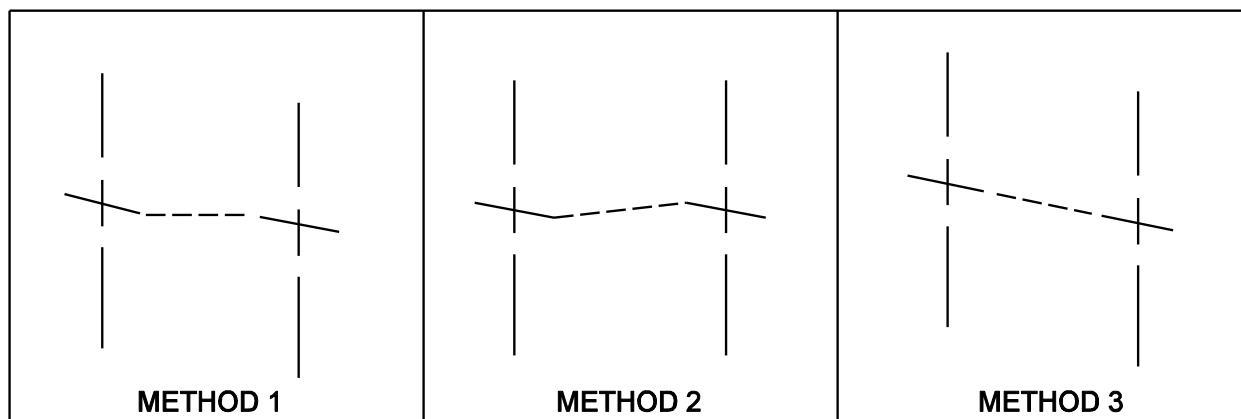

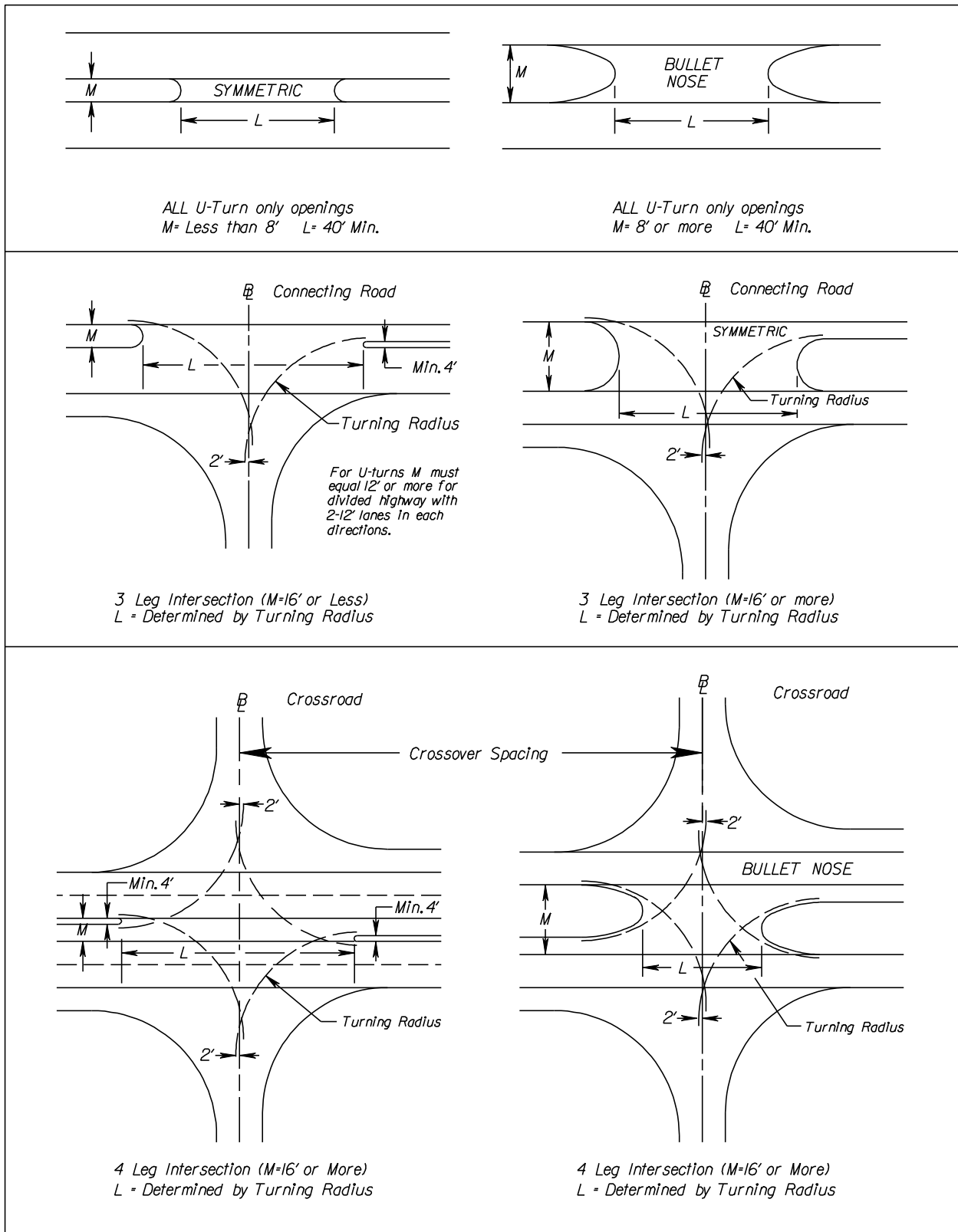

FIGURE 2-13 CROSSOVERS WITH AND WITHOUT CONNECTIONS

The designer is to study the requirements of each particular situation. In the case of a facility without crossovers, the first method above is generally acceptable on superelevated curves. This will allow the median area to be properly graded without creating an adverse design situation.

Method 2 generally results in an undesirable situation and must be used with caution.

In a case where a crossover is proposed, particularly in conjunction with a connecting road within the limits of a superelevated curve, the designer shall pay particular attention to the patch which must be traversed by vehicles using the crossover.

In most cases, the application of the superelevation in a single plane (Method 3) is the acceptable method. This will allow a vehicle to cross from one lane to the other without negotiating several different gradients. As noted, herein, this will require the adjustment of the mainline grades.

The desirable grade on a crossover is between 0.5% and 5%. The maximum grade should never exceed 10% as safe turning movements above this level are difficult. It is especially important at locations, such as truck stops and other businesses generating large vehicular traffic, that crossover grades fall in the category of less than 5%. A desirable maximum algebraic difference of a crossover crown line is 4 or 5 percent, but it may be as high as 8 percent at the locations where there are few trucks or school buses and low speeds.

Additionally, sight distances must be checked for values shown in the Table 2-7 Intersection Sight Distance.

Any deviation from these values is to be brought to the attention of the State Location and Design Engineer.

The grade on a crossover is measured from the edge of shoulder to the edge of shoulder, unless left turn lanes are provided, in which case the grade is applied from the edge of pavement of the left turn lanes to the edge of pavement of the opposite left turn lane. This is more clearly shown in the following diagram:

Determination of Grade on a Crossover



In preparing plans for field inspection, the gradient at each crossover is to be plotted graphically.

Intersecting Cross Road Grades

The grade of a connecting facility must be carefully studied when approaching an intersection where the mainline is superelevated. A smooth grade tie-in is desirable, with sufficient area on a relatively flat grade for a vehicle to stop before entering the main roadway. Also, when a connection is on the outside of a superelevated curve, the grade must be designed so that the connection is visible to a driver on the main roadway desiring to turn onto the connections.

Every attempt must be made to provide an adequate area for this vehicular stoppage, giving full consideration to the horizontal and vertical sight distances.

The desirable tie-in is one that is no steeper than the pavement cross slope whether this is superelevated or the normal crown. The maximum difference between the pavement cross slope and the approach road grade shall not exceed 8% at stop intersections or 4% at continuous-movement intersections. The stoppage area should be a minimum of 50' before beginning the steeper grade. (See AASHTO's A Policy on Geometric Design of Highways and Streets).

Roundabouts

Overview

Roundabouts are circular intersections with specific design and traffic control features. These include yield control of all entering traffic (circulating vehicles have the right-of-way), channelized approaches, and geometric curvature to ensure that travel speeds are typically less than 30 mph (single lane 20-25 mph; double lane 25-30 mph).

Roundabouts are generally safer than other types of intersections for low and medium traffic conditions. These safety benefits are achieved by eliminating vehicle crossing movements through the conversion of all movements to right turns and by requiring lower speeds as motorists proceed into and through the roundabout. The potential for right angle and left turn head-on crashes is eliminated with single lane roundabouts. Single lane roundabouts are safer than double lane roundabouts due to more complex decisions for entering and especially for exiting a double lane roundabout.

While roundabouts usually require more right-of-way area at an intersection, compared to a traffic signal, they require less right-of-way area on the upstream approaches and downstream exits. At new intersection sites that will require turn lanes a roundabout can be a less expensive intersection alternative. Operating and maintenance costs are less than signalized intersections since there is no signal equipment. The roundabout has aesthetic advantages over other intersection types particularly when the center island is landscaped.

Because roundabouts treat all vehicle movements equally (each approach is required to yield to circulating traffic), a roundabout that will serve the intersection of a higher volume major roadway and a lower volume minor street (e.g. principal arterial vs. collector) can cause traffic delays and stopped queues on the major roadway. Consequently, functional classification (hierarchy) of the intersecting roads needs to be assessed when considering the construction of a roundabout.

VDOT Policy

VDOT recognizes that roundabouts are frequently able to address the above safety and operational objectives better than other types of intersections in both urban and rural environments and on high-speed and low-speed highways.

Therefore, it is VDOT policy that roundabouts be considered when a project includes reconstructing or constructing new intersection(s), signalized or unsignalized. As a minimum, the roundabout alternative shall be reviewed to determine conceptual project impacts including safety, land impacts and construction. If the roundabout appears to be a feasible alternative, then a traffic analysis and preliminary layout should be created and analyzed in further detail. In such case the Engineer shall provide an analysis of each intersection to determine if a roundabout is a feasible alternative based on site constraints, including right-of-way, environmental factors and other design constraints. The advantages and disadvantages of constructing a roundabout shall be documented for each intersection.

When the analysis shows that a roundabout is a feasible alternative, it is considered the Department's preferred alternative due to the proven substantial safety and operational benefits.

Roundabouts should not be considered as a feasible alternative when the following criteria exist:

- Where adequate horizontal and/or vertical approach sight distances cannot be met.
- When there are signalized intersections close to the proposed roundabout.
- Where high volume entrances are in close proximity (within 100') to the outer edge of the inscribed diameter.
- Where left turns are not the predominant turning movement.
- When deemed unsuitable due to other engineering factors by the District or Central Roundabout Review Committee.

Design/Resources

The maximum daily service volume of a single-lane roundabout varies between 20,000 and 26,000 vehicles per day (2,000 -2,600 peak hour volume), depending on the left turn percentages and the distribution of traffic between the major and minor roads.

Roundabout designs shall be based on **NCHRP Report 672**, Roundabouts: An Informational Guide, **Second Edition***. See the following link:

http://onlinepubs.trb.org/onlinepubs/nchrp/nchrp_rpt_672.pdf.

Additional information can also be found in VDOT's Roundabout Brochure at <http://www.virginia-dot.org/info/resources/Roundabouts.pdf> and on VDOT's roundabout web site at [Roundabouts in Virginia](#).

* Rev. 7/11

Spacing standards for Roundabouts are presented in Table 2-2 and the notes listed under the table.

Figure 2-14 illustrates roundabout design details including pedestrian and bicycle treatments. Common characteristics of acceptable roundabouts include a

- Domed center that is sufficiently clear to not compromise sight distance, and
- Paved traversable apron not less than 4 feet in width, the radius of which is sufficient to serve the turning radius of school buses and single unit design vehicles. If the percentage of trucks anticipated to use the road exceeds 5%, that radius should be sufficient to serve those vehicles.

Example Plan Sheets for Typical Single Lane Roundabouts can be accessed at:

<https://www.nysdot.gov/portal/page/portal/main/roundabouts/guide-engineers/examples>

The documentation shall include, at a minimum, the criteria outlined in this chapter.

When roundabout design is proposed, the District Location & Design Engineer should be consulted.

The Approval Process for Roundabouts

Existing and Proposed Subdivisions - The District may review and approve roundabouts in subdivisions.

Secondary System – The District may approve up to a traffic design volume of 10,000 VPD. Roundabout designs in which the counts are beyond this volume should be submitted to the Central Office Roundabout Review Committee for review. The committee will make recommendations to the State Location and Design Engineer for approval or disapproval. Appeals of the State Location and Design Engineer decision will go to the Chief Engineer for resolution.

When a District receives a request for a roundabout from an outside entity, and the design volume is under 10,000 VPD but desires Roundabout Committee review and input, the submittal may be sent to the State Location and Design Engineer. It will be reviewed and comments and/or recommendations will be returned in a timely manner.

Primary or Urban System - The District will submit roundabout designs to the Central Office Roundabout Committee for review. The approval and appeals will be the same as used above for these roadway systems with one exception: urban systems will require approval of the Local Assistance Division Administrator as well as the State Location and Design Engineer.

The process listed above applies to:

- Roundabouts proposed through 6 year construction program.
- Roundabouts proposed during road safety improvements and/or upgrades.
- Roundabouts proposed by Counties, Localities, Consultants and Developers.

The submittal should contain and depict the following criteria:

- Approach Grades and sight distances.
- Inscribed diameter of circulatory roadway.
- Design vehicle (WB-50 or WB-67).
- Apron width, circulatory lane width and approach lane widths.
- Approach lane deflection and length of splitter islands.
- Pedestrian crossing locations.
- Pavement markings.
- Signing.
- Roadway Lighting (desirable).
- Nearest entrance locations and nature of property use.
- Initial or present and projected design year traffic count on all approaches.
- Turning movements for all directions.
- VISSIM or SIDRA Analysis on all approaches showing peak hour LOS in design year.
- Autoturn results showing off tracking of Design Vehicle.
- Is this facility designed as a bicycle Route?
- Are there* accommodations made for bicyclists?

If for some reason, the District does not have capability to run the subject computer programs, the Roundabout Committee can provide assistance upon request.

* Rev. 7/12

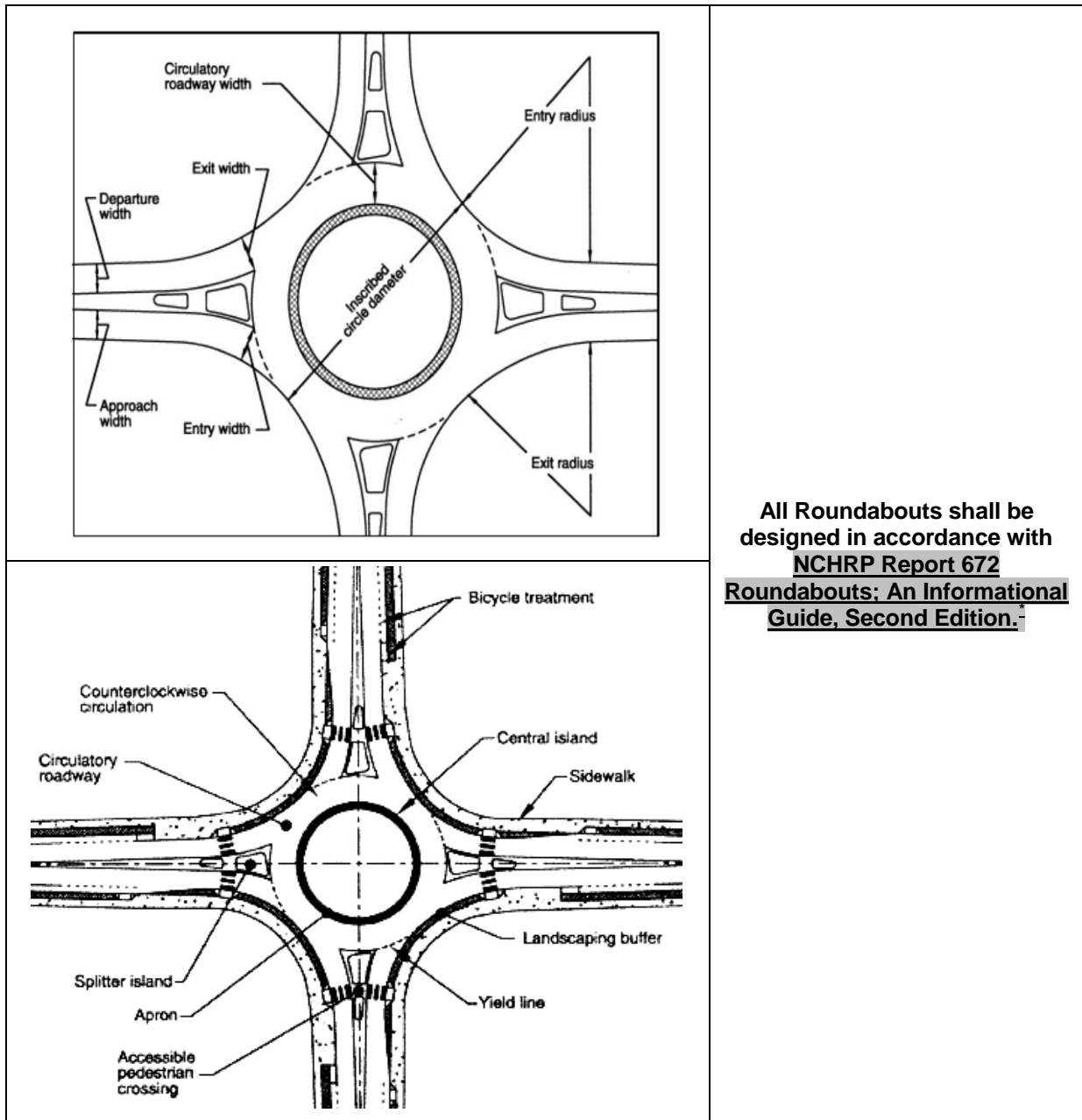

All Roundabouts shall be designed in accordance with NCHRP Report 672 Roundabouts: An Informational Guide, Second Edition.

FIGURE 2-14 ROUNDABOUT DESIGN DETAILS

* Rev. 1/12

Accommodating Pedestrians and Bicyclists

According to the Commonwealth Transportation Board's adopted [Policy for Integrating Bicycle and Pedestrian Accommodations](#), bicycling and walking are fundamental travel modes and integral components of an efficient transportation network. Appropriate bicycle and pedestrian accommodations provide the public, including the disabled community, with

- Access to the transportation network;
- Connectivity with other modes of transportation; and
- Independent mobility regardless of age, physical constraints, or income.

Effective bicycle and pedestrian accommodations enhance the quality of life and health, strengthen communities, increase safety for all highway users, reduce congestion, and can benefit the environment. Bicycling and walking are successfully accommodated when travel by these modes is efficient, safe, and comfortable for the public. It is important that the consideration and provision of bicycling and walking accommodations be consistently incorporated into the decision-making process for Virginia's transportation network.

The VDOT web site contains a number of resources on accommodating pedestrian and bicycle facilities as well as facility design guidelines.

VDOT's Designated Bicycle and Pedestrian Accommodations provides design standards for bicycle and pedestrian facilities (e.g. designated bicycle lanes at least 4 feet in width, providing striping for bicycle lanes, asphalt or concrete sidewalks at least 5 feet in width, pedestrian islands at intersections and roundabouts).

[Bicycle Facility Guidelines \(web link\)](#) are presented in Section A-5, Appendix A of The Road Design Manual. [Section 2E-3](#) of this Manual also provides [Sidewalk Design Standards \(web link\)](#) on sheet 7 in the Location & Design Division Instructional and Informational Memorandum IIM-LD-55.11.

[Standards for Intersection Crosswalk Markings \(web link\)](#) can be found on page 3B-27 in the Manual for Uniform Traffic Control Devices and [Standards for Pedestrian and Bicycle Markings for Roundabouts \(web link\)](#) are described on pages 3B-44 and 3B-45.

Figure 3-25 offers a basic illustration of these pedestrian and bicycle concepts along a highway corridor and at an intersection.

An Internal Bicycle and Pedestrian Task Force is responsible for ensuring consistent implementation of bicycle and pedestrian policies within VDOT, while the Bicycle Accommodations Review Team evaluates proposed plans to ensure consistency in bicycle and pedestrian facility design. For additional information see the [State Bicycle and Pedestrian Program](#) web page on the VDOT web site.

Managing Access to the Highway and Pedestrian/Bicyclist Safety

Numerous entrances and intersections create safety problems for pedestrians and bicyclists. Every entrance and intersection creates pedestrian-vehicle, bicyclist-vehicle and vehicle-vehicle conflicts. Pedestrians and bicyclists are especially vulnerable to vehicular left turns because they are small visual objects compared to vehicles and not clearly visible to drivers who are focusing on the opposing traffic when they begin a left turn. Left turns account for a high number of crashes with bicyclists and pedestrians.

Reducing the number of entrances and limiting access from one or more directions improves pedestrian and bicyclist safety:

- The number of conflict locations is minimized;
- Lowering the driver workload, as well as that of pedestrians and bicyclists, improves safety and simultaneously improves traffic flow.
- Pedestrian/bicyclist crossing is enhanced with median refuge areas; and
- Accommodating the disabled is easier, as the need for special treatments at entrances is reduced.

Figure 2-15 below illustrates how each entrance creates eight potential conflict points for pedestrians and bicyclists. Reducing the number of entrances and restricting left turn movements lowers these potential crash points.

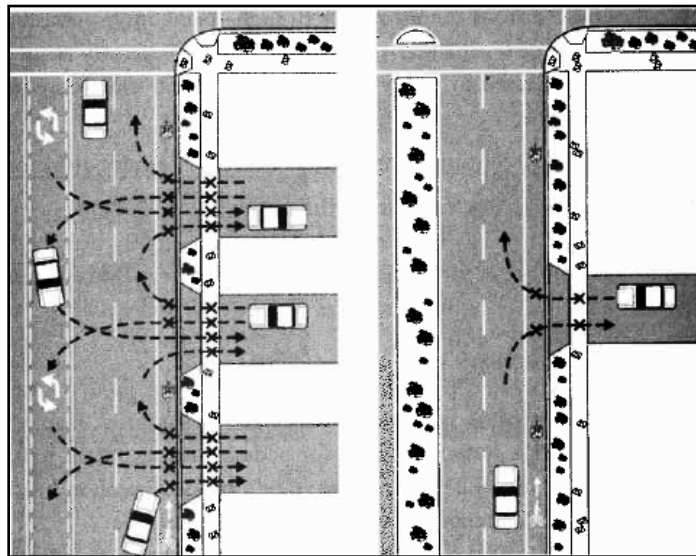

FIGURE 2-15 REDUCING THE NUMBER OF ENTRANCES BENEFITS PEDESTRIANS AND BICYCLISTS

Source: Transportation & Land Development 2nd Edition 2003, Koepke and Stover

Once the pattern of entrances and intersections is established, it is difficult to retroactively reduce, consolidate, or eliminate existing entrances to make existing roads more attractive to bicyclists and pedestrians.

However, mid-block crosswalks can be considered to provide locations for pedestrians and bicyclists to cross arterials between intersections where pedestrian/bicyclist attractors are located on opposite sides of a roadway. Mid-block crossings can provide:

- Visual cues to allow approaching motorists to anticipate pedestrian activity and unexpected stopped vehicles, and
- Reasonable opportunities to cross during heavy traffic periods, when there are few natural gaps in the traffic streams.

A traffic engineering investigation study will need to evaluate the proposed location and design. Conditions to examine include: sight distance, speeds, volumes, crash experiences, illumination, number and type of pedestrians, and the location of pedestrian generators. Design considerations include median refuge area, pavement markings, advance warning signs for vehicular traffic, and coordinating potential pedestrian/bicyclist activated crossing signals with the traffic signal timing on the highway so as to not interfere with traffic progression.

The Federal Highway Administration's web site contains a variety of research reports on techniques for improving pedestrian and bicyclist safety along the highway:

<http://www.fhrc.gov/safety/pab.htm>.

References for Section 2: Intersections

1. "Highway Capacity Manual" Special Report 209, Transportation Research Board, National Research Council, Washington, D.C. (2000).
2. Manual of Uniform Traffic Control Devices for Streets and Highways, Federal Highway Administration, Washington, D.C. (2003).
3. Levinson, H.S. "The Capacity of Shared Left Turn Lanes" Transportation Research Record 1225. Transportation Research Board, National Research Council, Washington, D.C. (1989).
4. Roundabouts: An Informational Guide, Federal Highway Administration, Washington D.C. (2000).
5. Stover, V.G. and Koepke, F., Transportation and Land Development, Institute of Transportation Engineers, Washington, D.C. (2002).

SECTION 3 – TURNING LANES

Turn Lane Criteria for Single and Dual Lanes

As a general policy, left-turn lanes are to be provided for traffic in both directions in the design of all median crossovers on non-access controlled four-lane or greater divided highways using controls as shown in Figure 3-1 and adjusted upward as determined by Figure 3-3 or by capacity analysis for left-turn storage.

Left-turn lanes should also be established on two-lane and four lane undivided highways where needed for storage of left-turn vehicles and/or prevention of thru-traffic delay as shown in Figure 3-1 and adjusted upward as determined by Table 3-1 and Figure 3-5 through 3-22 or by capacity analysis for left-turn storage.

LENGTH OF STORAGE		TAPER - Rural and Urban	
Rural - For Design Speeds 50 MPH or Higher	*L - 200' min. (For 240 or fewer vehicles during peak hour, <u>making turn</u>)	- For Design Speeds 35 MPH or Higher	**T - 200' Min.
Rural - For Design Speeds 45 MPH or Less	*L - 100' min. (For 60 or fewer vehicles during peak hour, <u>making turn</u>)	- For Design Speeds 30 MPH or Less	**T - 100' Min. (single) **T - 200' Min. (dual)
*Distance L to be adjusted upward as determined by capacity analysis for Left and Right Turn Storage.		**Tapers are to be straight-line unless local policy requires reverse curves. In congested areas the taper length may be reduced to increase storage length. However, a design waiver shall be required.	
Urban - Length determined by capacity analysis for Left and Right Turn Storage		- For Design Speeds 50 MPH or Higher	**T - 200' Min.
		- For Design Speeds 45 MPH or Less	**T - 100' Min. (single) **T - 150' Min. (dual)

FIGURE 3-1 TURN LANE CRITERIA FOR SINGLE AND DUAL LANES

Taper rates: Rural - 8:1 for design speeds up to 30 mph and less, 15:1 for design speeds 35 mph and greater. Urban - 8:1 for design speeds up to 45 mph and less, 15:1 for design speeds 50 mph and greater. For urban dual lane taper (150' min.), See 2011 AASHTO Green Book, Chapter 9.

Note: Taper lengths shown above were compiled using these formulas and were rounded up.

* Rev. 7/12

For Four-Lane Highways

*Dimension "L" to be adjusted upward as determined by Figure 3-3 or by capacity analysis for left-turn storage lanes on four-lane or greater (divided) highways.

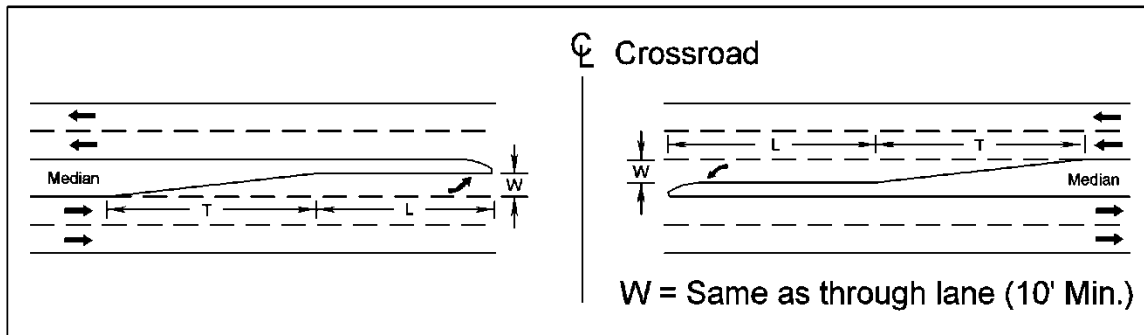

FIGURE 3-2 LEFT AND RIGHT TURN STORAGE AND TAPER LENGTHS

For Two-lane Highways

Dimension "L" to be adjusted upward as determined in Figures 3-5 through 3-22 or by a capacity analysis for left-turn storage. A capacity analysis is defined as a detailed analysis of the location in accordance with the guidelines contained in the current issue of the Highway Capacity Manual for intersection capacity and signalization requirements.

In general, when left-turn volumes are higher than 100 VPH, an exclusive left-turn should be considered.

Dual left-turn lanes should be considered when left turn hourly volumes exceed 300 VPH.

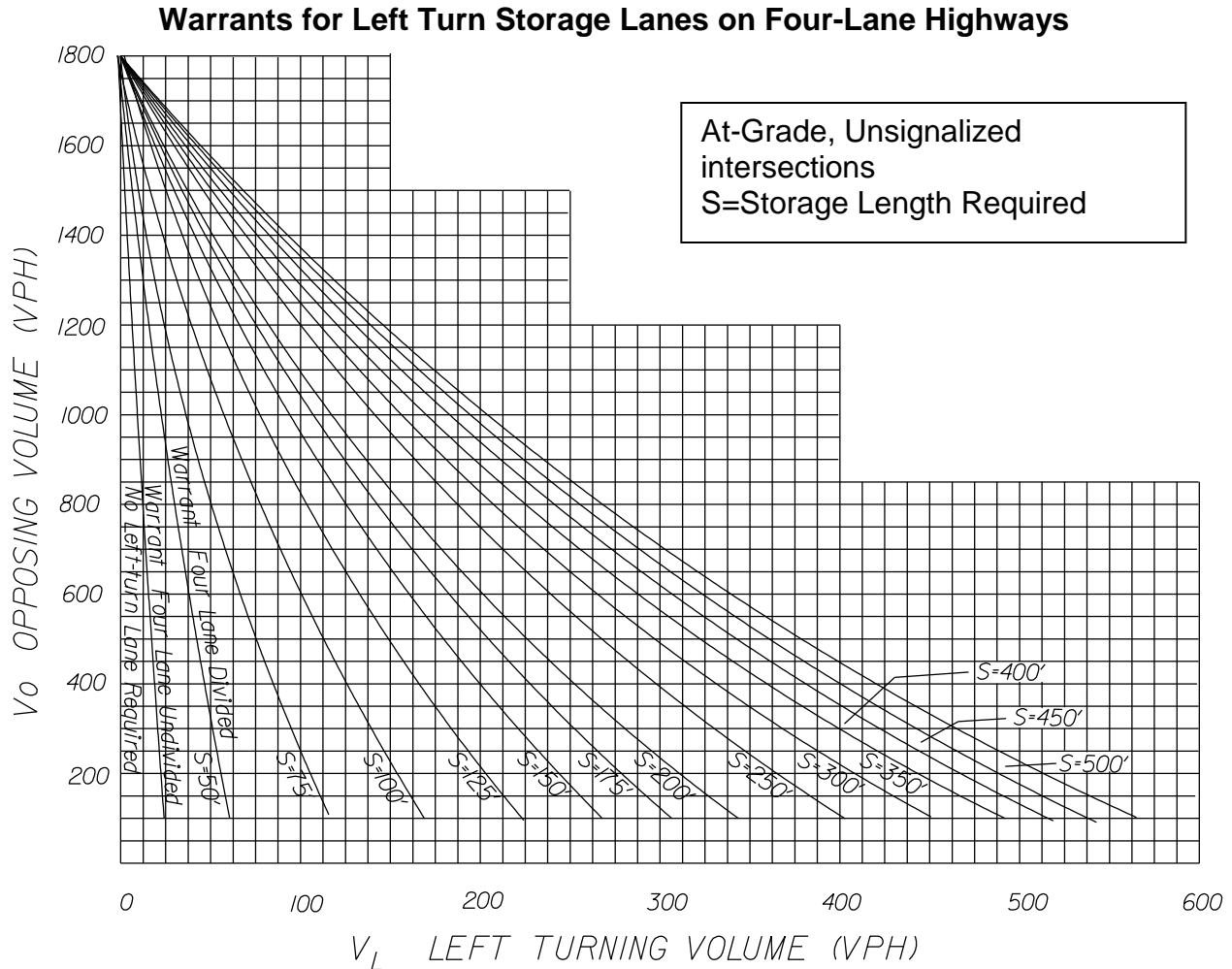

Figure 3-3 was derived from Highway Research Report No. 211.

When the Average Running Speed on an existing facility is available, the corresponding Design Speed may be obtained from [IIM LD- 117](#).

For plan detail requirements when curb and/or gutter are used, see VDOT's Road Design Manual, [Section 2E-3](#) on the VDOT web site:

<http://www.virginiadot.org/business/locdes/rdmanual-index.asp>.

Left-turn lanes should also be established on two-lane highways where traffic volumes are high enough to warrant them.

Warrants for Left Turn Storage Lanes on Two-Lane Highways

The warrants in table below are taken from the 2011 AASHTO “Green Book”, Page 9-132, Table 9-23. They were derived from Highway Research Report No. 211, Figures 2 through 19, for required storage length determinations.

The No. 211 study was undertaken to provide consistent volume warrants for left-turn storage lanes at unsignalized intersections.

WARRANTS FOR LEFT TURN LANES ON TWO-LANE HIGHWAYS

VPH OPPOSING VOLUME	ADVANCING VOLUME			
	5% LEFT TURNS	10% LEFT TURNS	20% LEFT TURNS	30% LEFT TURNS
	40-MPH DESIGN SPEED*			
800	330	240	180	160
600	410	305	225	200
400	510	380	275	245
200	640	470	350	305
100	720	515	390	340
	50-MPH DESIGN SPEED*			
800	280	210	165	135
600	350	280	195	170
400	430	320	240	210
200	550	400	300	270
100	615	445	335	295
	60-MPH DESIGN SPEED*			
800	230	170	125	115
600	290	210	160	140
400	365	270	200	175
200	450	330	250	215
100	505	370	275	240

TABLE 3-1

Source: Adapted from 2011 AASHTO Green Book, Page 9-132, Table 9-23*

* USE DESIGN SPEED IF AVAILABLE, IF NOT USE LEGAL SPEED LIMIT.

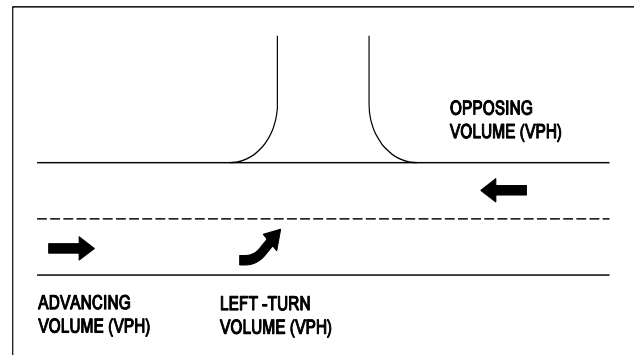

Example:

Two-lane highway with 40-MPH operating speed

Opposing Volume (VPH) - 600
 Advancing Volume (VPH) - 440
 Left-Turn Volume (VPH) - 44 or 10% of Advancing Volume

With opposing volume (VPH) of 600 and 10% of advancing volume (VPH) making left turns, and advancing volume (VPH) of 305 or more will warrant a left-turn lane.

* Rev. 7/12

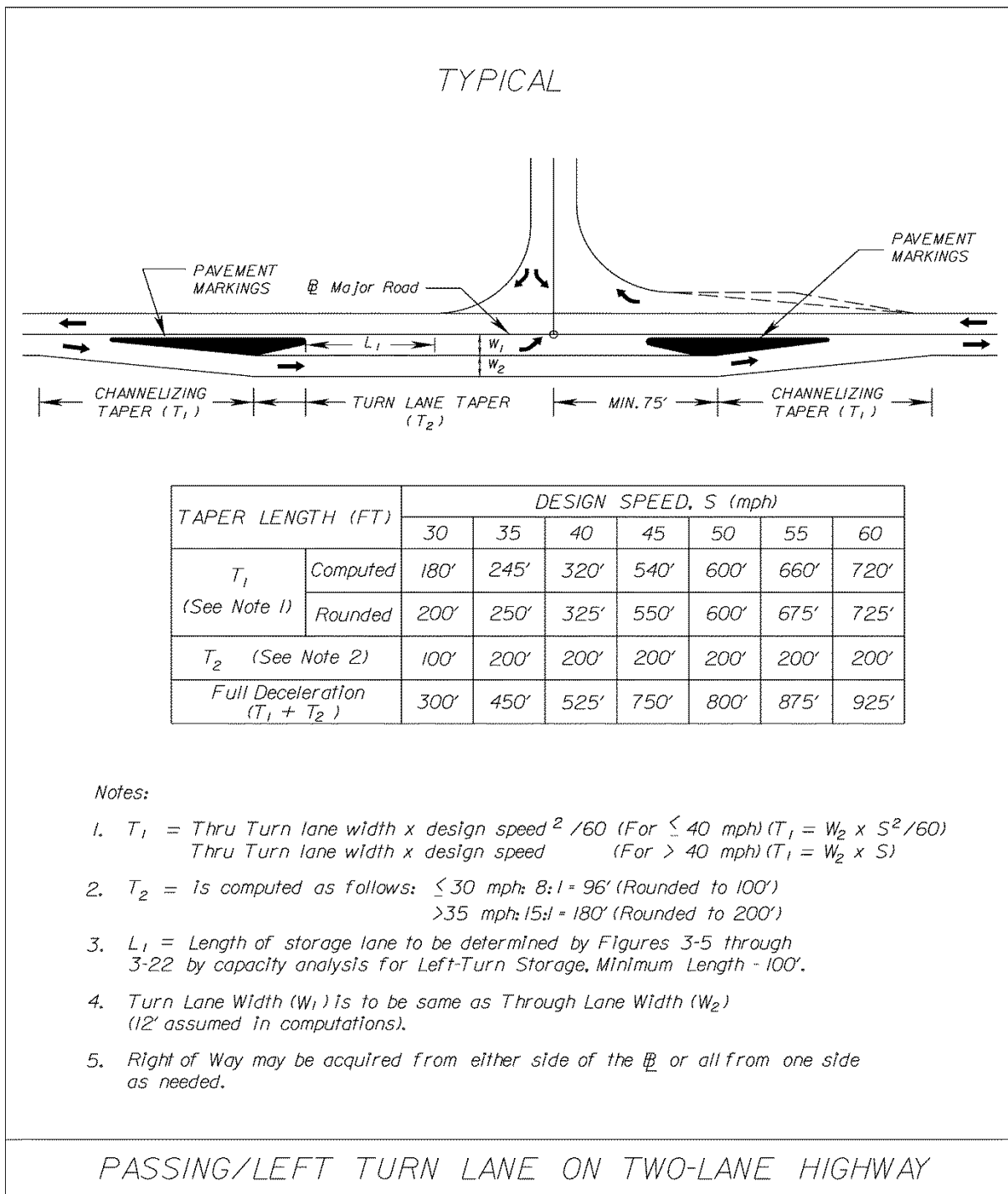

Source: 2003 MUTCD Chapter 6, Page 6C-8, Table 6C-4 (Formulas for Determining Channelizing Taper Lengths). Found at the following:
<http://www.virginiadot.org/business/bu-mutcd-disclaim.asp>
 AASHTO Green Book, Chapter 9 (For turning lane tapers).

FIGURE 3-4 PASSING/LEFT TURN LANE ON TWO-LANE HIGHWAY*

* Rev. 1/11

Figures 3-5 through 3-22 provide warrants for left-turn storage lanes on two-lane highways based on 5 to 30 percent left-turn volumes and design speeds of 40, 50, and 60 MPH. Additional storage length is required for 10 to 50 percent truck volumes.

Intersections with poor visibility and/or a bad accident record may require the designer to use engineering judgment when volume conditions alone do not warrant a storage lane.

Additionally, the functional classification of the highway shall be considered so that the impact of turning movements on highways intended to serve through traffic is minimized.

* **LANE/TRANSITIONS, MERGING TAPERS AND SPEED CHANGE LENGTHS**

Lane/transitions typically occur where new or reconstructed roadways tie-in to existing roadways. Lane transitions, merging tapers and speed change lengths shall meet the minimum length provided by the following equations:

Less than 45 mph

$$L = S^2W \div 60$$

45 mph and greater

$$L = W \times S$$

L = length of transition

S = Design Speed

W = Width of offset on each side

Transition length area shall include all roadside safety apparatus, if required.

WARRANT FOR LEFT-TURN STORAGE LANES ON TWO-LANE HIGHWAY

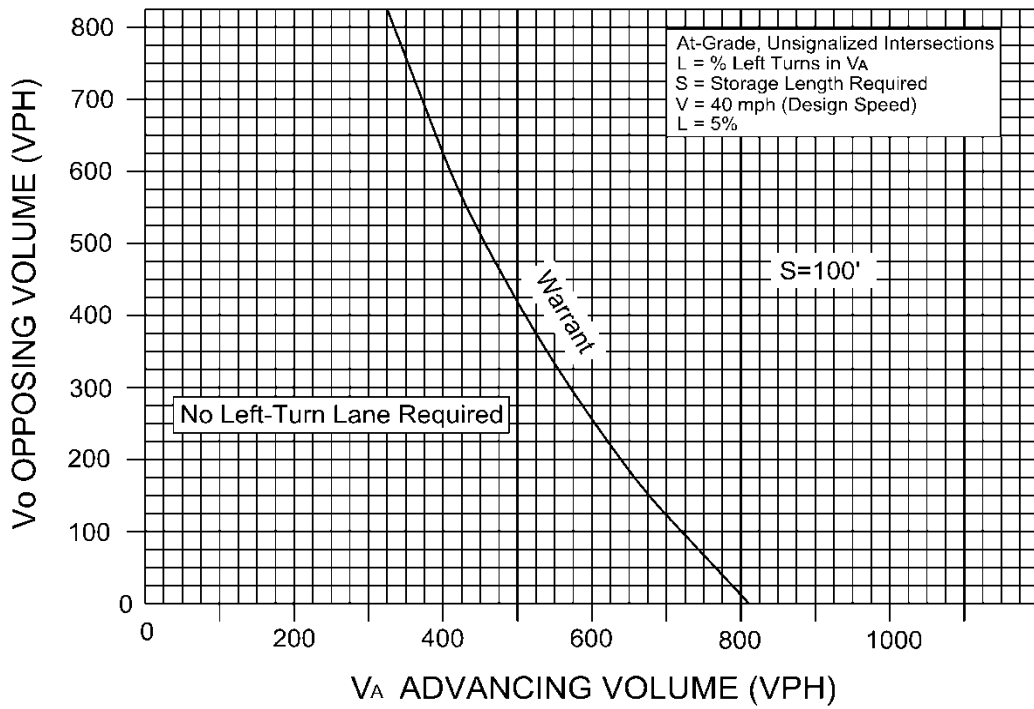

FIGURE 3-5

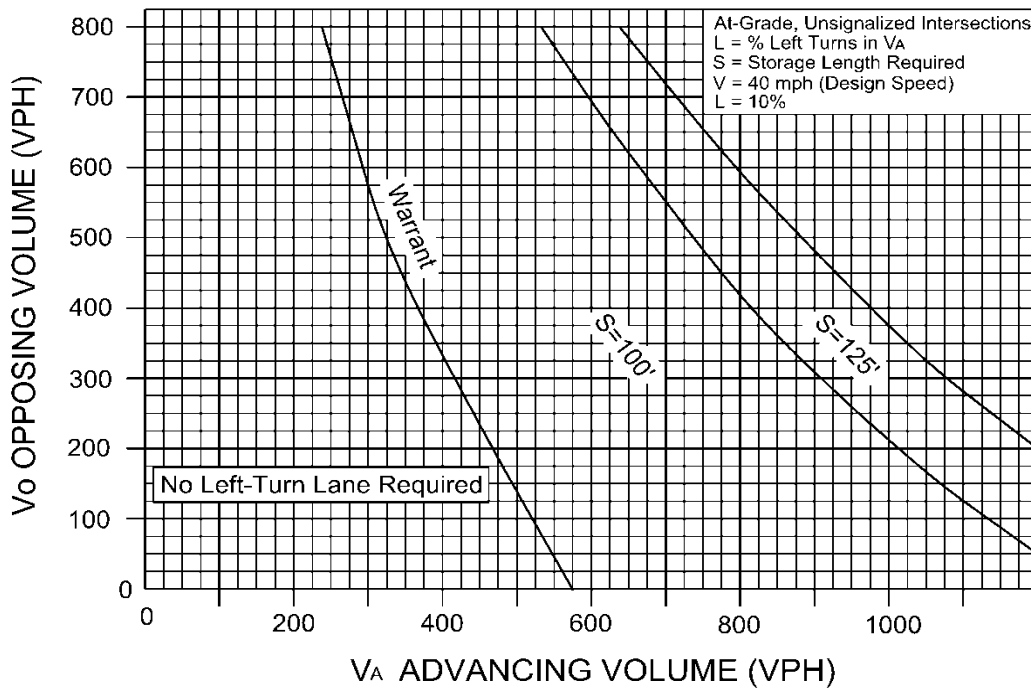

FIGURE 3-6

WARRANT FOR LEFT-TURN STORAGE LANES ON TWO-LANE HIGHWAY

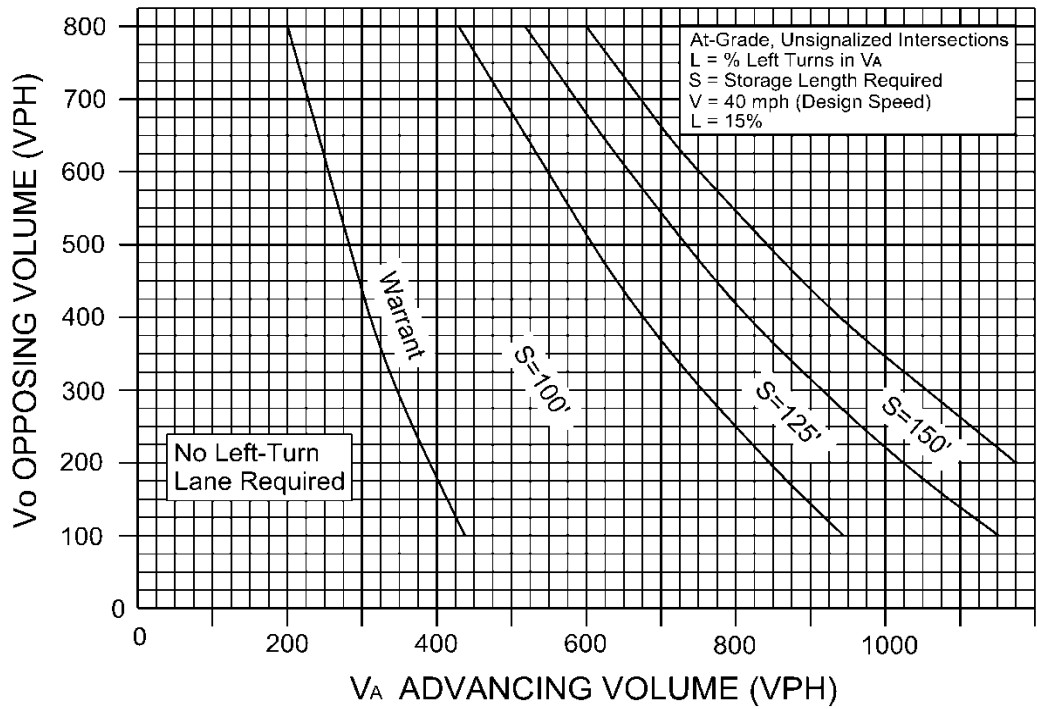

FIGURE 3-7

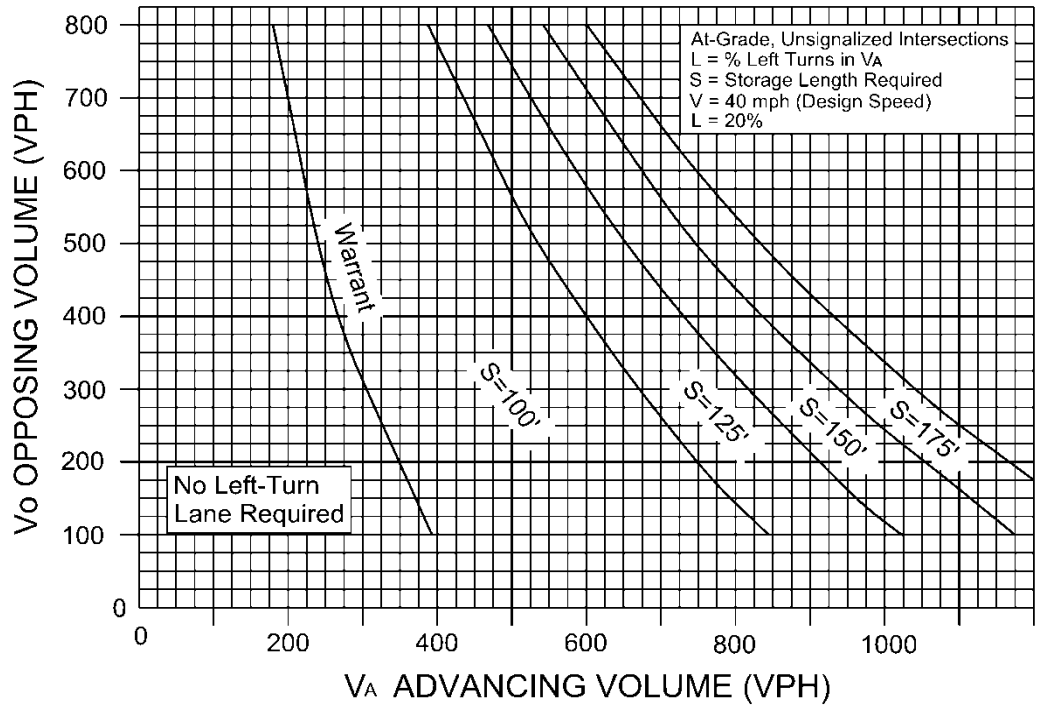

FIGURE 3-8

WARRANT FOR LEFT-TURN STORAGE LANES ON TWO-LANE HIGHWAY

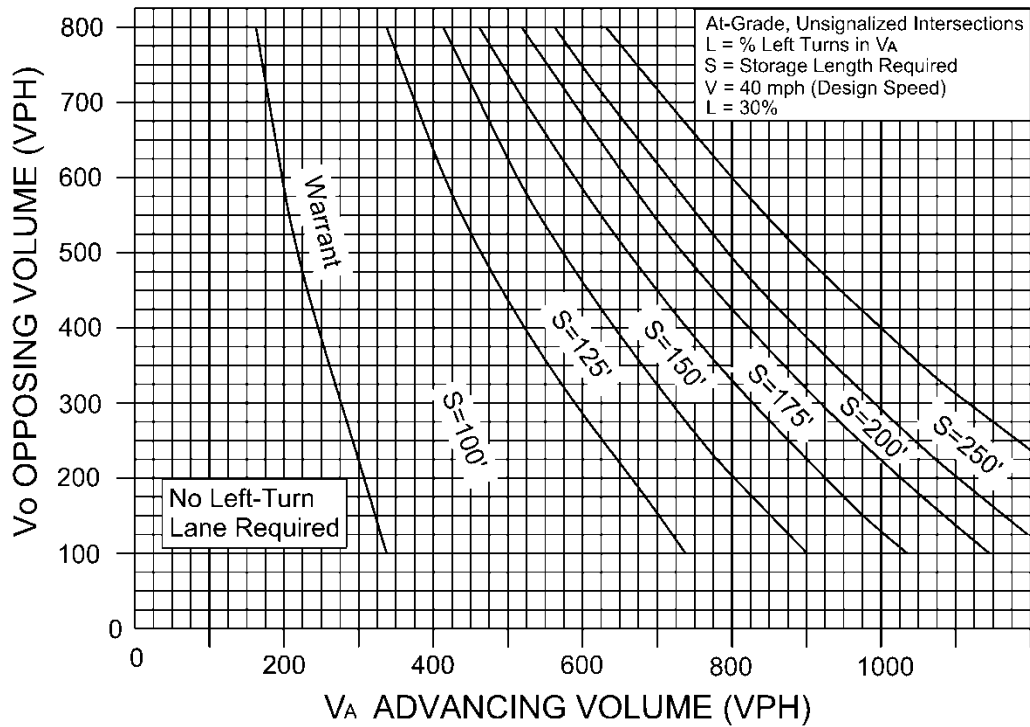

FIGURE 3-9

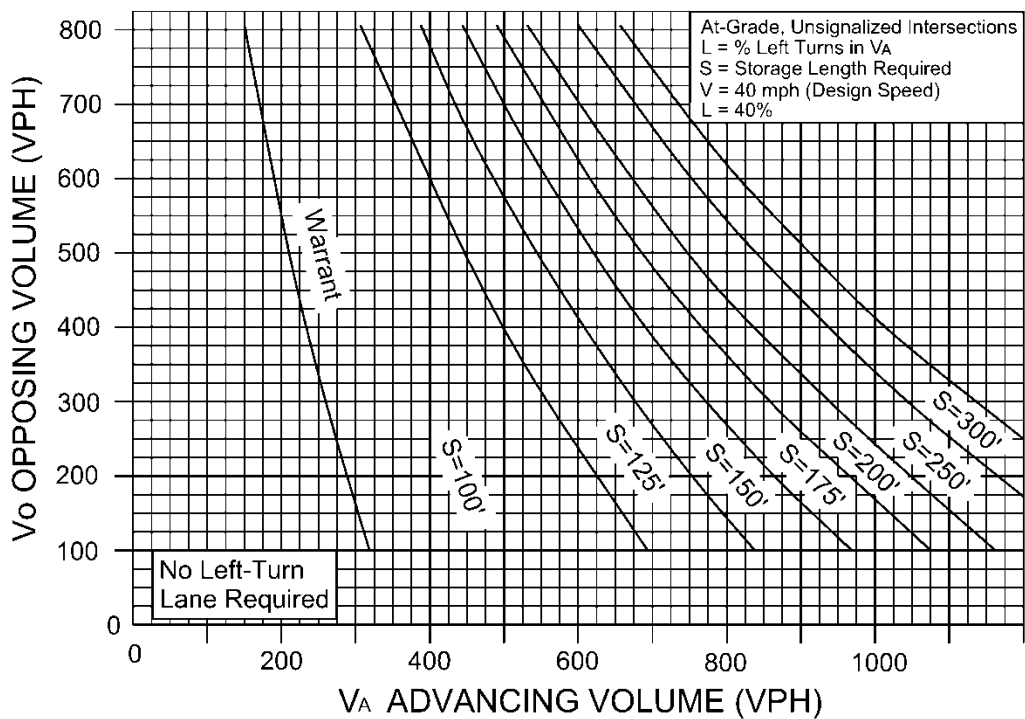

FIGURE 3-10

WARRANT FOR LEFT-TURN STORAGE LANES ON TWO-LANE HIGHWAY

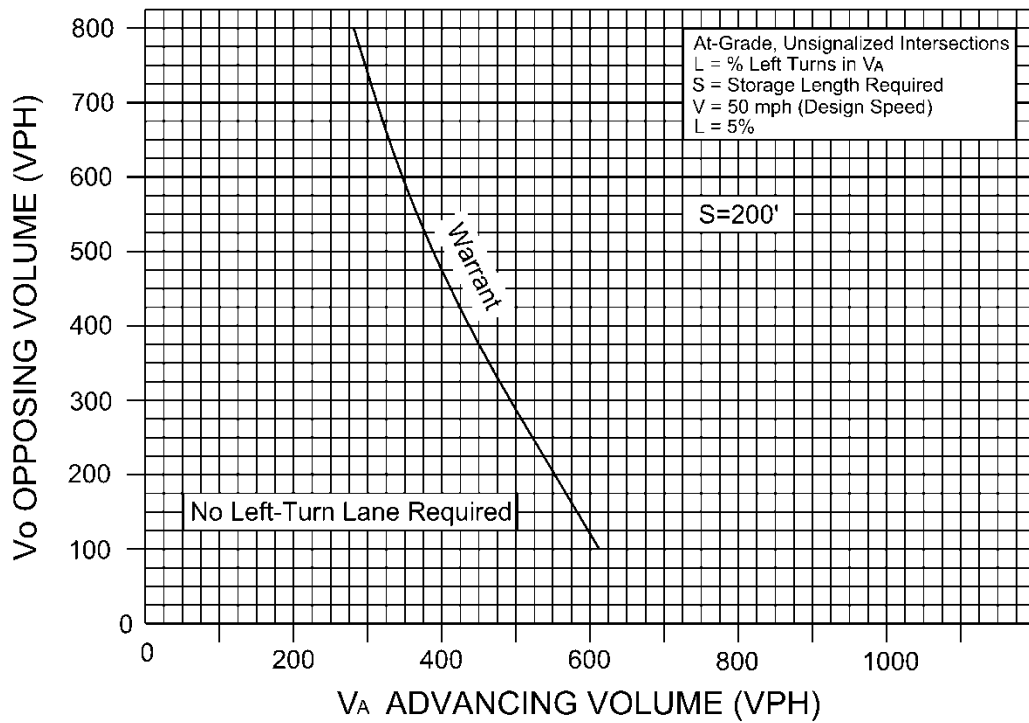

FIGURE 3-11

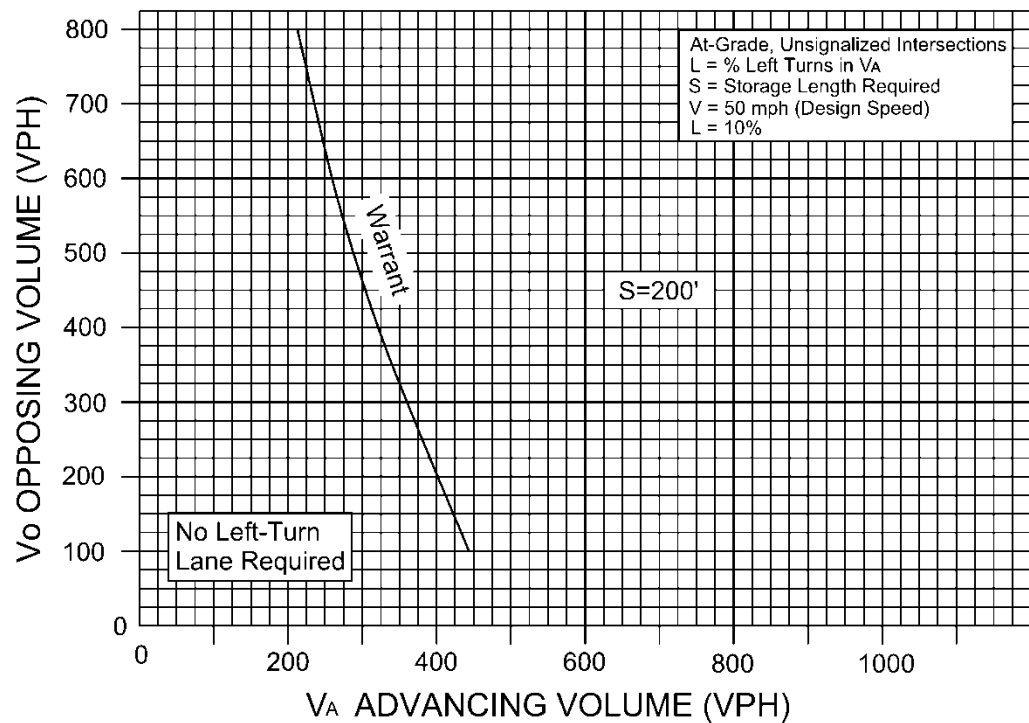

FIGURE 3-12

WARRANT FOR LEFT-TURN STORAGE LANES ON TWO-LANE HIGHWAY

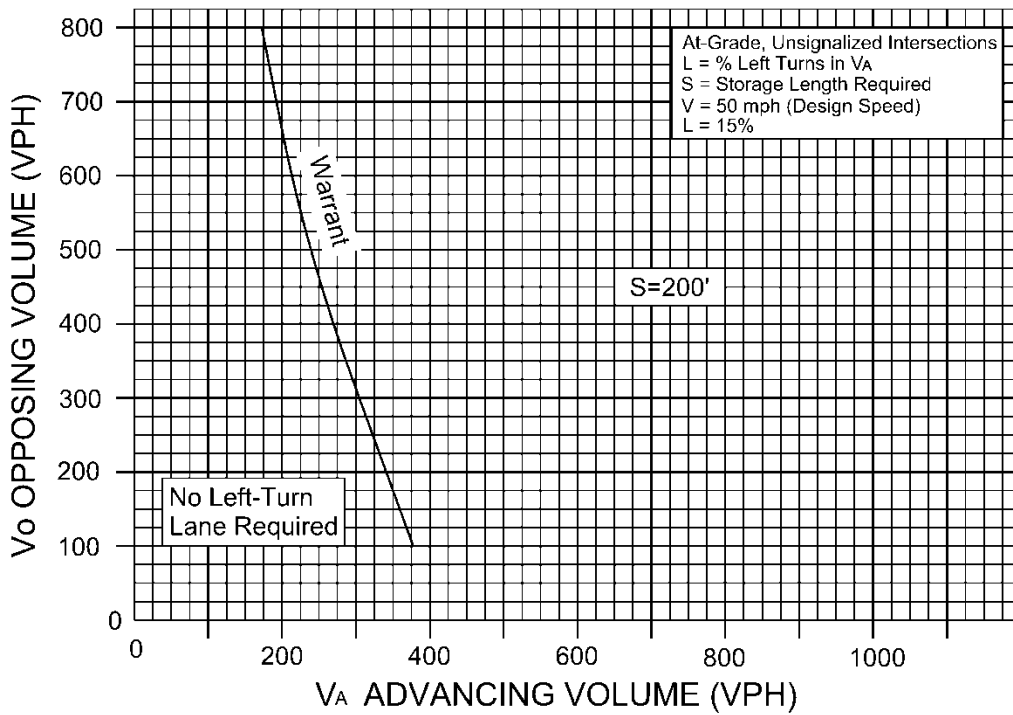

FIGURE 3-13

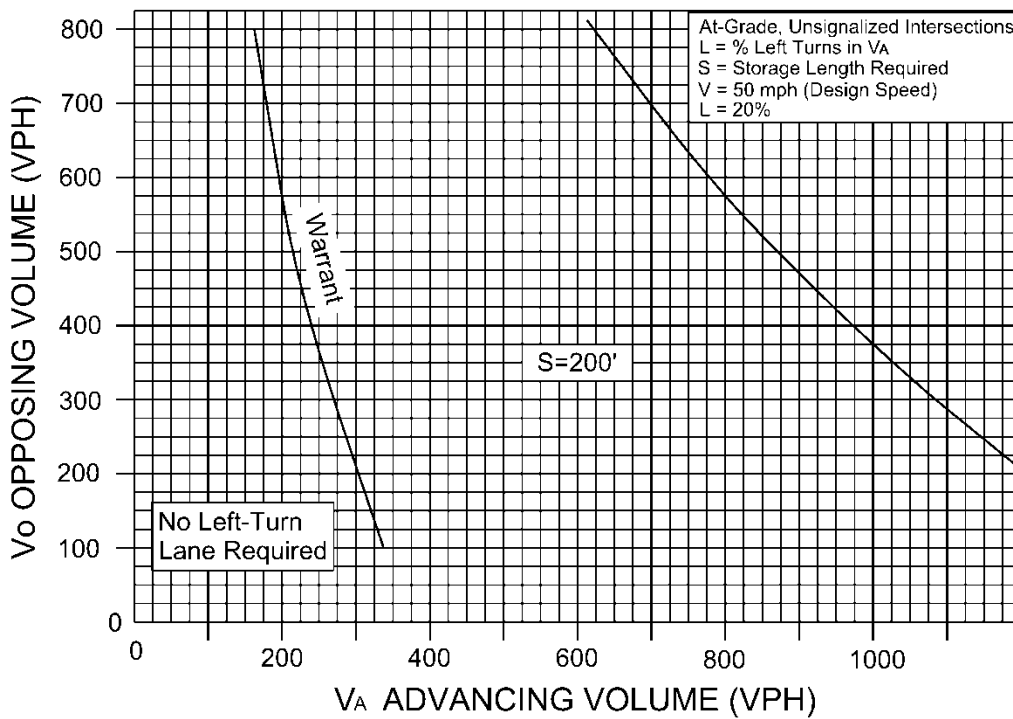

FIGURE 3-14

WARRANT FOR LEFT-TURN STORAGE LANES ON TWO-LANE HIGHWAY

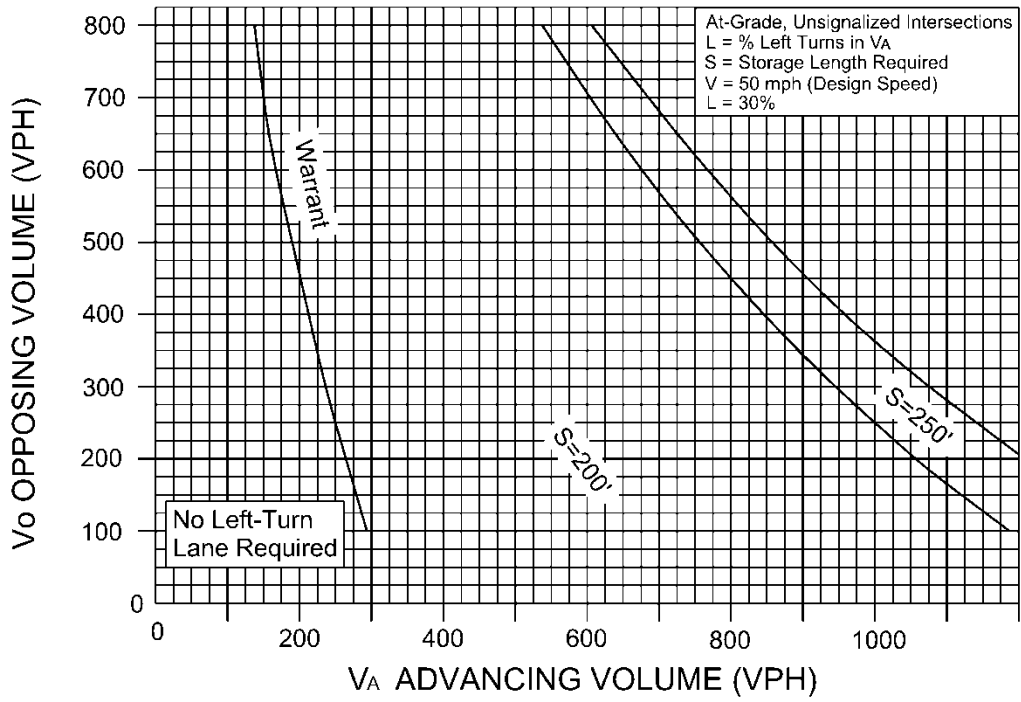

FIGURE 3-15

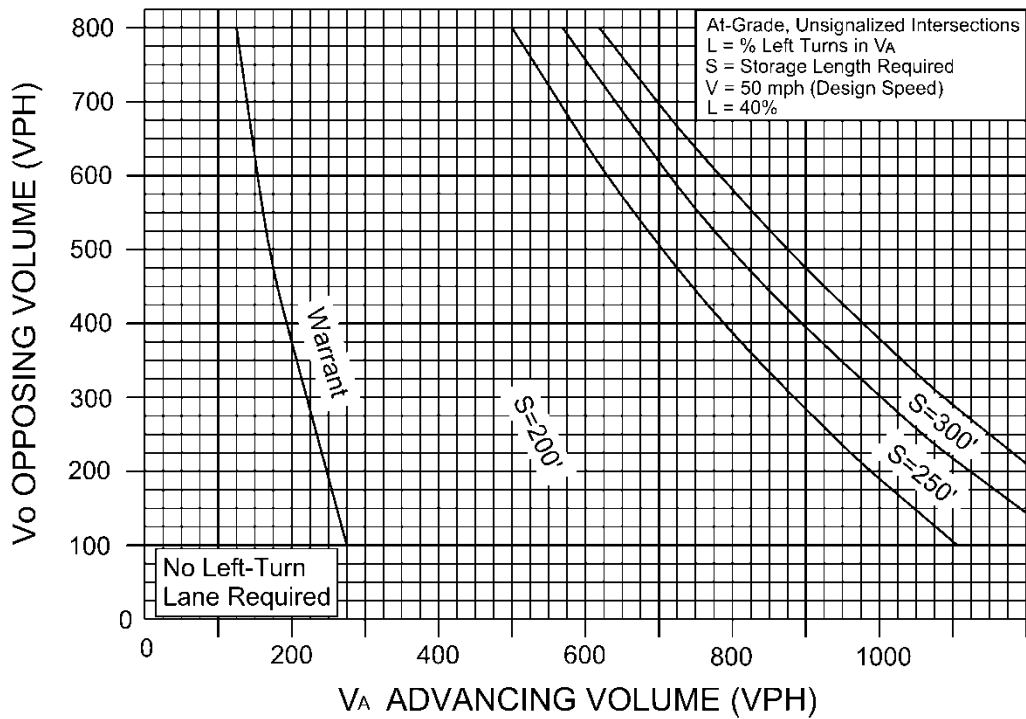

FIGURE 3-16

WARRANT FOR LEFT-TURN STORAGE LANES ON TWO-LANE HIGHWAY

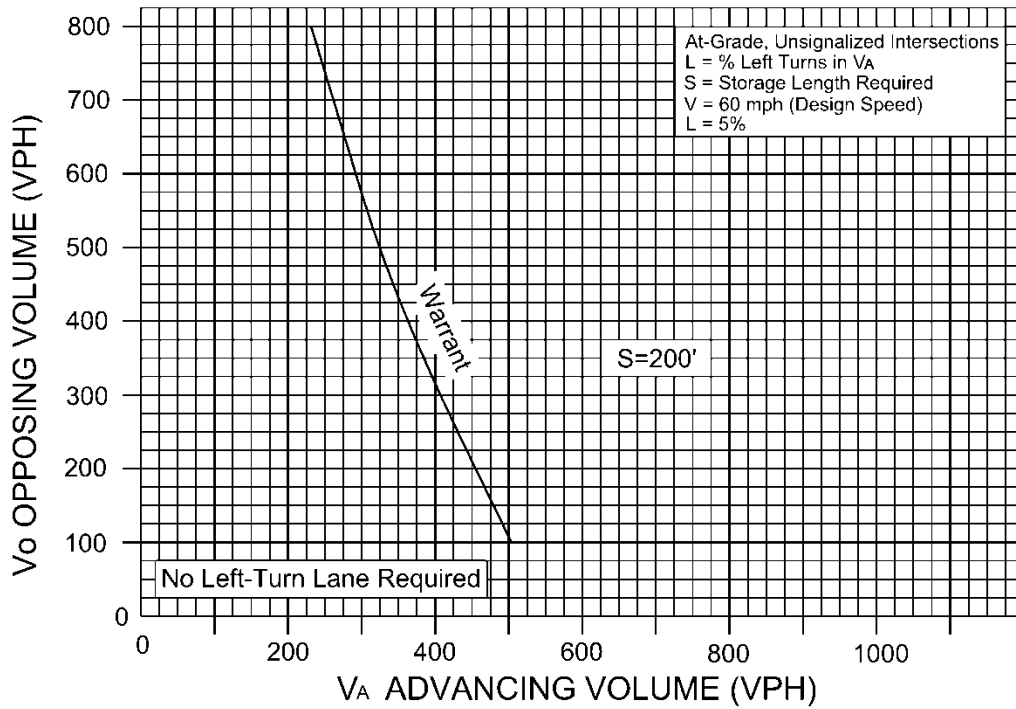

FIGURE 3-17

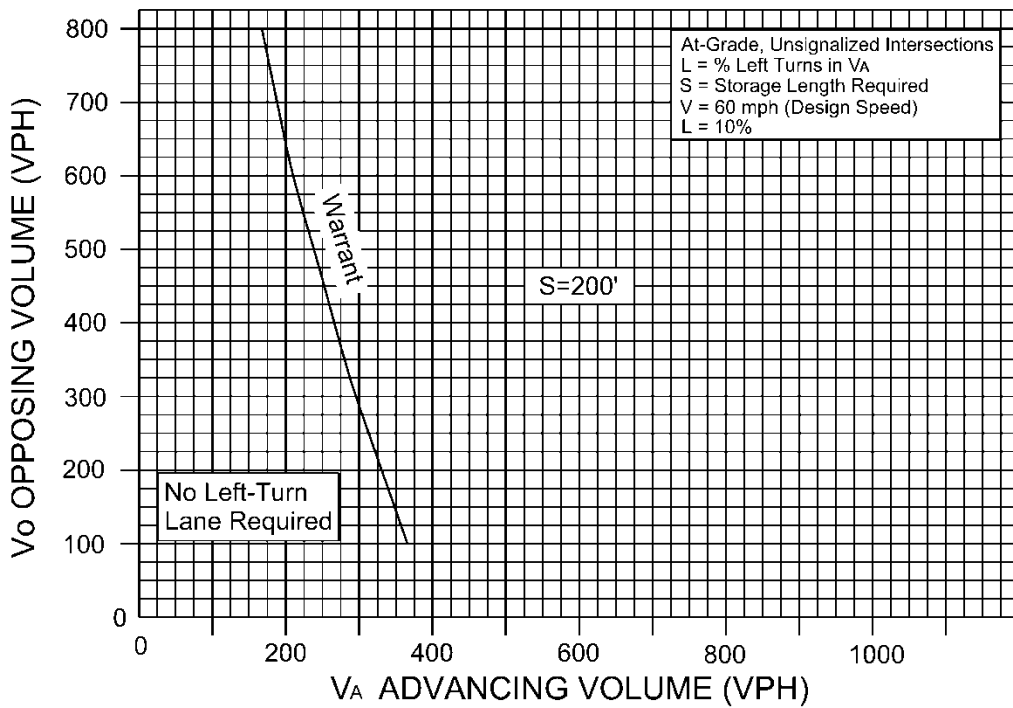

FIGURE 3-18

WARRANT FOR LEFT-TURN STORAGE LANES ON TWO-LANE HIGHWAY

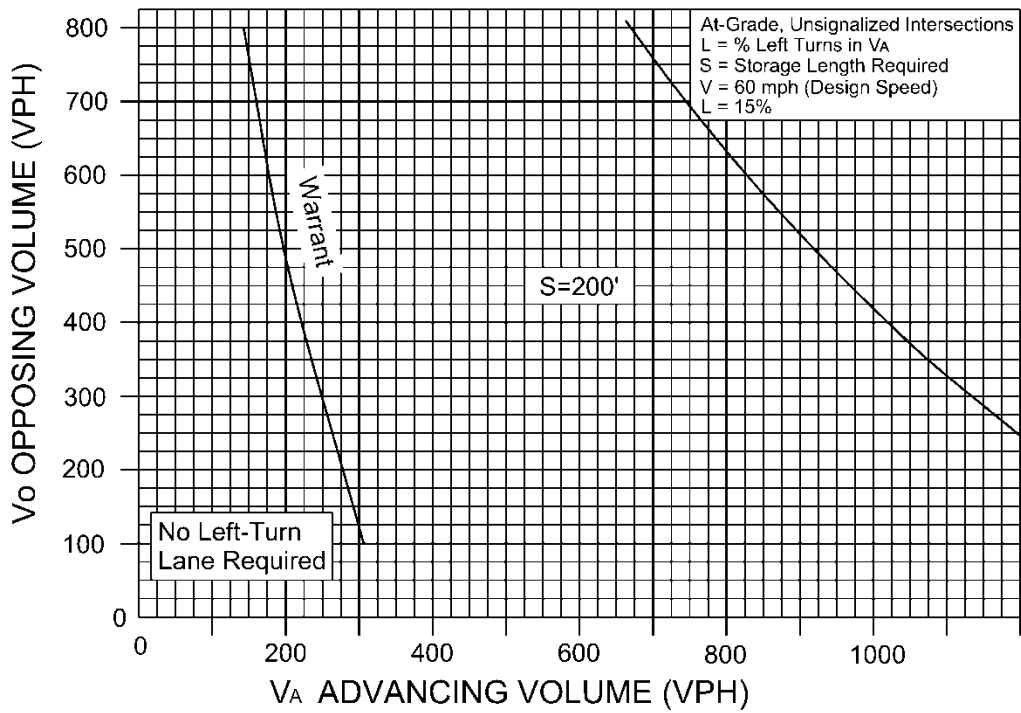

FIGURE 3-19

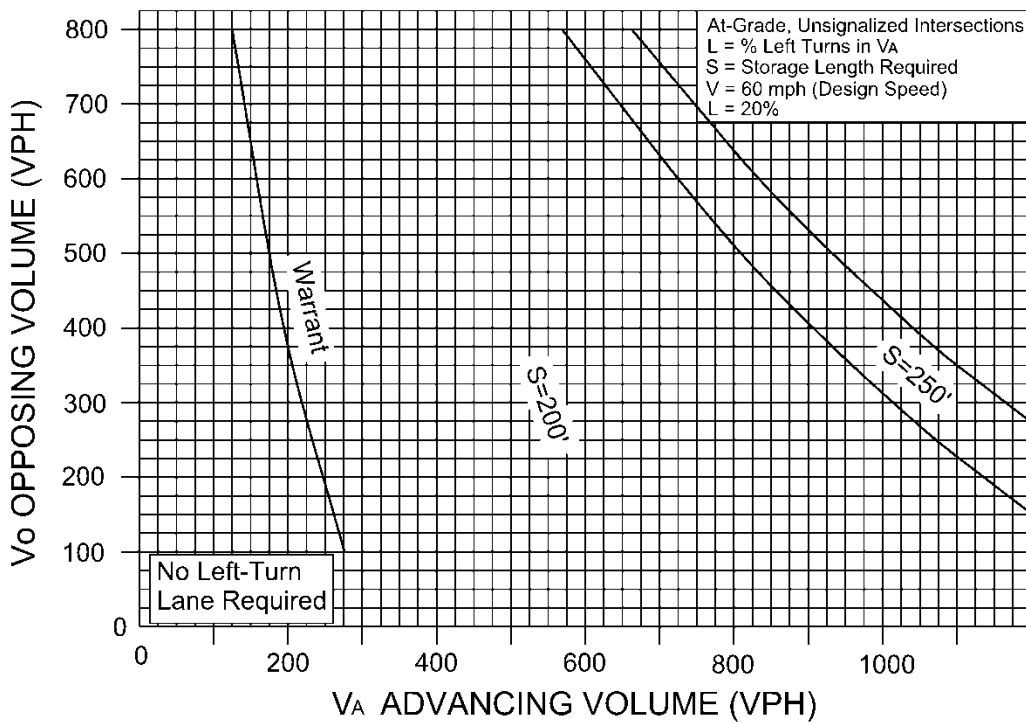

FIGURE 3-20

WARRANT FOR LEFT-TURN STORAGE LANES ON TWO-LANE HIGHWAY

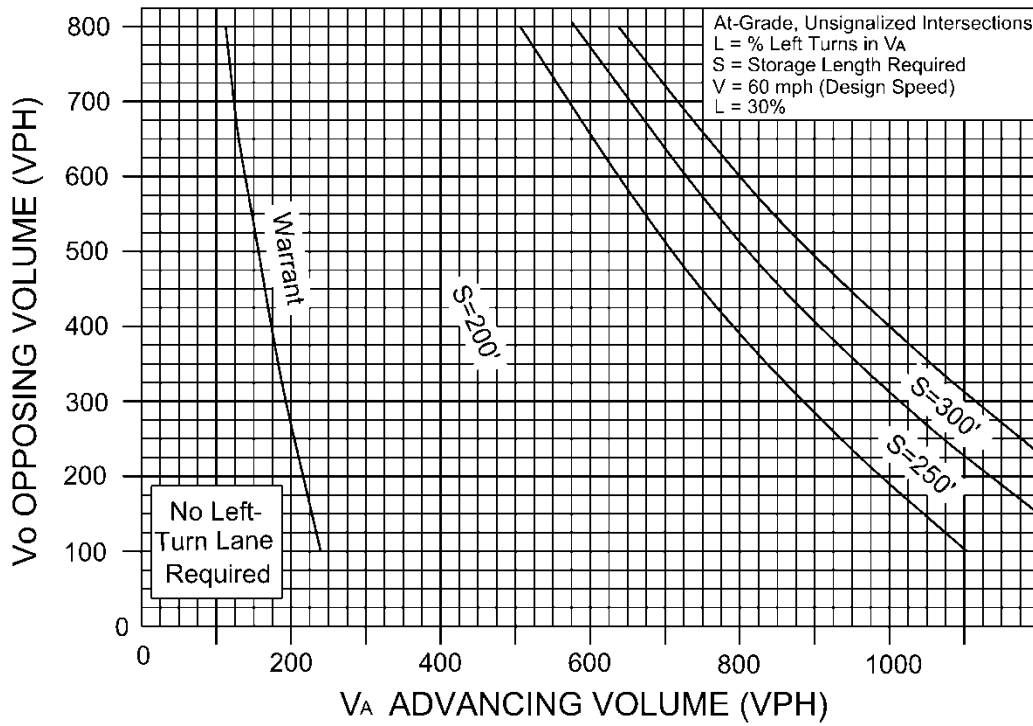

FIGURE 3-21

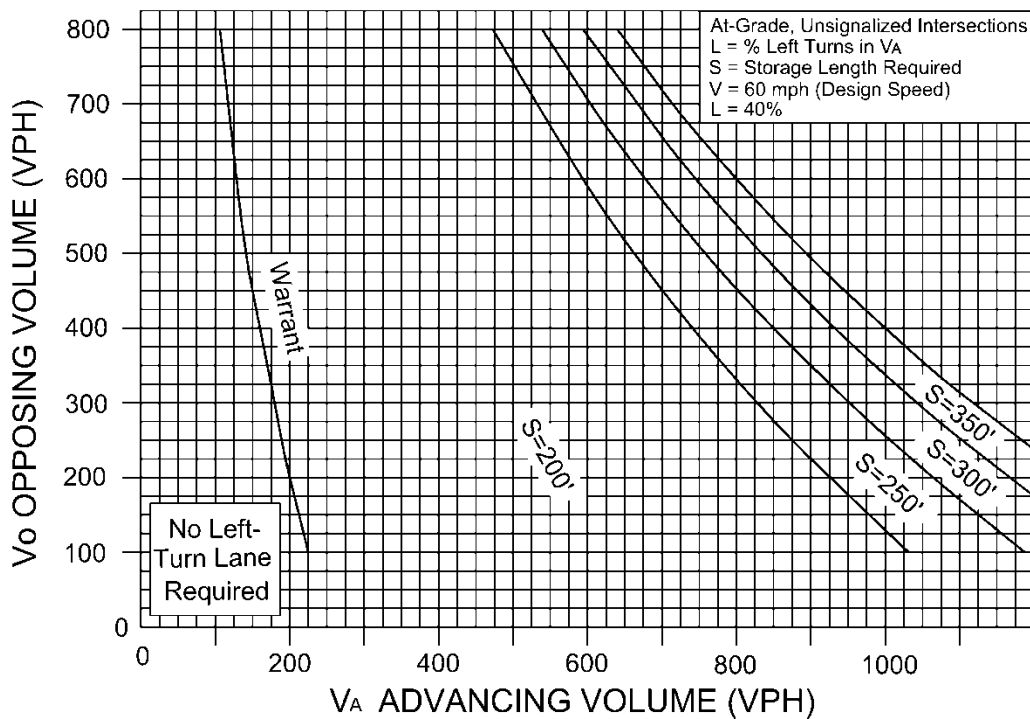

FIGURE 3-22

CHART VALUE OF STORAGE LANE REQUIRED	% TL=% TRUCKS IN VPH turning left					
	0%	10%	20%	30%	40%	50%
100'	0'	25'	25'	50'	50'	50'
125'	0'	25'	25'	50'	50'	75'
150'	0'	25'	50'	50'	75'	75'
175'	0'	25'	50'	75'	75'	100'
200'	0'	25'	50'	75'	100'	100'
250'	0'	25'	50'	75'	100'	125'
300'	0'	50'	75'	100'	125'	150'
350'	0'	50'	75'	125'	150'	175'
400'	0'	50'	100'	125'	175'	200'
450'	0'	50'	100'	150'	200'	225'
500'	0'	50'	100'	150'	200'	250'

TABLE 3-23 TRUCK ADJUSTMENTS

STORAGE LENGTH TO BE ADDED TO CHART VALUES OF LEFT-TURN LANE STORAGE LENGTHS (Length in Feet)

For additional information see Highway Research Report Number 211, Volume Warrants for the Left Turn Storage Lanes at Unsignalized Grade Intersections.

Double (Dual) Left-Turn Lanes

Double (dual) left-turn lanes (DLTL's) shall be considered when left-turn demand exceeds 300 vph, and are desirable where peak left-turn movements exceed 350 vph. DLTL's require a protected (exclusive) signal phase, a minimum 4' raised concrete median separating opposing traffic,* and a width of at least 30' on the acceptance lanes (see Figure 3-23). The length of storage should accommodate at least 1.5 times the expected vehicles making left turns per cycle based on peak 15-min. periods.

When DLTL's are required, a capacity analysis of the intersection should be performed to determine what traffic controls are necessary (i.e. - signalization, separate phasing) in order to have this double left-turn lane function properly.

Continuous Left-Turn Lanes (Two Way in Either Direction)

Continuous two-way median left-turn lanes (C2WMLTL's) should be considered on low-speed arterial highways (25 to 45 MPH) with no heavy concentrations of left-turn traffic. C2WMLTL's also may be used where an arterial or major route must pass through a developed area having numerous street and driveway intersections, and where it is impractical to limit left turns. The minimum width for this application shall be 13' (11' foot lane + 2 feet = 13').

C2WMLTL's shall only be used with roadways having a maximum of 2 through lanes in each direction, and shall be shown in accordance with Figure 3-24.

In commercial and industrial areas where property values are high and rights of way for wide medians are difficult to acquire, a paved flush traversable median 10' to 16' wide is the optimum design. Successful operation of a continuous left-turn lane requires adequate lane marking.

Advantages are:

- Reduced travel time.
- Improved capacity.
- Flexibility of using as temporary detour during closure of through lane.
- Does not control or limit the number of left turns.
- Minimizes interference to through traffic lanes.
- Separates opposing traffic flows by one full lane.
- Public preference (both from drivers and owners of abutting properties.)
- Reduced accident frequency, particularly rear-end collisions.

Disadvantages:

- Poor visibility (corrected by using proper delineation)

* Rev. 7/12

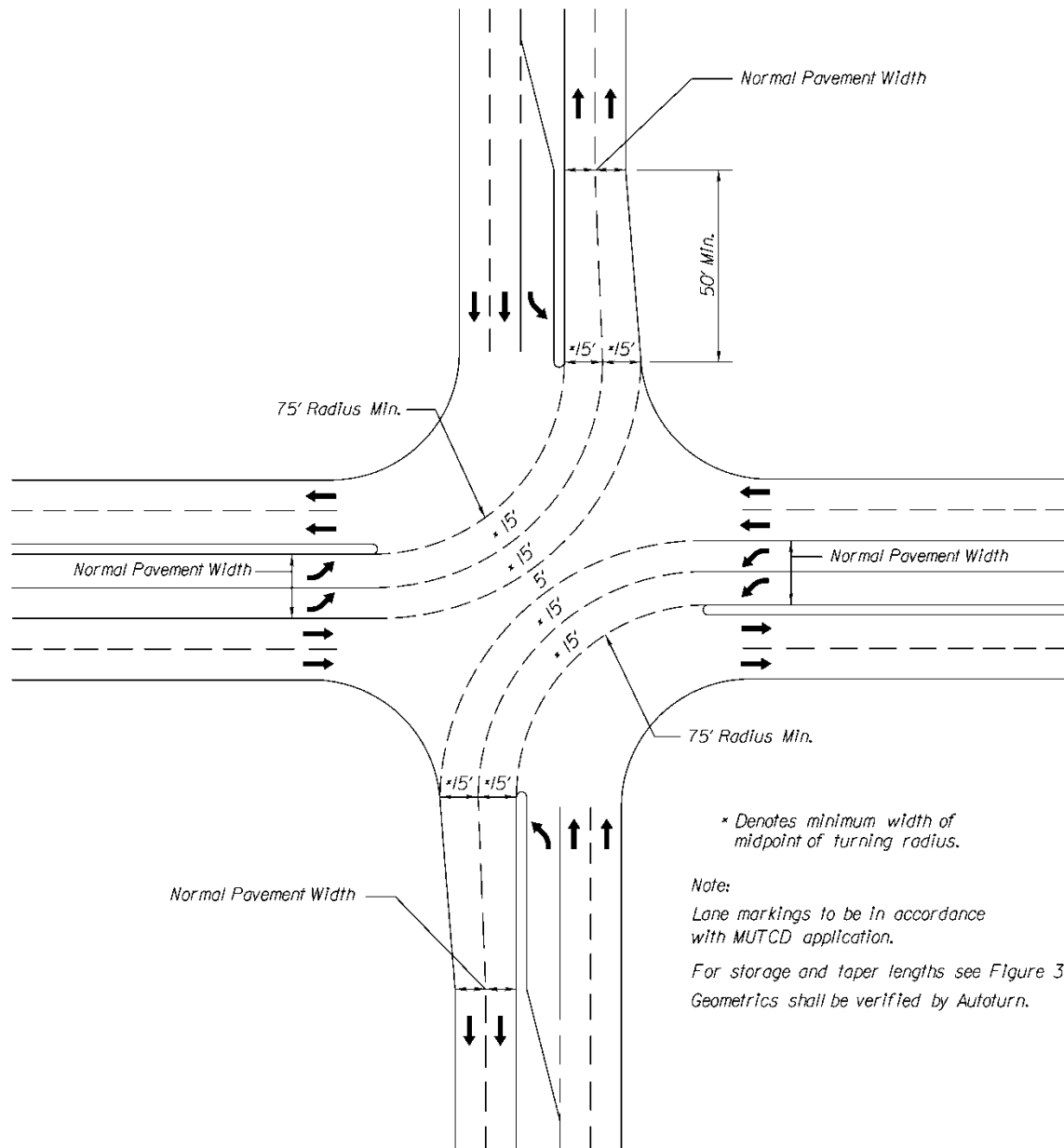
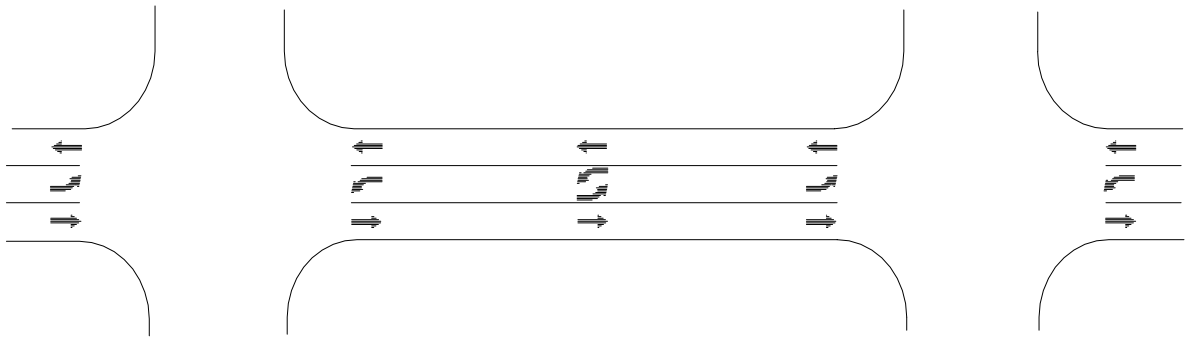
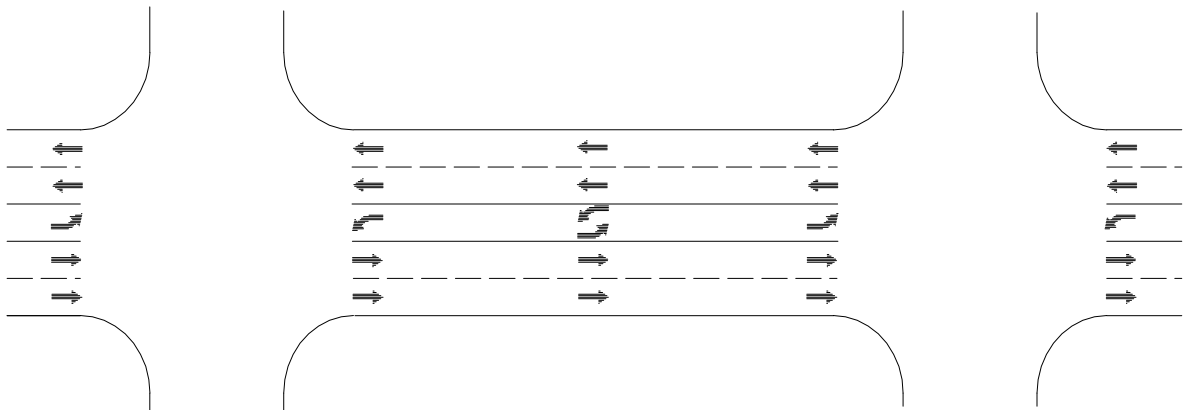

FIGURE 3-23 DOUBLE LEFT-TURN LANES*



Typical 3-Lane Configuration
W/Left Turn Provisions for the Minor Street



Typical 5-Lane Configuration
W/Left Turn Provisions for the Minor Street

FIGURE 3-24 CONTINUOUS TWO-WAY MEDIAN LEFT-TURN LANES
(Lane markings to be in accordance with MUTCD application)

Medians

Channelization: Positive channelization should be provided for all median openings. Standard striping in accordance with the Manual on Uniform Traffic Control Devices (MUTCD) should be used for all openings and speed change lanes in medians without raised channelization. If new curbing is required it should match the existing curb type of the median. Median openings on rural, high-speed highways should be signed with Do Not Enter and One-way signs.

U-turns: The median width may be designed to permit U-turn movements. If a facility is too narrow to safely permit a U-turn, these movements should be addressed in design (such as flare outs in Figure 2-5) or restricted through signage. Sign use and placement require Department approval.

Pavement: Median paving should be full depth and match the pavement section design of the existing roadway.

Drainage Function: Medians frequently provide a conveyance, detention or retention function for roadways. The installation of a median opening should not reduce the conveyance or storage capacity of the median.

Directional Median Opening for Left Turns and U-Turns

A directional median opening for left turns and U-turns limits movements at median openings to specific turns only; the physical design actively discourages or prevents all other movements.

- The technique can be applied to unsignalized median openings on multilane divided urban and suburban streets.

Special Considerations

- The minimum width of a median nose has commonly been 4 feet. AASTHO recommends a minimum median width of not less than 4 feet and 6 to 8 feet wide is preferable where pedestrians may be present.
- Narrow median noses are difficult to see especially at night and in inclement weather. Reflectorized paint is of little help as it rapidly becomes dirty and loses its limited reflectivity. Reflectorized traffic buttons or reflectorized pylons help but lack the mass necessary to provide good target value.

- Carefully selected landscaping is the most effective way to ensure high visibility of the median and median openings.
- Landscaping of the median nose for visibility is especially important where long left-turn lanes are used. The choice of vegetation and the landscaping design must ensure that sight distance is not obstructed.
- Overlapping of the separators of a directional median opening restricts movements to the intended left turn or U-turn.
- Directional median openings will accommodate U-turns by automobiles where the separation is at least 4 feet wide and there are three opposing lanes. Where there are two opposing lanes a triangular flare of 10 feet along the intersecting roadways and at least 20 feet along the major roadways will allow an automobile to execute a U-turn.

Advantages

- The directional median opening for left turns and U-turns improves safety by limiting the number and location of conflict points and by prohibiting direct crossing.
- Right-angle crashes are avoided because vehicles are prevented from crossing where the median width is not sufficient for drivers to cross one-traffic stream at a time.

Disadvantages

- Cross-median movements are limited to specific locations and to specific turns.
- It is not practical to design for U-turns executed by large vehicles in all directions.

Illustration of Directional Median Opening for Left Turns and U-Turns

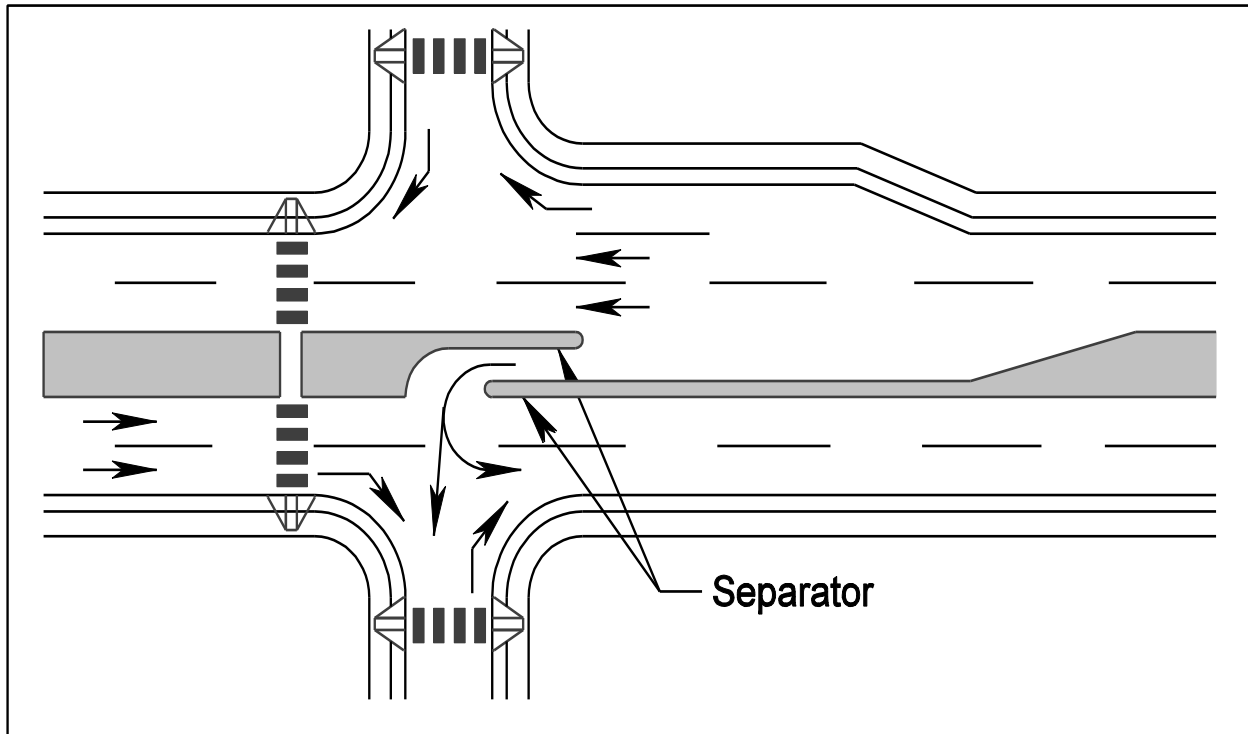

FIGURE 3-25 ILLUSTRATION OF DIRECTIONAL MEDIAN OPENING FOR LEFT TURNS AND U-TURNS

Source: TRB, Access Management Manual, Dated 2003

Examples

- Some states make extensive use of directional median openings. Preference is given to left turns and U-turns from the major roadway. Existing full median openings are reconstructed as directional openings as part of resurfacing projects or reconstruction projects. The minimum width of 2 feet can be accommodated in the standard 16 foot raised median. Separators are overlapped by at least 2 feet.
- The Michigan DOT has pioneered a variation of the directional median opening called the Michigan U-Turn. This design involves the installation of directional openings near signalized intersections.

Right Turn Lanes

An exclusive right-turn lane should be considered when the warrants in Figures 3-26 and 3-27 are met. Double exclusive right-turn lanes may be provided when capacity analysis warrants. Safety implications associated with pedestrians and bicyclists should always be considered.

These guidelines are to be used as an aid in selecting appropriate treatments for right turn movements. (Reference material attained from Virginia Highway and Transportation Research Council report "The Development of Criteria For the Treatment of Right Turn Movements on Rural Roads" dated March 1981).

1. Number of Lanes – Guidelines are differentiated on the basis of the number of lanes on the major roadway. Refer to Figure 3-26 for 2-lane roadways and Figures 3-27 for 4-lane roadways. The minor roadway is a 2-lane road. Discussion on both figures is provided. All volumes refer to the volumes on the approach under consideration for right turn treatments.
2. Radius Treatment – Refer to guidelines for right turn treatment on 2-lane roadways. The predominant treatment for 2-lane roadways is the radius. Arterial roadways tend to carry higher volumes of traffic traveling at higher speeds as compared to local roadways.

The traffic on local roadways tends to include a higher number and percentage of right turning vehicles than that on arterials. An adjustment is needed to permit local roadways to handle more right turns (at lower speeds) compared to arterial roads. The following adjustment is made for posted speeds at or under 45 mph.

Adjusted Number of Right Turns = Number of Right Turns - 20 for number right turns > 40 and total volume < 300

For example, Total volume = 200 vph, Right turn volume = 70 vph and Posted speed = 40 mph. Then adjusted number of right turns - $r = 70 - 20 = 50$. Therefore, projecting a total volume 200 vph and $r = 50$ vph in the table, a radius is recommended for the right turn treatment.

3. Four lane Roadways – Four lane roadways tend to have a taper or full width lane to facilitate right turn movements. Many of these roads are divided highways with a speed limit of 55 mph.
4. Curb Channelized Island – Curb channelized island should be considered to separate right turn lanes from thru traffic based on capacity analysis.

5. Other factors – The selection of a treatment for right turn movements may be influenced by sight distance, availability of right-of-way, grade, and angle of turn. Although these factors are not incorporated in the guidelines, they should be given consideration. The guidelines should be used unless the Engineer at the District or Residency determines that special treatment is necessary due to other factors.
6. Data collection procedures – In order to employ these guidelines, peak hour volume data must be provided.

Right / Left Turn Lanes may be required beyond these guidelines at the discretion of the District Administrator's designee.*

Conditions for providing an exclusive right turn lane when the right turn traffic volume projections don't exceed the guidelines:

- Facilities having a high volume of buses, trucks or trailers.
- Poor internal site design of a entrance facility causing potential backups in the through lanes.
- Heavier than normal peak flows on the main roadway.
- High operating speeds (such as 55 mph or above) and in rural locations where turns are not expected by through drivers.
- Highways with curves or hills where sight distance is impacted.
- Higher functionally classified highways shall be considered so that the impact of turning movements on highways intended to serve through traffic is minimized.

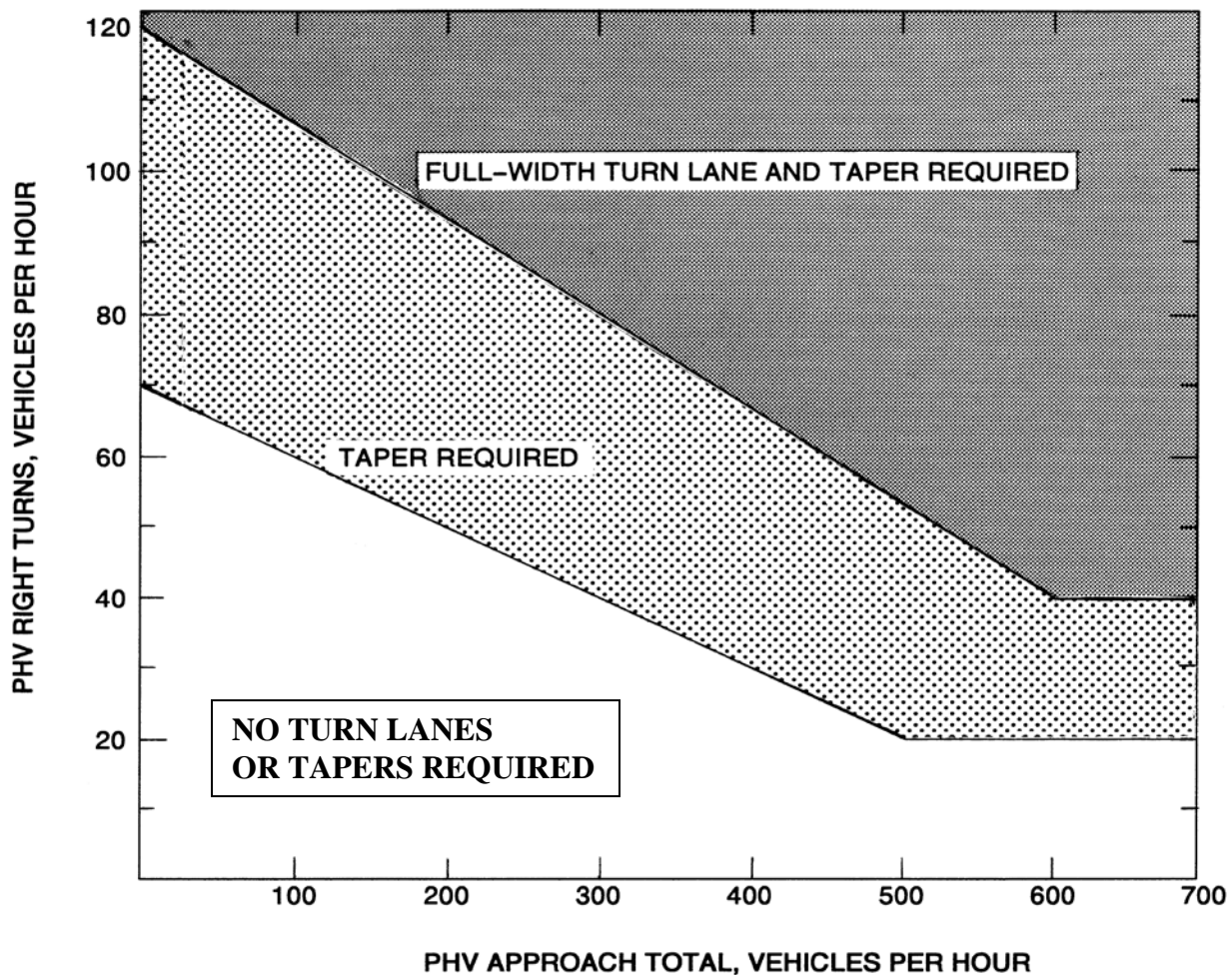

Appropriate Radius required at all Intersections and Entrances (Commercial or Private).

LEGEND

PHV - Peak Hour Volume (also Design Hourly Volume equivalent)

Adjustment for Right Turns

For posted speeds at or under 45 mph, PHV right turns > 40, and PHV total < 300.

Adjusted right turns = PHV Right Turns - 20

If PHV is not known use formula: $PHV = ADT \times K \times D$

K = the percent of AADT occurring in the peak hour

D = the percent of traffic in the peak direction of flow

Note: An average of 11% for K x D will suffice.

FIGURE 3-26 GUIDELINES FOR RIGHT TURN TREATMENT (2-LANE HIGHWAY)

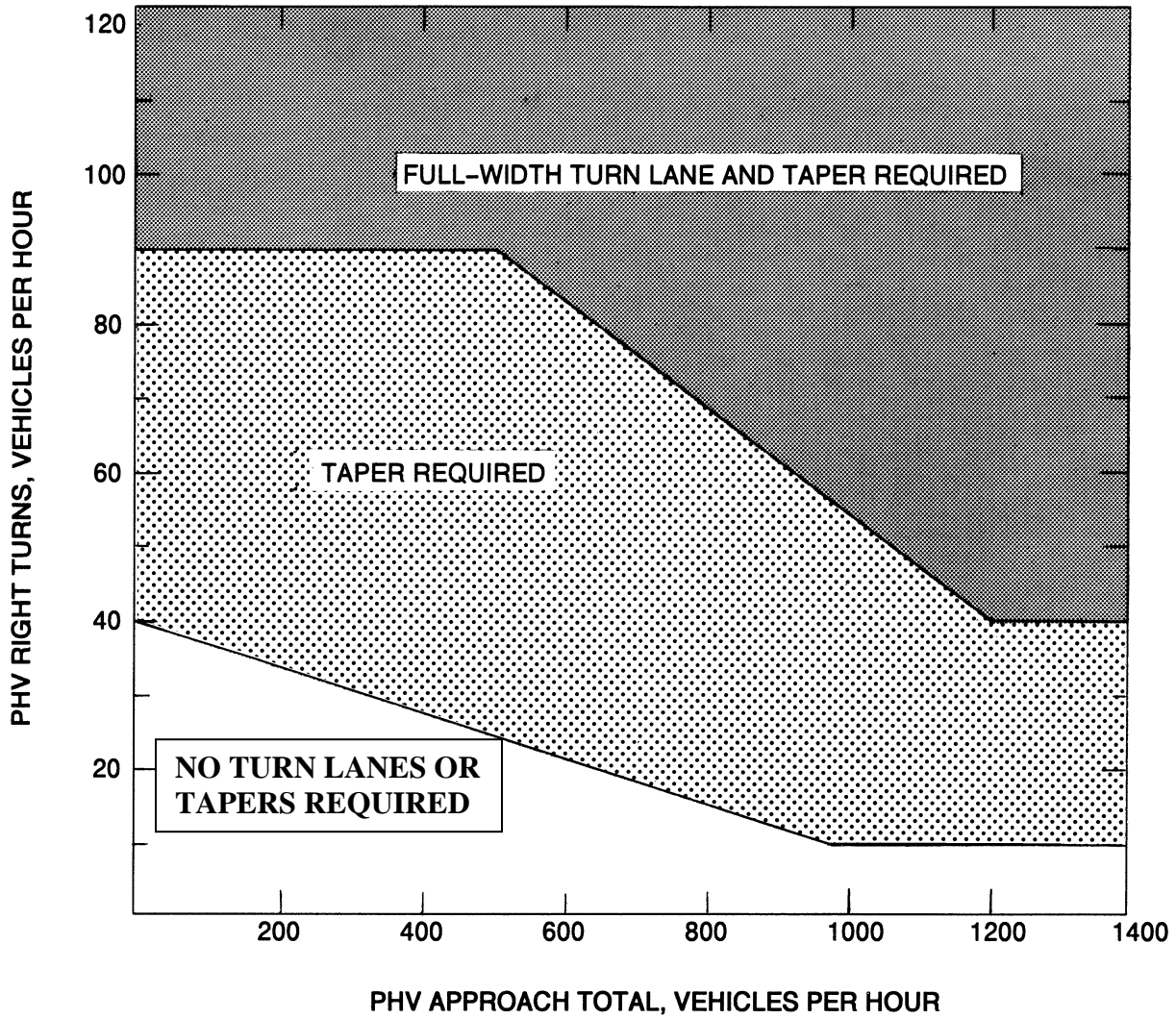

Appropriate Radius required at all Intersections and Entrances (Commercial or Private).

LEGEND

PHV- - Peak Hour Volume (also Design Hourly Volume equivalent)

Adjustment for Right Turns

If PHV is not known use formula: $PHV = ADT \times K \times D$

K = the percent of AADT occurring in the peak hour

D = the percent of traffic in the peak direction of flow

Note: An average of 11% for K x D will suffice.

FIGURE 3-27 GUIDELINES FOR RIGHT TURN TREATMENT (4-LANE HIGHWAY)

Acceleration Lanes

Acceleration lanes should consist of a full-width lane and a transition taper. Acceleration lanes should be designed so that a turning vehicle will obtain* the highway posted speed at the point where the full -width lane ends and transition taper begins.

- Acceleration Lane: See AASHTO Green Book Exhibit 10-70 Minimum Acceleration Lengths for Entrance Terminals with Flat Grades of 2% or Less.
- Transition Taper: See Section 3 – Turning Lanes, Figure 3-1 Left and Right Turn Lanes Criteria in this chapter.

* Rev. 7/10

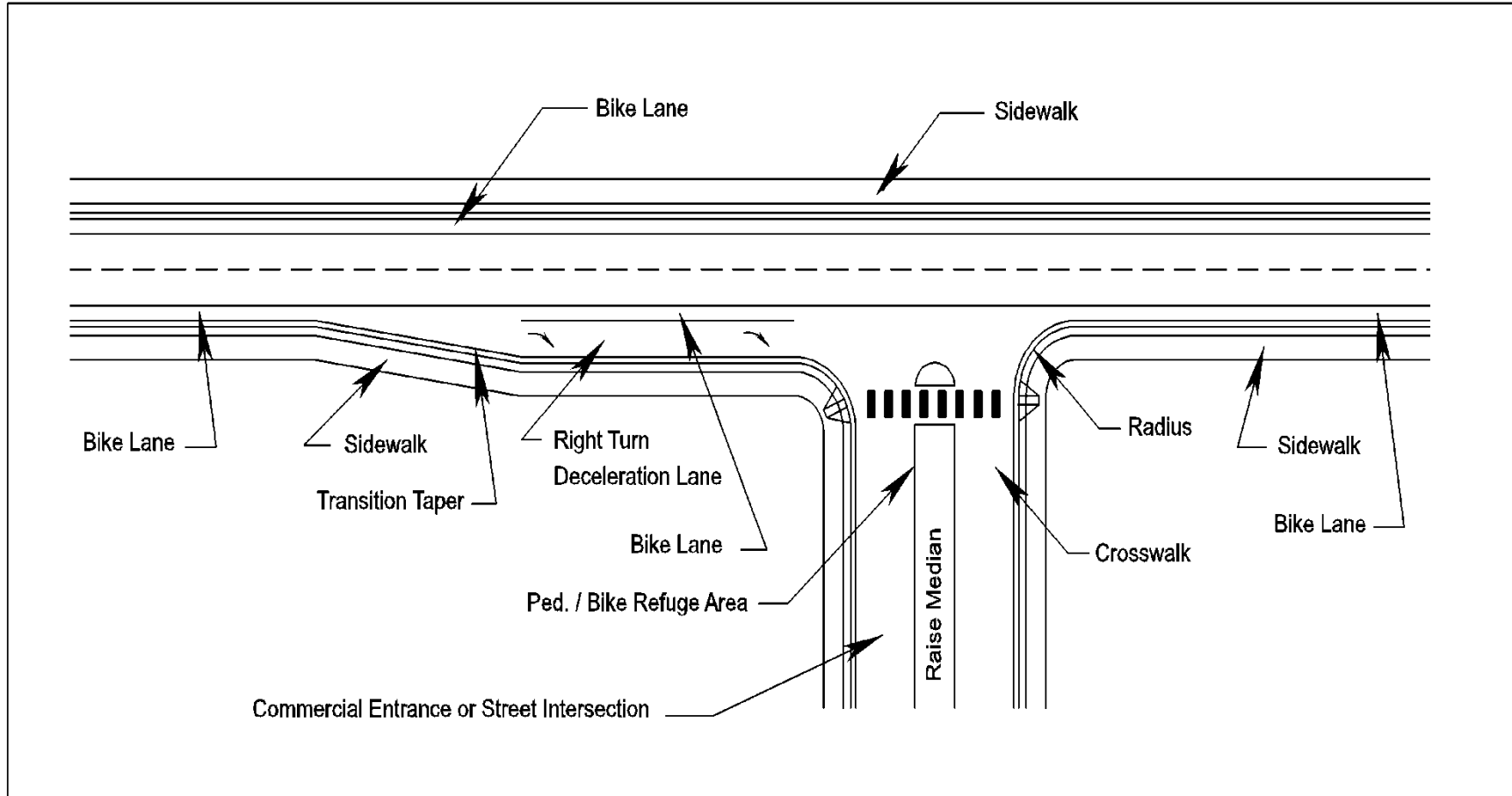

FIGURE 3-28 TYPICAL APPLICATION WITH SIDEWALKS AND BIKE LANES WITH RIGHT-TURN DECELERATION LANES (CURB AND GUTTER SECTION)

Note: All entrance design and construction shall accommodate pedestrian and bicycle users of the highway in accordance with the Commonwealth Transportation Board’s “Policy for Integrating Bicycle and Pedestrian Accommodations”.

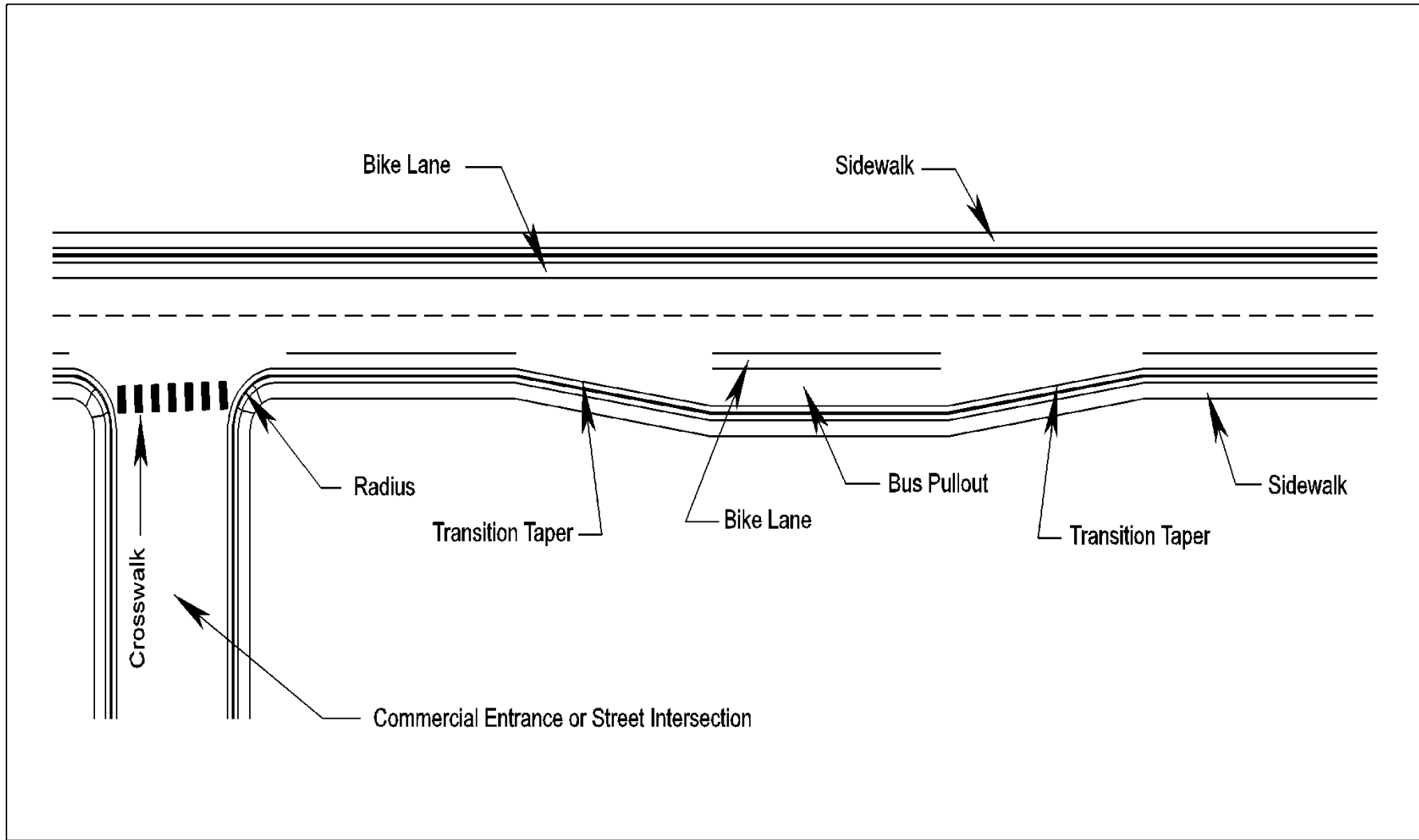

FIGURE 3- 29 TYPICAL APPLICATION OF A BUS PULLOUT

Note: All entrance design and construction shall accommodate pedestrian and bicycle users of the highway in accordance with the Commonwealth Transportation Board’s “Policy for Integrating Bicycle and Pedestrian Accommodations”.

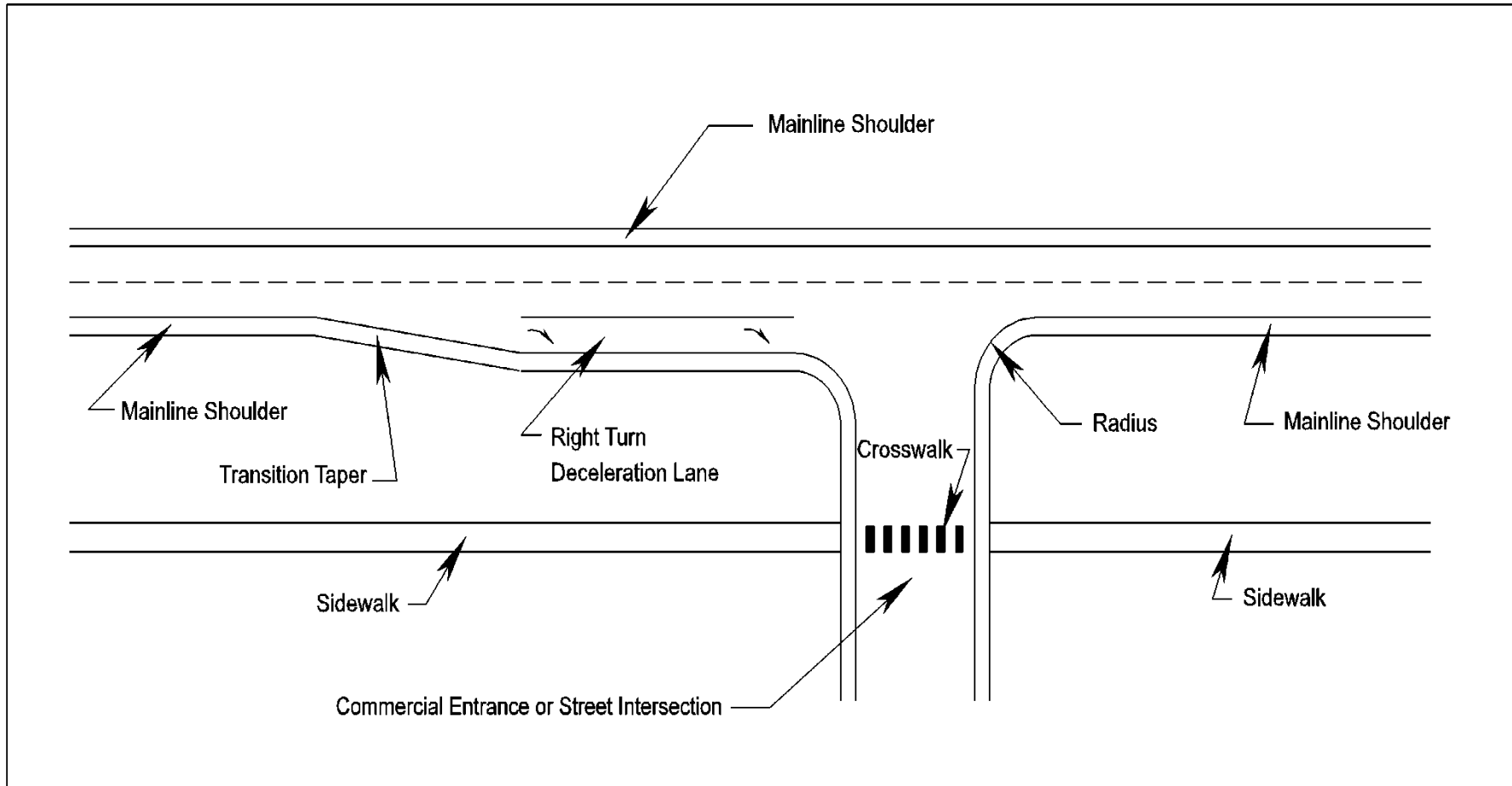

FIGURE 3-30 TYPICAL APPLICATION OF A RIGHT TURN DECELERATI ON LANE (SHOULDER SECTION)

Note: All entrance design and construction shall accommodate pedestrian and bicycle users of the highway in accordance with the Commonwealth Transportation Board’s “Policy for Integrating Bicycle and Pedestrian Accommodations”.

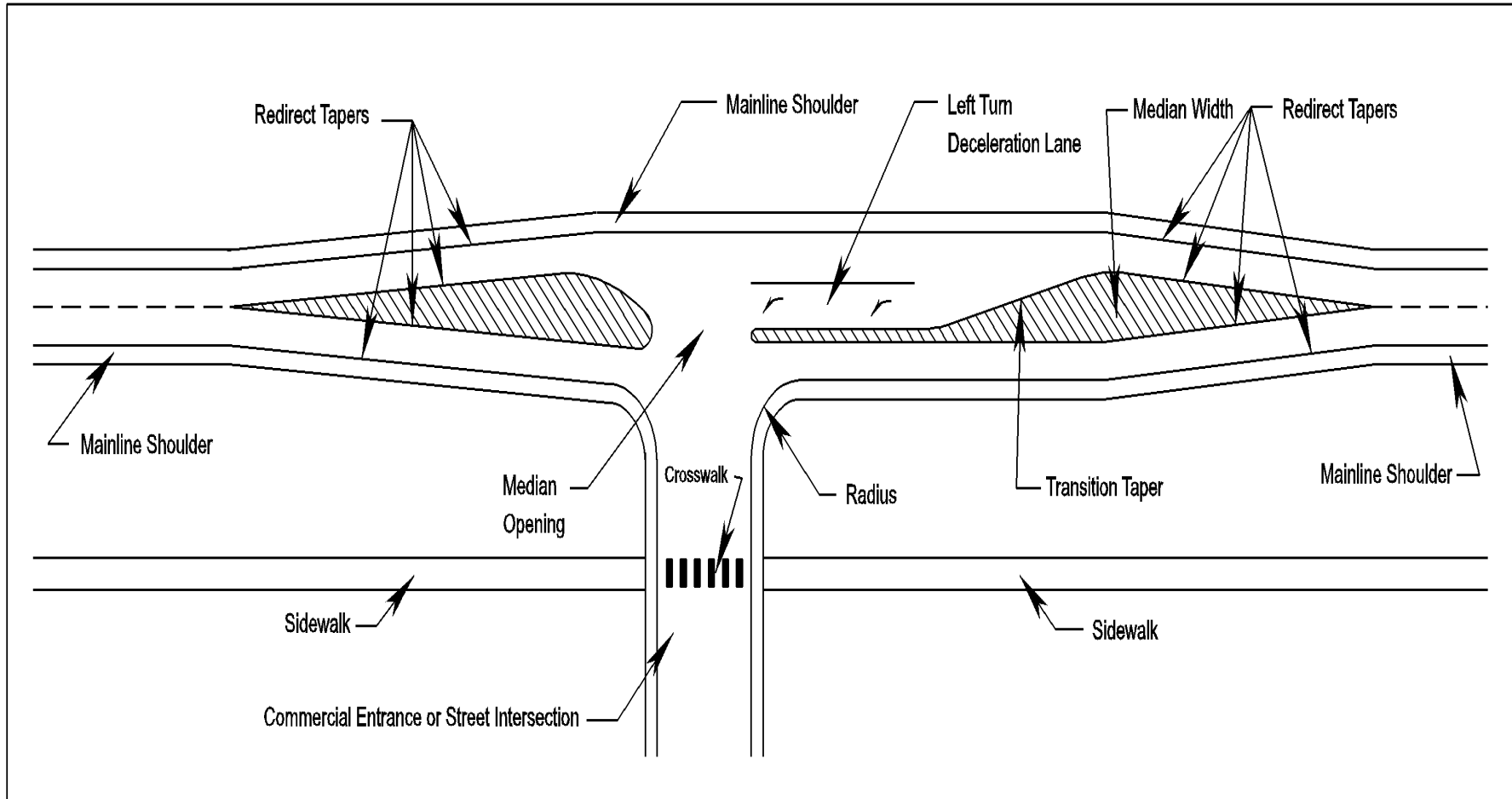
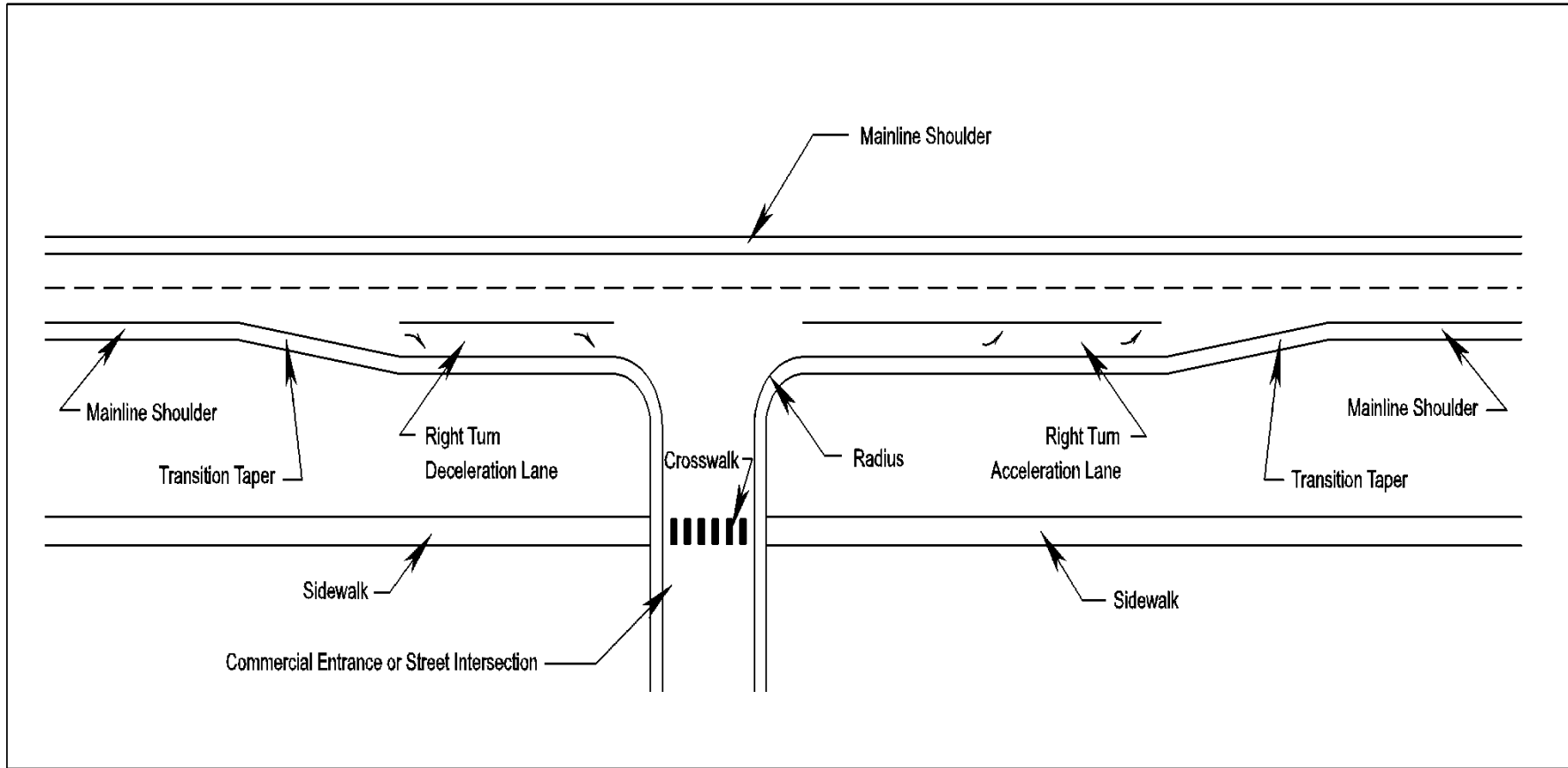

FIGURE 3-31 TYPICAL APPLICATION OF A LEFT TURN DECELERATION LANE (SHOULDER SECTION)

Note: All entrance design and construction shall accommodate pedestrian and bicycle users of the highway in accordance with the Commonwealth Transportation Board’s “Policy for Integrating Bicycle and Pedestrian Accommodations”.



**FIGURE 3- 32 TYPICAL APPLICATION OF A RIGHT TURN ACCELERATION AND DECELERATION LANE
(SHOULDER SECTION)**

Note: All entrance design and construction shall accommodate pedestrian and bicycle users of the highway in accordance with the Commonwealth Transportation Board’s “Policy for Integrating Bicycle and Pedestrian Accommodations”.

SECTION 4 – ENTRANCE DESIGN

Entrance Design Principles

Entrances are, in effect, at-grade intersections and should be designed consistent with the intended use. Entrance design and location merit special considerations in order to reduce the number of crashes that occur at entrances. Entrances **shall** not be situated within the functional area of an intersection or in the influence area of an adjacent entrance. The functional area extends both upstream and downstream from the physical intersection area and includes the longitudinal limits of auxiliary lanes, see Figure 4-2A. If however, existing entrances are located within the functional area of the intersection Part A of the Waiver Form AM-3 shall be completed and submitted to the District Location and Design Engineer for approval.*

Entrance Angle: The entrance centerline should be perpendicular to the state highway centerline and extend tangentially for a minimum distance of 40 feet beyond the near-side edge line. An acute angle between 60 degrees and 90 degrees may be permitted if significant physical constraints exist. Acute angles less than 60 degrees shall require special approval of the Department.

Entrance Radius: The entrance radius should be designed to accommodate the design vehicle expected to use the entrance on a daily basis.

Design Vehicle and Turning Radius by Land Use		
Land Use(s) Served by Access	Design Vehicle	Radius
Office with Separate Truck Access	Passenger Car/Pickup	24
Office without Truck Access	Single Unit Truck	42
Commercial / Retail with Separate Truck Access	Passenger Car/Pickup	24
Commercial / Retail without Separate Truck Access	WB-50 Truck	45
Industrial with Separate Truck Access	Passenger Car/Pickup	24
Industrial without Separate Truck Access	WB-50 Truck	45
Recreational without Watercraft Access or Camping	Passenger Car/Pickup	24
Recreational with Watercraft Access or Camping	Motor Home/Boat	50
Agricultural Field Access	Single Unit Truck	42
Municipal and County Roads	WB-50 Truck	45

TABLE 4-1 DESIGN VEHICLE AND TURNING RADIUS BY LAND USE

Note: “with Separate Truck Access” indicates truck prohibition from primary access.

Entrances into mixed use developments will be designed to accommodate the largest design vehicle expected to use that entrance.

* Rev. 7/12

Private and Low Volume Commercial Entrances

1. Low Volume Commercial Entrance

Except for the sight distance provision in item 4, the private entrance design standards below and in Figure 4-1 apply to low volume commercial entrances. Low volume commercial entrances shall be placed at locations that provide adequate stopping sight distance as shown in Table 2-6.*

2. Curb and Gutter Private Entrances

Standard entrance gutter (Std. CG-9D; other options are CG-9A or CG-9B) shall be used with Std. CG-6 or CG-7 curb and gutter. A special design entrance gutter shall be submitted for approval when roll top curb is used.

3. Ditch Section Private Entrances

All private entrances shall be designed to serve no more than two individual lots. All private entrances shall be designed and constructed as shown in Figure 4-1. Entrance radius shall be 20' minimum. All entrance pipe culverts will be sized to accommodate the run-off expected from a 10-year frequency storm.

All private entrance grades shall start back of the shoulder line. If drainage is necessary, the ditch line may be moved back to provide 9 inches minimum cover over pipe. Entrances shall be at least 12' wide and shall be tied smoothly into the roadway surface. The entrance surface can be crusher run aggregate (gravel), asphalt, concrete, etc. and shall extend from the edge of the roadway to the right-of-way line.

Alternate methods for placing pipe culverts under the entrance (cut/fill details) are presented in the PE-1 design standard illustration in the VDOT Road and Bridge Standards, Section 600. The PE-1 standard is available on the VDOT web site at <http://www.extranet.vdot.state.va.us/LocDes/Electronic%20Pubs/2008Standards/CSection600.pdf>

4. Private Entrance Sight Distance

The installation of a private entrance cannot be denied on the basis of sight distance. The Department will review the property owner's highway frontage and determine a useable location for the private entrance with the best possible sight distance. The property owner's preferred location can be denied by the Department if the location does not have the best possible sight distance and therefore is less safe for users of the entrance as well as for motorists on the intersecting highway. The Department may require the property owner to grade slopes, clear brush, remove trees, or conduct other similar efforts, or any combination of these, necessary to provide the safest possible means of ingress and egress that can be reasonably achieved.

5. Private Entrance Grades

In the interest of assuring an adequate, convenient, and safe access to public roads, VDOT recommends the grades along private entrances not exceed 10%.

* Rev.1/12

6. Modification of an Existing Entrance

When an existing street is re-developed and modification of an existing entrance is required, the entrance surface shall be extended to the right-of-way line or the extent of disturbance to the existing entrance.

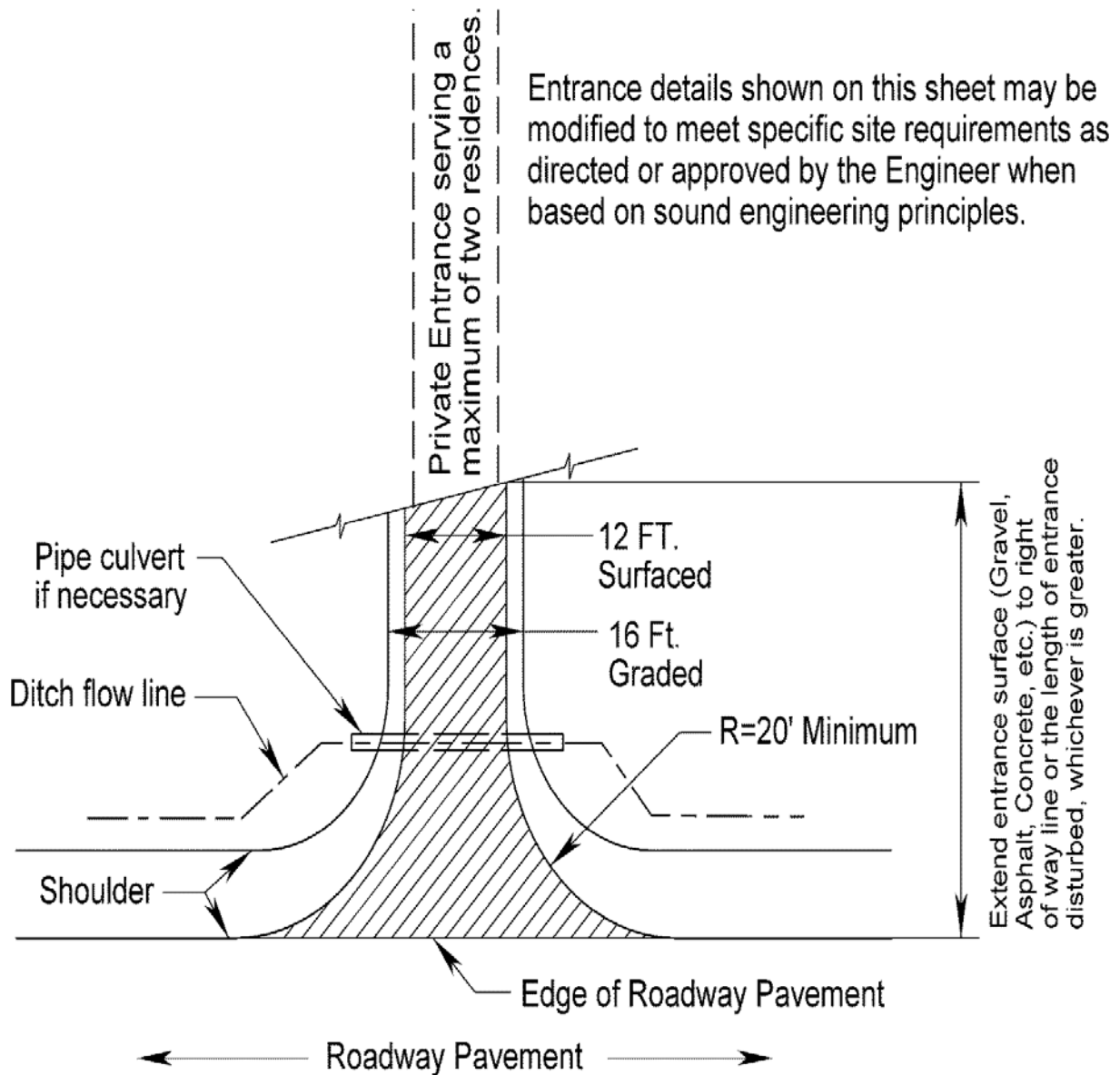

**FIGURE 4-1 PRIVATE ENTRANCE AND LOW VOLUME COMMERCIAL ENTRANCE
DETAIL***

* Rev. 7/12

Commercial Entrances

All commercial entrances shall be designed in accordance with the entrance design diagrams Figures 4-8 to 4-15 to promote safe and efficient movement of vehicles in the entrance and on state highways.

An access shall not be approved for parking areas that require backing maneuvers within state highway right-of-way. All off-street parking areas must include on-site maneuvering areas and aisles to permit vehicles to enter and exit the site in forward drive without hesitation. For Parking Space Guidelines See [Appendix "C"](#).*

Entrance Medians: Entrance medians should be used when two or more lanes are required for both the entering and the exiting movements at the entrance.

- Entrance medians shall have a minimum width of 4 feet.
- All curbing within the highway clear zone shall be in accordance with VDOT's Road and Bridge Standards, or as approved by the District Administrator or designee, and appropriate for the operational speeds of the facility.
- Non-regulatory signs shall not be placed in the portion of an entrance median located within the right-of-way, or within the highway clear zone, and shall not restrict intersection sight distances.
- An entrance median should not contain structures, signs, or landscaping which restrict sight distance. The minimum size of a entrance median island is 100 square feet.

Entrance Throat: The entrance throat should be designed to facilitate the movement of vehicles off the highway to prevent the queuing of vehicles on the traveled way.

The throat length is based on the traffic a development will generate, not the characteristics of the abutting highway. The more traffic using the entrance, the greater the number of ingress/egress lanes will be needed within the entrance, which determines the length of the entrance throat.

Both sides of the entrance throat need to be protected.

* Rev. 7/10

The length of the entrance-side throat needs to equal the exiting throat. When entering vehicles stop to turn left there must be sufficient queuing length to prevent other entering vehicles from backing up on to the highway. Minimum connection throats are provided in the table below.

Entrance throats apply to entrances to commercial uses, corner clearance establishes the "Throat" of a minor street intersecting a major street.

Summary of Entrance Throats	
Number of Egress Lanes (left, thru and right)	Minimum Throat Length
	Feet
1	35 *
2	75
3	200
4	300

TABLE 4-2

Source: Transportation & Land Development 2nd Edition 2003, Koepke and Stover

* Inadequate entrance length can also produce hazards to entering traffic on site. Particularly where the on-site parking can back out of and block the entrance and prevent a vehicle from entering. To avoid this problem, a distance of at least 50 feet should be used on entrance length where back out parking may interfere with entry movement.*

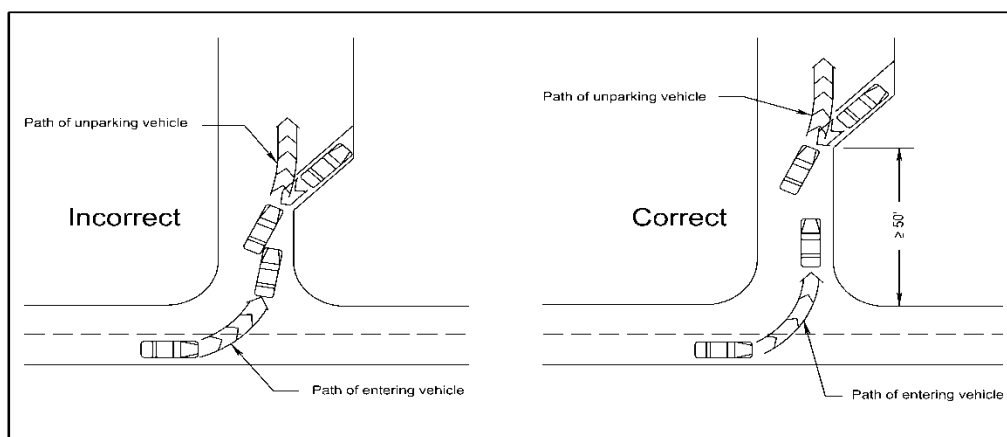

FIGURE 4-1A ENTRANCE THROAT DETAIL

* Rev. 7/11

To assure that entrances are designed to provide for safe and efficient movements, it is necessary to pay attention to critical dimensions and design features listed below.

- Radius of curved approach/exit of entrance.
- Flare size of angled approach/exit of entrance.
- Entrance Distance or spacing between entrances.
- Corner Clearance measured from a major intersection.
- Angle of entrance.
- Sight distance length of roadway visible to the driver required for vehicles to make safe movements.
- Entrance location in relation to other traffic features such as intersections, neighboring entrances, and median openings.
- Entrance throat distance needed into site to transition vehicles to the internal circulation system of the site.
- Right turn lanes to separate through and turning traffic on roadways to facilitate right turns into the entrance.

Entrance Pavement: The type and depth of the pavement shall be clearly indicated on the plans and/or permit application. The pavement of commercial entrances, turn lanes and tapers shall be of asphalt, concrete, or pavers that is of a construction comparable to the pavement of the adjacent roadway.

Entrance Grade*: The vertical alignment of all access locations should be designed to minimize vehicle bounce and prevent high-centering of vehicles with a maximum clearance of 4 inches. The maximum grade for an entrance should be 8% for all commercial entrances.

Steeper access entrances require District Administrators approval. A level area (maximum 2% grade) 20 feet in length should be provided at each access to ensure proper sight distance from the access. The level area is measured from the highway edge of pavement or from the back of sidewalk, whichever is appropriate based on site-specific conditions.

Entrance Cuts: The maximum vertical curve, crest or sag, shall have a maximum 4-inch vertical offset over a 10-foot chord length. A standard vertical curve should be designed for all entrance profiles that exceed 3.3%.

Entrance Drainage: Drainage shall be considered in the design of entrance grades. Roadways and curb-and-gutter sections that convey storm water runoff within the roadway prism should be designed in accordance with department standards. Site runoff into state right-of-way should be minimized.

Width * - All commercial entrances shall have a width sufficient for the particular land use and anticipated traffic flow with a minimum width of 16 feet for a one-way drive and 30 feet for a two-way drive. A two-way commercial entrance on a local street shall have a minimum width of 24 feet. The maximum width should be 20 feet for a one-way drive and 40 feet for a two-way drive.

* Rev. 1/11

These widths should be measured at right angles to the centerline of the entrance at the right-of-way line. Entrances with multiple lanes or median may require additional width. For subdivision streets, radii width and angle should be in accordance with Subdivision Street Design Guide in the Road Design Manual, Appendix B (1), at web link

<http://www.virginiadot.org/business/locdes/rdmanual-index.asp>

Radii * - All commercial entrances should have radii large enough to accommodate the largest design vehicle that will use it without creating undue congestion or hazard on the through highway (See Table 4-1). The minimum entrance radius allowed should be 25 feet and the minimum exit radius allowed should be 25 feet.

Where on-street parking is allowed near the commercial entrance, the effective radius for the entrance shall be used. Typically the effective radius will be the actual radius of the entrance curbing plus the width of the parking lane (for example 12.5 ft curb radius plus 8 ft wide parking lane resulting in an effective radius of 20.5 feet).

For subdivision streets, radii width and angle should be in accordance with Subdivision Street Design Guide in the Road Design Manual, Appendix B (1). See above web link.

Auxiliary Lanes and Tapers - When a land use will generate high traffic volumes, auxiliary lanes and tapers may be required. Auxiliary lanes and tapers shall be located within right-of-way.

Angled Entrances - When the property owner desires to construct dual commercial entrances at other than 90 degrees to the centerline of the road, an entrance on the right side as approaching should not have less than a 60 degree angle with the centerline of the road.

Profile - All commercial entrances should be built to a sidewalk elevation at the right-of-way line. Beyond the right-of-way line, the grade should not exceed 8 percent. Entrance configurations are shown starting at Figure 4-8.

Pedestrian Accommodation – Design criteria for accommodating sidewalks at commercial entrances (by providing pedestrian access routes across the entrance) are presented in diagram CG-11 in the Road and Bridge Standards at the following web link;

http://www.virginiadot.org/business/locdes/2008_standards_complete_sections.asp.

* Moderate * Volume Entrance – Certain design characteristics are reduced for a Moderate volume entrance along highways with shoulders. Site requirements are:

- Maximum highway vehicles per day: 5,000
- Maximum entrance vehicles per day: 200
- Maximum entrance percent truck trips of vehicles per day: 10%

For Moderate volume entrances the minimum entrance throat depth is 25 feet; minimum radii is 25 feet with curb/gutter or curbing not required; entrance width is 18 feet minimum and 30 feet maximum; and minimum angle of entrance is 60 degrees, 90 degrees preferred. See Figure 4-15 for Moderate volume entrance design illustration.

Limits of Maintenance Responsibility for Private and Commercial Entrances

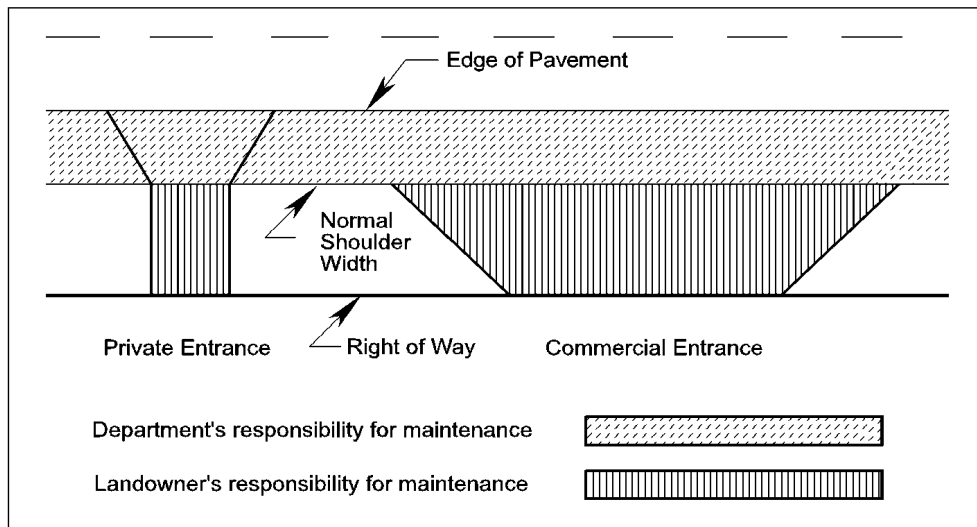

FIGURE 4-2

Commercial Entrance Location Criteria

Entrances shall be placed at locations that provide adequate intersection sight distance. These locations often occur at the top or bottom of inclines. In hilly areas, proper locations can be at a premium, and shared access might be necessary. Entrances shall not be placed within the functional area of any intersection. If however, existing entrances are located within the functional area of the intersection Part A of the Waiver Form AM-3 shall be completed and submitted to the District Location and Design Engineer for approval.* Greater spacing may be required due to stacking requirements of the approaches to the intersection. This can be particularly evident around signalized intersections.

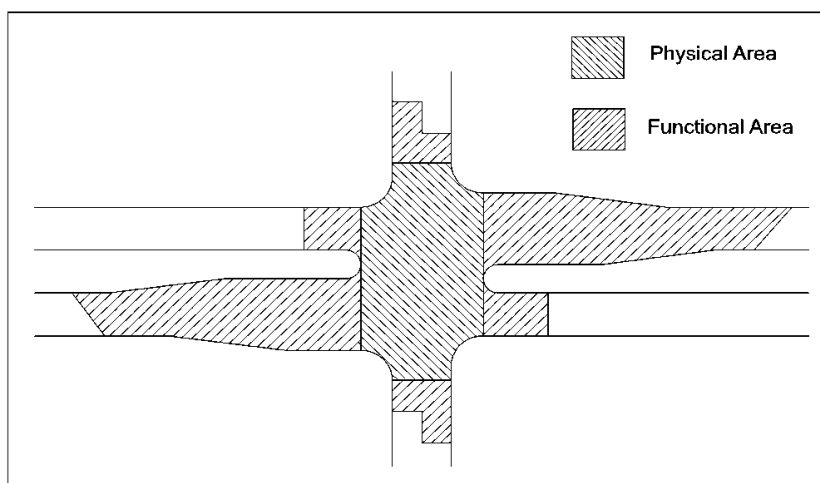
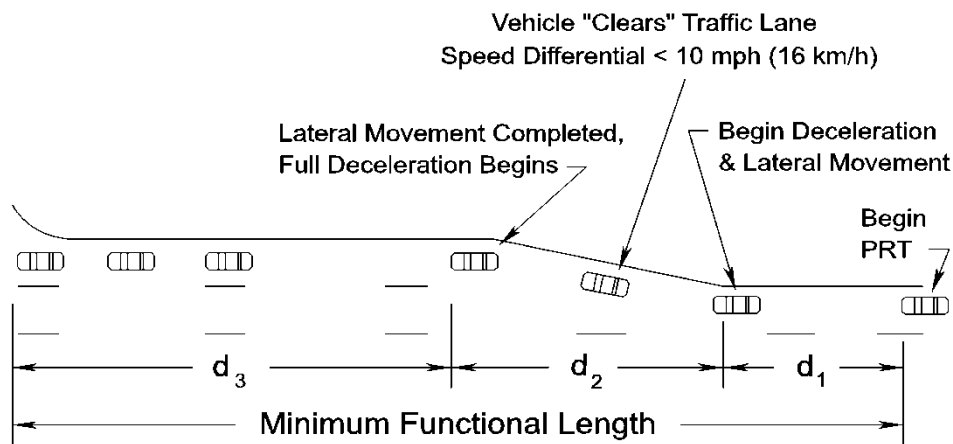

FIGURE 4-2A PHYSICAL AND FUNCTIONAL AREAS OF INTERSECTION

Source: FHWA, National Highway Institute Course No. 15255

* Rev. 7/12

AASHTO specifically states that “a driveway should not be located within the functional boundary of an intersection”. AASHTO does not present guidelines as to the size of the functional area of an intersection; however the size must be much larger than the physical area (see Figure 4-2A). The functional area should be composed of the distance traveled during the braking Perception-Reaction Time plus the distance required to move laterally and come to a stop plus any required storage length (see Figure 4-3). The minimum maneuver distance assumes that the driver is in the proper lane and only needs to move laterally into a right turn or left turn bay.



d_1 = distance traveled during perception-reaction time (PRT) (2.5 sec. x Design Speed in ft/sec.)

d_2 = distance traveled while driver decelerates and maneuvers laterally (Taper length see Figure 3-1)

d_3 = storage length (See Figure 3-1)

FIGURE 4-3 FUNCTIONAL AREA OF INTERSECTION

Source: 2011^{*} AASHTO Green Book

Commercial Entrance Sight Distance

Entrances shall be located to provide adequate intersection sight distance. Intersection sight distance criteria are illustrated below and the sight distance requirements are presented in Table 2-7.* The line of sight establishes the boundary of a sight triangle within which there should be no sight obstruction. At any location where the sight line leaves the right-of-way, a permanent easement must be maintained, and the area must be graded and landscaped such that sight distance is not compromised, for a commercial entrance to be approved. (For an Appeals Process, see Access Management Regulations: (24VAC30-72-50 B & 24VAC30-73-50 B).

Offsets: Improvements on public or private property adjacent to the right-of-way should be located so that parking, stopping, and maneuvering of vehicles within the highway right-of-way will not occur. The minimum distance from the right-of-way line for all structures and sight obstructions should be the clear zone. At all entrances and intersections, an adequate sight triangle shall be provided. The minimum setback point for the sight triangle should be 14.5 feet from the near-side extended highway edge of pavement.

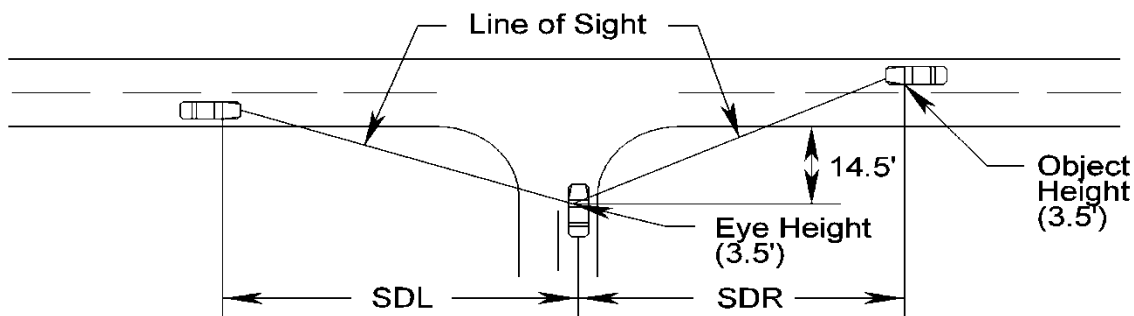

SDR = Sight Distance Right (For a vehicle making a left turn)
 SDL = Sight Distance Left (For a vehicle making a right or left turn)

All site plans for proposed developments shall show the location of all proposed and existing entrances within the area of the proposed development. The location of all of the proposed entrances shall be reviewed to determine if proper spacing will be maintained.

Restricting Left Turn Movements at Commercial Entrances

The most effective way to prevent left turn movements at entrances is through the use of restrictive medians. Where space for a raised median is available within the road (AASHTO recommends a minimum median width of 4 feet), it can be installed along the front of the entrance for a sufficient distance to prevent left turns (see Medians in section 3 for additional information). Another alternative when there is not enough space for a raised median is the use of flexible traffic posts with reflective striping to serve as a visual and physical barrier to left turn ingress and egress at an entrance. Finally, although less effective than restrictive medians, channelization islands can be installed within the commercial entrance throat to prevent left turn ingress and/or egress movements to create a right-in and/or right-out entrance on an undivided highway. Figure 4-5 presents illustrations of commercial entrance channelization island options.

* Rev. 7/10

Commercial Entrance Channelization Island Options

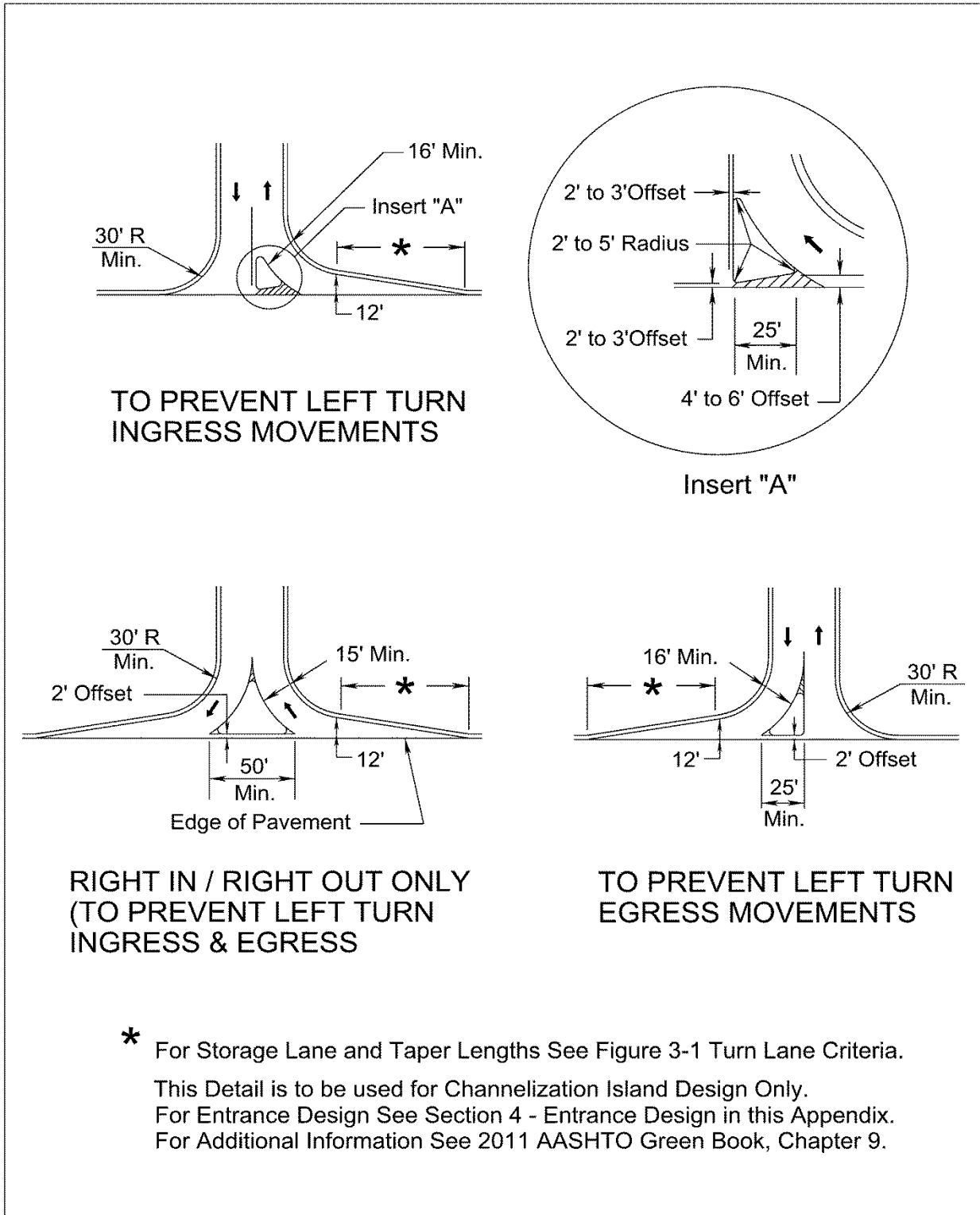

FIGURE 4-5 COMMERCIAL ENTRANCE CHANNELIZATION ISLAND OPTIONS*

* Rev. 7/12

Commercial Entrance Spacing

Access management increases the spacing between entrances, thus reducing the number and variety of events to which drivers along the corridor must respond. Close spacing between unsignalized entrances forces the driver to watch for ingress and egress traffic at several locations simultaneously. Increased spacing translates into fewer accidents, savings in travel time, and preservation of corridor capacity.

Entrances should be located to limit interference with the free movement of roadway traffic, and to provide the most favorable sight distance and entrance grade. No direct access entrance should be located in the operational area of a signalized intersection. Entrance spacing shall be based on spacing standards in Table 2-2.

Corner Clearance on a Minor Side Street

It is important to think of the operational impacts of entrance placement on side streets where the side streets intersect with major roadways. The major roadway will have the higher functional classification or if the same classification will have the higher traffic volume. Corner clearance does not apply to the intersection of two functionally classified local streets.* The operational character of the traffic turning from the main roadway onto the minor side street as well as the expected queues on the side street, help determine how far to place the closest side street entrance from the intersection.

Moving the basic entrance conflict area away from the vicinity of an intersection can be accomplished by regulating the distance between a crossroad intersection and the nearest entrance location. The intent is to prevent queued vehicles from backing up into the highway or blocking entrances near the intersection. The major effect is that vehicles will be delayed less by standing queues at signalized intersections.

Corner clearance is defined as the distance, measured perpendicular to the major roadway, from the nearest edge of an entrance on the minor side street to the nearest edge pavement of the major roadway intersection.

In most instances, the minimum corner clearance will be governed by the intersection sight distance. Minimum entrance setbacks should be considered at individual intersections, and should be based on typical queue lengths that still allow sufficient movement to and from an entrance.

It is important to note that the Table 2-2 entrance and intersection spacing standards are measured from the centerlines of the intersection and the entrance rather than edge of pavement. As a result, the Table 2-2 spacing measurement may result in a distance that is less than the corner clearance. The corner clearance distance will apply where it is greater than the Table 2-2 spacing standard to protect intersection operation.

* Rev. 1/12

Similar to the placement of an entrance on the main roadway, conflicts for the existing vehicles for the side street entrance must be considered. Figure 4-4 illustrates the concept of corner clearance.

For the right turn out of the side street entrance (flow A), the vehicle approaching from the left (flow C) must be considered. The greater the radius (R) for right turning vehicles from the main roadway, the faster they will be approaching the side street entrance. For the driver exiting the side street entrance to go left (flow B) or right (Flow F) or to enter the opposite entrance (Flow E), the length of the queue at the main intersection must be considered to assure there is enough room that the entrance will not be blocked by queue D.

The minimum downstream corner clearance is 225', which equals the intersection sight distance for 20 mph (see Table 2-7). Additional length will be required as directed by the Engineer at the District or Residency if the intersection is signalized or future signalization is anticipated.

The minimum upstream corner clearance will be the greater of $225' + W$ or the queue D.

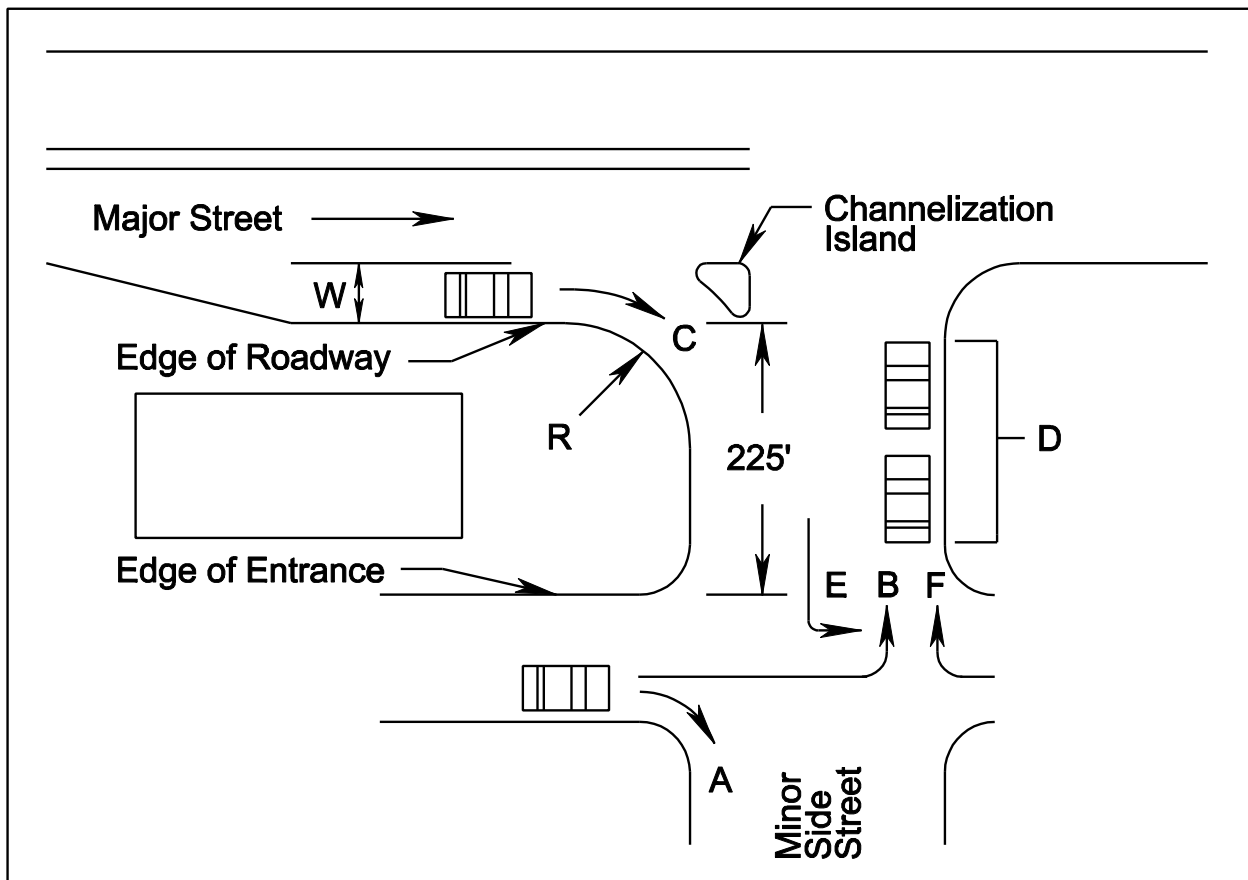
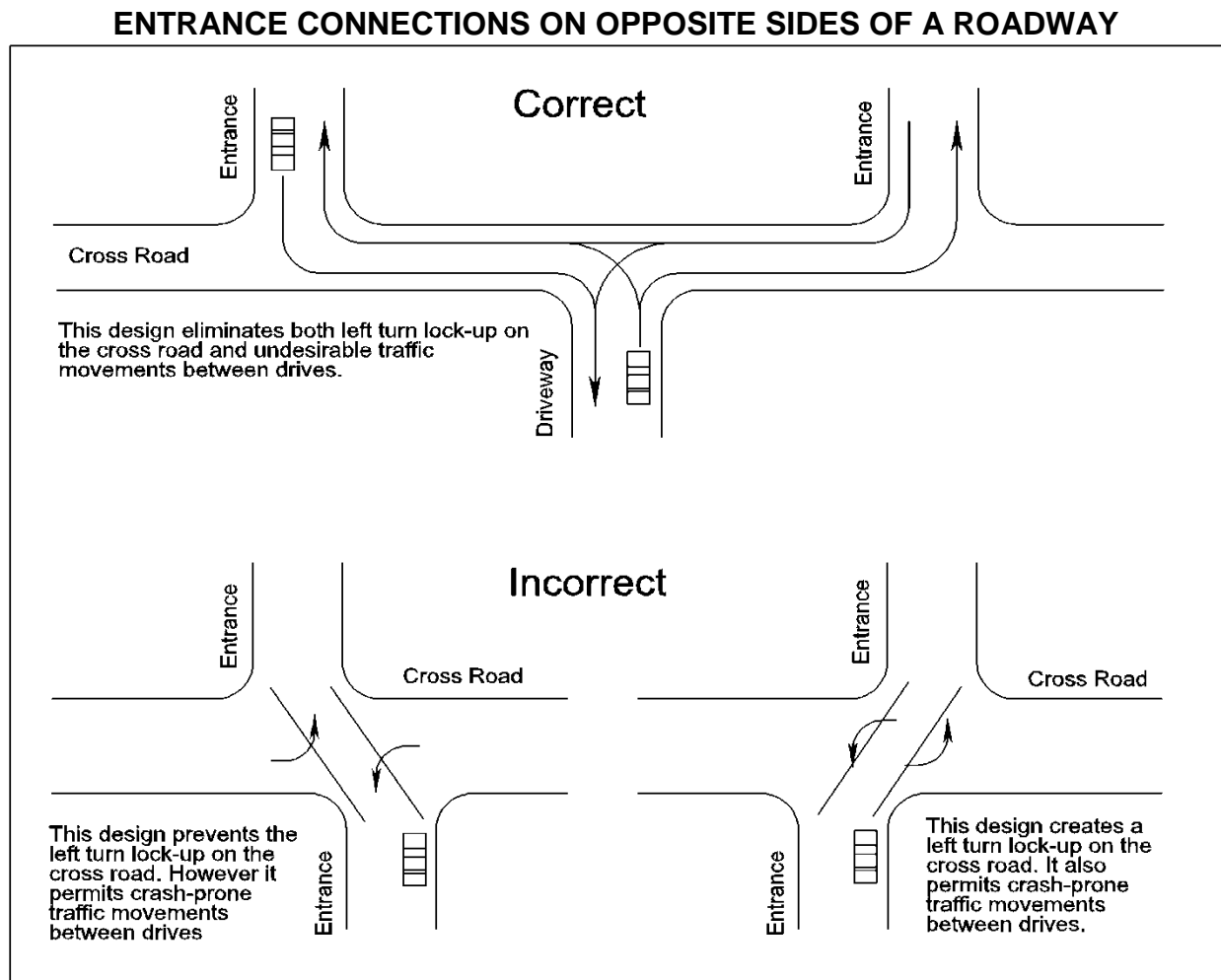

FIGURE 4-4 CORNER CLEARANCE

Entrance Connections on Opposite Sides of a Roadway

Closely spaced entrances on opposite sides of an undivided roadway or a roadway with two-way left-turn lanes (TWLTL) result in “jog” maneuvers, instead of separate and distinct left-turn and right-turn maneuvers (see below). They can also result in conflicting left-turns. Entrances on opposite sides of a roadway shall be offset a sufficient distance to assure that entrance left turning movements do not conflict.* Separation of the access connections results in their functioning as separate T-intersections (3-way intersection) that have relatively low crash potential.



Source: Driveway Handbook, dated March 2005, Florida Dept. of Transportation.

FIGURE 4-6 ENTRANCE CONNECTIONS ON OPPOSITE SIDES OF A ROADWAY

* Rev. 7/10

Entrance Consolidation (Shared Use Entrances)

Shared Use Entrances are used to reduce the number of access points along a corridor while maintaining reasonable access to adjacent land uses. A Shared Use Entrance generally serves only two parcels.

A shared use entrance may be constructed if both property owners abutting a common property line agree. This encourages adjacent property owners to construct shared entrances in lieu of separate ones. Strategies for implementing this access control measure include closing existing entrances or authorizing joint-use ones. The feasibility of this measure should be viewed at the preliminary, site plan review and the permit-authorization stages. A shared access drive will result in a reduction in the concentration of entrances along a roadway, thus reducing the frequency and severity of conflicts.

The physical means by which access can be consolidated between two adjacent properties involves the construction of a joint-use entrance between the two properties. It is recommended that both property owners own the shared access drive. That is, the entrance should straddle the property line dividing the two establishments. The resulting joint-use parking area should be accompanied by an efficient internal circulation plan.

Shared Entrances and Internal Site Interconnection

If a group of smaller developments share access, the driver needing to turn left across heavy volumes can usually find an access that is signalized, allowing safer left turns. Having good cross parcel access also maximizes the number of well designed unsignalized entrances that have good visibility and are located in such a way to take advantage of sufficient gaps in traffic from a nearby signal. Joint entrances and cross access especially help the small corner lots and out parcels. On small corner parcels left turn accessibility may be a problem and access to parcels may be limited to right in/right out or similarly restricted movements.

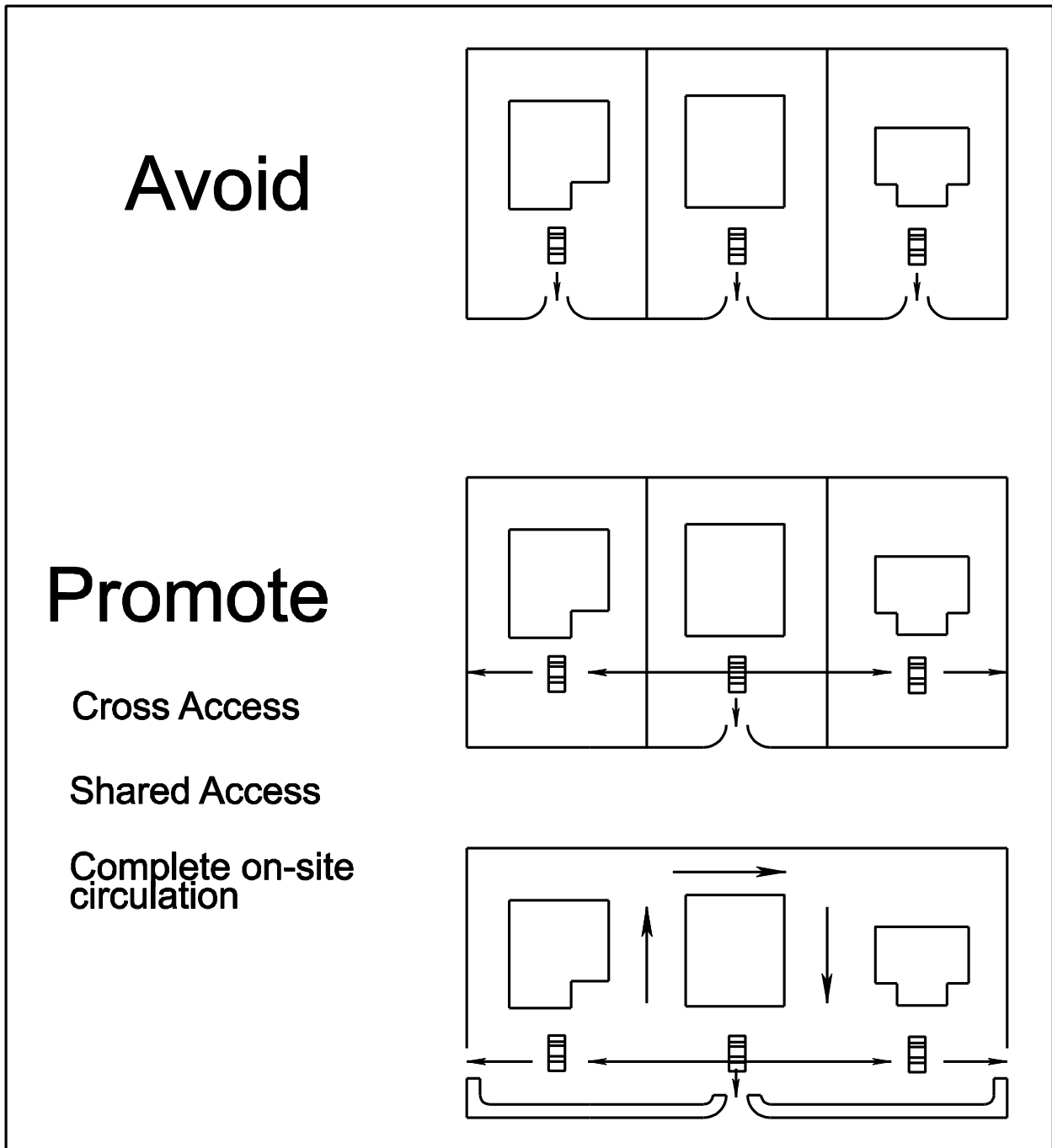

Avoid

Promote

Cross Access

Shared Access

Complete on-site circulation

Source: FDOT- Driveway Handbook, Dated March, 2005

FIGURE 4-7 SHARED ENTRANCE AND INTERNAL SITE CONNECTION

Frontage Roads

Frontage or service roads may be constructed by VDOT where justified by existing or anticipated traffic needs, right-of-way requirements, etc. within funds available.

Where frontage or service roads have not been constructed by VDOT, the Department may cooperate with others in the construction of service roads to promote highway safety and provide suitable locations for public utility services.

VDOT may furnish assistance if the construction of a frontage road will provide significant public service and eliminate undesirable ingress and egress through the establishment of safe and properly spaced access points.

Frontage roads constructed in cities, municipalities, or towns of more than 3,500 or along Primary routes in those counties which maintain their Secondary roads shall meet all minimum VDOT standards or the standards of the city, town or county as provided by ordinance.

When frontage or service roads are constructed by someone other than VDOT, the following conditions shall apply:

If the road is Constructed on...	Then the construction or use must...	And...
Existing State Right-of-Way	Conform to such rules regulations, standards, specifications, and plans as may be approved by VDOT and authorized by issue of a permit	The cost of the construction is fully borne by others.
Land Outside Existing State Right-of-Way	Conform to such rules, regulations, standards, specifications, and plans, as may be approved by VDOT	The land must be dedicated to public use if the road is to be accepted into the highway system and maintained by VDOT.
Then...	VDOT will accept as a part of the appropriate highway system, those service roads constructed by others in accordance with above criteria.	

VDOT will maintain the roads in accordance with maintenance standards established for such classes of roads.

The cost of maintaining frontage roads shall be charged to the route and section of mainline highway which it serves unless it forms an integral section of another route.

Source: Code of Virginia, [15.2-2265](#) and [33.1-61](#)

Entrances Affected by Highway Construction Projects

Title [33.1-89](#) of the Code of Virginia, as amended, requires that projects have the alignment, profile, and grade of **commercial and*** private entrances shown on plans.

This information is to be shown as follows:

1. When the proposed entrance is to be placed in the same location as the existing entrance, no alignment will be shown. The proposed entrance will be shown graphically. A note is to be included on the general notes sheet as follows: "When no baseline alignment is shown for a proposed entrance, the entrance is to be constructed in the same location as the existing entrance."
2. Where a proposed entrance is to be on a location different from the existing, the proposed location will be shown graphically on the field inspection plans. After the field inspection party has reviewed the proposed location, the Right of Way and Utilities Division will contract the property owner and determine that the proposed location is satisfactory or that the property owner desires some other location. The designer will then request the centerline and profile to be run by the survey party when this cannot be secured from existing notes. This alignment is to be shown on the plans.
3. A profile and proposed grade is to be shown for each entrance where it is necessary to re-grade on existing or new location. The survey party runs a profile along every existing entrance using a data collector and converting the information for placement into a graphics file. The profile is generally run along the center of the existing entrance, although usually no alignment is taken. The proposed grade can be a spline grade with an approximate percent of grade shown. The proposed grade will begin at the edge of shoulder; back of curb; or back of sidewalk, sidewalk space, or bikeway whichever is the outermost permanent construction. If it is necessary to use some other beginning point, it should be identified on the profile.

It is desirable that projects with a large number of entrances contain a separate profile sheet or sheets devoted to entrances.

4. The above information does not apply to "No Plan" Projects.

Title [33.1-199](#) of the Code of Virginia, Replacing entrances destroyed by Commissioner. The Commonwealth Transportation Commissioner shall review the existing access to any parcel of land having an entrance destroyed in the repair or construction of the systems of state highways and shall provide access to the systems of state highways in a manner that will serve the parcel of land and ensure efficient and safe highway operation.

* Rev. 7/10

1. Whenever plans have been prepared for a proposed improvement and submitted to the district for field inspection, the plans will show the entrances in place as called for by the engineering information at the time the plans were prepared. The field inspection team shall make a close inspection of all entrances on the project and a determination will be made as to which entrances are to be replaced based on the entrance spacing standards in Table 2-2, 2-3, or 2-4 in order to protect the safety, integrity, and operational characteristics of the highway.
2. In reviewing the plans, there may be instances where a landowner now has access to his property by reason of the fact that he is able to drive from the highway surface to this adjoining property, particularly in farming operations, in order to obtain access to various fields within the farm. This must be carefully studied and, if the farm is so arranged that this is found to be true, the provisions are to be made to provide field entrances as conditions would require.
3. No additional entrances are to be called for or shown on the plans and certain entrances may need to be consolidated or relocated.
4. The right of way is to be appraised and acquired in accordance with the approved plans and the entrances that are shown thereon. (Should it be discovered at the appraising or negotiating stage that an existing entrance has been overlooked or added by the owner since the time of field inspection, then, of course, this entrance will be replaced.) There will, of course, be instances when the owner requests the construction of an entrance to a property where no access exists or for the construction of an additional entrance. When this occurs, the owner's request can be complied with if it is determined that construction of the entrance is economically justified and the District Administrator and Regional* Traffic Engineer give their approval for the construction thereof.
5. The type of entrance (Type I, II, III, IV) to be constructed will be determined by the existing conditions at the time of construction. The applicable details shown as CADD Cell "PCENTR" are to be placed on the typical section sheet, see http://www.virginiadot.org/business/locdes/vdot_cadd_manual.asp.
6. For exceptions or waivers to spacing standards or other entrance criteria on highway construction projects, please see pages F-30 and F-31 of this Appendix.

Commercial Entrance Design to Serve A Private Subdivision Road / Street

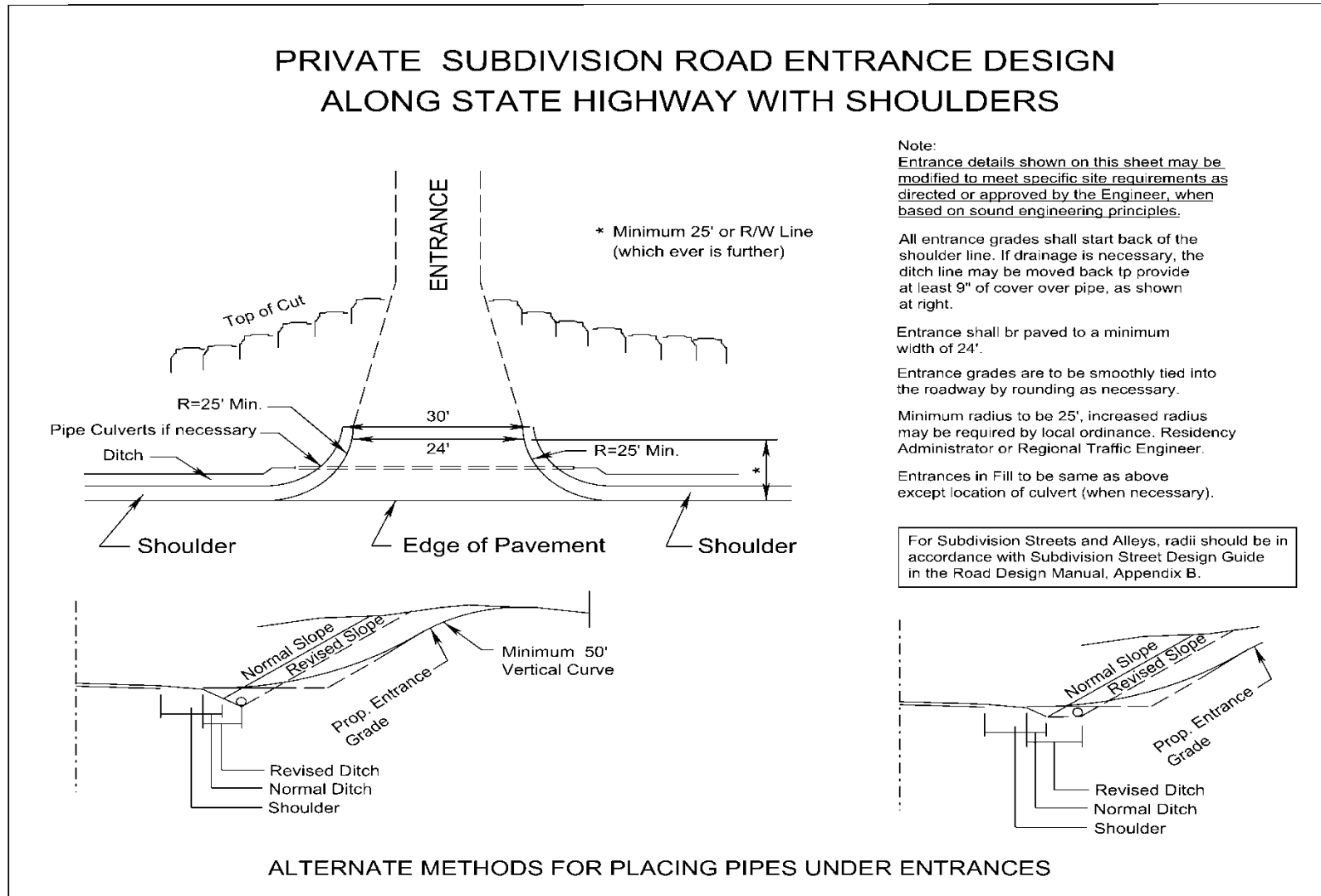

FIGURE 4- 8 COMMERCIAL ENTRANCE DESIGN TO SERVE A PRIVATE SUBDIVISION ROAD / STREET

Note: All entrance design and construction shall accommodate pedestrian and bicycle users of the highway in accordance with the Commonwealth Transportation Board's "Policy for Integrating Bicycle and Pedestrian Accommodations".

Commercial Entrance Designs along Highways with Shoulders

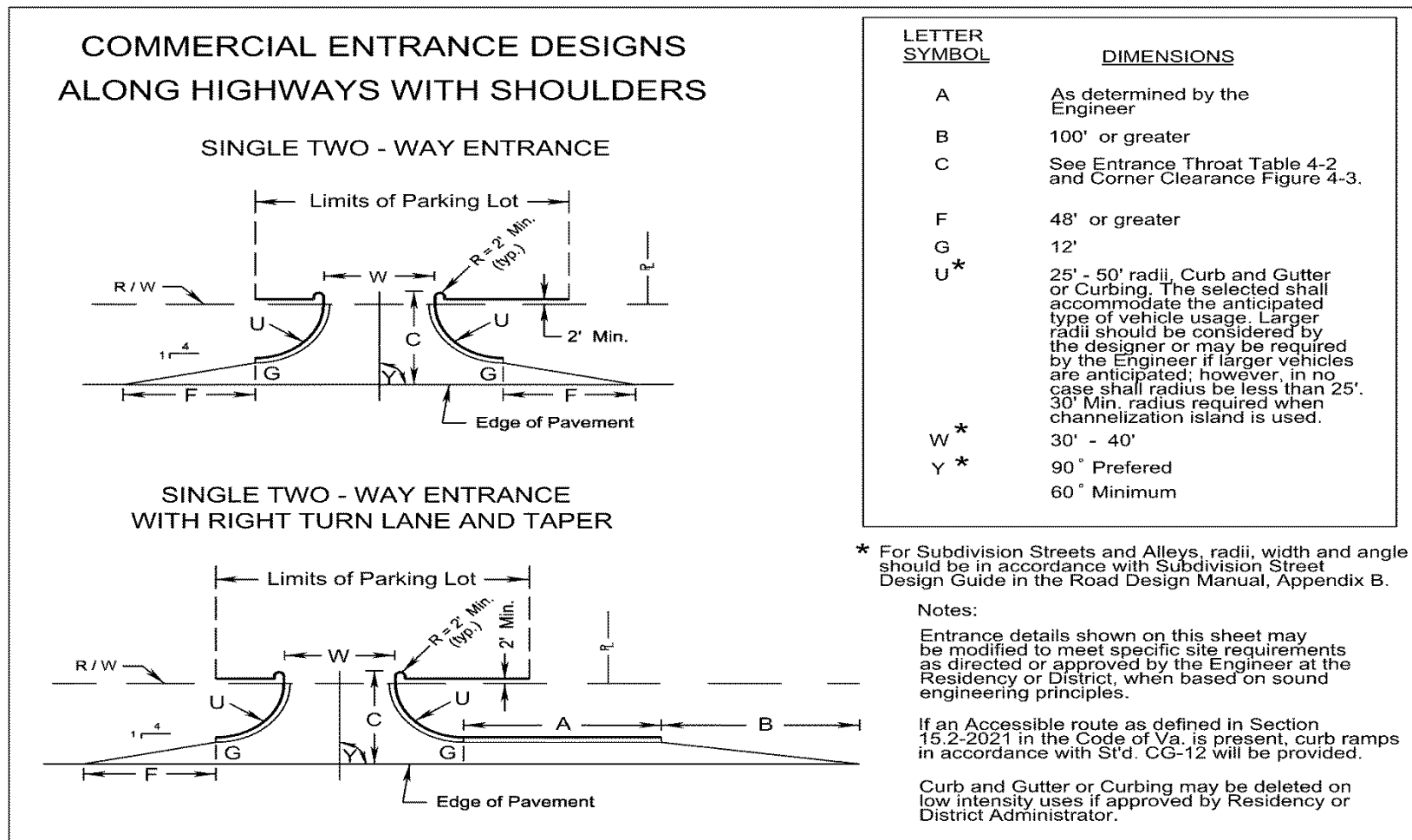

FIGURE 4- 9 COMMERCIAL ENTRANCE DESIGNS ALONG HIGHWAYS WITH SHOULDERS*

Note: All entrance design and construction shall accommodate pedestrian and bicycle users of the highway in accordance with the Commonwealth Transportation Board's "Policy for Integrating Bicycle and Pedestrian Accommodations".

* Rev. 7/12

Commercial Entrance Designs along Highways with Curb and Gutter

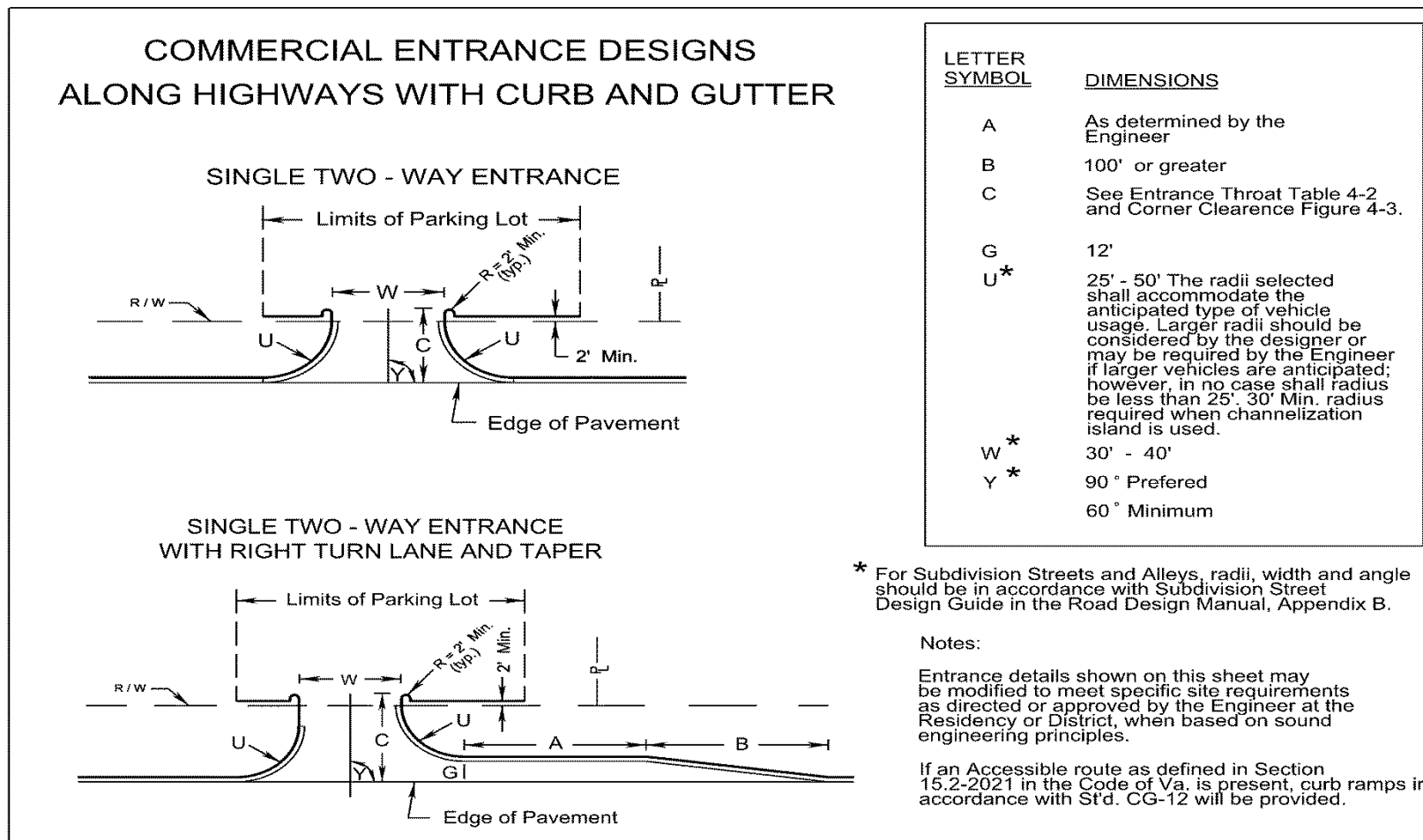

FIGURE 4-10 COMMERCIAL ENTRANCE DESIGNS ALONG HIGHWAYS WITH CURB AND GUTTER*

Note: All entrance design and construction shall accommodate pedestrian and bicycle users of the highway in accordance with the Commonwealth Transportation Board's "Policy for Integrating Bicycle and Pedestrian Accommodations".

* Rev. 7/12

Commercial Entrance Design along Local Streets with Curb and Gutter or Shoulders

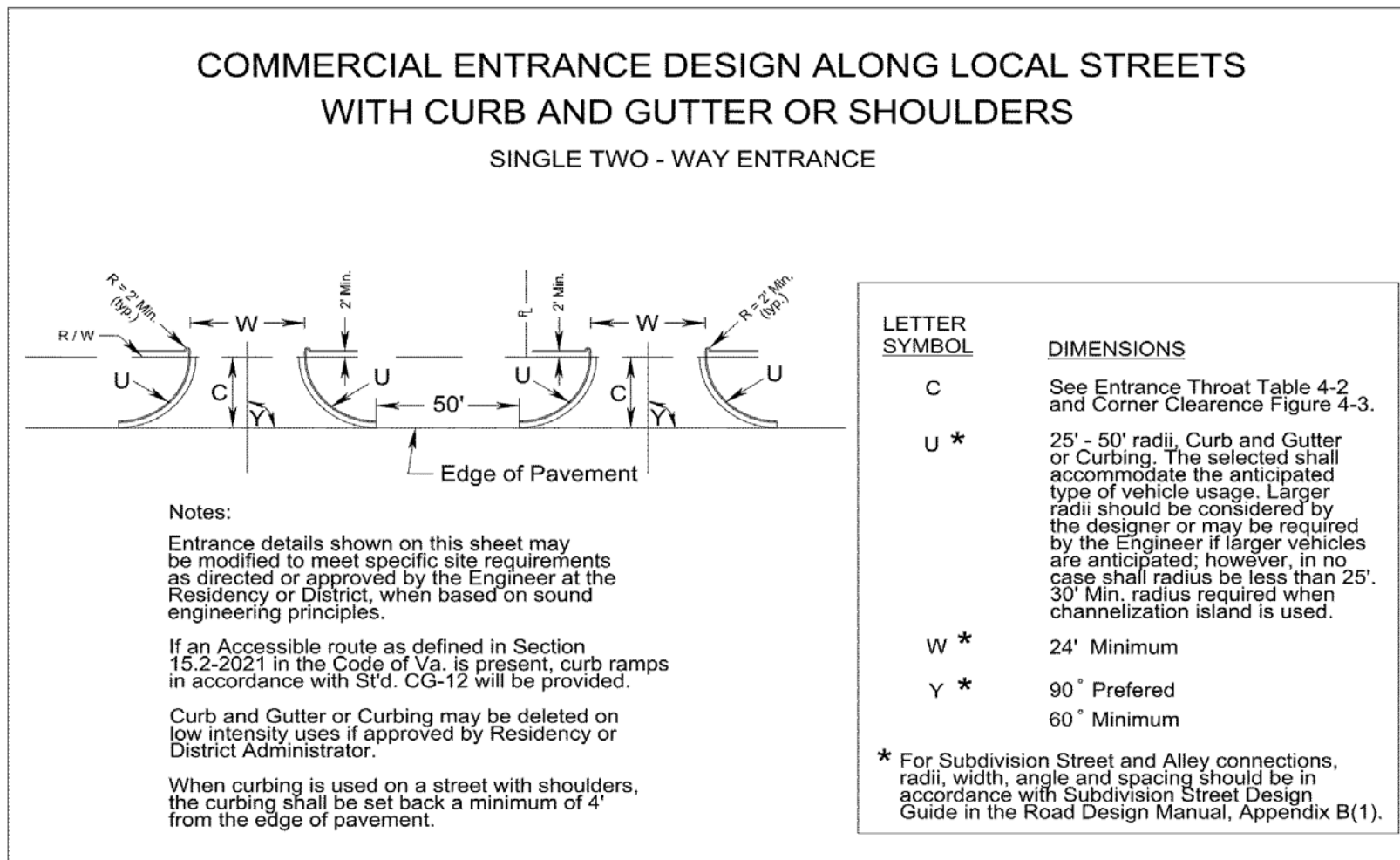

FIGURE 4-11 COMMERCIAL ENTRANCE DESIGNS ALONG LOCAL STREETS*

Note: All entrance design and construction shall accommodate pedestrian and bicycle users of the highway in accordance with the Commonwealth Transportation Board's "Policy for Integrating Bicycle and Pedestrian Accommodations".

* Rev. 7/12

Commercial Entrance Designs along Highways with Shoulders at Intersection

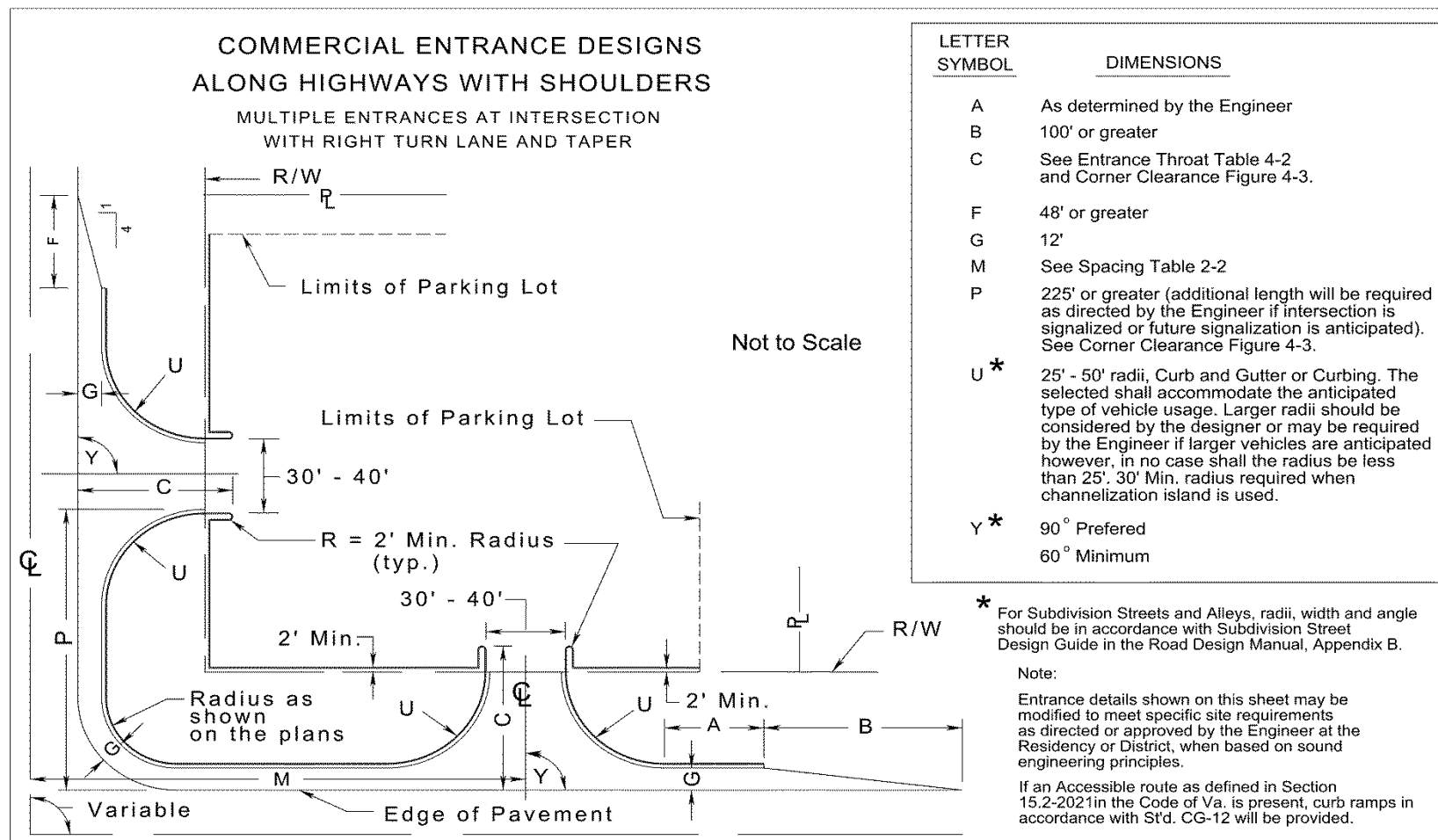

FIGURE 4-12 COMMERCIAL ENTRANCE DESIGNS ALONG HIGHWAYS WITH SHOULDERS AT INTERSECTION*

Note: All entrance design and construction shall accommodate pedestrian and bicycle users of the highway in accordance with the Commonwealth Transportation Board's "Policy for Integrating Bicycle and Pedestrian Accommodations".

* Rev. 7/12

Commercial Entrance Designs along Highways with Curb and Gutter at Intersection

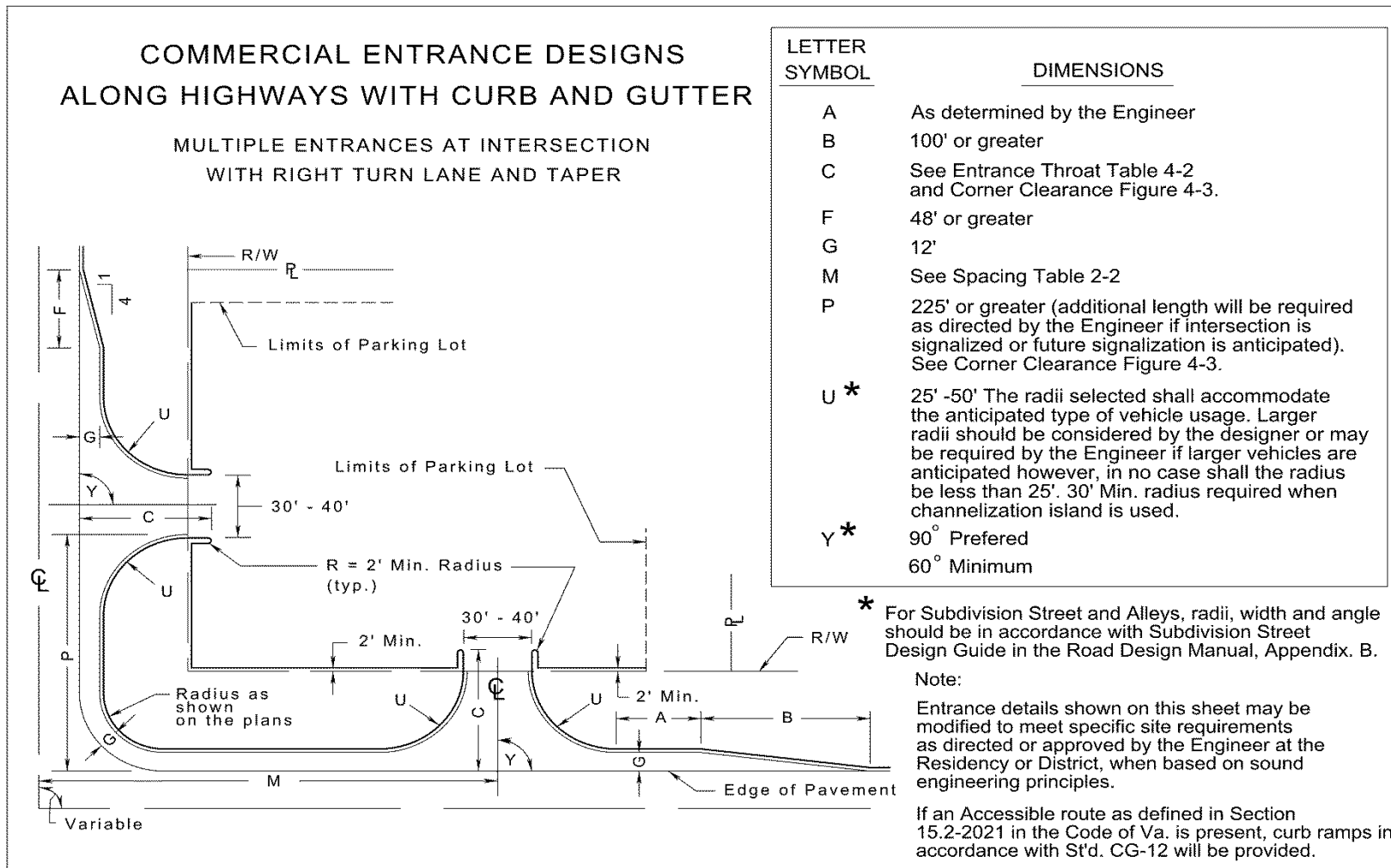

FIGURE 4-13 COMMERCIAL ENTRANCE DESIGNS ALONG HIGHWAYS WITH CURB & GUTTER AT INTERSECTION*

Note: All entrance design and construction shall accommodate pedestrian and bicycle users of the highway in accordance with the Commonwealth Transportation Board’s “Policy for Integrating Bicycle and Pedestrian Accommodations”

* Rev. 7/12

Commercial Entrance Designs to Serve Drive-In Type Businesses

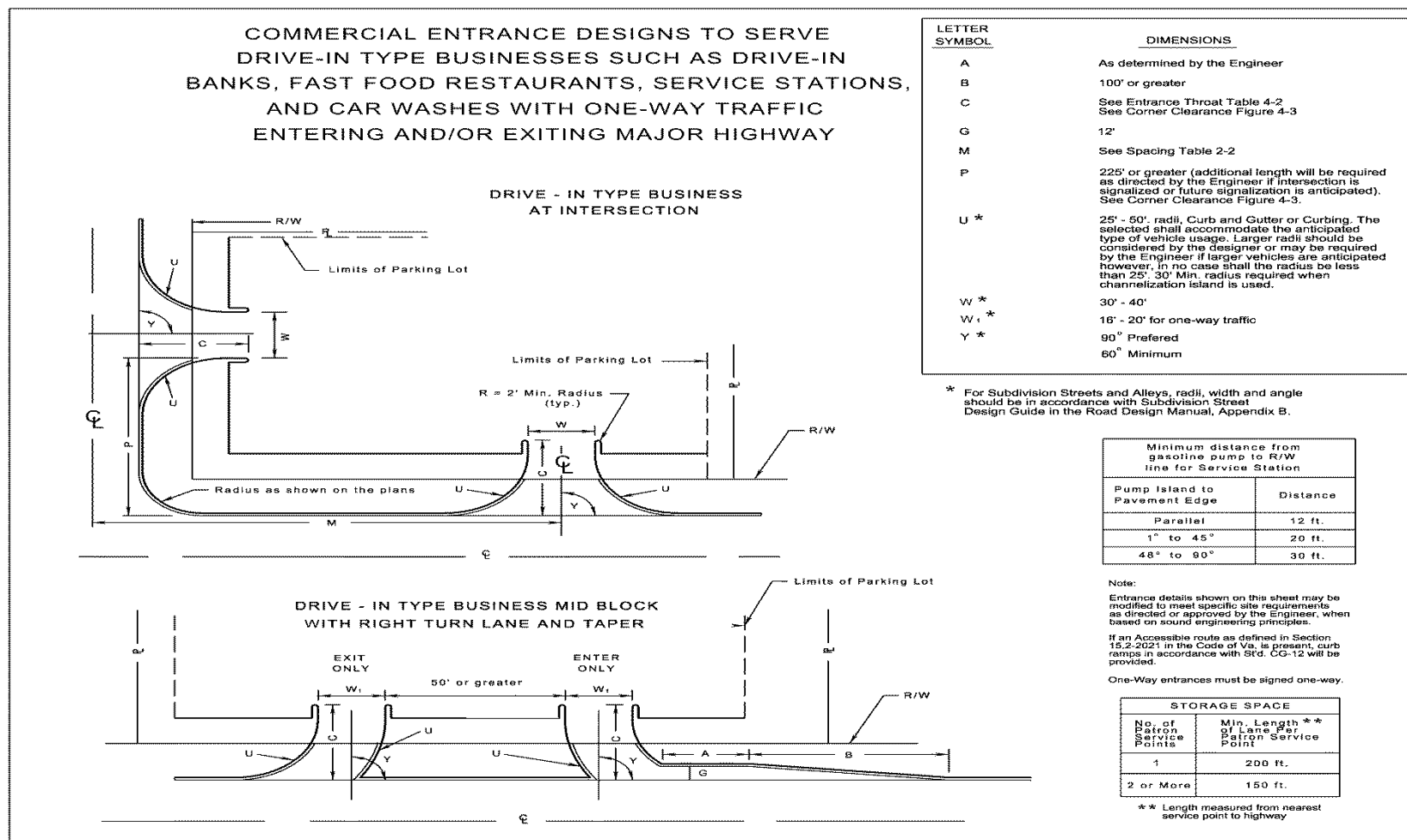

FIGURE 4-14 COMMERCIAL ENTRANCE DESIGNS TO SERVE DRIVE-IN TYPE BUSINESSES*

Note: All entrance design and construction shall accommodate pedestrian and bicycle users of the highway in accordance with the Commonwealth Transportation Board's "Policy for Integrating Bicycle and Pedestrian Accommodations".

* Rev. 7/12

Moderate Volume Commercial Entrance Design along Highways with Shoulders

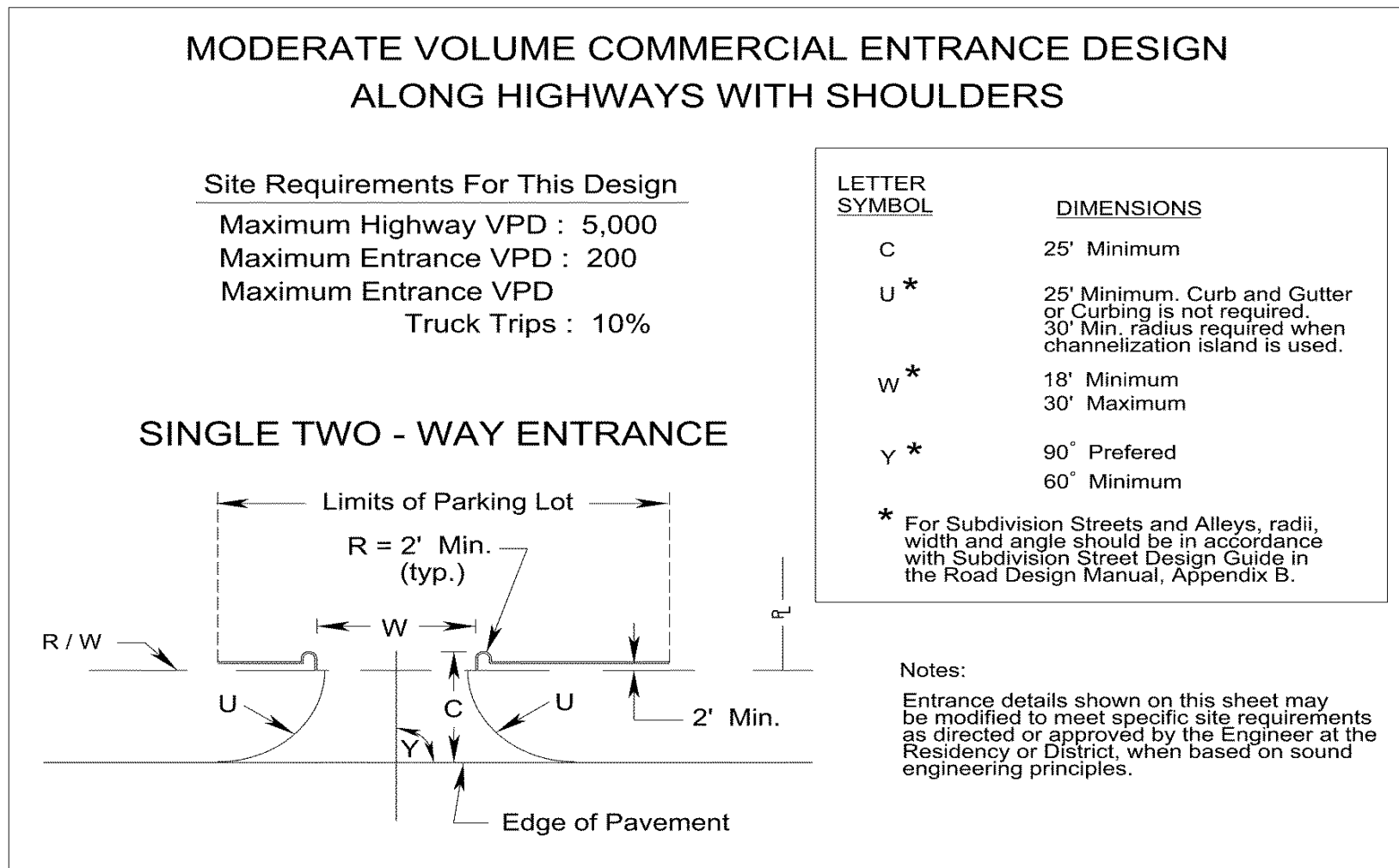

FIGURE 4-15 MODERATE VOLUME COMMERCIAL ENTRANCE DESIGN ALONG HIGHWAYS WITH SHOULDERS*

Note: All entrance design and construction shall accommodate pedestrian and bicycle users of the highway in accordance with the Commonwealth Transportation Board's "Policy for Integrating Bicycle and Pedestrian Accommodations".

* Rev. 7/12

BIBLIOGRAPHY

American Association of State Highway and Transportation Officials (AASHTO), A Policy on Geometric Design of Highways and Streets, Washington, D.C. Dated 2011*.

Transportation Research Board (TRB), National Research Council, Urban Street Symposium, Circular E-C019, Dated December 2000.

Transportation Research Board (TRB), National Research Council, Transportation Research Circular Urban Street Symposium Conference Proceedings, Dated June 28-30, 1999.

Transportation Research Board of The National Academies, Access Management Manual, Dated 2003.

Transportation Research Board (TRB), National Research Council, National Cooperative Highway Research Program, NCHRP Report 348, Access Management Guidelines for Activity Centers, Dated 1992.

Transportation Research Board (TRB), National Research Council, Transportation Research Record, No. 1385, Highway and Facility Design, Intersection and Interchange Design, Dated 1993.

Institute of Transportation Engineers (ITE), Guidelines For Urban Major Street Design, Dated 1984.

Institute of Transportation Engineers (ITE), Sidewalk Design Guideline and Existing Practices, Part 1, Dated July 1999.

Institute of Transportation Engineers (ITE), Issue Briefs 13, Access Management: A Key to Safety and Mobility, Dated April 2004.

Oregon department of Transportation (ODOT), Right-In Right-Out Channelization, Dated October 4-7, 1998.

Iowa Department of Transportation (IDOT), Design Manual, Chapter 5 Roadway Design 51-Access Management, Dated October 17, 2006.

Fulton County Driveway Manual (Georgia), Adopted May 2005.

New Mexico State Highway and Transportation Department, State Access Management Manual, Dated September 20, 2001.

* Rev. 7/12

Florida Department of Transportation (FDOT), System Planning Office, Driveway Handbook, Dated March 2005.

Florida Department of Transportation (FDOT), Florida Intersection Design Guide, Dated 2002.

Florida Department of Transportation (FDOT), Rules of the Department of Transportation, Chapter 14-97, State Highway System Access Management Classification System and Standards, November 27, 1990.

Florida Department of Transportation (FDOT), Manual of Uniform Minimum Standards for Design, Construction and Maintenance for Streets and Highways (Topic #625-000-025), Dated July 20, 2006.

Michigan Department of Transportation (MDOT), The Access Management Guidebook, Date Unknown (After 2000).

Transportation Research Board (TRB), National Research Council, Transportation Research Circular No. 456 Driveway and Street Intersection Spacing, Dated March 1996.

Transportation Research Board (TRB), National Research Council, National Cooperative Highway Research Program, NCHRP Report 420, Impacts of Access Management Techniques, Dated 1999.

Transportation Research Board (TRB), National Research Council, National Cooperative Highway Research Program, NCHRP Report 383, Intersection Sight Distance, Dated 1996.

New Jersey Department of Transportation (NJDOT), Roadway Design Manual, Section 6 at-Grade Intersections, Date Unknown.

Fourth National Access Management Conference, An Introduction To Access Management, Dated August 2000.

FHWA Functional Classification Guidelines, Concepts, Criteria and Procedures, Dated 1999.

Kentucky Transportation Cabinet, Highway Design, Dated January 2006.

Nashua Regional Planning Commission (New Hampshire), Access Management Guidelines, Dates April 2002.

Illinois Department of Transportation (IDOT), Bureau of Design and Environment Manual, Dated December 2002.

Institute of Transportation Engineers (ITE), Technical Committee 5B-13, Institute of Transportation Engineers, Guideline for Driveway Design and Location, Dated 1985.

Federal Highway Administration (FHWA), National Highway Institute, Access Management, NHI Course No. 15255, Dated October 1991.

Massachusetts Highway Department, Project Development and Design Guide, Dated 2006.

Maryland State Highway Administration, Managing Highway Access, Dated January 2001.

North Carolina Department of Transportation, Strategic Highway Corridors, Dated Unknown.

South Dakota Department of Transportation, Road Design Manual, Dated 1997.