

## **APPENDIX F**

# **Access Management Design Standards for Entrances and Intersections: Principal Arterials**

**July 1, 2008**

## PREFACE

The 2007 General Assembly unanimously approved legislation proposed by the Governor to direct VDOT's commissioner to develop, solicit public input on, and publish access management regulations and standards by December 31, 2007 to become effective July 1, 2008. The legislative goals for access management are to:

- Reduce traffic congestion,
- Enhance public safety by decreasing traffic crash rates,
- Support economic development by promoting the efficient movement of people and goods,
- Reduce the need for new highways and road widening by maximizing the performance of the existing state highways, and
- Preserve the public investment in new highways.

To assure that a wide variety of viewpoints were considered, multiple techniques were used to gain public input on the draft regulations and standards: a policy advisory committee, a public comment period, an access management Web site with an email form for the public to submit their comments, and a public hearing. The commissioner approved and published the access management regulations and standards in December.

During the 2008 General Assembly session legislation was enacted to require that the regulations and standards be implemented in phases according to a highway's functional classification. The first phase allows the access management regulations and standards for VDOT highways classified as principal arterials to take effect July 1, 2008. During the second phase, the regulations and standards developed during 2007 for other functionally classified highways will undergo extensive public evaluation in accordance with the Administrative Process Act, to become effective October 1, 2009.

As a result, this document establishes standards for the design of intersections, turning lanes, and entrances and spacing standards for entrances, intersections, crossover medians, and traffic signals that only apply to principal arterials. A map that identifies the state highways designated as principal arterials along with a list of such highways by locality is available on the VDOT web at <http://www.virginiadot.org/projects/accessmgt/default.asp>.

These regulations and standards apply to principal arterials maintained by VDOT that have not been to public hearing prior to July 1, 2008.

The existing standards for entrances, turning lanes, and intersections in Appendix C of the Road Design Manual and the design illustrations for commercial entrances in the "Minimum Standards of Entrances To State Highways", Section 24 VAC 30-71-160 will continue to apply to all state highways with other functional classifications (highways that are not identified on the VDOT web site map or list of principal arterials).

## Table of Contents

<b>DEFINITIONS .....</b>	<b>1</b>
<b>SECTION 1- INTRODUCTION.....</b>	<b>6</b>
Access Management Concepts .....	6
Functional Classification .....	7
Urban and Rural Area Definitions.....	10
Functional System Characteristics .....	11
<b>SECTION 2 – INTERSECTION DESIGN; SPACING STANDARDS .....</b>	<b>12</b>
Intersection Design Objectives.....	12
Intersection Design Principles.....	13
Minimum Angle of Intersections.....	21
Signalized Intersection Spacing .....	21
Unsignalized Intersection Spacing.....	24
Spacing Standards for Commercial Entrances, Intersections, & Crossovers..	25
Spacing Standards for Commercial Entrances and Intersections Near Interchange Ramps on Principal Arterials.....	27
Stopping Sight Distance .....	28
Stopping Sight Distance .....	29
Intersection Sight Distances.....	30
Median Openings/Crossovers .....	32
Crossover Location Approval Process.....	32
Crossover Grades.....	33
Intersecting Cross Road Grades .....	34
Roundabouts.....	35
<b>SECTION 3 – TURNING LANES.....</b>	<b>36</b>
Left and Right Turn Lane Criteria .....	36
Warrants for Left Turn Storage Lanes on Four-Lane Highways .....	38
Warrants for Left-Turn Storage Lanes on Two-Lane Highways.....	39
Medians .....	50
Illustration of Directional Median Opening for Left Turns and U-Turns.....	52
Right Turn Lanes .....	53
Acceleration Lanes .....	57
<b>SECTION 4 – ENTRANCE DESIGN.....</b>	<b>63</b>
Entrance Design Principles .....	63
Private Entrances (Existing State Highways).....	64
Private Entrance Detail .....	64
Commercial Entrances .....	65
Commercial Entrance Location Criteria.....	68

<b>Commercial Entrance Sight Distance .....</b>	<b>70</b>
<b>Commercial Entrance Spacing .....</b>	<b>71</b>
<b>Corner Clearance Downstream on a Minor Side Street.....</b>	<b>71</b>
<b>Commercial Entrance Channelization Island Options.....</b>	<b>73</b>
<b>Entrance Connections on Opposite Sides of a Roadway .....</b>	<b>74</b>
<b>Entrance Consolidation (Shared Use Entrances) .....</b>	<b>75</b>
<b>Shared Entrances and Internal Site Interconnection.....</b>	<b>75</b>
<b>Frontage Roads.....</b>	<b>77</b>
<b>Limits of Maintenance Responsibility for Private and Commercial Entrances</b>	<b>78</b>
<b>Standard Private Subdivision Road / Street Entrance.....</b>	<b>79</b>
<b>Commercial Entrance Designs along Highways with Shoulders .....</b>	<b>80</b>
<b>Commercial Entrance Designs along Highways with Curb and Gutter .....</b>	<b>81</b>
<b>Commercial Entrance Designs along Highways with Shoulders at Intersection .....</b>	<b>82</b>
<b>Commercial Entrance Designs along Highways with Curb and Gutter at Intersection .....</b>	<b>83</b>
<b>Commercial Entrance Designs along Highways with Shoulders .....</b>	<b>84</b>

## List of Figures

Table 2-7 Intersection Sight Distance.....	30
Table 2-8 Intersection Sight distance Criteria .....	31
Figure 3-1 Left and Right Turn Lane Criteria .....	36
Figure 3-2 Left and Right Turn Storage and Taper Lengths.....	37
Figure 3-3 Warrants for Left Turn Storage Lanes on Four-Lane Highways .....	38
Table 3-1 Warrants For Left-Turn Lanes on Two-Lane Highways.....	39
Figure 3-22 Illustration of Directional Median Opening for Left Turns & U-Turns..	52
Figure 3-23 Guidelines For Right Turn Treatment (2-Lane Highway) .....	55
Figure 3-24 Guidelines For Right Turn Treatment (4-Lane Highway) .....	56
Figure 3-25 Typical Application with Sidewalks and Bike Lanes with Right-turn Deceleration Lanes (Curb and Gutter Section).....	58
Figure 3- 26 Typical Application of a Bus Pullout .....	59
Figure 3-27 Typical Application of a Right-turn Deceleration Lane (Shoulder Section) .....	60
Figure 3-28 Typical Application of a Left-turn Deceleration Lane (Shoulder Section).....	61
Figure 3- 29 Typical Application of a Right-turn Acceleration and Deceleration Lane(Shoulder Section).....	62
Table 4-1 Design Vehicle and Turning Radius by Land Use .....	63
Figure 4-1 Private Entrance Detail .....	65
Table 4-2 Entrance Throat Summary .....	66
Figure 4-2 Intersection Functional Area.....	68
Figure 4-2A Intersection Minimum Functional Length.....	69
Figure 4-3 Downstream Corner Clearance.....	72
Figure 4-4 Commercial Entrance Channelization Island Options .....	73
Figure 4-5 Entrance Connections On Opposite Sides Of A Roadway.....	74
Figure 4-6 Shared Entrances and Internal Site Interconnection .....	76
Figure 4-7 Limits of Maintenance Responsibility for Private and Commercial Entrances.....	78
Figure 4- 8 Standard Private Subdivision Road / Street Entrance .....	79
Figure 4- 9 Commercial Entrance Designs along Highways with Shoulders.....	80
Figure 4-10 Commercial Entrance Designs along Highways with Curb and Gutter .....	81
Figure 4-11 Commercial Entrance Designs along Highways with Shoulders at Intersection.....	82
Figure 4-12 Commercial Entrance Designs along Highways with Curb and Gutter at Intersection.....	83
Figure 4-13 Commercial Entrance Designs along Highways with Shoulders.....	84

## DEFINITIONS

**Acceleration Lane:** An auxiliary lane, including tapered areas, that enables a motorist to increase its speed to a rate that enables it to safely merge with through traffic.

**Access Management:** The systematic control of the location, spacing, design, and operation of entrances, median openings, traffic signals, and interchanges for the purpose of providing vehicular access to land development in a manner that preserves the safety and efficiency of the transportation system.

**Arterial:** A major highway intended to serve through traffic where access is carefully controlled, generally highways of regional importance, intended to serve moderate to high volumes of traffic traveling relatively long distances and at higher speeds.

**Auxiliary Lane:** The portion of the roadway adjoining the traveled way for speed change, turning, storage for turning, weaving, truck climbing, and other purposes supplementary to through-traffic movement.

**Channelization:** The separation or regulation of conflicting traffic movements into definite paths of travel by traffic islands or pavement marking to facilitate safe and orderly movements of vehicles, pedestrians and bicyclists.

**Collector:** Highway intended to move traffic from local roads to arterials supplying a combination of through movement and access to property.

**Commercial Entrance:** Any entrance serving land uses other than two or fewer individual private residences. (See "private entrance.")

**Conflict:** A traffic conflict occurs when the paths of vehicles intersect, an event that causes a driver to take evasive action to avoid collision with another vehicle, usually designated by a braking application or evasive lane change.

**Conflict Point:** An area where intersecting traffic either merges, diverges or crosses. Each conflict point is a potential collision.

**Corner Clearance:** The distance between an entrance and the nearest cross road intersection and is aimed at preventing the location of entrances within the functional area of an intersection.

**Crossover:** *See median opening.*

**Curb Cut:** An opening along the curb line where vehicles may enter or leave the highway.

**Deceleration Lane:** A speed-change lane including tapered areas that enables a turning vehicle to exit a through lane and slow to a safe speed to complete its turn.

**Design Speed:** The selected speed used to determine the geometric design features of the highway.

**Directional Median Opening:** An opening in a restrictive median that provides for specific movements and physically restricts other movements.

**Divided Highway:** A highway on which traffic traveling in opposite directions is physically separated by a median.

**Entrance:** Any driveway, street or other means of providing for the movement of vehicles to or from the state highway system.

**Entrance Throat:** The distance parallel to the centerline of an entrance to the first on-site location at which a driver can make a right turn or a left turn, measured on highways with curb and gutter, from the face of the curb, and on highways without a curb and gutter, from the edge of the shoulder.

**Entrance Width:** The distance edge-to-edge of an entrance measured at the right-of-way line.

**Egress:** The exit of vehicular traffic from a property to a highway.

**Exception:** Permission to depart from design standards because of the unique circumstances of the site or project.

**Frontage Road:** A road that generally runs parallel to a highway between the highway right-of-way and the front building setback line of the abutting properties and provides access to the abutting properties for the purpose of reducing the number of entrances to the highway and removing the abutting property traffic from through traffic on the highway.

**Full Access Entrance:** Entrance which allows left-in and left-out movements and right-in and right-out movements.

**Functional Area of an Intersection:** The area beyond the physical intersection that comprises decision and maneuver distance, plus any required vehicle storage length, and is protected through corner clearance standards and connection spacing standards.

**Functional Classification:** The federal system of classifying groups of highways according to the character of service they are intended to provide and classifications made by the Commissioner based on the operational characteristics of a highway. Each highway is assigned a functional classification based on the highway's intended purpose of providing priority to through traffic movement or adjoining property access. The functional classification system groups highways into three basic categories identified as (1) arterial, with the function to provide through movement of traffic; (2)

collector, with the function of supplying a combination of through movement and access to property; and (3) local, with the function of providing access to property.

**Grade Separation:** A crossing of two highways or a highway and a railroad, or a highway and a pedestrian walkway, at different elevations.

**Gradient or Grade:** The rate or percentage change in slope, measured along the centerline of the highway or entrance, either ascending or descending from or along the highway.

**Ingress:** The entrance of vehicular traffic into a property from a highway.

**Interchange:** A grade-separated system of access to and from highways that includes directional ramps for access to and from crossroads.

**Intersection:** Any at-grade connection with a highway including two highways or a commercial entrance and a highway.

**Intersection Sight Distance:** The sight distance required at an intersection to allow the driver of a stopped vehicle a sufficient view of the intersecting highway to decide when to enter, or cross, the intersecting highway.

**Legal Speed Limit:** The speed limit set forth on signs lawfully posted on a highway or in the absence of such signs the speed limit established by Title 46.2, Chapter 8, Article 8 of the Code of Virginia

**Limited Access Highway:** A highway especially designed for through traffic over which abutters have no easement or right of light, air, or access by reason of the fact that their property abuts upon the limited access highway.

**Local Road:** A roadway with the primary function of providing access to adjacent properties and to other roadways.

**Median:** That portion of a divided highway that separates opposing traffic flows, not including center two-way left-turn lanes, can be traversable or non-traversable.

**Median, Non-traversable (Restrictive Median):** A physical barrier in the highway that separates traffic traveling in opposite directions, such as a concrete barrier or landscaped island.

**Median Opening (Full):** An opening in a non-traversable median that provides for crossing and turning traffic.

**Median, Traversable (Nonrestrictive Median):** A median that by its design does not physically discourage or prevent vehicles from entering upon or crossing over it, including painted medians.



**Merge:** The process by which two separate traffic streams moving in the same direction combine or unite to form a single stream.

**Operating Speed:** The speed at which drivers are observed operating their vehicles during free-flow conditions with the 85<sup>th</sup> percentile of the distribution of observed speeds being the most frequently used measure of the operating speed of a particular location or geometric feature.

**Passing Sight Distance:** The length of roadway that the driver of the passing vehicle must be able to see initially, in order to make a passing maneuver safely.

**Partial Access Entrance:** Entrance with movements limited to right-in, right-out, and left-in movements.

**Peak Hour Volume:** The largest number of vehicles passing over a designated section of a street during the busiest 60-minute period within a 24-hour period.

**Phase (Signal):** That portion of a traffic signal cycle allocated to a specific traffic movement or combination of movements.

**Private Entrance:** An entrance that serves up to two private residences and is used for the exclusive benefit of the occupants or an entrance that allows agricultural operations to obtain access to fields or an entrance to civil and communication infrastructure facilities that generate 10 or fewer trips per day such as cell towers, pump stations, and stormwater management basins.

**Ramp Terminal:** That portion of a ramp adjacent to the through traveled way, including speed-change lanes, tapers, and islands. Ramp terminals may be the at-grade type, as at the crossroad terminal of diamond or partial cloverleaf interchanges, or the free-flow type where ramp traffic merges with or diverges from high-speed through traffic at flat angles.

**Right-of-way:** That property within the systems of state highways that is open or may be opened for public travel or use or both in the Commonwealth. This definition includes those public rights-of-way in which the Commonwealth has a prescriptive easement for maintenance and public travel. The property includes the traveled way and associated boundary lines and parking and recreation areas.

**Roadway:** The portion of a highway, including shoulders, for vehicular use. A divided highway has two or more roadways.

**Shared Entrance:** A single entrance to provide access to two or more adjoining parcels.

**Shoulder:** The portion of the highway that lies between the edge of the traveled way and the break point, excluding turn lanes.

**Sight Distance:** The distance visible to the driver of a vehicle when the view is unobstructed by traffic.

**Sight Triangle:** An area of unobstructed sight distance along both approaches of an entrance.

**Signal Progression:** The progressive movement of traffic, at a planned rate of speed without stopping, through adjacent signalized locations within a traffic control system.

**Signal Spacing:** The distance between traffic signals along a highway.

**Stopping Sight Distance:** The distance required by a driver of a vehicle, traveling at a given speed, to bring the vehicle to a stop after an object on the highway becomes visible, including the distance traveled during the driver's perception and reaction times and the vehicle braking distance.

**Storage Length:** Lane footage added to a deceleration lane to store the maximum number of vehicles likely to accumulate during a peak period, so as not to interfere with the through-travel lanes.

**Taper:** The widening of pavement to allow the redirection and transition of vehicles around or into a turn lane; of two types: (a) redirect tapers necessary for the redirection of vehicles along the traveled way; and (b) transition tapers for turn lanes that allow the turning vehicle to transition from or to the traveled way, to or from a turn lane.

**Through Movement:** The predominant direction of traffic flow through an intersection, straight on most major roads, although the predominant flow of traffic occasionally is in a right or left-turning direction.

**Traveled Way:** The portion of the highway provided for the movement of vehicles, exclusive of shoulders and turn lanes.

**Turn Lane:** A separate lane for the purpose of enabling a vehicle that is entering or leaving a highway to increase or decrease its speed to a rate at which it can more safely merge or diverge with through traffic; acceleration and deceleration lanes.

**VPH (Vehicles per Hour):** The number of vehicles per hour, usually referring to vehicles in a peak hour.

**Warrant:** The criteria by which the need for a safety treatment or highway improvement can be determined.

**Weaving:** The crossing of two or more traffic streams traveling in the same general direction along a significant length of highway, without the aid of traffic control devices. Weaving areas are formed when a merge area is closely followed by a diverge area, or when an entrance ramp is closely followed by an exit ramp and the two ramps are joined by a auxiliary lane.

## **SECTION 1- INTRODUCTION**

### **Access Management Concepts**

Access management provides a systematic approach to balancing the access and mobility necessities of a roadway. Access management can be defined as the process of managing access to land development, while simultaneously preserving the flow of traffic on the surrounding public road system.

Property owners have a right to reasonable access to the general system of streets and highways. In conjunction, adjacent roadway users have the right to freedom of movement, safety, and efficient expenditure of public funds. Balancing these interests is critical at locations where significant changes to the transportation system and/or surrounding land uses are occurring. The safe and efficient operation of the transportation system calls for effectively managing highway access, via entrances, streets, or other access points.

The specific techniques for managing access involve the application of established traffic engineering and planning principles. Ideally, these principles will:

- Limit the number of traffic conflicts;
- Separate basic conflict areas;
- Separate turning volumes from through movements;
- Provide sufficient spacing between at-grade intersections;
- Maintain progressive speeds along arterials;
- Provide adequate on-site storage lanes.

The application of these principles will minimize disruptions to through traffic caused by entrances and intersections. More specifically, good access management can:

- Reduce crashes and crash potential;
- Preserve roadway capacity and the useful life of roads;
- Decrease travel time and congestion;
- Improve access to properties;
- Coordinate land use and transportation decisions;
- Improve air quality;
- Maintain travel efficiency and related economic prosperity.

## Functional Classification

The Federal Highway Administration's (FHWA) "Functional Classification Guidelines" state that Functional Classification is the process by which streets and highways are grouped into classes, or systems, according to the character of service they are intended to provide.

Basic to this process is the recognition that individual roads and streets do not serve travel independently in any major way. Rather, most travel involves movement through a network of roads. It becomes necessary then to determine how this travel can be channelized within the network in a logical and efficient manner.

Functional classification defines the nature of this channelization process by defining the part that any particular road or street should play in serving the flow of trips through a highway network. A schematic illustration of a functionally classified roadway network is presented below.

Since cities and larger towns generate and attract a large proportion of the relatively longer trips, the arterial highways generally provide direct service for such travel. In Rural areas the intermediate functional category, the collectors, serves small towns directly, connects them to the arterial network, and collects traffic from the bottom-level system of local roads, which serves individual farms and other rural land uses.

The same basic concepts apply in urban areas as well. A similar hierarchy of systems can be defined; however, because of the high intensity of land use and travel throughout an urban area, specific travel generation centers are more difficult to identify. In urban areas additional considerations, such as spacing, become more important in defining a logical and efficient network.

Allied to the idea of traffic channelization is the dual role the highway network plays in providing (1) access to property, and (2) travel mobility. Access is a fixed requirement, necessary at both ends of any trip. Mobility, along the path of such trips, can be provided at varying levels, usually referred to as "level of service." It can incorporate a wide range of elements (e.g., riding comfort and freedom from speed changes) but the most basic is operating speed or trip travel time.

## Schematic of a Functionally Classified Roadway Network

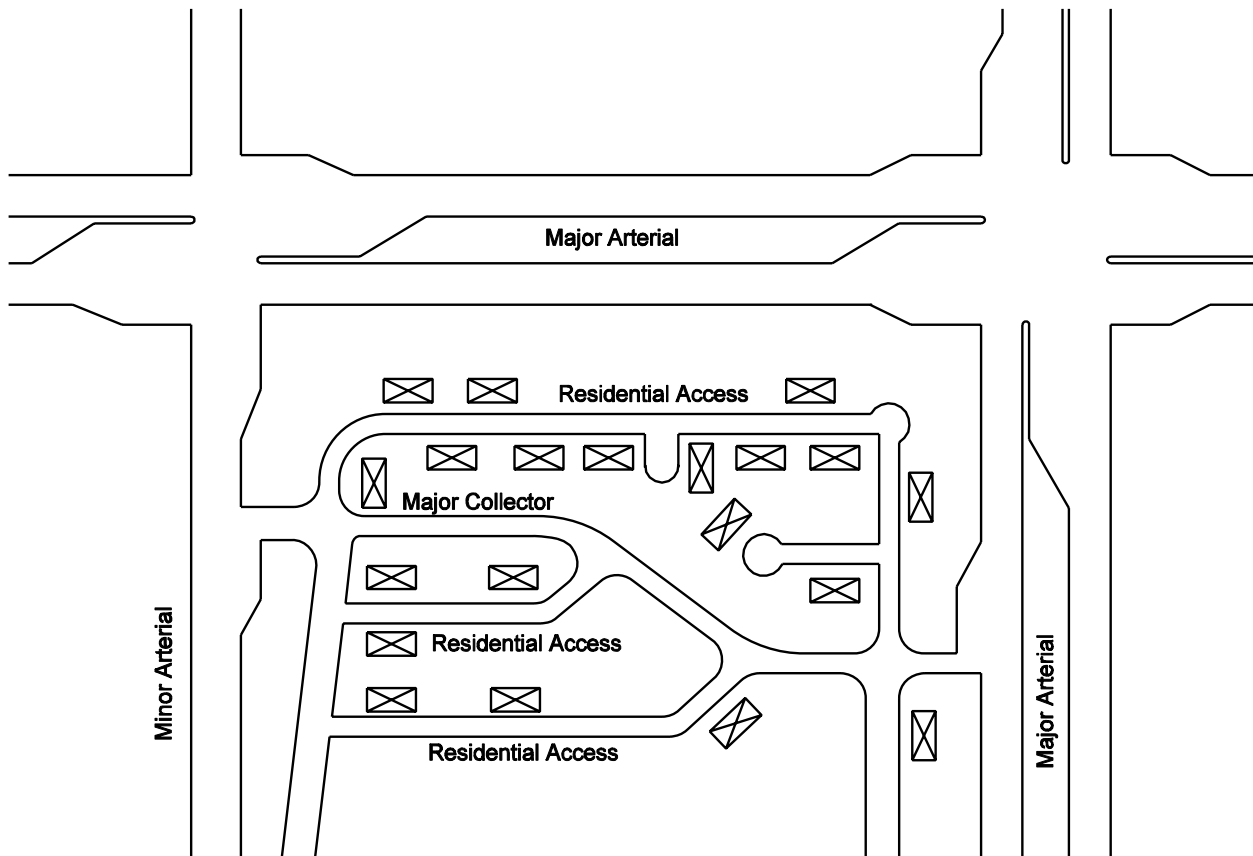

**FIGURE 1-1**

Source: Transportation Research Board, Access Management Manual, 2003

## Relationship of Functionally Classified Systems in Serving Traffic Mobility and Land Access

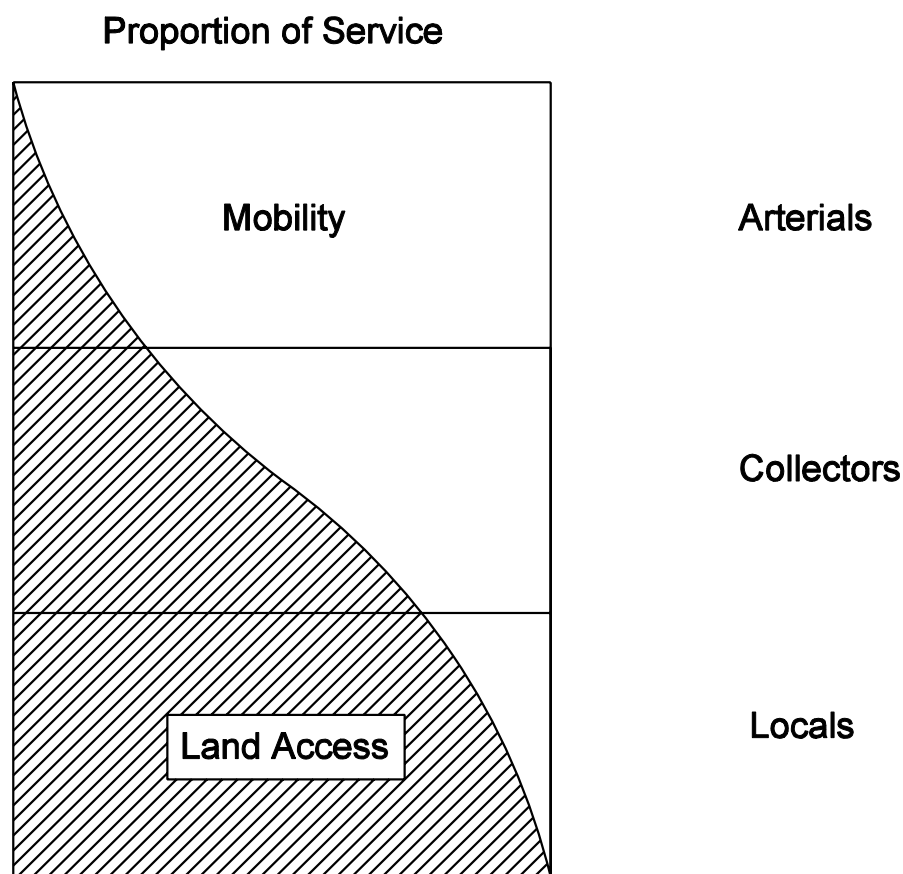

Source: 2004 AASHTO Green Book

It was pointed out in the discussion above that the concept of traffic channelization leads logically not only to a functional hierarchy of systems, but also to a parallel hierarchy of relative travel distances served by those systems. This hierarchy of travel distances can be related logically to a desirable functional specialization in meeting the access and mobility requirements. Local facilities emphasize the land access function. Arterials emphasize a high level of mobility for through movement. Collectors offer a compromise between both functions. This is illustrated conceptually above.

Functional classification can be applied in planning highway system development, determining the jurisdictional responsibility for particular systems, and in fiscal planning. These applications of functional classification are discussed in "A Guide for Functional Highway Classification."

## **Urban and Rural Area Definitions**

Urban and rural areas have fundamentally different characteristics as to density and types of land use, density of street and highway networks, nature of travel patterns, and the way in which all these elements are related in the definitions of highway function.

Experience has shown that extensions of rural arterial and collector routes provide an adequate arterial street network in places of less than 5,000 population. Hence urban classifications as discussed herein are considered in the context of places of 5,000 population or more.

Urban areas are defined in Federal-aid highway law (Section 101 of Title 23, U.S. Code) as follows:

"The term 'urban area' means an urbanized area or, in the case of an urbanized area encompassing more than one State, that part of the urbanized area in each such State, or an urban place as designated by the Bureau of the Census having a population of five thousand or more and not within any urbanized area, within boundaries to be fixed by responsible State and local officials in cooperation with each other, subject to approval by the Secretary. Such boundaries shall, as a minimum, encompass the entire urban place designated by the Bureau of the Census."

"Urban area" includes urbanized areas (population of 50,000 and over and urban places (population of 5,000 or more and not located within an urbanized area). For clarity and simplicity, the FHWA uses the term "small urban area" as a substitute for "urban place".

Rural areas comprise the areas outside the boundaries of small urban areas and urbanized areas.

## Functional System Characteristics

### The Hierarchy of Functional Classifications

RURAL AREAS	URBANIZED AREAS	SMALL URBAN AREAS
Principal arterials Minor arterial roads Collector roads Local roads	Principal arterials Minor arterial streets Collector streets Local streets	Principal arterials Minor arterial streets Collector streets Local streets

Roadway design practices are inextricably linked to the purpose of the road as defined by the functional classification system as follows:

Classification	Location	Characteristics
<b>Principal Arterial</b>	<b>Rural</b>	Trip lengths for statewide or interstate travel. Integrated movement generally without stub connections. Accommodates movement between (virtually) all areas with pop. 50,000. Two design types: freeways and other principal arterials.
	<b>Urban</b>	Serves major centers of activity with the highest traffic volumes and longest trip lengths. Integrated internally and between major rural connections. Service to abutting lands is subordinate to travel service to major traffic movements. Design types are interstate, other freeways and other principal arterials.
<b>Minor Arterial</b>	<b>Rural</b>	Links cities, large towns and other traffic generators attracting traffic over long distances. Intercounty service. Designs should be expected to provide for relatively high speeds and minimum interference to through movements.
	<b>Urban</b>	Trips of moderate length at a lower level of mobility than principal arterials. Some emphasis on land access. May carry local bus routes and provide intracommunity continuity but does not penetrate neighborhoods.
<b>Collector</b>	<b>Rural</b>	Serve intracounty travel with travel distances shorter than on arterial system. More moderate speeds. Divided into major and minor system.
	<b>Urban</b>	Provides both land access and traffic circulation within all areas. Penetrates neighborhoods and communities collecting and distributing traffic between neighborhoods and the arterial streets.
<b>Local</b>	<b>Rural</b>	Local roads primarily provide access to adjacent land and the collector network. Travel is over short distances.
	<b>Urban</b>	Primarily permits direct land access and connections to other streets. Lowest level of mobility. Long distance through traffic is usually discouraged.

**FIGURE 1-2**

Source: Transportation Research Board (TRB) Circular E-C019, Dated December, 2000



## **SECTION 2 – INTERSECTION DESIGN; SPACING STANDARDS**

### **Intersection Design Objectives**

Intersection design, including entrances, must consider the following items:

- Total approach traffic, design hourly volumes, and turning volumes.
- Composition of traffic (percent of passenger cars, buses, trucks, etc.)
- Operating speed of vehicles
- Functional Classification of Highways
- Adjacent land use
- Physical and Environmental Characteristics
- Pedestrian and Bicycle Accommodation

Major objectives of traffic design concern safety, operational efficiency and driver expectation through consideration of the following:

- The design should fit the natural transitional paths and operating characteristics of drivers and vehicles. Smooth transitions should be provided for changes in direction.
- Grades at intersections should be as nearly level as possible.
- Sight distances must be sufficient to enable drivers to prepare for and avoid potential conflicts.
- On major roadways, intersections must be evenly spaced to enhance the synchronization of signals, increase driver comfort, improve traffic operation, and reduce fuel consumption and vehicle emissions.

### Intersection Design Principles

- | Intersection Design Principles  |
|---|
| <ul style="list-style-type: none"><li>• Limit Number of Conflict Points</li><li>• Coordinate Design and Traffic Control</li><li>• Avoid Complex Maneuvers</li><li>• Separate Conflict Points</li><li>• Favor Major Flows</li><li>• Segregate Movements</li><li>• Accommodate Pedestrians and Bicyclists</li><li>• Consider the Design Vehicle</li><li>• Consider a roundabout</li></ul> |

Intersection design principles are as follows:

- Limit the number of conflict points. The number of conflict points among vehicular movements increases significantly as the number of intersection legs increase. For example, an intersection with four two-way legs has 32 total conflict points, but an intersection with six two-way legs has 172 conflict points. Intersections with more than four two-way legs should be avoided wherever possible.

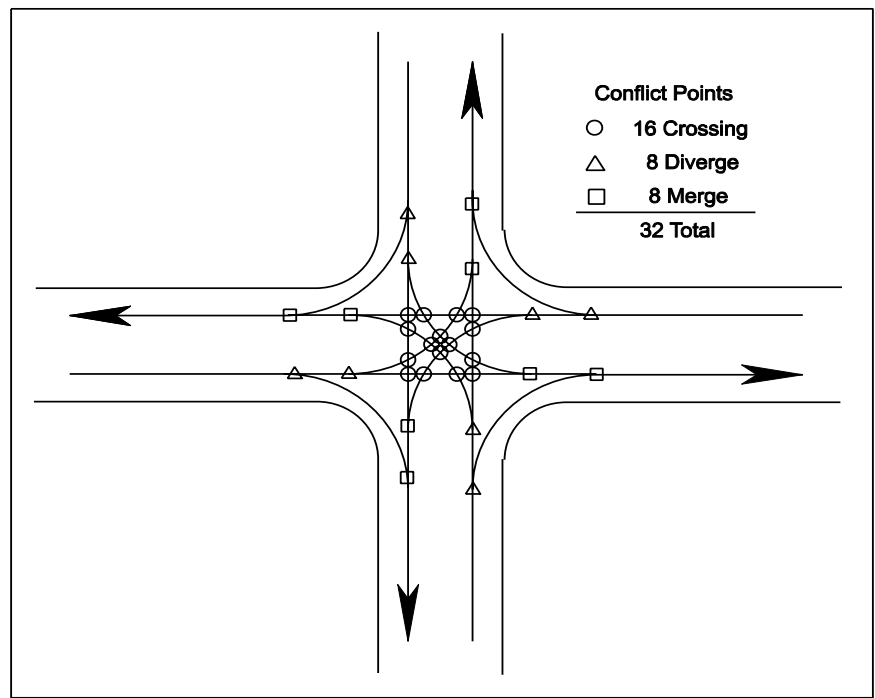
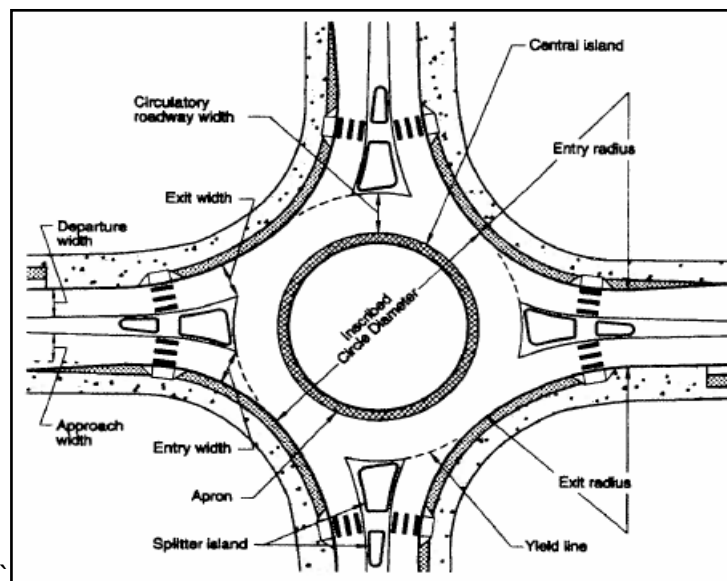

**FIGURE 2-1 CONFLICT POINTS**

Source: Transportation Research Board, Access Management Manual

- Coordinate design and traffic control. Maneuvers at intersections accomplished at low relative speeds require a minimum of traffic control devices. Maneuvers accomplished at high relative speeds are undesirable unless traffic controls such as stop signs or traffic signals are provided. Designs should separate vehicles making conflicting movements. Intersection design should be accomplished simultaneously with the development of traffic control plans.
- Avoid multiple and compound merging or diverging movements. These require complex driver decisions and create additional conflicts.
- Separate conflict points. Intersection hazards and delays are increased when intersection maneuver areas are too close together or when they overlap. Conflicts should be separated to provide drivers with sufficient time (and distance) between successive maneuvers for them to cope with the traffic conflicts one at a time.
- Favor the heaviest and fastest flows. The heaviest volume and higher speed flows should be given preference in intersection design to minimize hazard and delay.
- Minimize the area of the conflict. Excessive intersection area causes driver confusion and inefficient operations. Large areas are inherent with long curb return radii and in skewed and multiple-approach intersections. Channelization should be employed to limit the intersection and to guide drivers.
- Segregate movements. Separate lanes should be provided at intersections when there are appreciable volumes of traffic traveling at different speeds. Separate turning lanes should be provided for left and right turning vehicles. Left turns necessitate direct crossings of opposing vehicle paths and are usually made at speeds of 10 mph or less for reasons of safety and economy. Right turns are also usually made at minimum speeds. However, right turns do not involve potential conflicts of such severity as left turns, and are more suited to individual treatment because they take place at the outside of the intersection area. Therefore, right turns may be designed for higher than minimum speeds where adequate right of way is available for wider turns.
- Accommodate the needs of pedestrians and bicyclists. For example, when pedestrians must cross wide streets, refuge islands are important for pedestrian safety. See Figure 3-26 for illustration.
- Consider the design vehicle. The shapes and dimensions of turning paths vary for different turning speeds, different angles of turn, and different types and sizes of vehicles. The design vehicle must be identified and turning templates properly applied. See Table 4-1 for Design Vehicle Chart.

- Consider a roundabout design. Roundabouts offer an attractive design alternative to conventional intersections. Roundabouts are circular intersections with specific design and traffic control features that convert all vehicular movements to right turns and force traffic to enter and circulate at lower, more consistent speeds. The safety benefits of low vehicle speeds include less severe and less frequent crashes. See page 35 for additional information on the use of roundabouts.



**FIGURE 2-1A ROUNDABOUT BASIC GEOMETRIC DESIGN ELEMENTS**

Source: Federal Highway Administration, Roundabouts: An Informational Guide, 2000.

At-grade intersections must provide adequately for anticipated turning and crossing movements. AASHTO's A Policy on Geometric Design of Highways and Streets, "Intersections" should be reviewed for additional information to be considered in the design since the site conditions, alignment and grade, sight distance, the need for turning lanes and other factors enter into the type of intersection design which would satisfy the design hour volume of traffic, the character or composition of traffic, and the design speed. A Highway Capacity Manual (HCM) capacity or other appropriate analysis (Corsim/Synchro) should be performed for intersection capacity and signalization requirements, and include a queuing analysis.

Sufficient offset dimensions, pavement widths, pluses, and radii shall be shown in the plans by the designer to insure that sign islands are properly positioned. Care should be taken in the design of four-lane roadways with intersecting two-lane roadways. If traffic conditions clearly warrant a four-lane divided design for the two-lane road at the intersection, the divided design must be constructed for a sufficient distance to allow for the approaching divided design and the subsequent stop condition ahead to be properly signed. The four-lane divided design should not be constructed unless it is clearly warranted and the approaches can be properly signed or the minor road is expected to be improved to a divided status in the near future.

- Following are examples of typical geometric design applications:

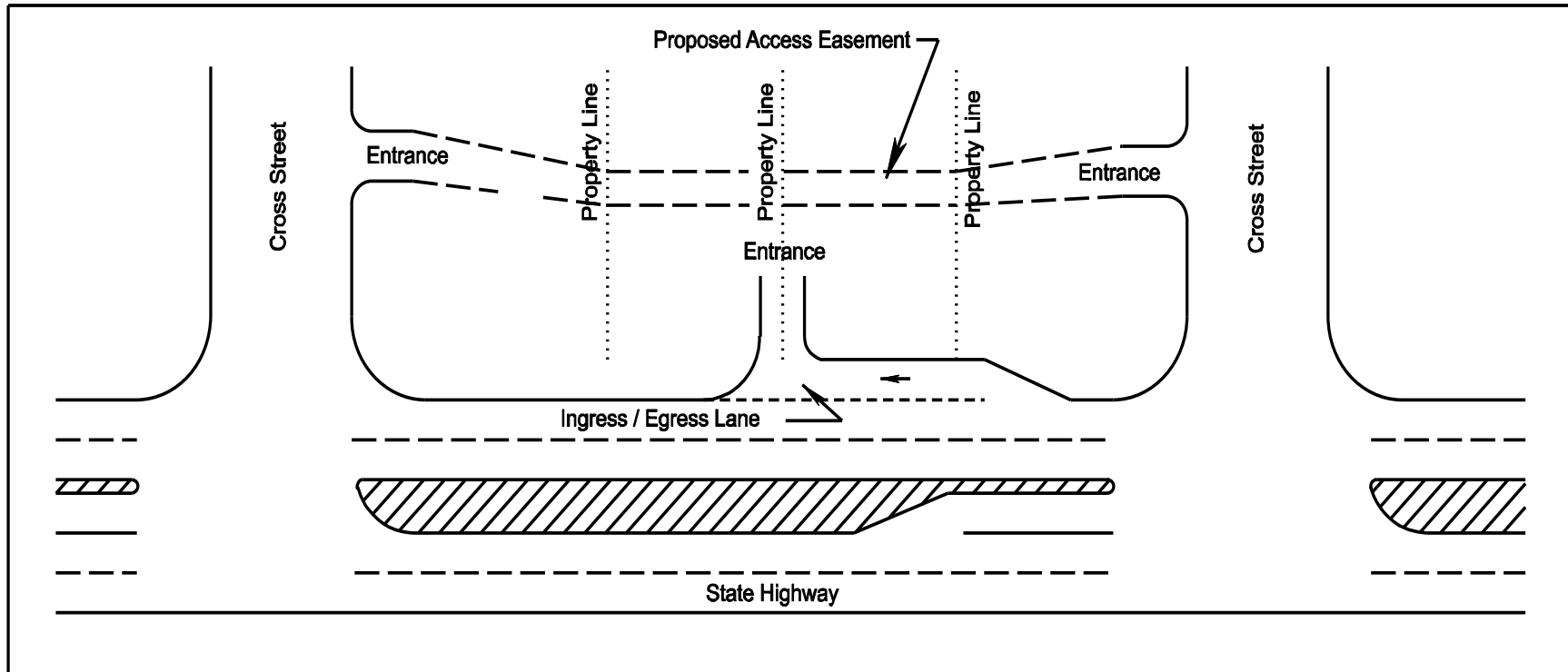

**FIGURE 2-2 INGRESS / EGRESS LANE ILLUSTRATION**

Reg. 24Vac 30-72-120.4

Note: All entrance design and construction shall accommodate pedestrian and bicycle users of the highway in accordance with the Commonwealth Transportation Board's "Policy for Integrating Bicycle and Pedestrian Accommodations".

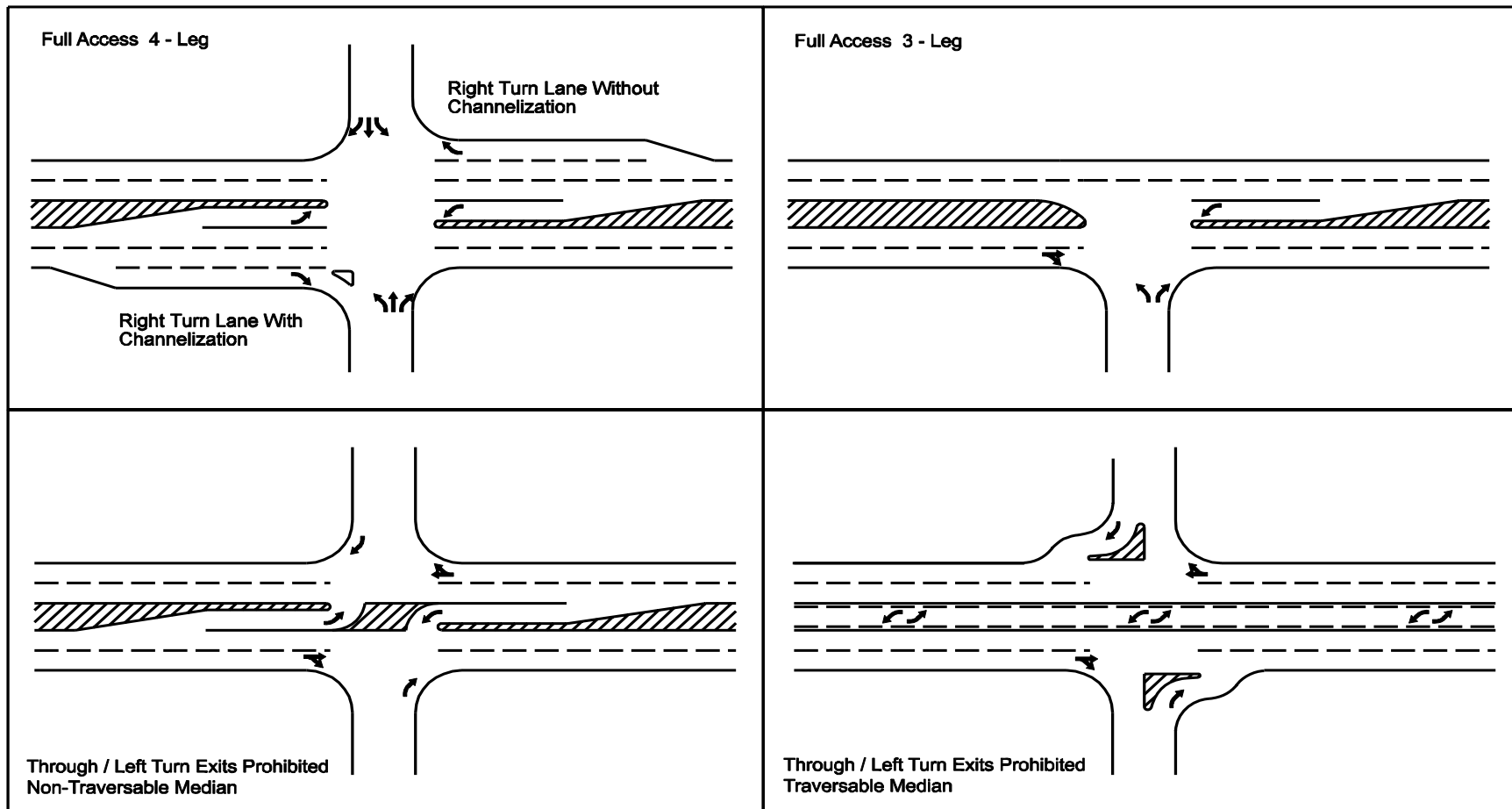

**FIGURE 2-3 TYPES OF ACCESS CHANNELIZATION**

Note: All entrance design and construction shall accommodate pedestrian and bicycle users of the highway in accordance with the Commonwealth Transportation Board's "Policy for Integrating Bicycle and Pedestrian Accommodations".

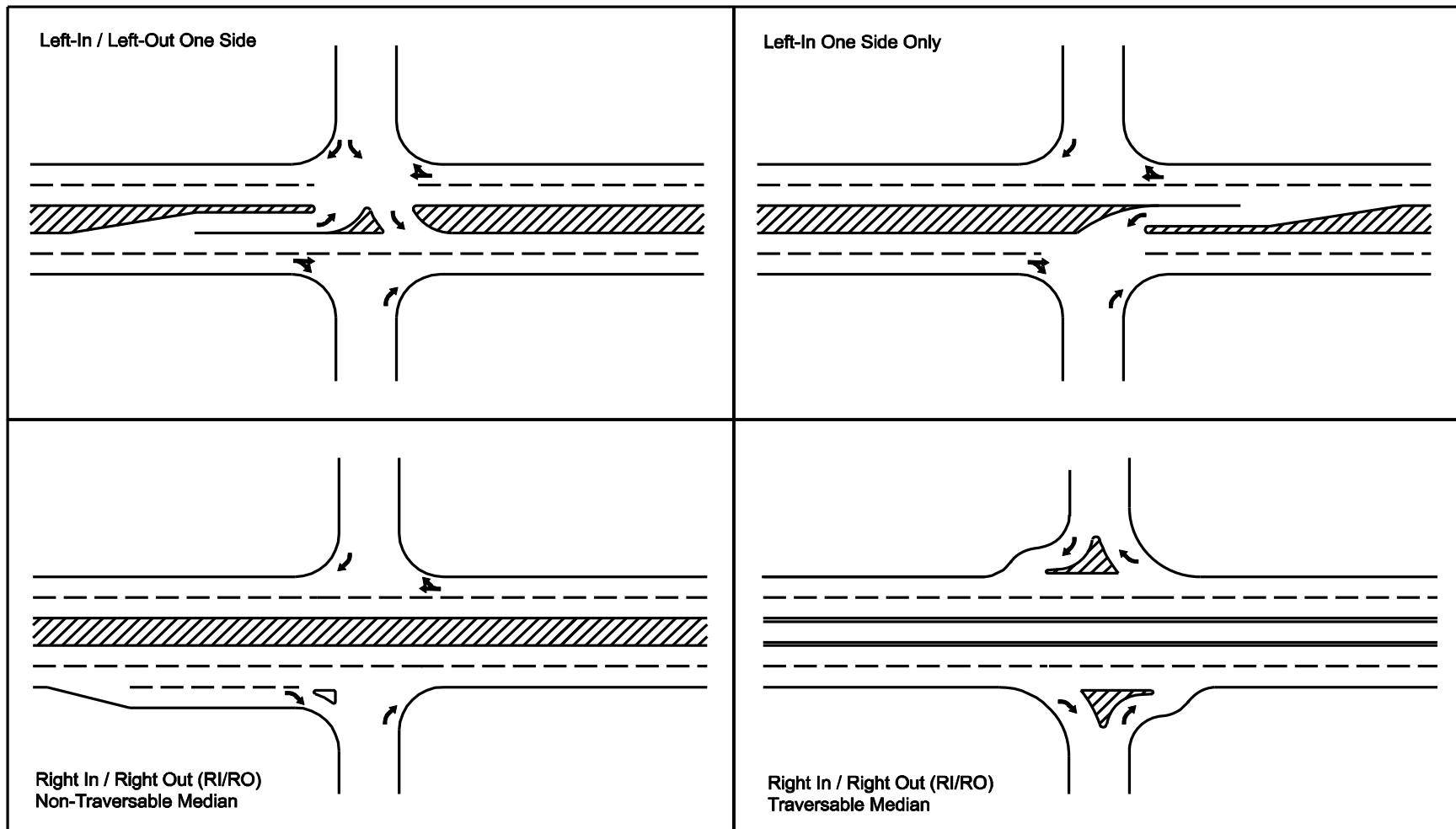

**FIGURE 2-4 TYPES OF ACCESS CHANNELIZATION**

Note: All entrance design and construction shall accommodate pedestrian and bicycle users of the highway in accordance with the Commonwealth Transportation Board's "Policy for Integrating Bicycle and Pedestrian Accommodations".

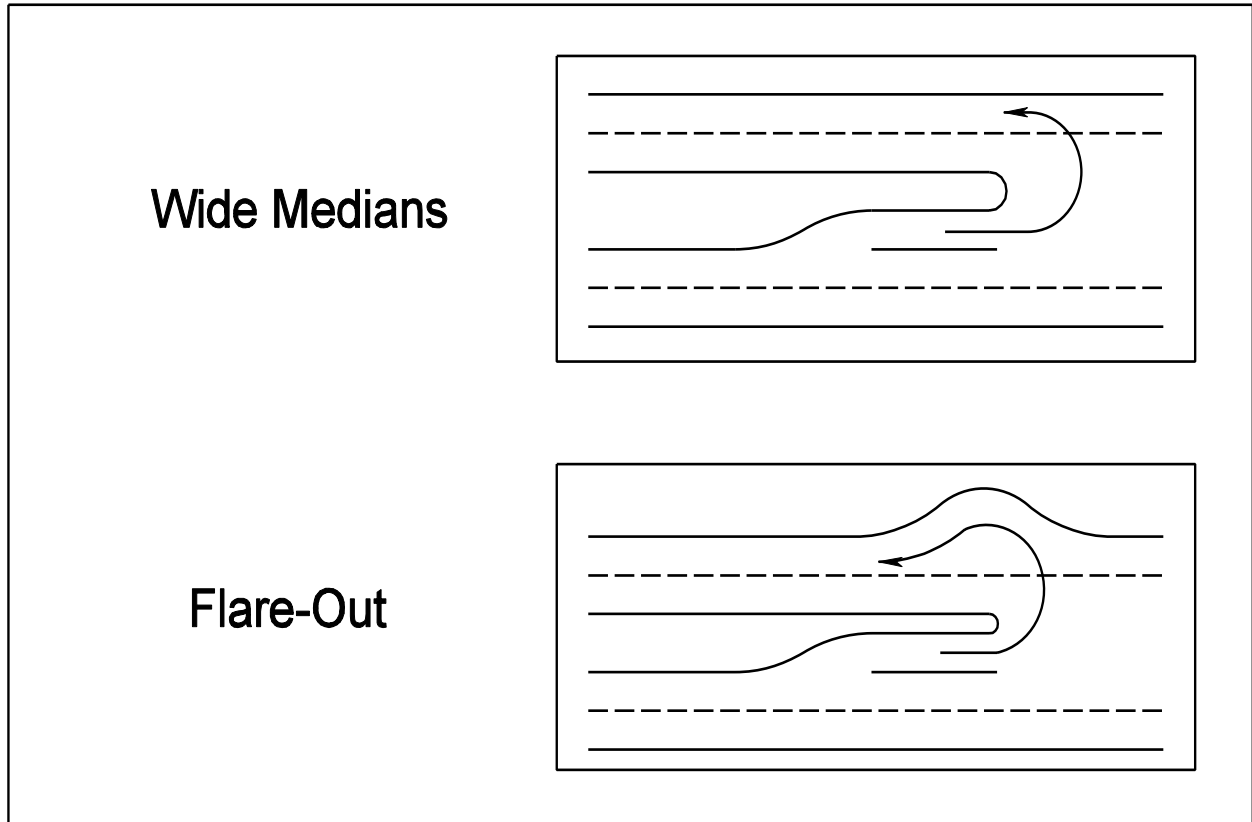

**FIGURE 2-5 U-TURN DESIGN OPTIONS**

Note: These examples are not all-inclusive. Other options may be developed, which would require VDOT approval.



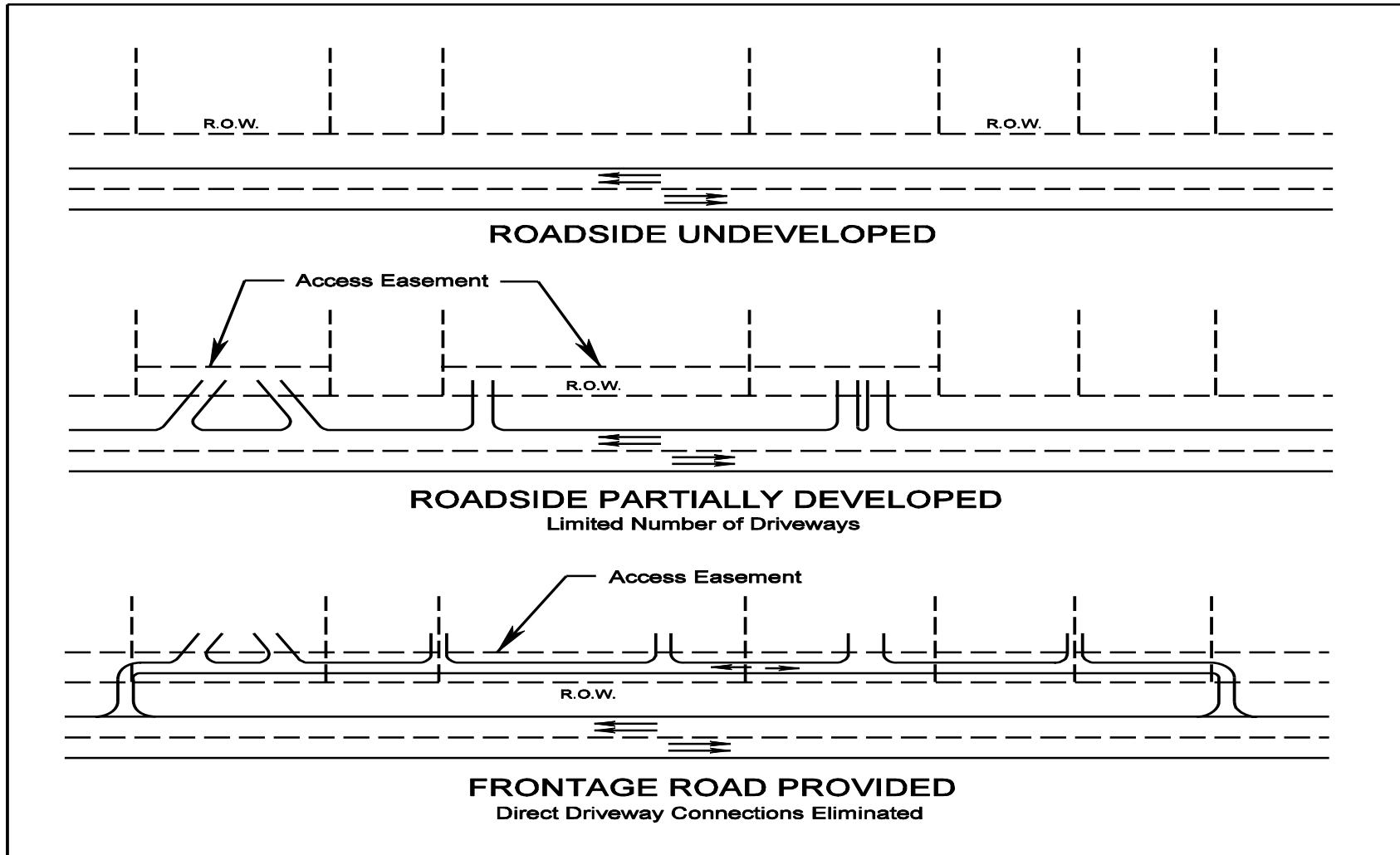
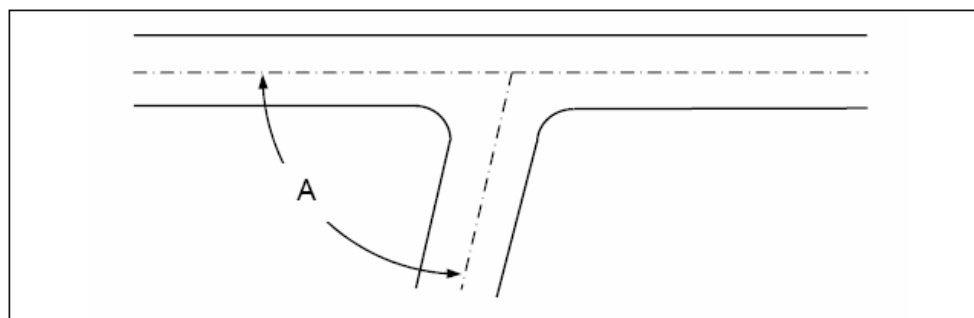

**FIGURE 2-6 ACCESS DEVELOPMENT SCENARIO ALONG A STATE HIGHWAY**

Note: All entrance design and construction shall accommodate pedestrian and bicycle users of the highway in accordance with the Commonwealth Transportation Board's "Policy for Integrating Bicycle and Pedestrian Accommodations".

### Minimum Angle of Intersections

Streets should intersect at right angles; however, intersecting angles between 60 and 90 degrees are allowed.



Source: AASHTO "Green Book"

A = Minimum 60 degrees

**FIGURE 2-7**

### Signalized Intersection Spacing

One of the variables involved in the planning, design and operation of signalized arterial streets is "Signalized Intersection Spacing" (See Table 2-2). Efficient traffic progression is essential on major suburban/urban roadways in order to maximize safety and capacity. Moreover, at high progression efficiencies, fewer vehicles are required to come to a stop. Deceleration noise is reduced: thus, vehicle emissions, fuel consumption and delay are minimized. Since capacity will always be an issue on a major urban arterial once urban development has occurred, the signal spacing must be such that very high progression efficiencies can be obtained over a wide range of through and turn volumes which change over time and which differ by time of day.

Selecting long and uniform signalized intersection spacing is an essential element in establishing spacing standards. Several studies have found that the number of crashes and crash rates increases with the frequency of traffic signals. For example an increase in signal density from 2.0 or less to 2.1 to 4.0 signals per mile can result in a 70% increase in the average crash rate – from about 2.8 to 4.8 crashes per million vehicle miles. The increased number of signals per mile also results in poor fuel efficiency and excessive vehicle emissions.

(Source: TRB Access Management Manual. 2003)

<b>Signalized Intersection Spacing</b>	
<ul style="list-style-type: none"> <li>• Essential to Movement Function</li> <li>• Parameters               <ul style="list-style-type: none"> <li>- Speed</li> <li>- Cycle Length (“Green” Band desired)</li> <li>- Signal Spacing</li> <li>- Efficiency of Progression</li> <li>- Vehicle Mix</li> <li>- Grade</li> <li>- Queuing</li> <li>- Emergency Preemptions</li> </ul> </li> </ul>	

Source: NHI Course No. 15255, additions made by Committee.

Major arterials are intended to provide a high degree of mobility and serve the longer trips. Since movement, not access, is the principal function, access management is essential in order to preserve capacity and safety. [AASHTO’s “A Policy on the Geometric Design of Highways and Streets” (Green Book)]. Further, the adoption of functional design, in lieu of volume based design, represents a major change in the philosophy of planning and design of street and highway systems.

A uniform signal spacing of ½ mile provides for efficient signal progression at speeds of 30 mph to 60 mph along major suburban arterials. At these speeds maximum flow rates are achieved and fuel consumption and emissions are kept to a minimum.

Generally a ½ -mile spacing will enable traffic flow at a wide range of speeds with cycle lengths ranging from 60 to 120 seconds. A ½-mile spacing is needed to provide efficient progressions at 30 mph with a 120-second cycle commonly used in developed urban areas during peak hours. At slower speeds the increase in headway will result in a serious reduction in flow rate. (Source: TRB Access Management Manual. 2003)

Cycle Length (s)	Spacing			
	1/8 mi (600 ft)	1/4 mi (1,320 ft)	1/3 mi (1,760 ft)	1/2 mi (2,640 ft)
	Progression Speed (mph)			
60	15	30	40	60
70	13	26	34	51
80	11	22	30	45
90	10	20	27	40
100	9	18	24	36
110	8	16	22	33
120	7.5	15	20	30

**TABLE 2-1 SIGNALIZED INTERSECTION SPACING**

Relationship between speed, cycle length, and signal spacing.

Source: TRB: Access Management Manual, 2003

### ILLUSTRATION OF ENTRANCE AND INTERSECTION SPACING

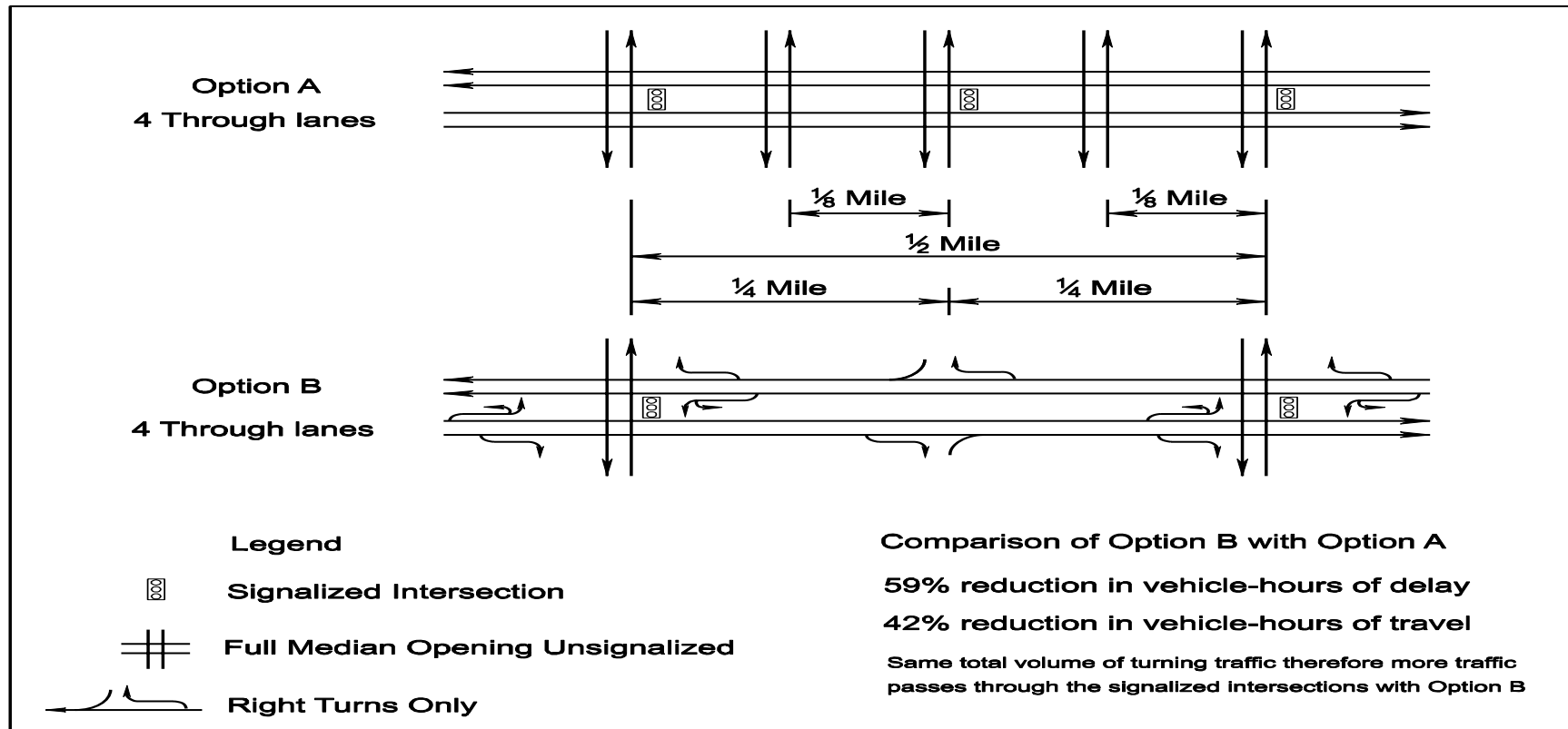

Source: TRB, Access Management Manual, Dated 2003

**FIGURE 2-8 ILLUSTRATION OF ENTRANCE AND INTERSECTION SPACING**

**1/2-mile signal spacing and access control result in substantial savings in delay and travel time compared with 1/4-mile signal spacing.**

Note: Four-lane roadway with 1/2-mile signalized intersection spacing can carry the same volume as six lanes with 1/4-mile signal spacing.

## **Unsignalized Intersection Spacing**

The key factor for determining unsignalized spacing is stopping sight distance. Other criteria that may be considered include the following:

1. Functional classification
2. Speed limit
3. Safety
4. Intersection sight distance.
5. Functional area of intersection
6. Right-turn conflict overlap
7. Vehicle Type
8. Egress capacity

See Table 2-2 for Unsignalized Intersection Spacing.

<b>Spacing Standards for Commercial Entrances, Intersections, and Crossovers</b>				
<b>Highway Functional Classification</b>	<b>Legal Speed Limit (mph)<sup>①</sup></b>	<b>Centerline to Centerline Spacing in Feet</b>		
		<b>Signalized Intersections<sup>②</sup></b>	<b>Unsignalized Intersections &amp; Full Access Entrances<sup>③</sup></b>	<b>Partial Access One or Two Way Entrance<sup>④</sup></b>
<b>Urban <sup>⑤</sup> Principal Arterial</b>	≤ 30 mph	1,760	1,050	270
	35 to 45 mph	2,640	1,320	325
	≥ 50 mph	2,640	1,320	510
<b>Rural <sup>⑥</sup> Principal Arterial</b>	≤ 30 mph	2,640	1,320	270
	35 to 45 mph	2,640	1,320	440
	≥ 50 mph	2,640	1,760	585

**TABLE 2-2 SPACING STANDARDS FOR COMMERCIAL ENTRANCES, INTERSECTIONS, AND CROSSOVERS**

- Notes: A. Spacing distances in the columns for signalized intersections and unsignalized intersections & full access entrances also apply to crossovers on divided highways.
- B. For all commercial entrances, intersections and crossovers, the appropriate intersection sight distance from Table 2-7 must be met; however the intersection sight distance does not control the access spacing shown above.
- C. See Appendix C for crossover spacing standards for all other functionally classified highways.

- ① **Legal Speed Limit** – Use legal speed limit unless the design speed is available and approved for use by VDOT.
- ② **Signalized Intersection Spacing** – Allocated in fractions of a mile: (1/2 mile, 2,640 ft); (1/3 mile, 1,760 ft); (1/4 mile, 1,320 ft); (1/5 mile, 1,050 ft). Based on *Transportation and Land Development* by Vergil Stover and Frank Koepke, Institute of Transportation Engineers, pages 4-23 to 4-32 and Figure 4-16 *Relationship Between Progression Speed, Cycle Length, and Signal Spacing*. Page 4-23: “Traffic signal control applied in a sequential pattern according to specific spacing criteria optimize traffic efficiency” ...”to reduce fuel consumption, reduce delay, reduce vehicular emissions and improve safety.”
- ③ **Unsignalized Intersections and Full Access Entrances** – These operate in a similar manner such that spacing standards can apply to both equally. Because some intersections and entrances can eventually become signalized, spacing should relate to signalized intersection spacing. Therefore, the spacing standards are generally one half of those for signalized intersections.

- ④ **Partial Access One or Two Way Entrances** – Left turn movements are limited. Spacing for this type of entrance, e.g. right in/right out with/without left in movement, on arterials is based on the length of a right auxiliary turn lane (entering taper, deceleration length, storage length) needed for a safe deceleration from the full design speed of the highway for turning into an entrance. A Policy on Geometric Design of Highways and Streets 2004, AASHTO, pages 713 to 716. Calculations: (30 mph, 270 ft); (35 mph, 325 ft); (40 mph, 375 ft); (45 mph, 440 ft); (50 mph, 510 ft); (55 mph, 585 ft).
- ⑤ **Urban Principal Arterials** – “Urban” is an abbreviation of “urban area” as defined in the Introduction to this document. On older, established business corridors of a locality where existing entrances and intersections did not meet the above spacing standards prior to the effective date of the Access Management Regulations (24 VAC 30-72) for highways with a functional classification as an urban principal arterial, spacing for new entrances and intersections may be allowed by the District Administrator or designee that is consistent with the established spacing along the highway, provided that reasonable efforts are made to comply with the access management requirements in 24 VAC 30-72-120 of the Access Management Regulations including restricting entrances within the functional areas of intersections, sharing entrances with and providing vehicular and pedestrian connections between adjacent properties, and physically restricting entrances to right-in or right-out or both movements.
- ⑥ **Rural Principal Arterials** – “Rural” is an abbreviation for “rural area” as defined in the Introduction to this document. Rural Unsignalized Intersection/Full Access Entrance spacing standards are one fraction of a mile greater than their urban counterparts (1/4 vs. 1/8 mile). Partial Access Entrance spacing standards are based on the right auxiliary turn lane length and stopping sight distance for the higher speed in the Speed (mph) column (45 mph vs. 35 mph, 55 mph vs. 50 mph). Speed and efficiency of mobility is emphasized for rural highways.

## Spacing Standards for Commercial Entrances and Intersections Near Interchange Ramps on Principal Arterials

Spacing Standards for Commercial Entrances and Intersections Near Interchange Areas on Multilane Principal Arterial Crossroads				
Type of Area	Spacing Dimension			
	X	Y	Z	M
Urban	750'	2640'	900'	990'
Rural	1320'	2640'	1320'	1320'

**TABLE 2-3 SPACING STANDARDS FOR COMMERCIAL ENTRANCES AND INTERSECTIONS NEAR INTERCHANGE AREAS ON MULTILANE PRINCIPAL ARTERIAL CROSSROADS**

For Other Functionally Classified Highways See Appendix C.

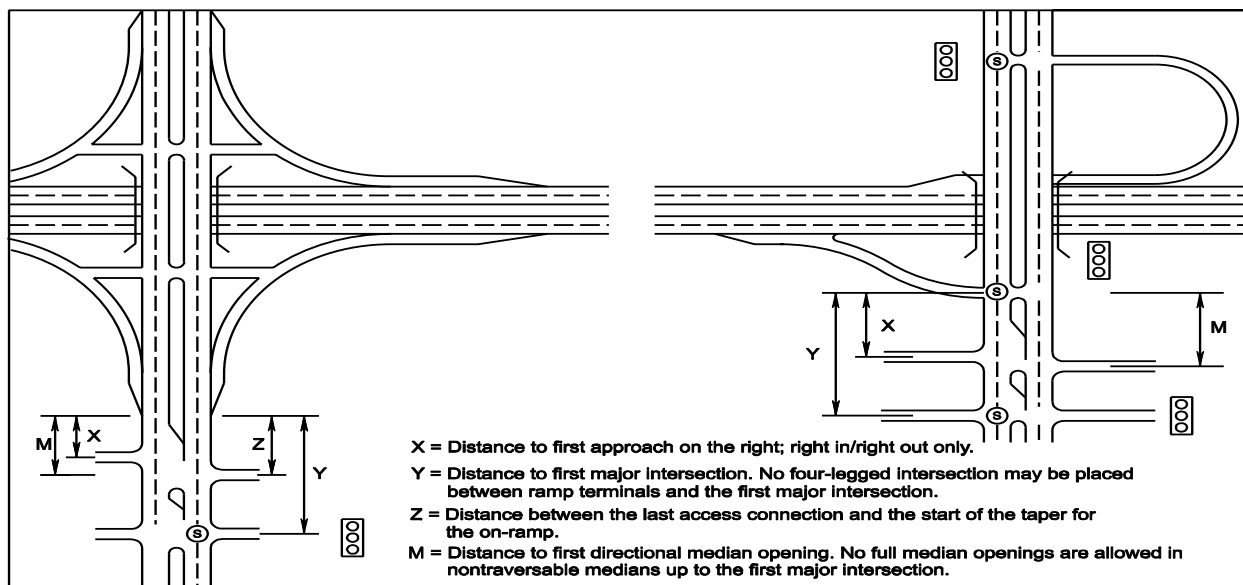

**FIGURE 2-9 ACCESS CONTROL ON MULTI LANE PRINCIPAL ARTERIALS AT INTERCHANGES**

Source: NCHRP Synthesis 332 Access Management on Crossroads in the Vicinity of Interchanges 2004.

NCHRP Report 420 Impacts of Access Management Techniques 1999.



Spacing Standards for Commercial Entrances and Intersections Near Interchange Areas on Two-Lane Principal Arterial Crossroads		
Type of Area	X or Z	Y
Urban	750'	1320'
Rural	1320'	1320'

**TABLE 2-4 SPACING STANDARDS FOR COMMERCIAL ENTRANCES AND INTERSECTIONS NEAR INTERCHANGE AREAS ON TWO-LANE PRINCIPAL ARTERIAL CROSSROADS**

**For Other Functionally Classified Highways See Appendix C.**

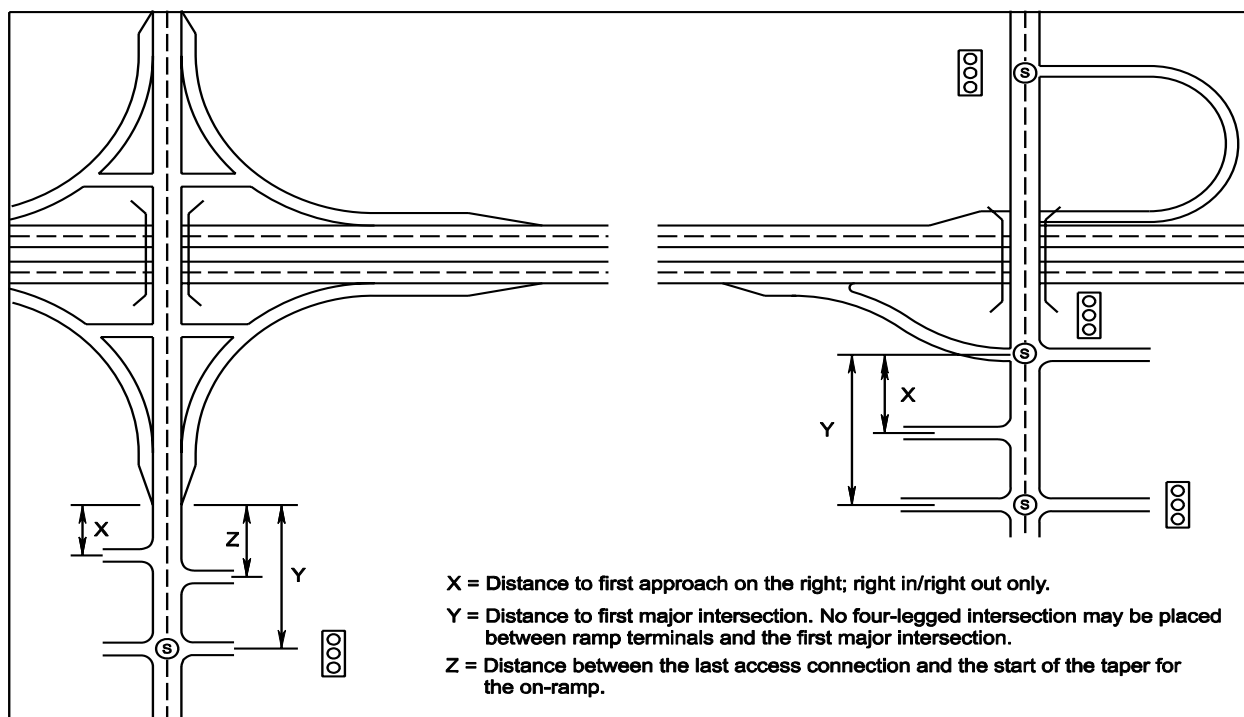

**FIGURE 2-10 ACCESS CONTROL ON TWO LANE PRINCIPAL ARTERIALS AT INTERCHANGES**

Source: NCHRP Synthesis 332 Access Management on Crossroads in the Vicinity of Interchanges 2004.  
 NCHRP Report 420 Impacts of Access Management Techniques 1999.

## Stopping Sight Distance

Stopping sight distances exceeding those shown in the table below should be used as basis for design wherever practical.

In computing and measuring stopping sight distances, the height of the driver's eye is estimated to be 3.5 feet and the height of the object to be seen by the driver is 2 feet, equivalent to the taillight height of a passenger car. The "K Values" shown are a coefficient by which the algebraic difference in grade may be multiplied to determine the length in feet of the vertical curve that will provide minimum sight distance.

For the minimum lengths of vertical curves for the recommended stopping sight distance for each design speed, and corresponding "K" values, see the AASHTO "Green Book".

Height of Eye 3.5'		Height of Object 2'								
Design Speed (mph) **	25	30	35	40	45	50	55	60	65	70
MINIMUM SIGHT DISTANCE (FEET)	155	200	250	305	360	425	495	570	645	730
MINIMUM K VALUE FOR:										
CREST VERTICAL CURVES	12	19	29	44	61	84	114	151	193	247
SAG VERTICAL CURVES	26	37	49	64	79	96	115	136	157	181

Source: 2004 AASHTO Green Book, pages 112, 113, 272 and 277

**TABLE 2-5 STOPPING SIGHT DISTANCE**

When a highway is on a grade, the sight distances in the table below should be used.

Design Speed (mph) **	Stopping Sight Distance on Grades					
	Downgrades			Upgrades		
	3%	6%	9%	3%	6%	9%
15	80	82	85	75	74	73
20	116	120	126	109	107	104
25	158	165	173	147	143	140
30	205	215	227	200	184	179
35	257	271	287	237	229	222
40	315	333	354	289	278	269
45	378	400	427	344	331	320
50	446	474	507	405	388	375
55	520	553	593	469	450	433
60	598	638	686	538	515	495
65	682	728	785	612	584	561
70	771	825	891	690	658	631

**TABLE 2-6 STOPPING SIGHT DISTANCE**

(See 2004 AASHTO Green Book, page 115)

The following table shows intersection sight distance requirements for various speeds along major roads:

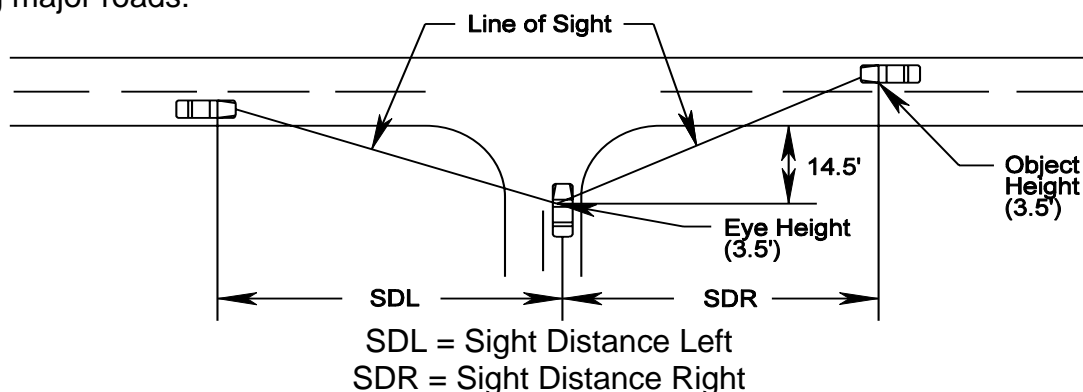

**Intersection Sight Distances**  
**(Along Major Roadway at Intersection with Minor Roadway,**  
**Crossovers and Commercial Entrances)**

Height of Eye 3.5'	Height of Object 3.5'										
Design Speed (mph) **	20	25	30	35	40	45	50	55	60	65	70
SDR: 2 Lane Major Road (Ft.)	225	280	335	390	445	500	555	610	665	720	775
SDR: 4 Lane Major Road (Undivided) or 3 Lane	240	295	335	415	475	530	590	650	710	765	825
SDR: 4 Lane Major Road (Divided – 18' Median)	260	325	390	455	515	580	645	710	775	840	905
SDR: 5 Lane Major Road	250	315	375	440	500	565	625	690	750	815	875
SDR: 6 Lane Major Road (Divided – 18' Median)	275	340	410	480	545	615	680	750	820	885	955
SDR: 6 All Conditions (Turning into 1 <sup>st</sup> lane)	195	240	290	335	385	430	480	530	575	625	670

**TABLE 2-7 INTERSECTION SIGHT DISTANCE**

Source: AASHTO Green Book (See next page for more detail)

\*\*For all tables, use legal speed limit unless the design speed is available and approved for use by VDOT.

The term "Major Road" refers to the road with the higher functional classification, or if both have the same classification, the road with the higher volume.

For major roadways of more than four lanes, large truck volumes on a minor road or crossover, or median widths over 60', see AASHTO's A Policy on Geometric Design of Highways and Streets.

Intersection sight distance does not control the access spacing for entrances and intersections shown in Table 2-2

The designer must check each intersection to insure that these values are obtained. On a typical two-lane road horizontal curve there are numerous objects that restrict sight distance such as cut slopes, buildings, vegetation, vehicles, etc. It is very possible to have sight distance in the winter and not in the spring or summer due to the growth of vegetation. Additional clearance along the line of sight may be needed.

These obstructions should be considered when reviewing commercial entrances. A divided highway can have similar problems. It is very important to obtain adequate commercial entrance sight distance from the entrance as well as the left turn position into the entrance. A design exception must be granted by the State Location and Design Engineer (or designee), and if applicable, the Federal Highway Administration for deviating from required sight distance standards.

Intersection Sight Distance values in the table above permit a vehicle stopped on minor road or crossover, to cross the major road safely or merge safely in the case of turns.

The Intersection Sight Distance table above is based on the following criteria:

The AASHTO Green Book shows that it requires 7.5 seconds for a passenger car to turn left onto a two-lane road. For each additional lane to be crossed – add 0.5 seconds. Therefore:

2 Lane Major Road (crossing one lane)	Taken directly from 2004 AASHTO, Exhibit 9-55, Page 661 (stopped car crossing one lane and turning left onto a highway with no median) $1.47 \times (\text{speed}) \times 7.5$ (per pg. 660) = SD
4 Lane Major Road (crossing two lanes)	Taken directly from 2004 AASHTO, Exhibit 9-64, Page 672 (stopped car crossing two lanes and turning left onto a highway with no median) $1.47 \times (\text{speed}) \times 8.0$ (per pg. 660) = SD
4 Lane Major Road Divided – 18' median (crossing 2 lanes + 18')	See 2004 AASHTO, page 664 Based on 18' median (widest median without provision for stopping) Page 664 says to add 0.5 seconds "for narrow medians that cannot store the design vehicle". 18' = 1 ½ Lanes to cross, or $7.5 + .5 + .75 = 8.75$ ; therefore: $1.47 \times (\text{speed of approach roadway}) \times 8.75 = \text{SD}$

**TABLE 2-8 INTERSECTION SIGHT DISTANCE CRITERIA**

### **Median Openings/Crossovers (With and Without Connections)**

In commercial and industrial areas where property values are high and rights of way for wide medians are difficult to acquire a paved flush traversable median 10' to 16' wide is the optimum design. The shape of the median end should generally be symmetrical when the median width is less than 10' and the median opening length is not excessive, but the bullet nose can be effectively used to reduce the opening. For a median width of 10' or more, the bullet nose design should be used instead of a semicircular design at 3-leg and 4-leg intersections. The length of the crossover and the shape of the median end are controlled by the width of the median and the turning radii. A wide median opening can be reduced at skewed intersections by utilizing modifications of the bullet nose design. Additional information may be obtained from the Access Spacing Table 2-2 and AASHTO's A Policy on Geometric Design of Highways and Streets (Median Openings). New crossovers must demonstrate that left-turn storage space is met. Use appropriate turning movement software for analysis (such as Auto-Turn).

### **Crossover Location Approval Process**

Tables 2-2 through 2-7 show minimum crossover spacing and sight distance requirements to be applied on all divided highways without full control of access. Crossovers not meeting these minimums will only be allowed after an individual traffic safety and operational study and approval as outlined below.

The following are some factors, but not all inclusive, that should be considered in the study, if applicable: Operating speed, volume of traffic for crossover and through routes, signal operation/progressions, accidents with and without additional crossover, number of U-turns, weaving maneuvers, alternative solution, capacity analysis, type of vehicles such as school buses, trucks, etc.

Intersection sight distance determinations apply both horizontally and vertically, measured in each direction, and are to be based on a height of driver's eye of 3.5' and a height of object 3.5'.

As part of a highway construction project, crossover spacing less than shown as minimum in Table 2-2 for Principal Arterial Highways, will be considered when required by existing intersecting public highways or streets with a current ADT of 100 or greater. All plans at the public hearing stage are to show only those crossovers at public highways and streets which meet these criteria or at other locations that preliminary planning and traffic studies have warranted. The determination of additional crossovers will be the result of field inspection recommendations of the District Administrator, the State Traffic Engineer, (or other appropriate Engineer) and the State L&D Engineer. The approval of the crossovers is the responsibility of the State Traffic Engineer and the State L&D Engineer, with the final responsibility for the location of crossover layout on plans resting with the State L&D Engineer. Plans at right of way stage are to indicate the crossovers as determined and approved by the above criteria. Any plans that are

revised during construction for the addition or deletion of crossovers shall be approved as indicated above.

For non-project related crossover requests, traffic studies as outlined above must accompany the request for a crossover location that does not meet the minimum spacing standards as shown in Table 2-2. The approval of the addition or deletion of crossovers will be the responsibility of the State Traffic Engineer (or other appropriate Engineer) with the concurrence of the State Location and Design Engineer. It will be the responsibility of the State Traffic Engineer to coordinate such changes with the State Location and Design Engineer in order that these revisions of crossovers may be properly recorded on the original plans.

### Crossover Grades

On divided highways with depressed medians, there are generally three methods by which superelevation is determined for the opposing traffic lanes.

One method is for the median pavement edges to be held at the same, or close to the same elevation. A second method is for each baseline elevation to be approximately the same, with a corresponding difference in elevation of the median pavement edges. The third method is for the superelevation of all lanes to be obtained along a single plane. Thus, the grade of the lane on the outside of the curve is higher than the inside lane. The various methods are illustrated below.

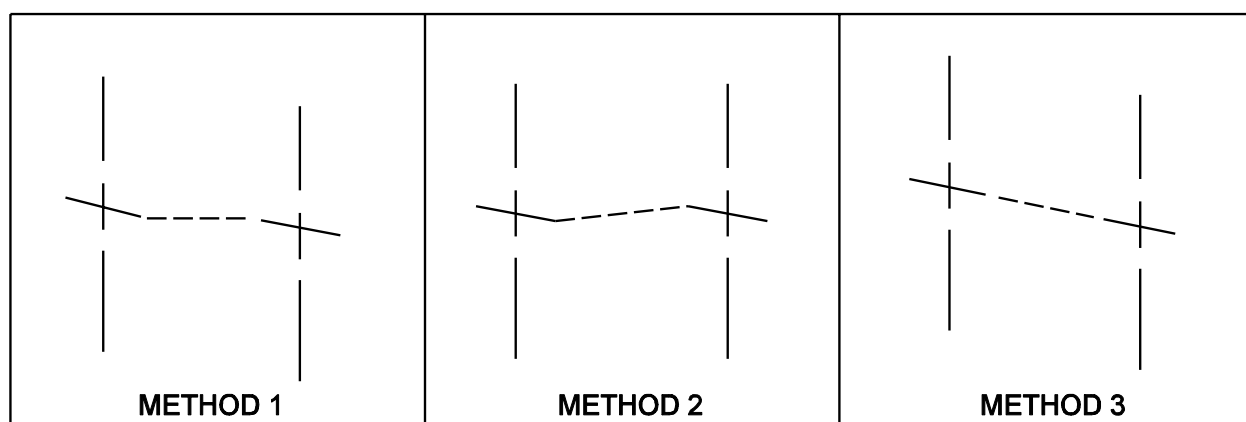

The designer is to study the requirements of each particular situation. In the case of a facility without crossovers, the first method above is generally acceptable on superelevated curves. This will allow the median area to be properly graded without creating an adverse design situation.

Method 2 generally results in an undesirable situation and must be used with caution.

In a case where a crossover is proposed, particularly in conjunction with a connecting road within the limits of a superelevated curve, the designer shall pay particular attention to the patch which must be traversed by vehicles using the crossover.

In most cases, the application of the superelevation in a single plane (Method 3) is the acceptable method. This will allow a vehicle to cross from one lane to the other without

negotiating several different gradients. As noted, herein, this will require the adjustment of the mainline grades.

The desirable grade on a crossover is between 0.5% and 5%. The maximum grade should never exceed 10% as safe turning movements above this level are difficult. It is especially important at locations, such as truck stops and other businesses generating large vehicular traffic, that crossover grades fall in the category of less than 5%. A desirable maximum algebraic difference of a crossover crown line is 4 or 5 percent, but it may be as high as 8 percent at the locations where there are few trucks or school buses and low speeds. Additionally, sight distances must be checked for values shown in the table for "Sight Distances along Major Road at Intersection with Minor Road and Crossovers and Commercial Entrances", see Table 2-7. Any deviation from these values is to be brought to the attention of the State Location and Design Engineer.

The grade on a crossover is measured from the edge of shoulder to the edge of shoulder, unless left turn lanes are provided, in which case the grade is applied from the edge of pavement of the left turn lanes to the edge of pavement of the opposite left turn lane. This is more clearly shown in the following diagram:

Determination of Grade on a Crossover



In preparing plans for field inspection, the gradient at each crossover is to be plotted graphically.

### Intersecting Cross Road Grades

The grade of a connecting facility must be carefully studied when approaching an intersection where the mainline is superelevated. A smooth grade tie-in is desirable, with sufficient area on a relatively flat grade for a vehicle to stop before entering the main roadway. Also, when a connection is on the outside of a superelevated curve, the grade must be designed so that the connection is visible to a driver on the main roadway desiring to turn onto the connections.

Every attempt must be made to provide an adequate area for this vehicular stoppage, giving full consideration to the horizontal and vertical sight distances.

The desirable tie-in is one that is no steeper than the pavement cross slope whether this is superelevated or the normal crown. The maximum difference between the pavement cross slope and the approach road grade shall not exceed 8% at stop intersections or 4% at continuous-movement intersections. The stoppage area should be a minimum of 50' before beginning the steeper grade. (See AASHTO's A Policy on Geometric Design of Highways and Streets).

## **Roundabouts**

Roundabouts are circular intersections with specific design and traffic control features. These include yield control of all entering traffic (circulating vehicles have the right of way), channelized approaches, and geometric curvature to ensure that travel speeds are typically less than 30 mph (single lane 20-25 mph; double lane 25-30 mph).

Roundabouts are generally safer than other types of intersections for low and medium traffic conditions. These safety benefits are achieved by eliminating vehicle crossing movements through the conversion of all movements to right turns and by requiring lower speeds as motorists proceed into and through the roundabout. The potential for right angle and left turn head-on crashes is eliminated with single lane roundabouts. Single lane roundabouts are safer than double lane roundabouts due to more complex decisions for entering and especially for exiting a double lane roundabout.

While roundabouts usually require more pavement area at the intersection, they require less pavement area on the upstream approaches and downstream exits. At new intersection sites that will require turn lanes a roundabout can be a less expensive intersection alternative. Operating and maintenance costs are less than signalized intersections since there is no signal equipment. The roundabout has aesthetic advantages over other intersection types particularly when the center island is landscaped.

Because roundabouts treat all vehicle movements equally (each approach is required to yield to circulating traffic), a roundabout that will serve the intersection of a higher volume major roadway and a lower volume minor street (e.g. principal arterial vs. collector) can cause traffic delays and stopped queues on the major roadway. Consequently, functional classification (hierarchy) of the intersecting roads needs to be assessed when considering the construction of a roundabout.

The Road Design Manual, Appendix B, Section B and Appendix C, Section C-1 contain guidelines on the design of a roundabout and the VDOT approval process. For subdivision streets and secondary highways, roundabouts can be approved by the District for design volumes up to 10,000 VPD. Higher volume designs should be submitted to the Central Office Roundabout Review Committee, which will make recommendations to the State Location and Design Engineer for approval or disapproval. The process for primary and urban highways is similar.

### **References for Section 2: Intersections**

1. "Highway Capacity Manual" Special Report 209, Transportation Research Board, National Research Council, Washington, D.C. (2000).
2. Manual of Uniform Traffic Control Devices for Streets and Highways, Federal Highway Administration, Washington, D.C. (2003).
3. Levinson, H.S. "The Capacity of Shared Left Turn Lanes" Transportation Research Record 1225. Transportation Research Board, National Research Council, Washington, D.C. (1989).
4. Roundabouts: An Informational Guide, Federal Highway Administration, Washington D.C. (2000).



## SECTION 3 – TURNING LANES

### Left and Right Turn Lane Criteria

As a general policy, left-turn lanes are to be provided for traffic in both directions in the design of all median crossovers on non-access controlled four-lane or greater divided highways using controls as shown in Figure 3-1 and adjusted upward as determined by Figure 3-1 or by capacity analysis for left-turn storage. Left-turn lanes should also be established on two-lane undivided highways where needed for storage of left-turn vehicles and/or prevention of thru-traffic delay as shown in Figure 3-1 and adjusted upward as determined by Table 3-1 and Figure 3-4 through 3-21 or by capacity analysis for left-turn storage.

LENGTH OF STORAGE		TAPER - Rural and Urban	
Rural - For Design Speeds 50 MPH or Higher	*L - 200' min. (For 240 or fewer vehicles during peak hour, <u>making turn</u> )	- For Design Speeds 35 MPH or Higher	**T - 200' Min.
- For Design Speeds 45 MPH Less than	*L - 100' min. (For 60 or fewer vehicles during peak hour, <u>making turn</u> )	- For Design Speeds 30 MPH or Less	**T - 100' Min.
*Distance L to be adjusted upward as determined by capacity analysis for Left and Right Turn Storage.		**Tapers are to be straight-line unless local policy requires reverse curves. In congested areas the taper length may be reduced to increase storage length.	
Urban - Length determined by capacity analysis for Left and Right Turn Storage			

### FIGURE 3-1 LEFT AND RIGHT TURN LANE CRITERIA

(To be used for divided and undivided highways)

(However, VDOT minimum standards for storage length (45 mph) is 100 feet)

Taper rates: 8:1 for design speeds up to 30 mph and 15:1 for design speeds between 35 and 50 mph. (Source: 2004 AASHTO "Green Book", page 716).

Note: Taper lengths shown above were compiled using these formulas and were rounded up.

#### For Four-Lane Highways

\*Dimension "L" to be adjusted upward as determined by Figure 3-1 or by capacity analysis for left-turn storage lanes on four-lane or greater (divided) highways.

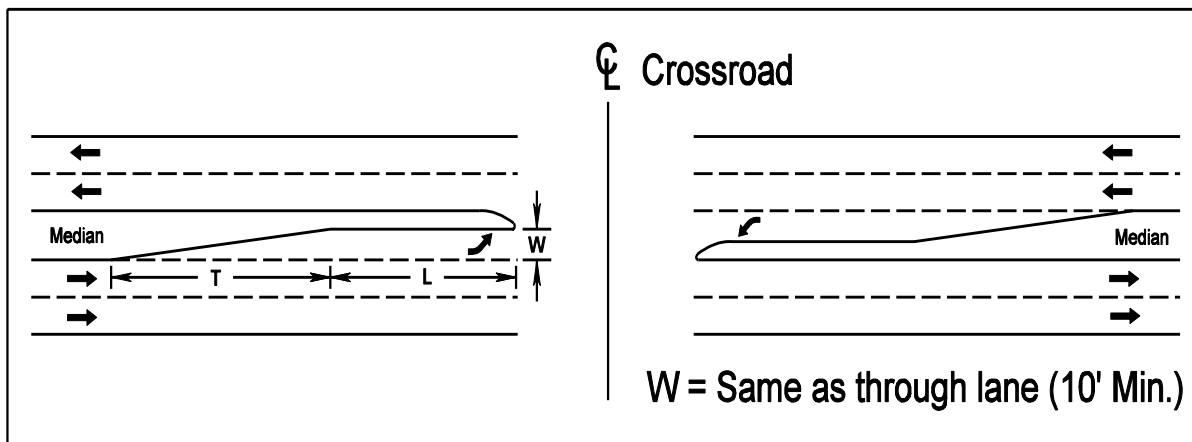

**FIGURE 3-2 LEFT AND RIGHT TURN STORAGE AND TAPER LENGTHS**

### For Two-lane Highways

Dimension "L" to be adjusted upward as determined in the table or by a capacity analysis for left-turn storage. A capacity analysis is defined as a detailed analysis of the location in accordance with the guidelines contained in the current issue of the Highway Capacity Manual for intersection capacity and signalization requirements.

In general, when left-turn volumes are higher than 100 VPH, an exclusive left-turn should be considered.

Dual left-turn lanes should be considered when left turn hourly volumes exceed 300 VPH.

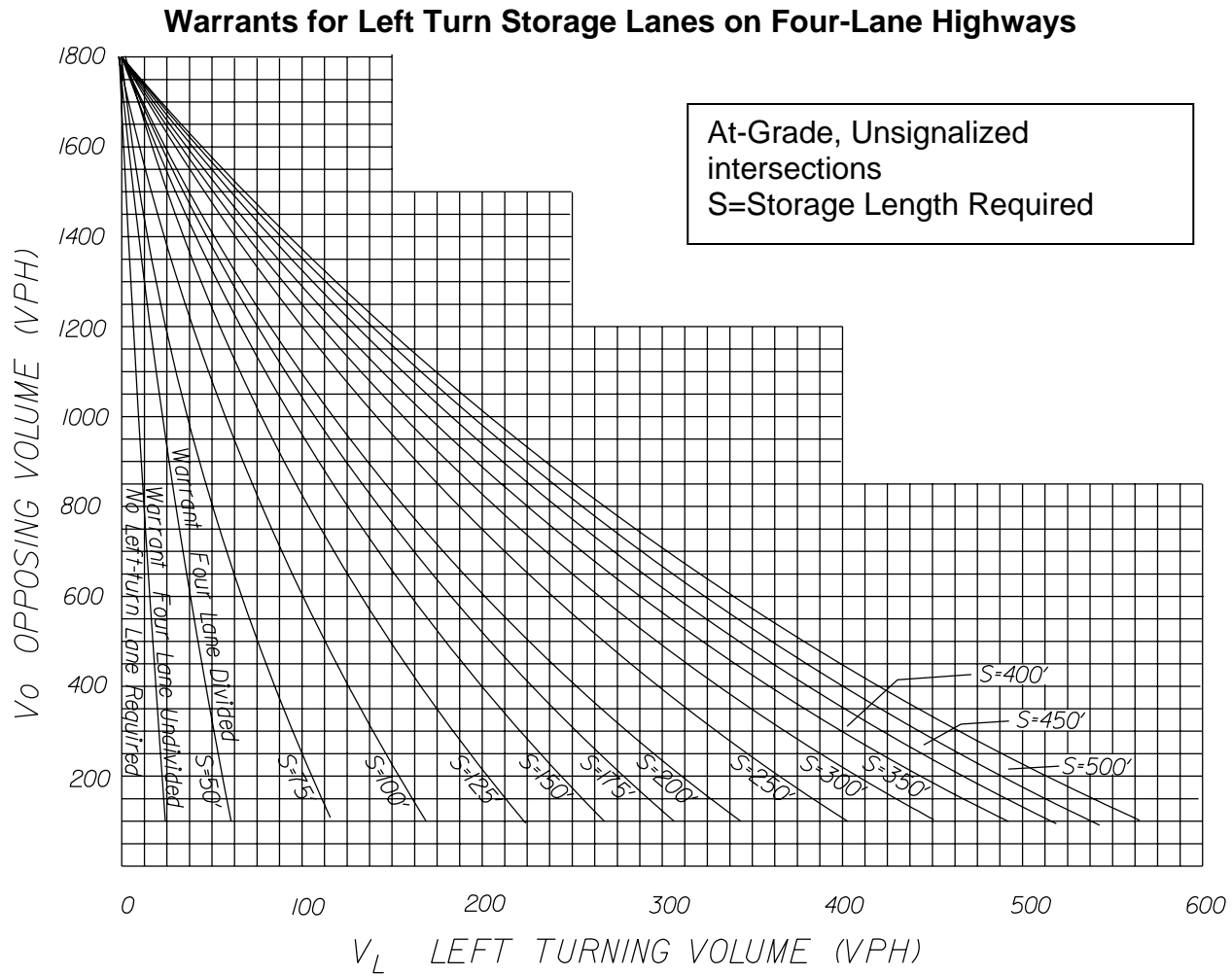

**FIGURE 3-3 WARRANTS FOR LEFT TURN STORAGE LANES ON FOUR-LANE HIGHWAYS**

Figure 3-3 was derived from Highway Research Report No. 211.

When the Average Running Speed on an existing facility is available, the corresponding Design Speed may be obtained from IIM LD- 117.

For plan detail requirements when curb and/or gutter are used, see VDOT's Road Design Manual, Section 2E-3.

Left-turn lanes should also be established on two-lane highways where traffic volumes are high enough to warrant them.

### Warrants for Left-Turn Storage Lanes on Two-Lane Highways

The warrants in table below are taken from the 2004 AASHTO "Green Book", Page 685, Exhibit 9-75. They were derived from Highway Research Report No. 211, Figures 2 through 19, for required storage length determinations.

The No. 211 study was undertaken to provide consistent volume warrants for left-turn storage lanes at unsignalized intersections.

### WARRANTS FOR LEFT-TURN LANES ON TWO-LANE HIGHWAYS

VPH OPPOSING VOLUME	ADVANCING VOLUME			
	5% LEFT TURNS	10% LEFT TURNS	20% LEFT TURNS	30% LEFT TURNS
	40-MPH DESIGN SPEED*			
800	330	240	180	160
600	410	305	225	200
400	510	380	275	245
200	640	470	350	305
100	720	515	390	340
	50-MPH DESIGN SPEED*			
800	280	210	165	135
600	350	280	195	170
400	430	320	240	210
200	550	400	300	270
100	615	445	335	295
	60-MPH DESIGN SPEED*			
800	230	170	125	115
600	290	210	160	140
400	365	270	200	175
200	450	330	250	215
100	505	370	275	240

**TABLE 3-1**

Source: Adapted from 2004 AASHTO Green Book, Page 685, Exhibit 9-75

\* USE DESIGN SPEED IF AVAILABLE, IF NOT USE LEGEL SPEED LIMIT.

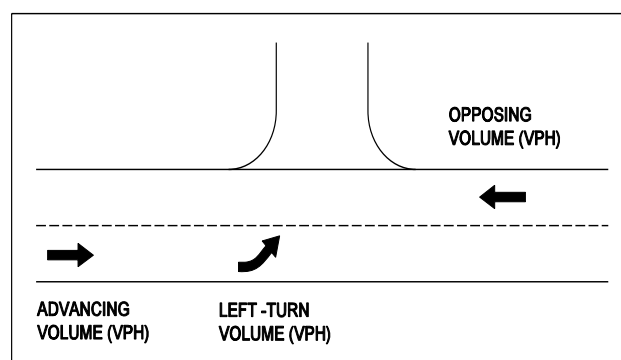

Example:

Two-lane highway with 40-MPH operating speed

Opposing Volume (VPH) - 600  
 Advancing Volume (VPH) - 440  
 Left-Turn Volume (VPH) - 44 or 10% of Advancing Volume

With opposing volume (VPH) of 600 and 10% of advancing volume (VPH) making left turns, and advancing volume (VPH) of 305 or more will warrant a left-turn lane.

Figure 3-5 (page 41) denotes that a 100' storage length is required.

The figures below provide warrants for left-turn storage lanes on two-lane highways based on 5 to 30 percent left-turn volumes and design speeds of 40, 50, and 60 MPH. Additional storage length is required for 10 to 50 percent truck volumes.

Intersections with poor visibility and/or a bad accident record may require the designer to use engineering judgment when volume conditions alone do not warrant a storage lane.

Additionally, the functional classification of the highway shall be considered so that the impact of turning movements on highways intended to serve through traffic is minimized.

### WARRANT FOR LEFT-TURN STORAGE LANES ON TWO-LANE HIGHWAYS

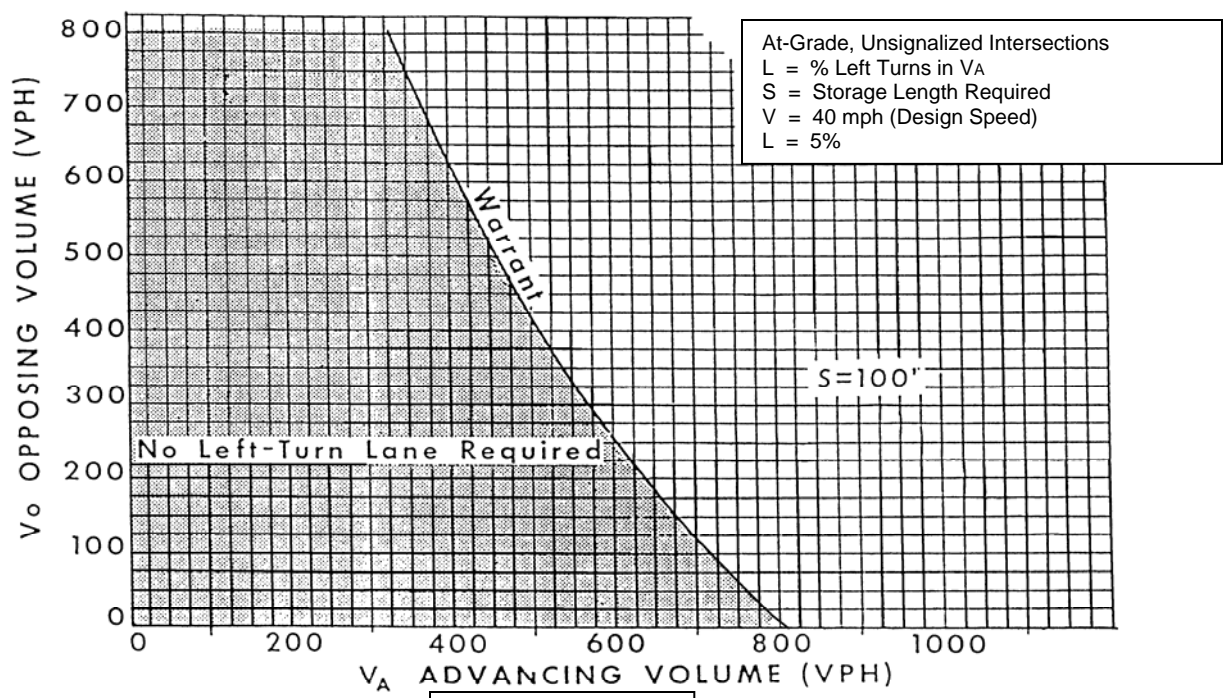

**FIGURE 3-4**

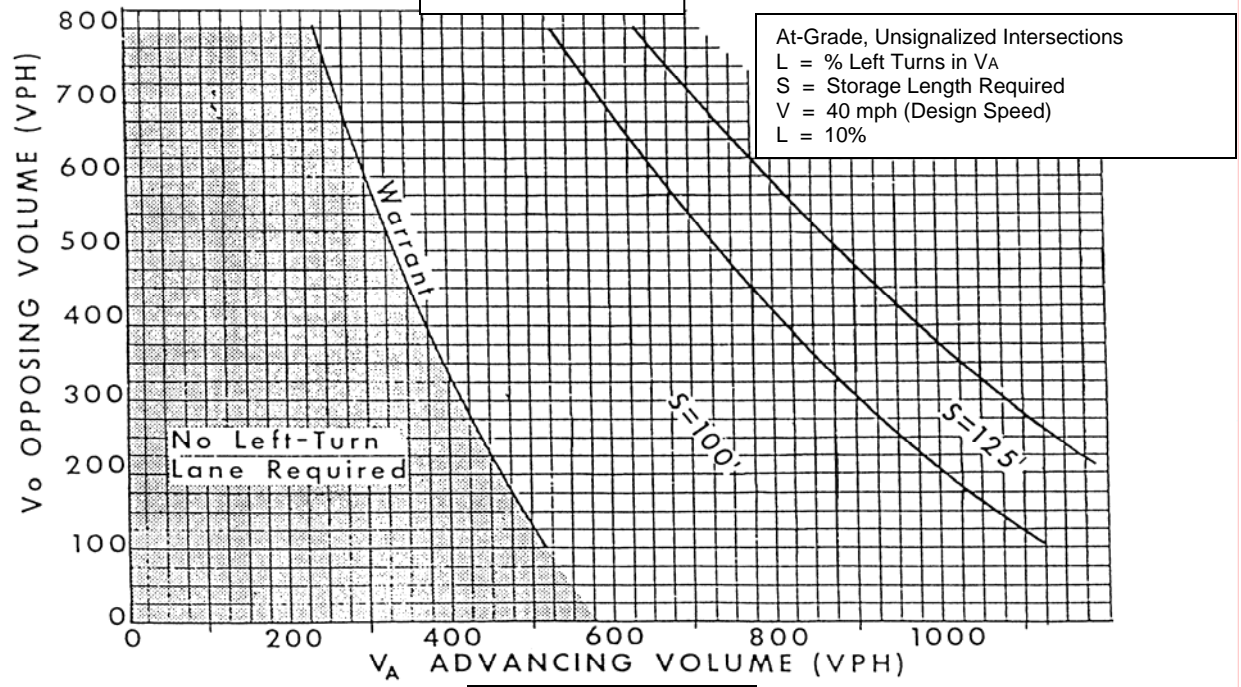

**FIGURE 3-5**

# WARRANT FOR LEFT-TURN STORAGE LANES ON TWO-LANE HIGHWAYS

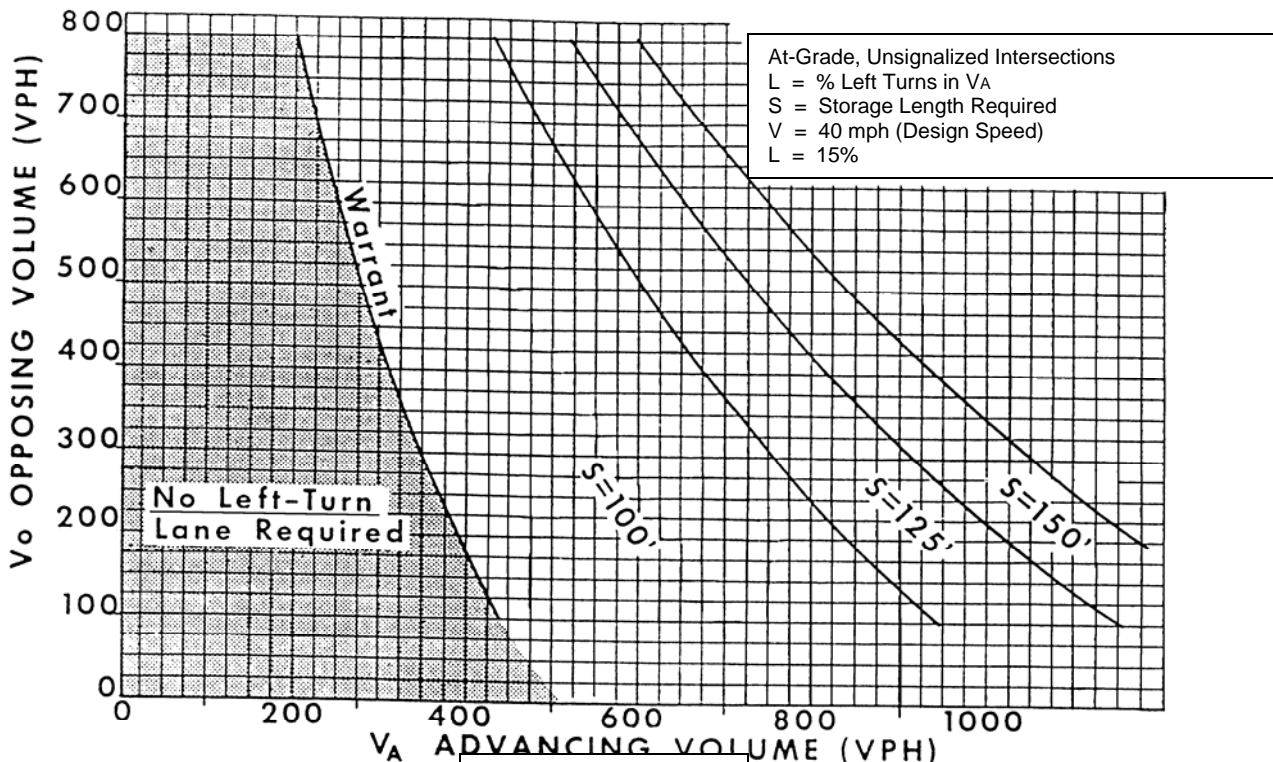

FIGURE 3-6

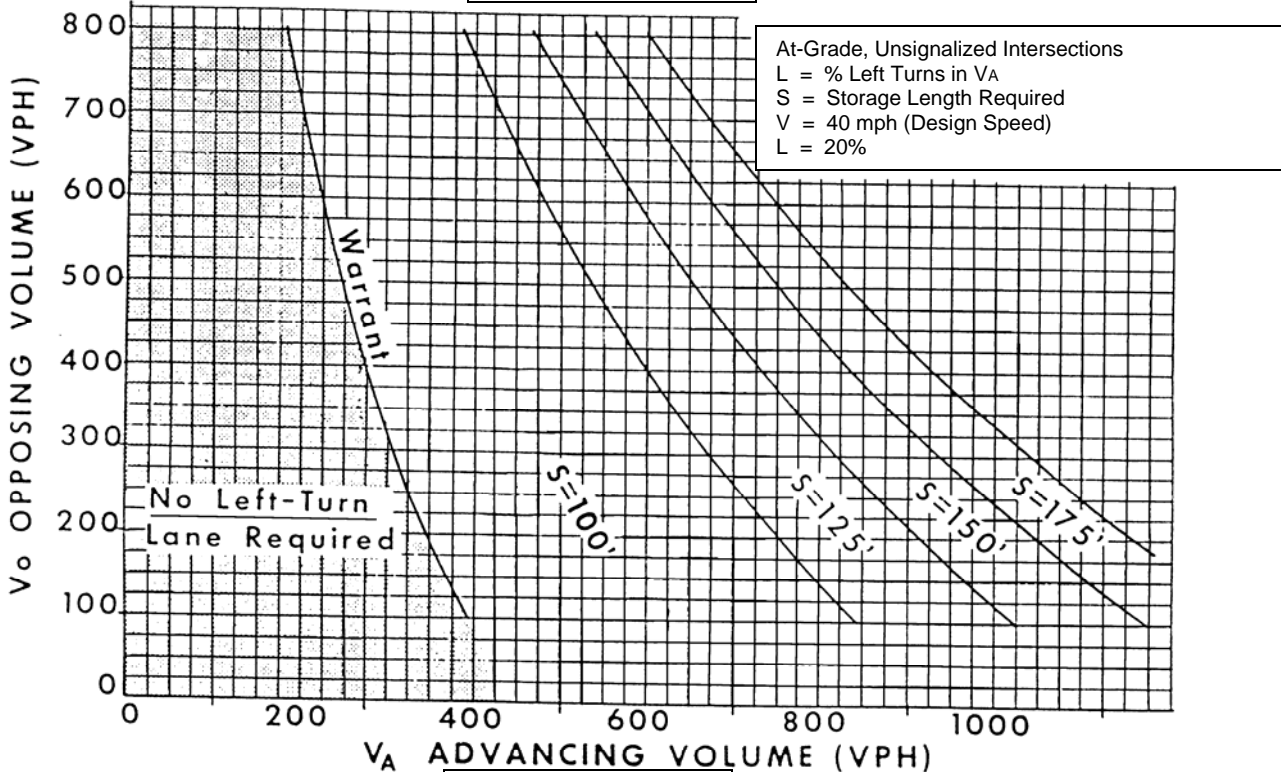

FIGURE 3-7

### WARRANT FOR LEFT-TURN STORAGE LANES ON TWO-LANE HIGHWAYS

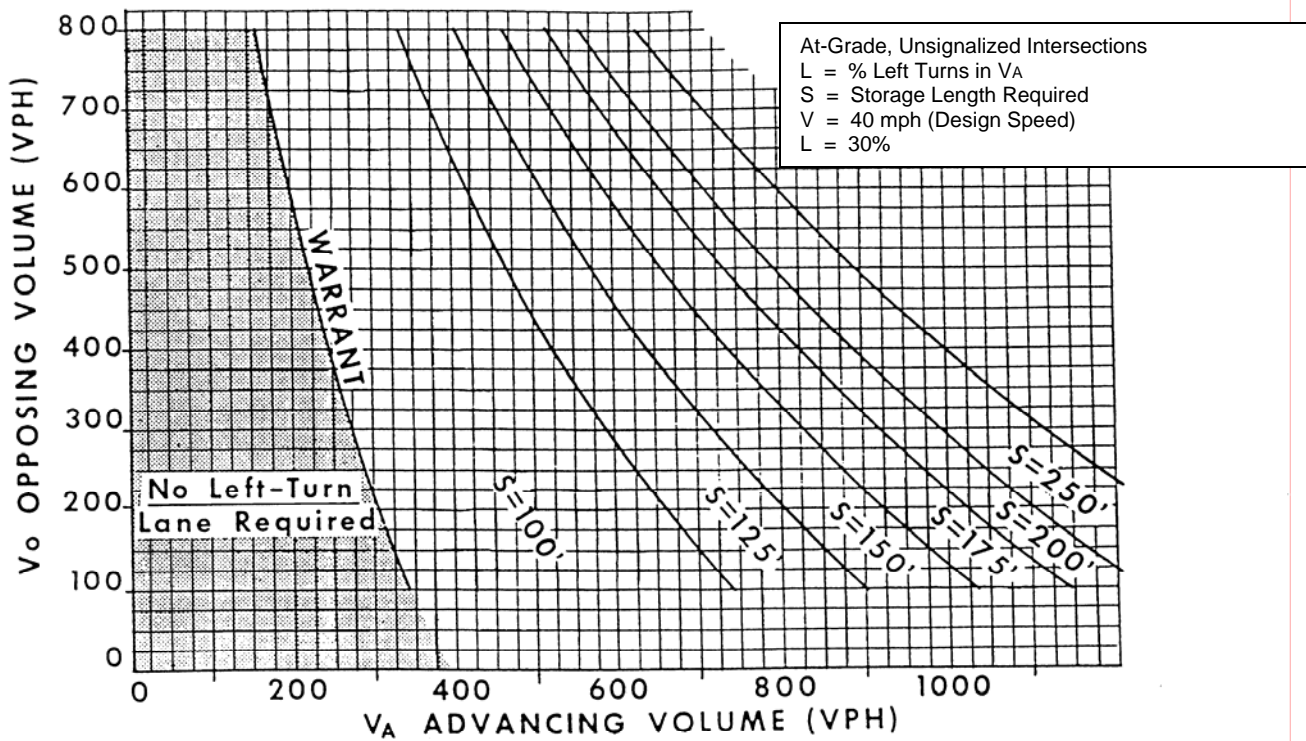

FIGURE 3-8

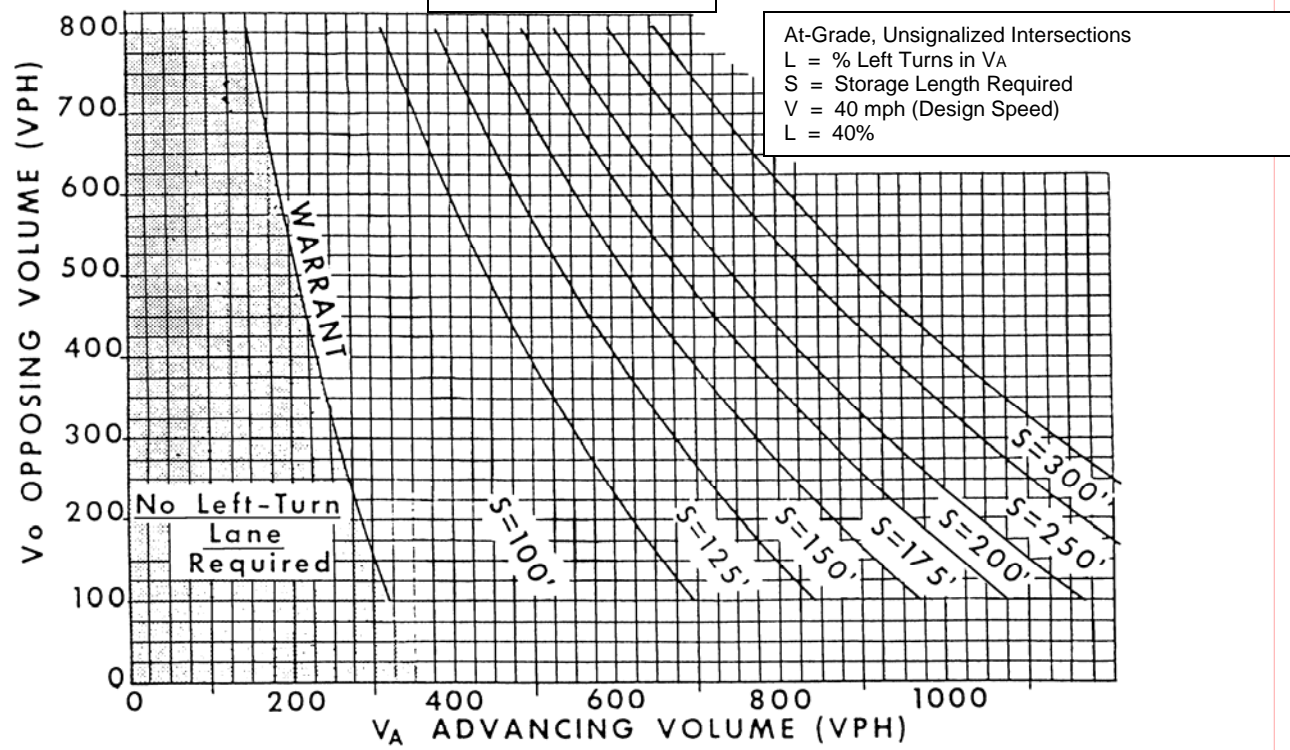
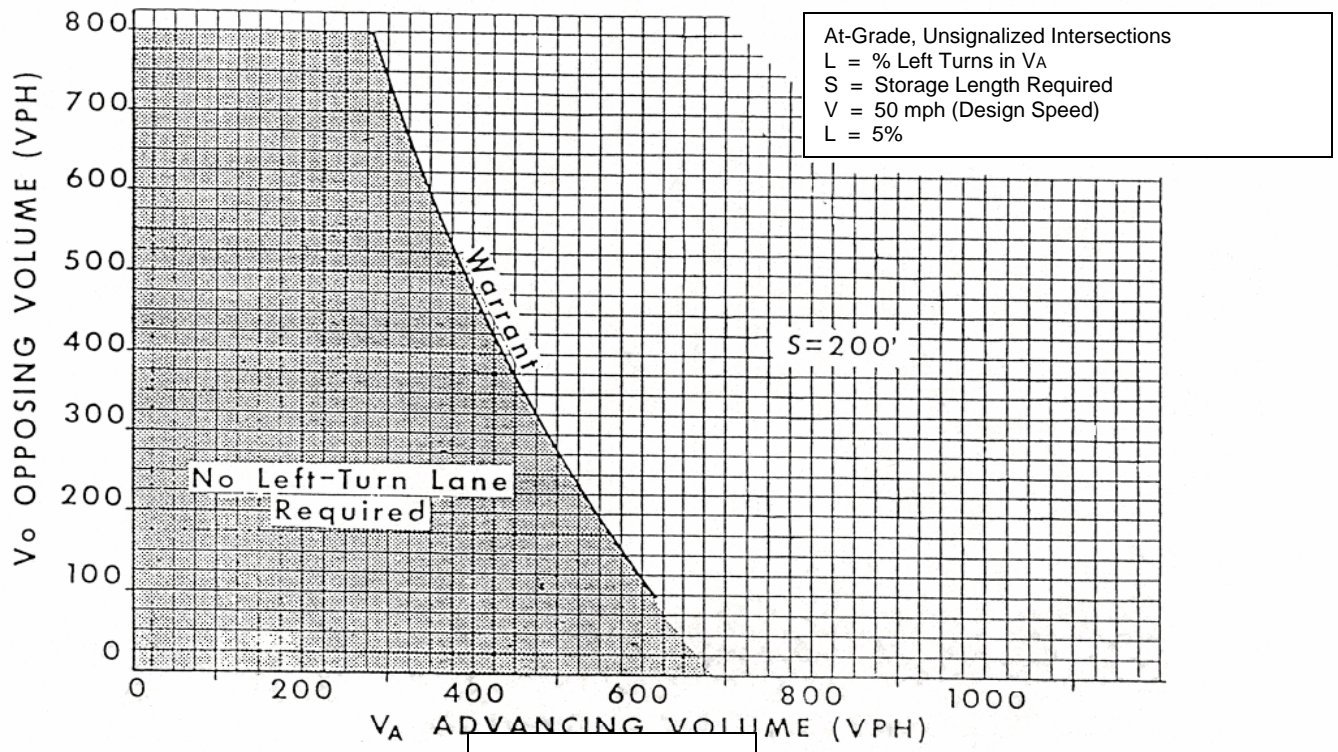

FIGURE 3-9



### WARRANT FOR LEFT-TURN STORAGE LANES ON TWO-LANE HIGHWAYS



**FIGURE 3-10**

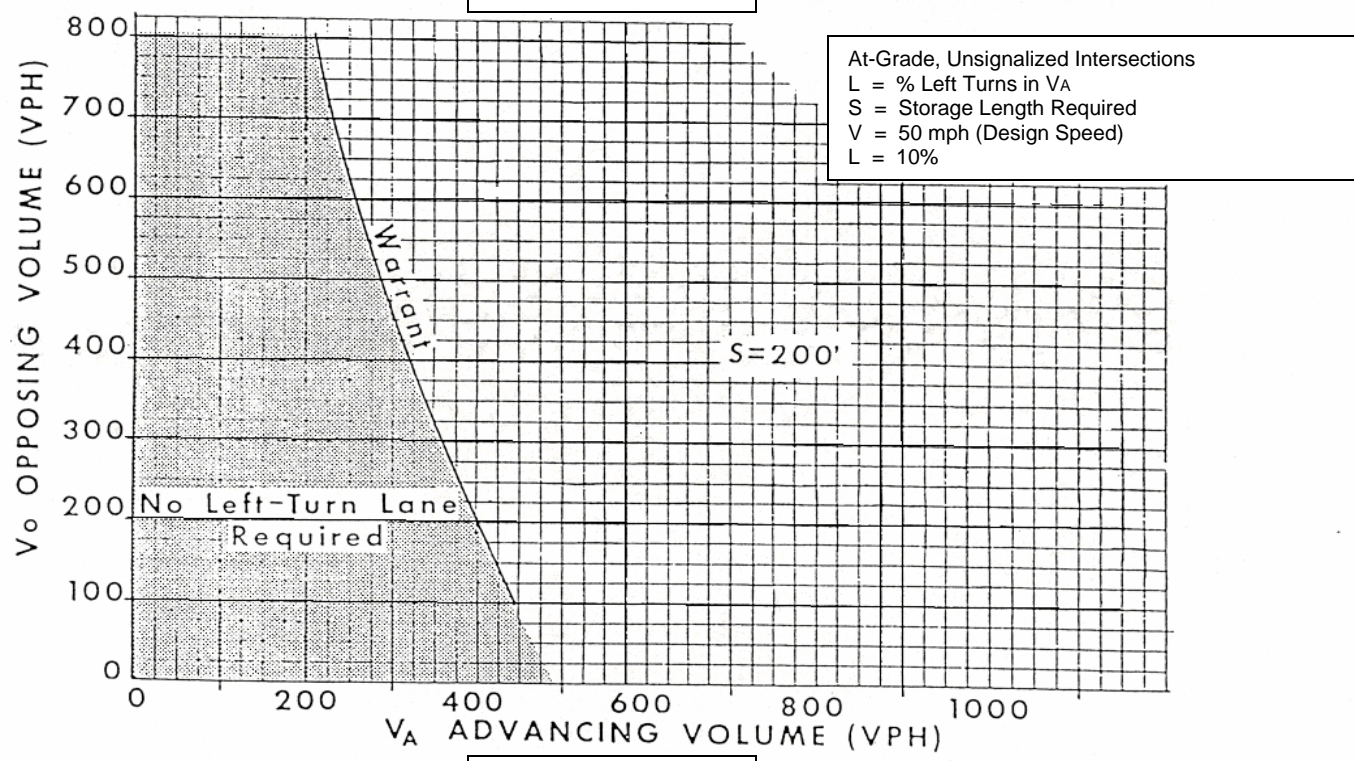

**FIGURE 3-11**

### WARRANT FOR LEFT-TURN STORAGE LANES ON TWO-LANE HIGHWAYS

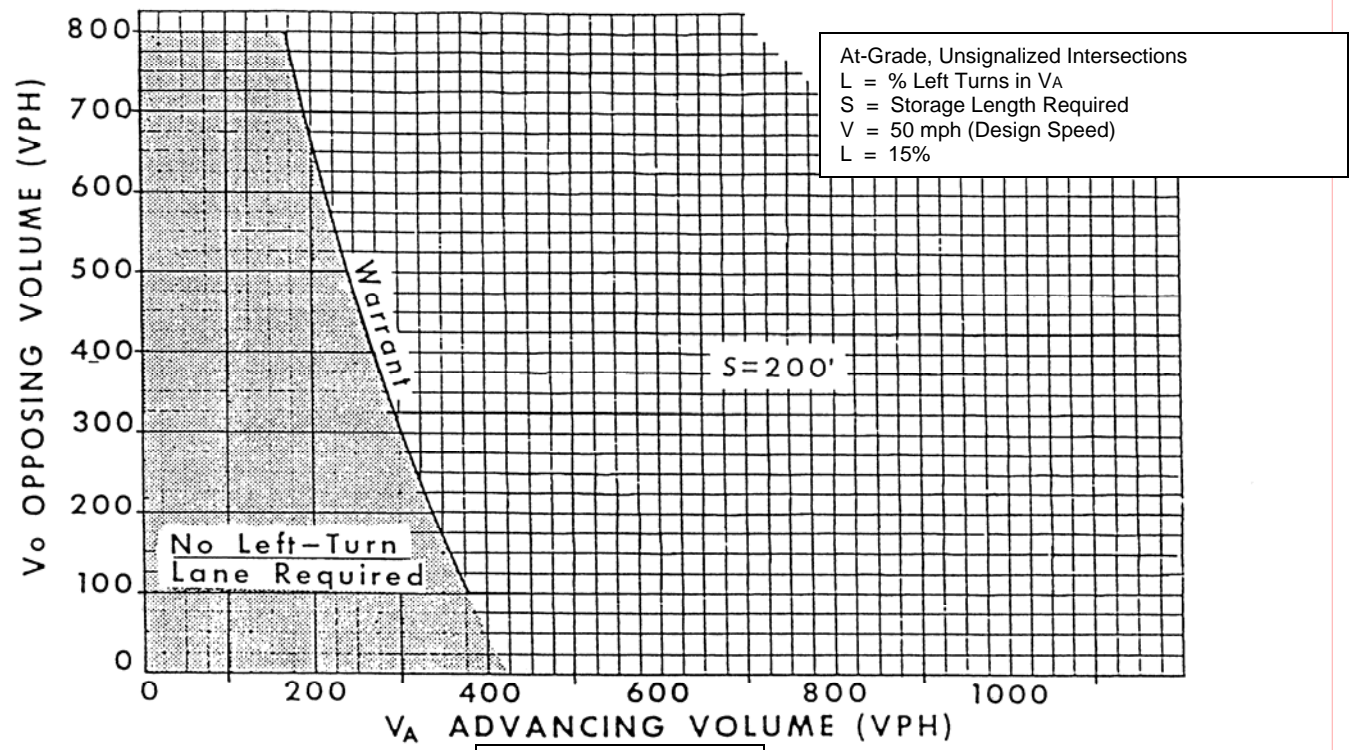

FIGURE 3-12

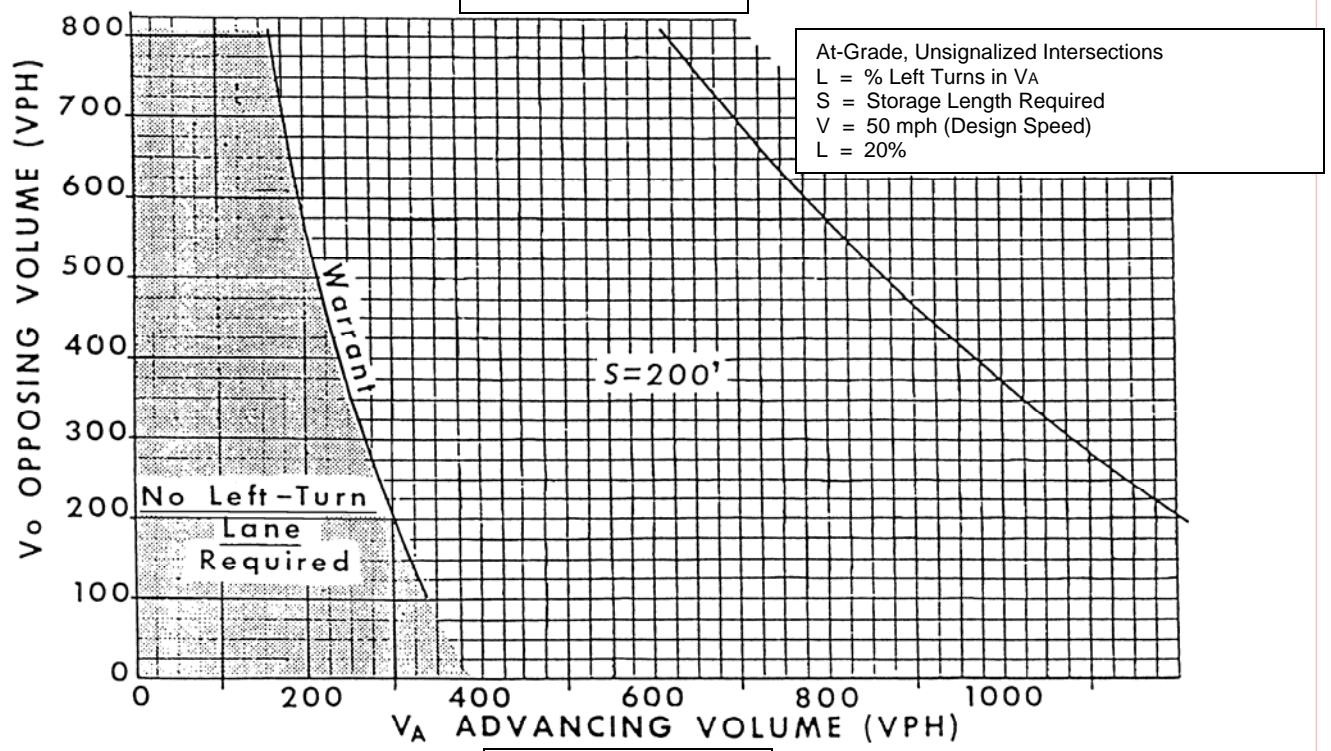
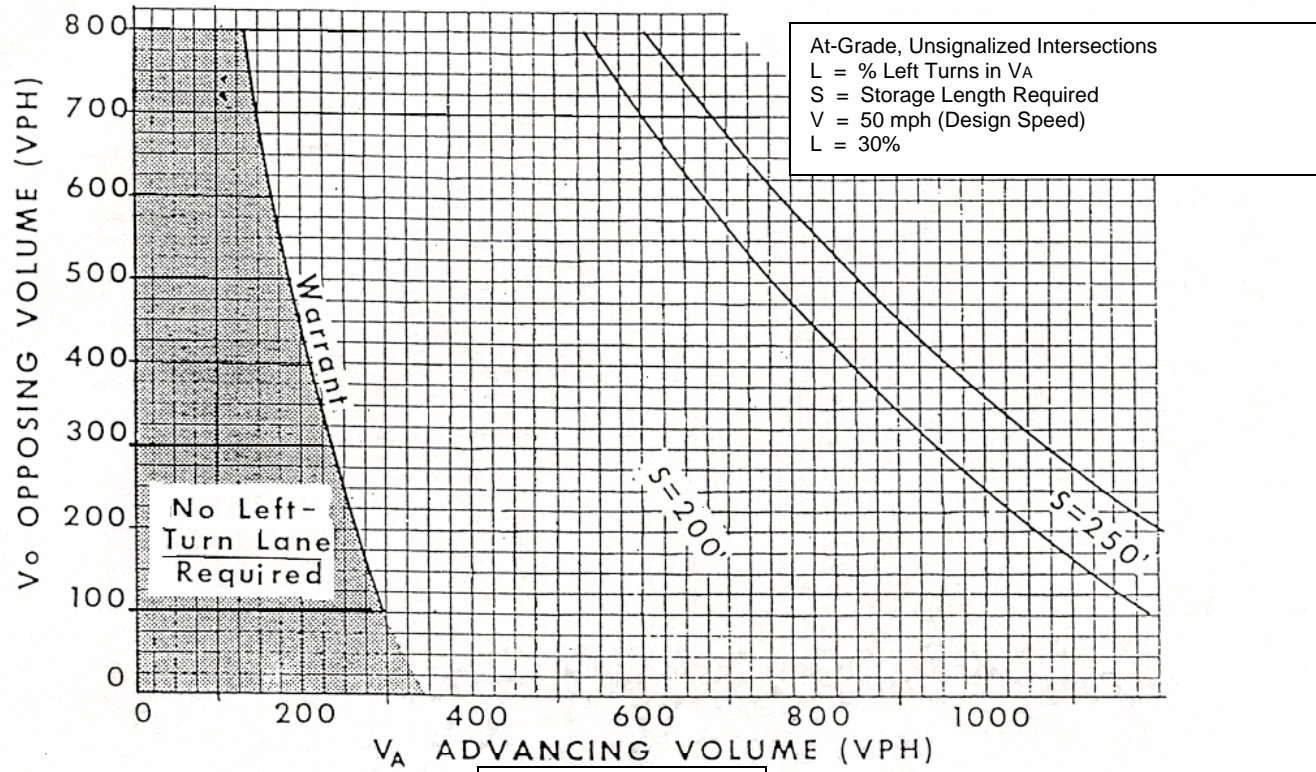
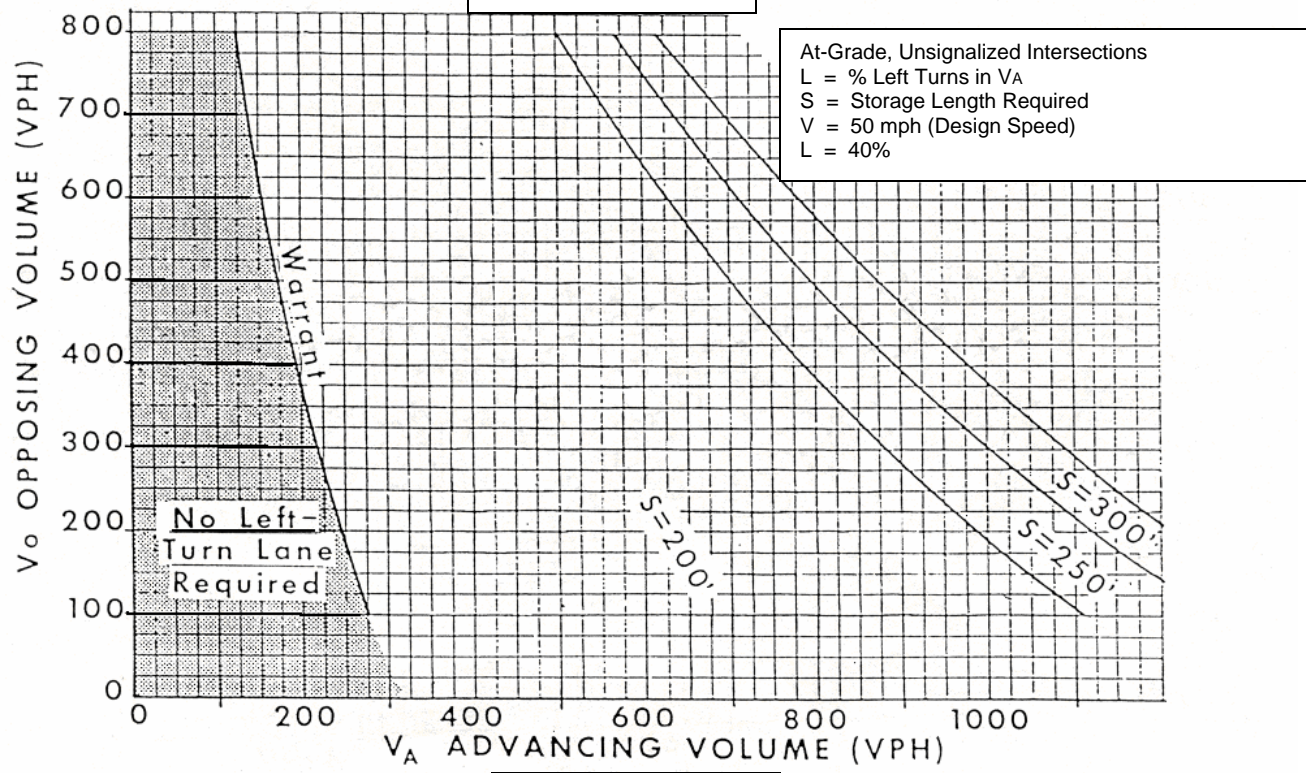

FIGURE 3-13

### WARRANT FOR LEFT-TURN STORAGE LANES ON TWO-LANE HIGHWAYS

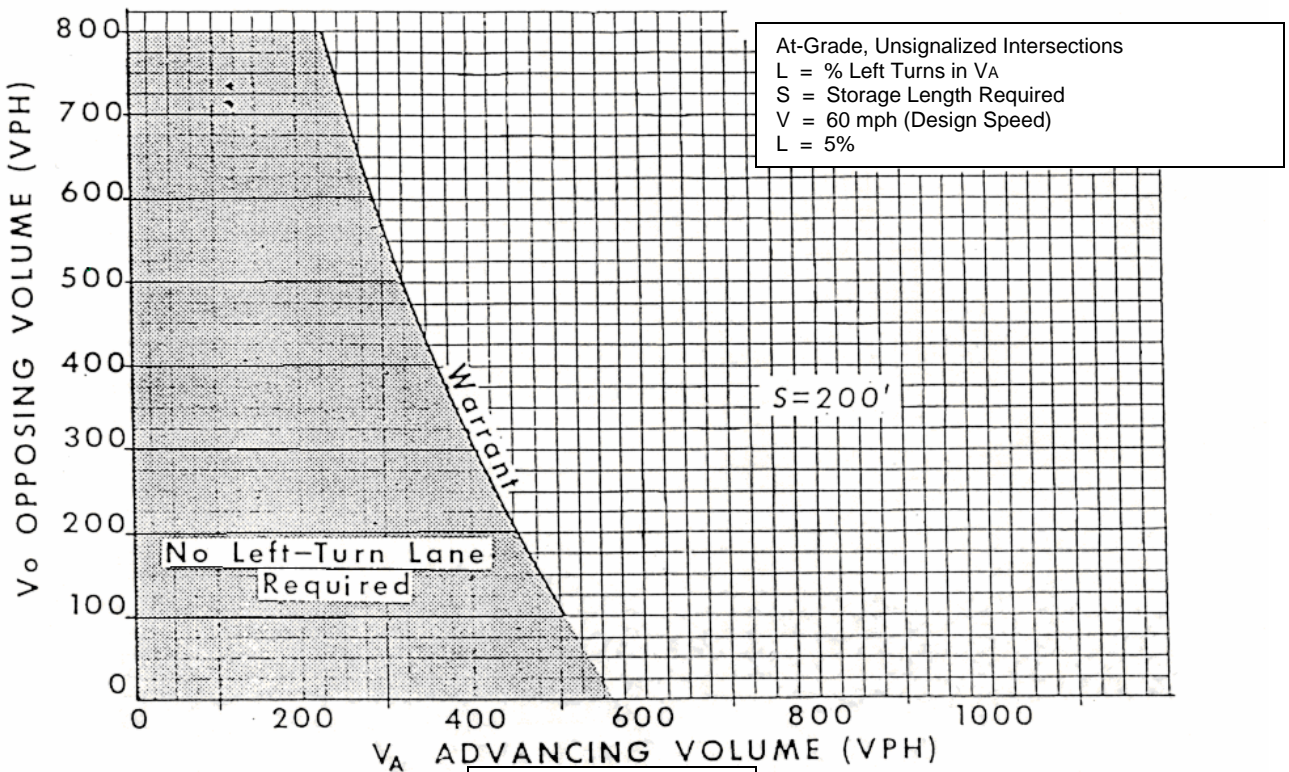

**FIGURE 3-14**

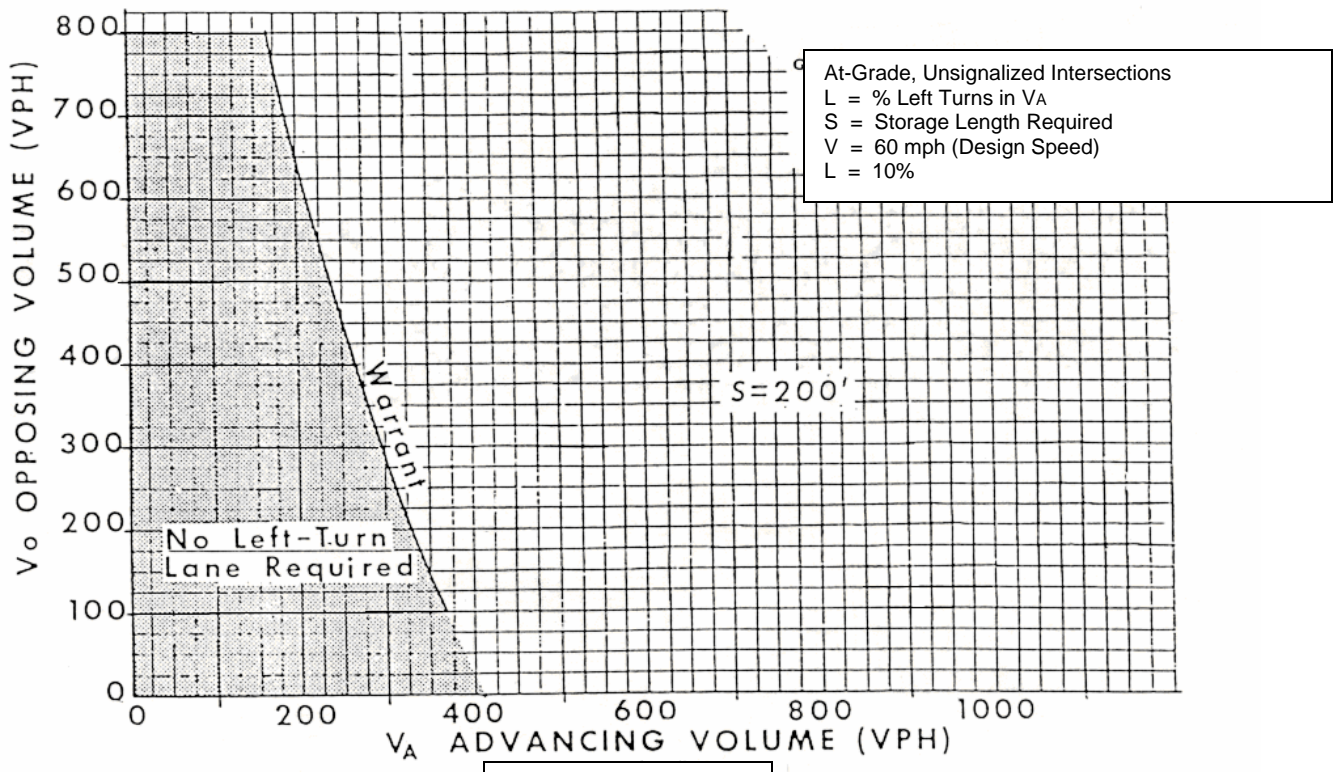

**FIGURE 3-15**

### WARRANT FOR LEFT-TURN STORAGE LANES ON TWO-LANE HIGHWAYS

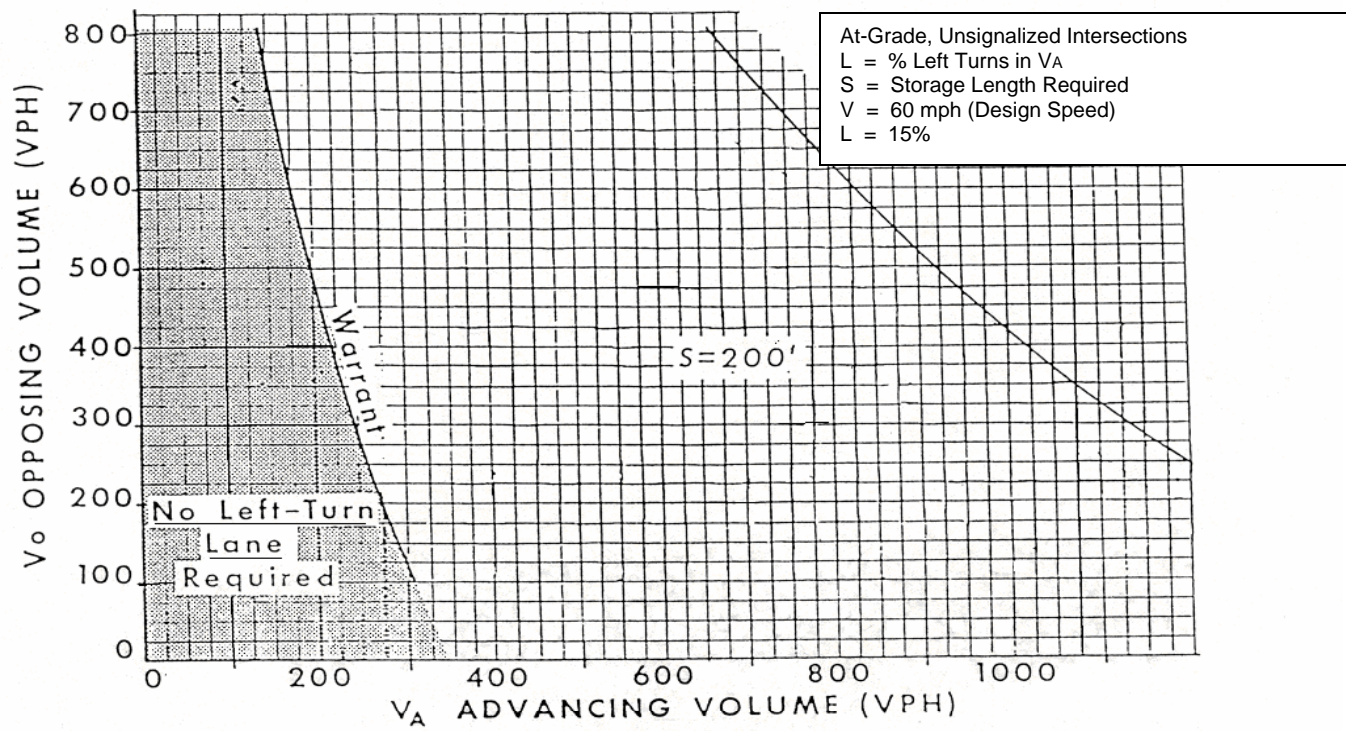

**FIGURE 3-16**

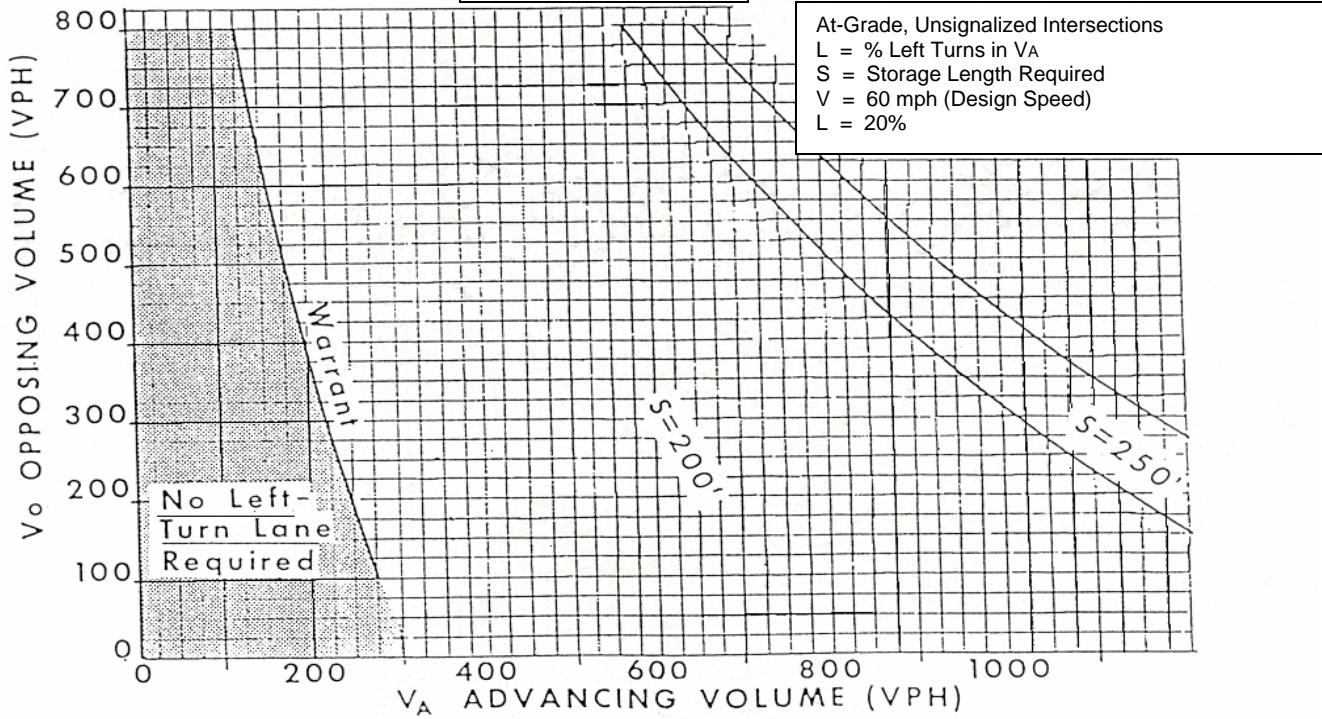

**FIGURE 3-17**

### WARRANT FOR LEFT-TURN STORAGE LANES ON TWO-LANE HIGHWAYS

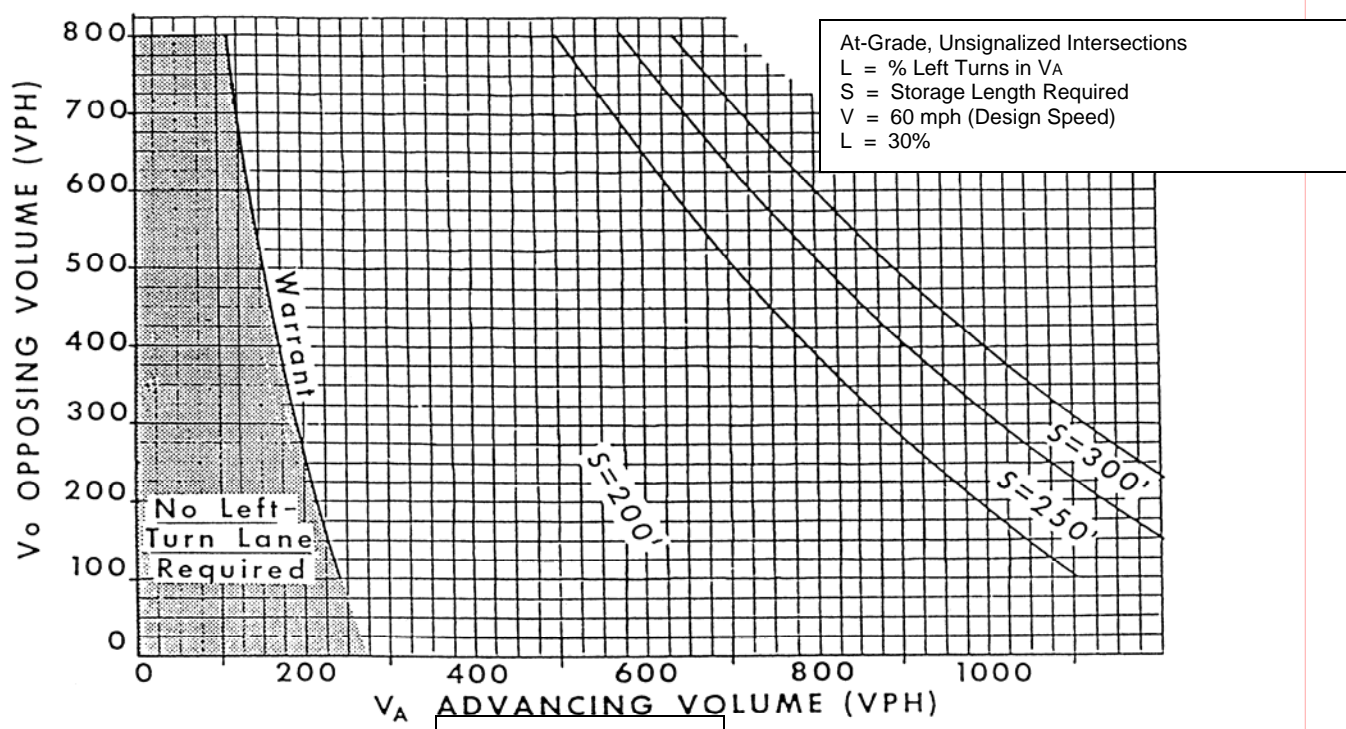

**FIGURE 3-18**

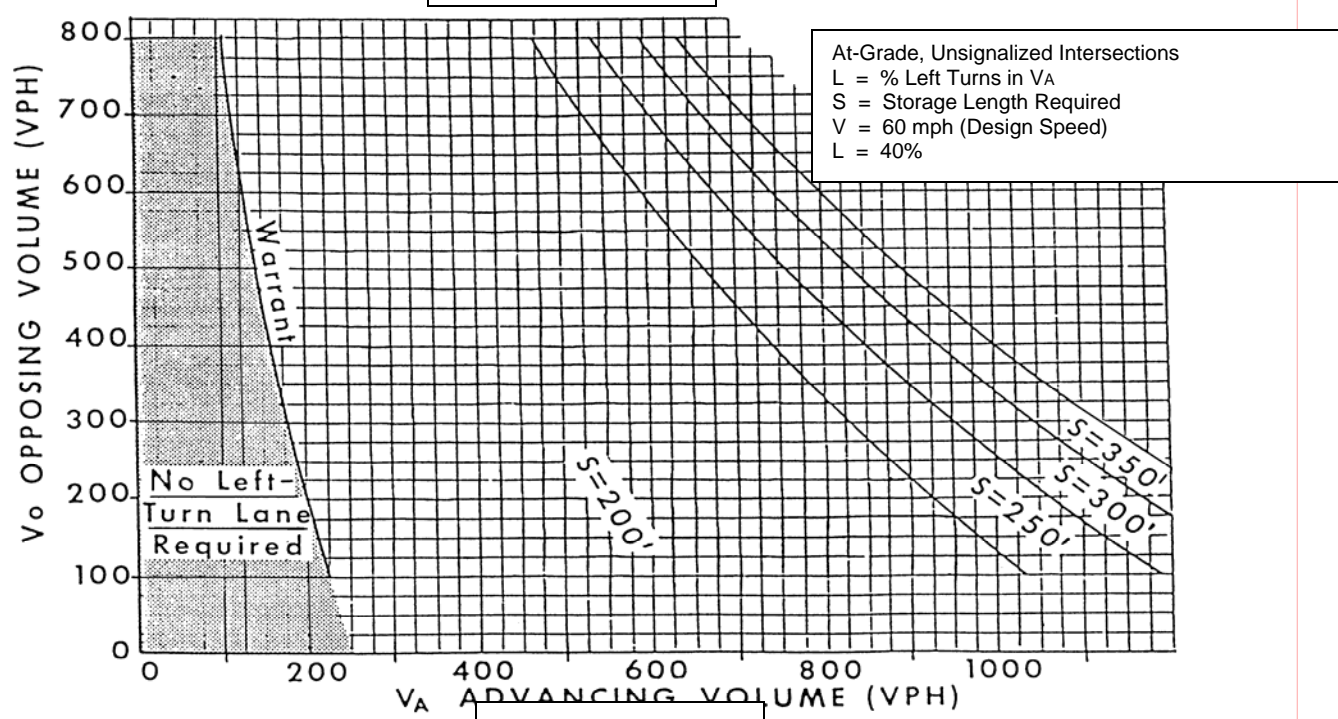

**FIGURE 3-19**

### WARRANT FOR LEFT-TURN STORAGE LANES ON TWO-LANE HIGHWAYS



**FIGURE 3-20**



**FIGURE 3-21**

## Medians

Channelization: Positive channelization should be provided for all median openings. Standard striping in accordance with the Manual on Uniform Traffic Control Devices (MUTCD) should be used for all openings and speed change lanes in medians without raised channelization. Medians with raised channelization require mountable curbing on the nose section and the mountable curb should be marked with yellow paint containing retro-reflective glass beads. If new curbing is required in addition to the nose sections, it should match the existing curb type of the median. Median openings on rural, high-speed highways should be signed with Do Not Enter and One-way) signs.

U-turns: The median width may be designed to permit U-turn movements. If a facility is too narrow to safely permit a U-turn, these movements should be addressed in design (such as flare outs on page 19) or restricted through signage. Sign use and placement require Department approval.

Pavement: Median paving should be full depth and match the pavement section design of the existing roadway.

Drainage Function: Medians frequently provide a conveyance, detention or retention function for roadways. The installation of a median opening should not reduce the conveyance or storage capacity of the median.

### Directional Median Opening for Left Turns and U-Turns

A directional median opening for left turns and U-turns limits movements at median openings to specific turns only; the physical design actively discourages or prevents all other movements.

- The technique can be applied to unsignalized median openings on multilane divided urban and suburban streets.

### Special Considerations

- The minimum width of a median nose has commonly been 4 feet. AASTHO recommends a minimum median width of not less than 4 feet and 6 to 8 feet wide is preferable where pedestrians may be present.
- Narrow median noses are difficult to see especially at night and in inclement weather. Reflectorized paint is of little help as it rapidly becomes dirty and loses its limited reflectivity. Reflectorized traffic buttons or reflectorized pylons help but lack the mass necessary to provide good target value.
- Carefully selected landscaping is the most effective way to ensure high visibility of the median and median openings.

- Landscaping of the median nose for visibility is especially important where long left-turn lanes are used. The choice of vegetation and the landscaping design must ensure that sight distance is not obstructed.
- Overlapping of the separators of a directional median opening restricts movements to the intended left turn or U-turn.
- Directional median openings will accommodate U-turns by automobiles where the separation is at least 4 feet wide and there are three opposing lanes. Where there are two opposing lanes a triangular flare of 10 feet along the intersecting roadways and at least 20 feet along the major roadways will allow an automobile to execute a U-turn.

#### Advantages

- The directional median opening for left turns and U-turns improves safety by limiting the number and location of conflict points and by prohibiting direct crossing.
- Right-angle crashes are avoided because vehicles are prevented from crossing where the median width is not sufficient for drivers to cross one-traffic stream at a time.

#### Disadvantages

- Cross-median movements are limited to specific locations and to specific turns.
- It is not practical to design for U-turns executed by large vehicles in all directions.



### Illustration of Directional Median Opening for Left Turns and U-Turns

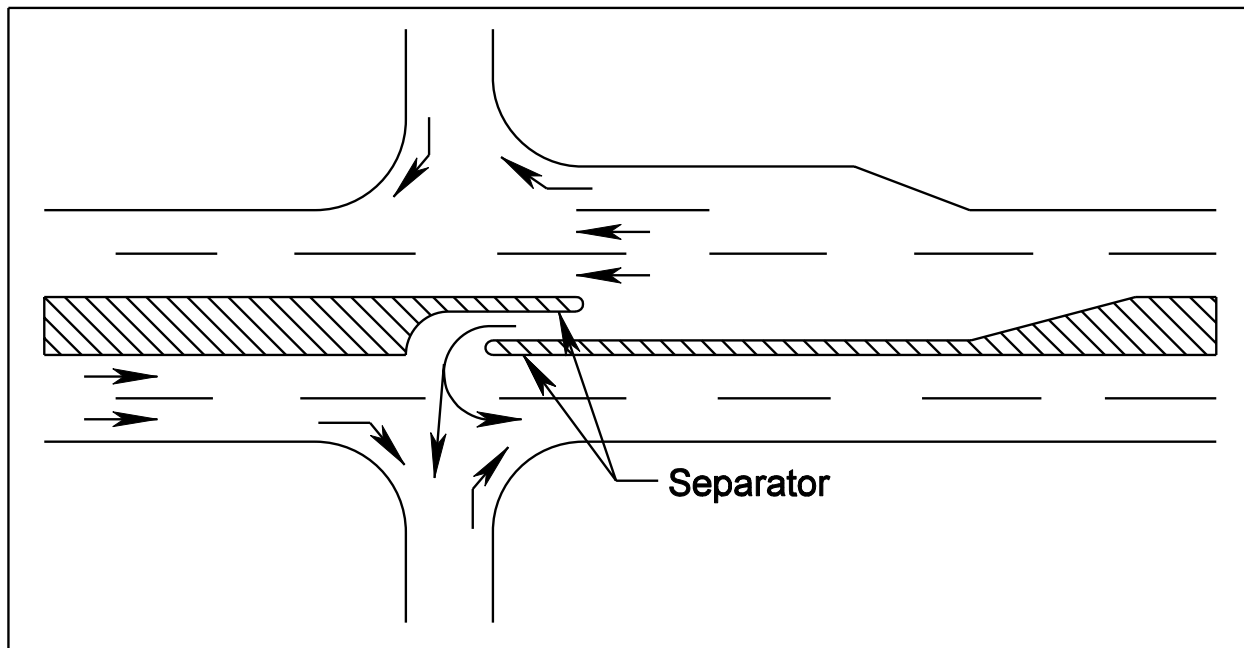

**FIGURE 3-22**

Source: TRB, Access Management Manual, Dated 2003

#### Examples

- Some states make extensive use of directional median openings. Preference is given to left turns and U-turns from the major roadway. Existing full median openings are reconstructed as directional openings as part of resurfacing projects or reconstruction projects. The minimum width of 2 feet can be accommodated in the standard 16 foot raised median. Separators are overlapped by at least 2 feet.
- The Michigan DOT has pioneered a variation of the directional median opening called the Michigan U—Turn. This design involves the installation of directional openings near signalized intersections.

## Right Turn Lanes

An exclusive right-turn lane should be considered when the warrants on page 55 and 56 are met. Double exclusive right-turn lanes may be provided when capacity analysis warrants. Safety implications associated with pedestrians and bicyclists should always be considered.

These guidelines are to be used as an aid in selecting appropriate treatments for right turn movements. (Reference material attained from Virginia Highway and Transportation Research Council report "The Development of Criteria For the Treatment of Right Turn Movements on Rural Roads" dated March 1981).

1. Number of Lanes - Guidelines are differentiated on the basis of the number of lanes on the major roadway. The minor roadway is a 2-lane road. Discussion on both figures is provided. All volumes refer to the volumes on the approach under consideration for right turn treatments.
2. Radius Treatment – Refer to guidelines for right turn treatment on 2-lane roadways. The predominant treatment for 2-lane roadways is the radius. Arterial roadways tend to carry higher volumes of traffic traveling at higher speeds as compared to local roadways.

The traffic on local roadways tends to include a higher number and percentage of right-turning vehicles than that on arterials. An adjustment is needed to permit local roadways to handle more right turns (at lower speeds) compared to arterial roads. The following adjustment is made for posted speeds at or under 45 mph.

Adjusted Number of Right Turns = Number of Right Turns - 20 for number right turns > 40 and total volume < 300

For example, Total volume = 200 vph, Right turn volume = 70 vph and Posted speed = 40 mph. Then adjusted number of right turns -  $r = 70 - 20 = 50$ . Therefore, projecting a total volume 200 vph and  $r=50$  vph in the table, a radius is recommended for the right turn treatment.

3. Four-lane roadways tend to have a taper or full-width lane to facilitate right turn movements. Many of these roads are divided highways with a speed limit of 55 mph.
4. Curb Channelized Island should be considered to separate right turn lanes from thru traffic based on capacity analysis.

5. Other factors - The selection of a treatment for right turn movements may be influenced by sight distance, availability of right of way, grade, and angle of turn. Although these factors are not incorporated in the guidelines, they should be given consideration. The guidelines should be used unless the Engineer at the District or Residency determines that special treatment is necessary due to other factors.
6. Data collection procedures - In order to employ these guidelines, peak hour volume data must be provided.

**Right / Left Turn Lanes may be required beyond these guidelines at the discretion of the District Administrator or designee.**

Conditions for providing an exclusive right turn lane when the right turn traffic volume projections don't exceed the guidelines:

- Facilities having a high volume of buses, trucks or trailers.
- Poor internal site design of a driveway facility causing potential backups in the through lanes.
- Heavier than normal peak flows on the main roadway.
- Very high operating speeds (such as 55 mph or above) and in rural locations where turns are not expected by through drivers.
- Highways with curves or hills where sight distance is impacted.
- Higher functionally classified highways shall be considered so that the impact of turning movements on highways intended to serve through traffic is minimized.

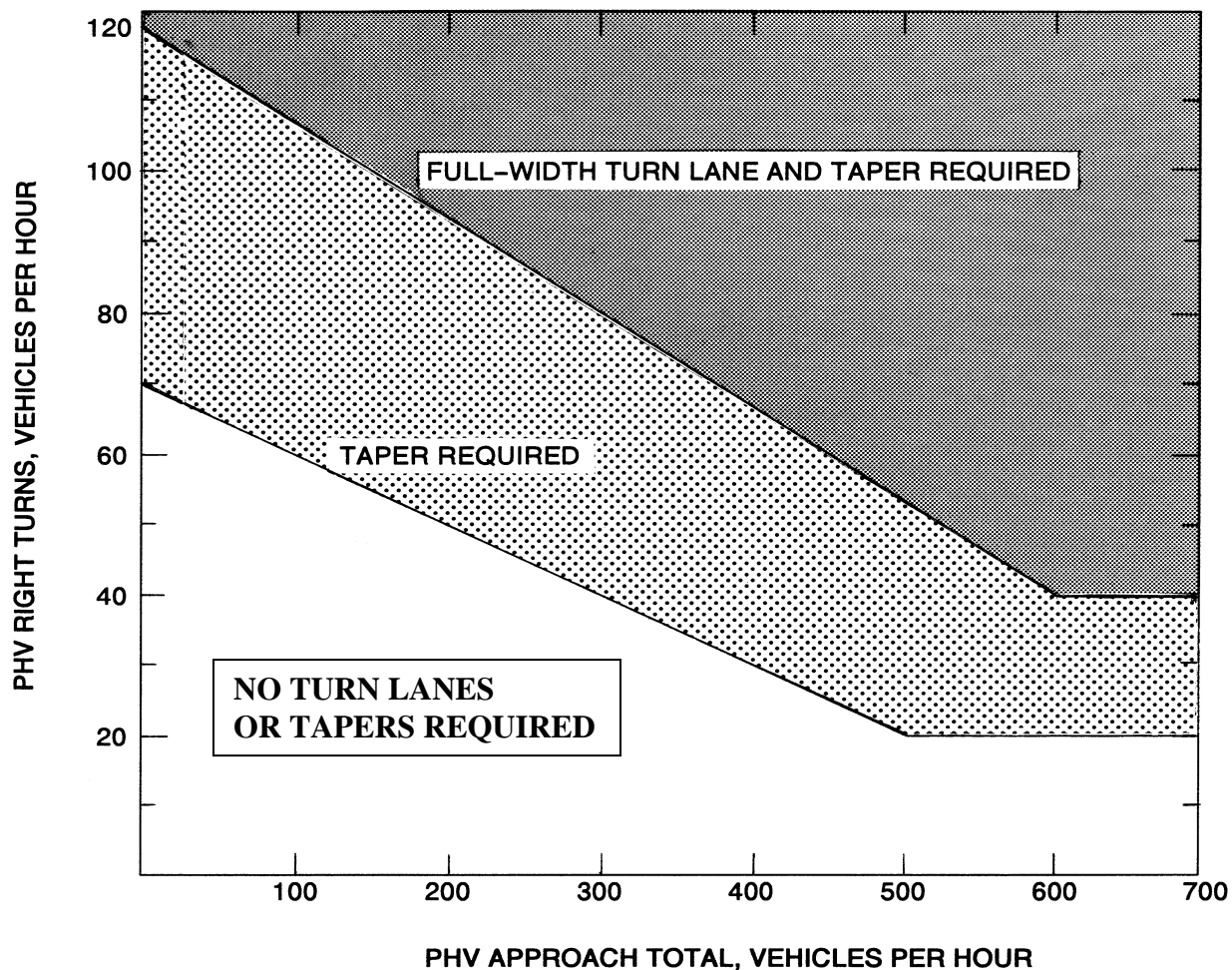

Appropriate Radius required at all Intersections and Entrances (Commercial or Private).

### LEGEND

**PHV** - Peak Hour Volume (also Design Hourly Volume equivalent)

#### Adjustment for Right Turns

For posted speeds at or under 45 mph, PHV right turns > 40, and PHV total < 300.

Adjusted right turns = PHV Right Turns - 20

If PHV is not known use formula:  $PHV = ADT \times K \times D$

K = the percent of AADT occurring in the peak hour

D = the percent of traffic in the peak direction of flow

Note: An average of 11% for K x D will suffice.

**FIGURE 3-23 GUIDELINES FOR RIGHT TURN TREATMENT (2-LANE HIGHWAY)**

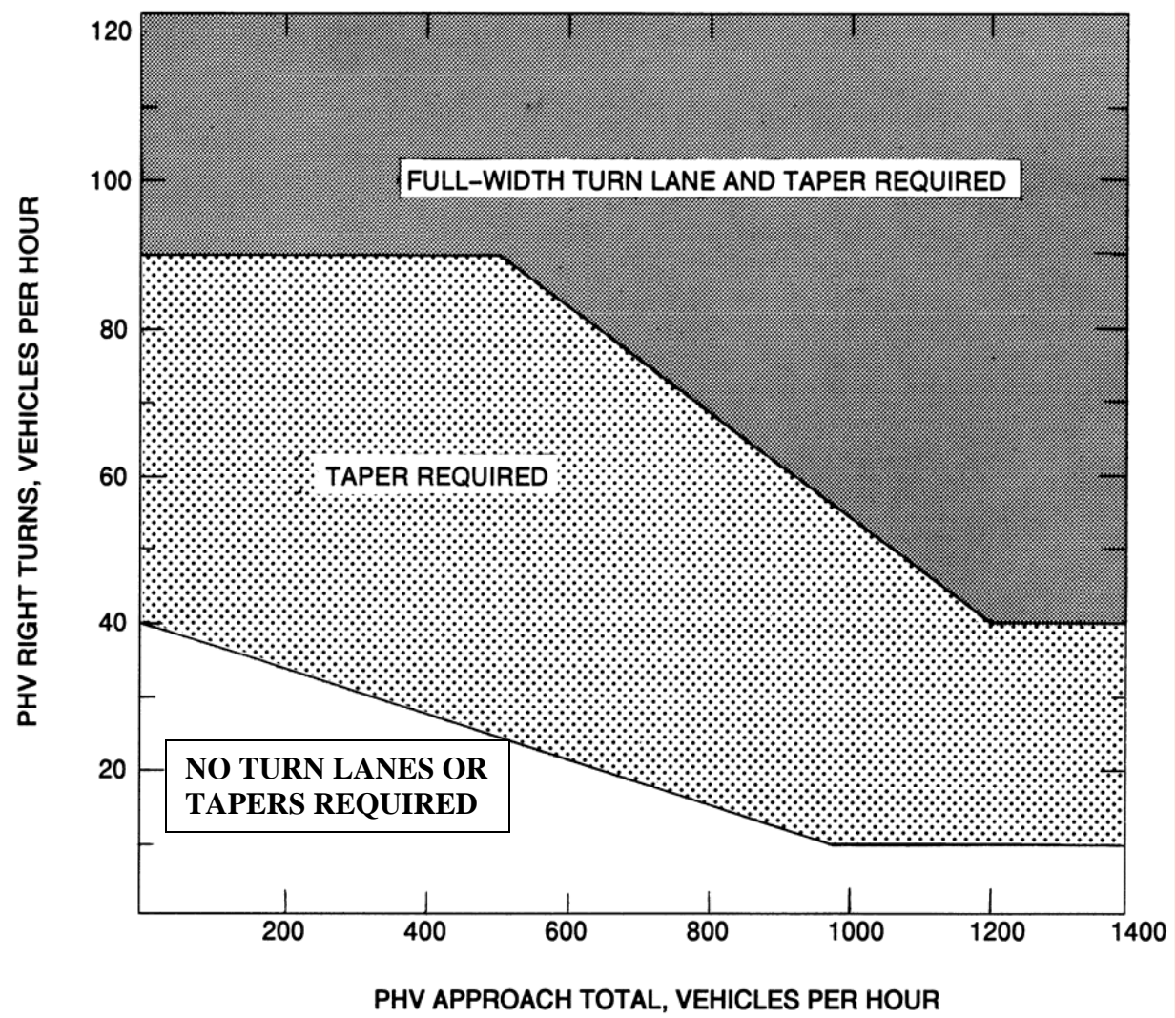

Appropriate Radius required at all Intersections and Entrances (Commercial or Private).

**LEGEND**

**PHV**- - Peak Hour Volume (also Design Hourly Volume equivalent)

**Adjustment for Right Turns**

If PHV is not known use formula:  $PHV = ADT \times K \times D$   
K = the percent of AADT occurring in the peak hour  
D = the percent of traffic in the peak direction of flow  
Note: An average of 11% for K x D will suffice.

**FIGURE 3- 24 GUIDELINES FOR RIGHT TURN TREATMENT (4-LANE HIGHWAY)**

**Acceleration Lanes**

Acceleration lanes should consist of a full-width lane and a transition taper. Acceleration lanes should be designed so that a turning vehicle will reach a speed between 75 and 80 percent of the highway posted speed at the point where the full-width lane ends and transition taper begins.

- **Acceleration Lane:** A stop condition should be assumed when determining the length of an acceleration lane for an at-grade access. The length of an acceleration lane is the same for a right-turn acceleration lane or for a left-turn acceleration lane.
- **Transition Taper:** Acceleration tapers should be straight line tapers with rounded beginning and ending points.

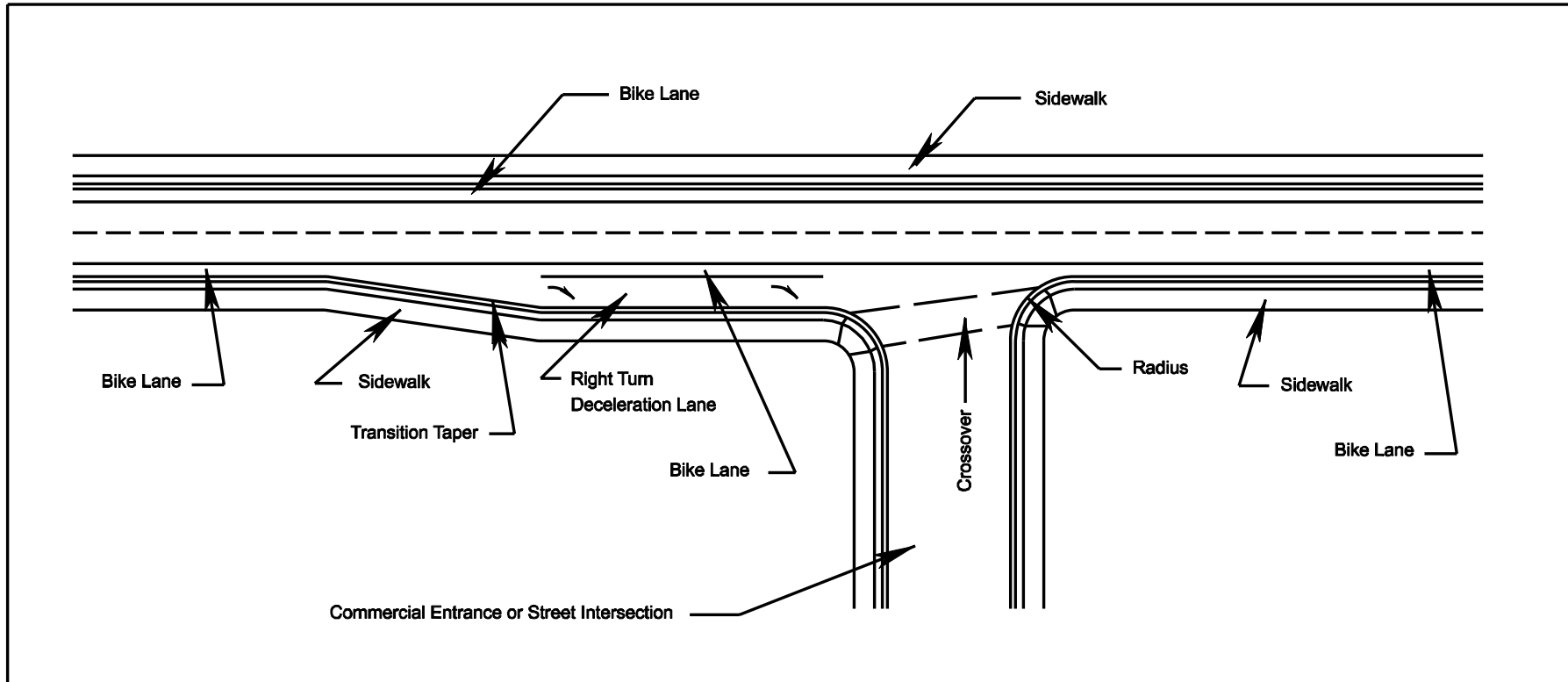

**FIGURE 3-25 TYPICAL APPLICATION WITH SIDEWALKS AND BIKE LANES WITH RIGHT-TURN DECELERATION LANES (CURB AND GUTTER SECTION)**

Note: All entrance design and construction shall accommodate pedestrian and bicycle users of the highway in accordance with the Commonwealth Transportation Board's "Policy for Integrating Bicycle and Pedestrian Accommodations".

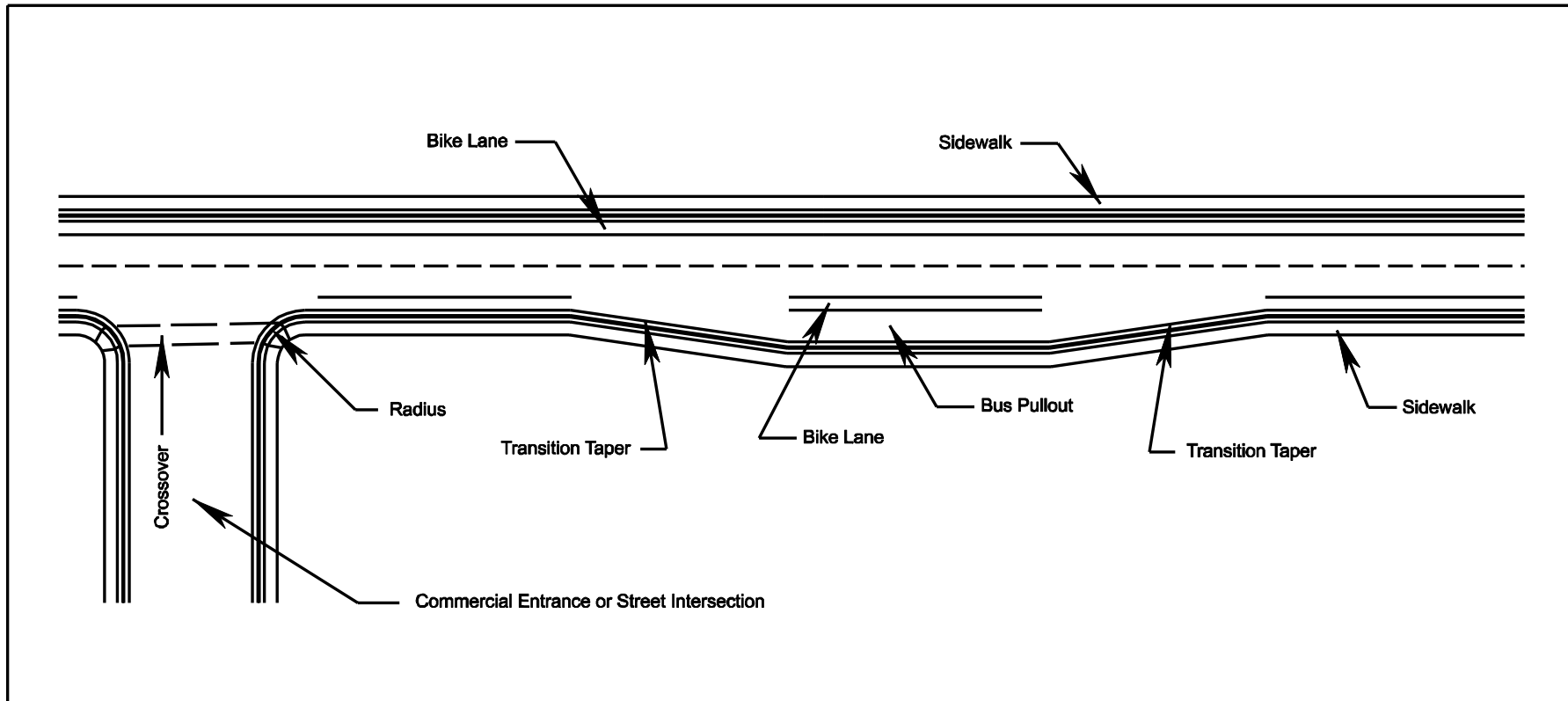

**FIGURE 3- 26 TYPICAL APPLICATION OF A BUS PULLOUT**

Note: All entrance design and construction shall accommodate pedestrian and bicycle users of the highway in accordance with the Commonwealth Transportation Board's "Policy for Integrating Bicycle and Pedestrian Accommodations".



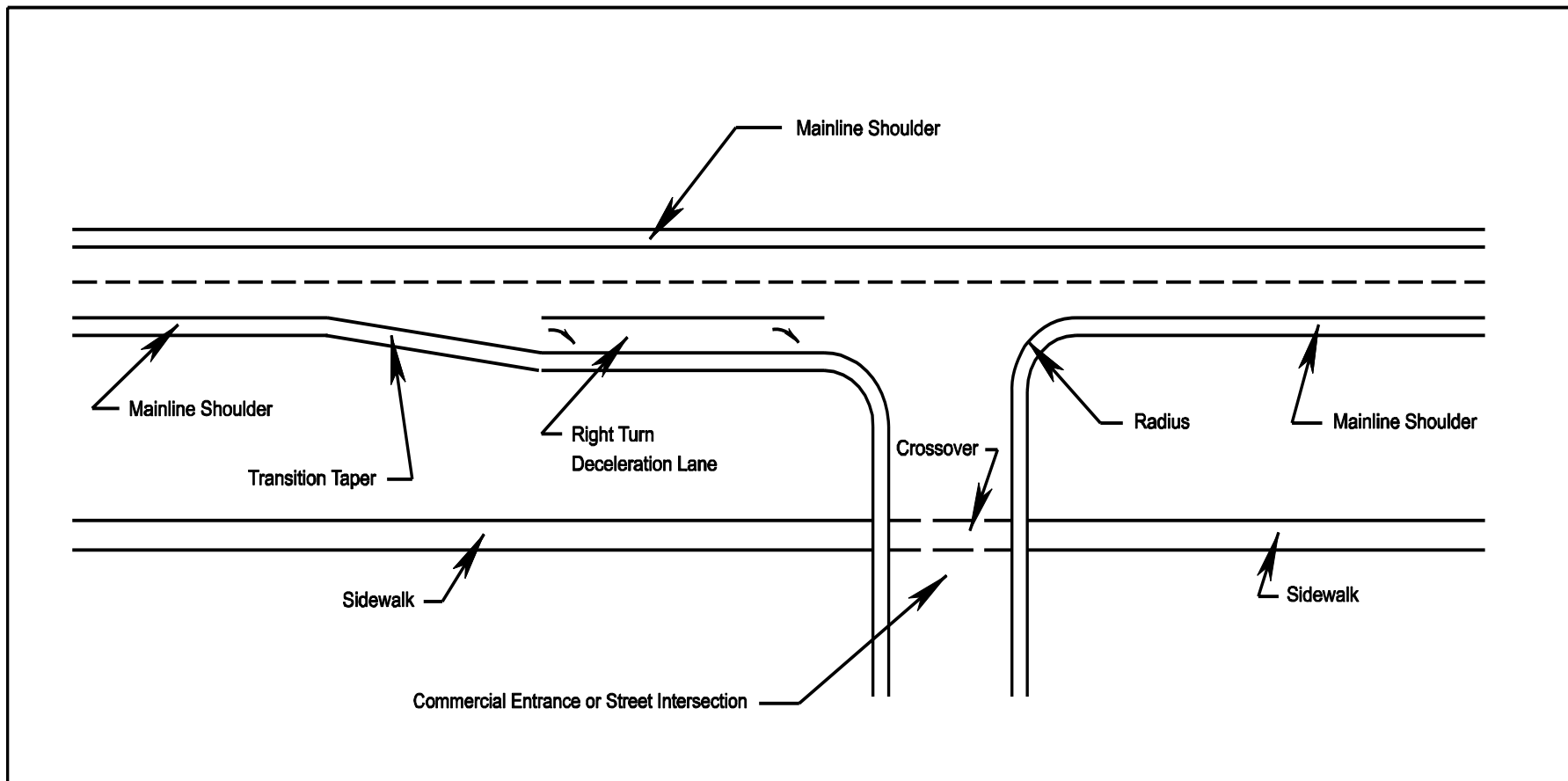

**FIGURE 3-27 TYPICAL APPLICATION OF A RIGHT-TURN DECELERATION LANE (SHOULDER SECTION)**

Note: All entrance design and construction shall accommodate pedestrian and bicycle users of the highway in accordance with the Commonwealth Transportation Board's "Policy for Integrating Bicycle and Pedestrian Accommodations".

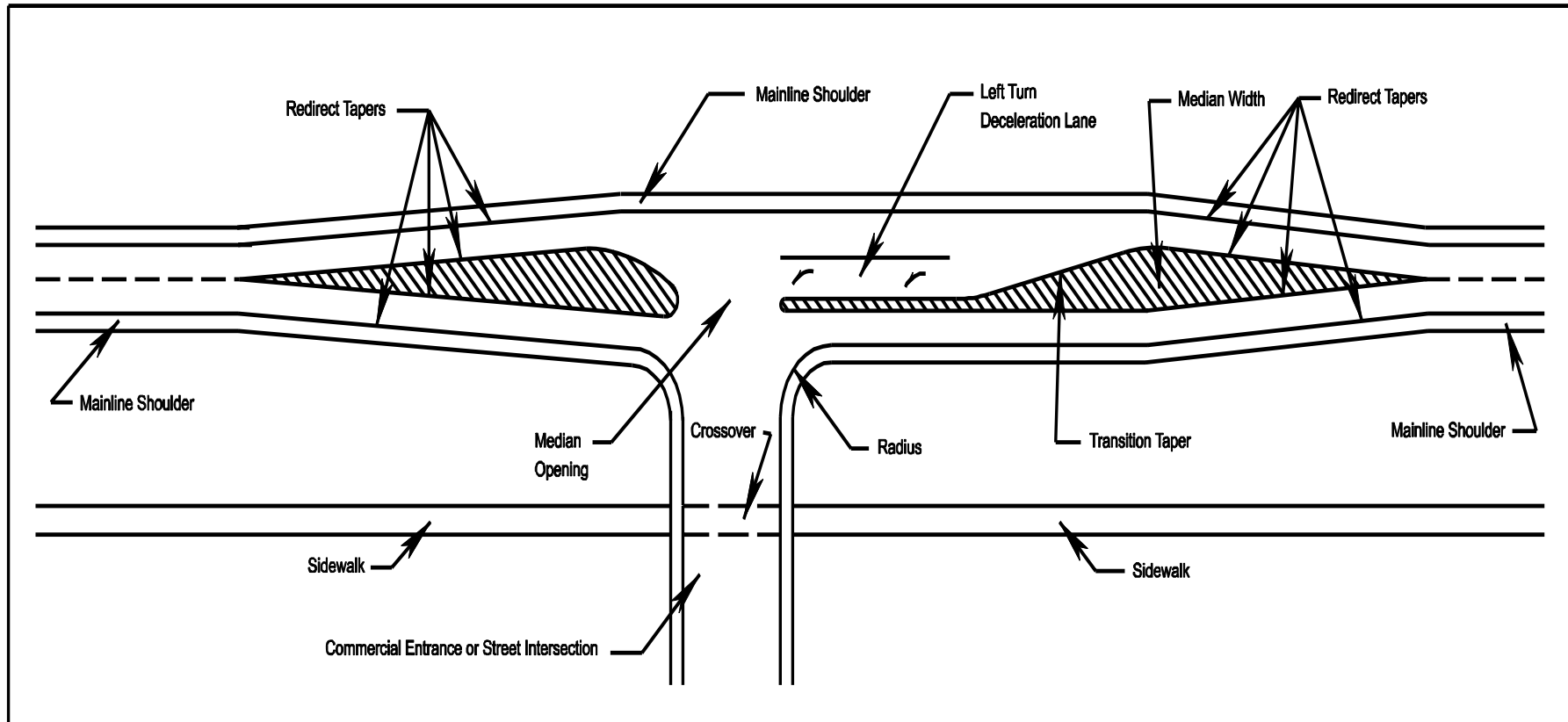

**FIGURE 3-28 TYPICAL APPLICATION OF A LEFT-TURN DECELERATION LANE (SHOULDER SECTION)**

Note: All entrance design and construction shall accommodate pedestrian and bicycle users of the highway in accordance with the Commonwealth Transportation Board's "Policy for Integrating Bicycle and Pedestrian Accommodations".

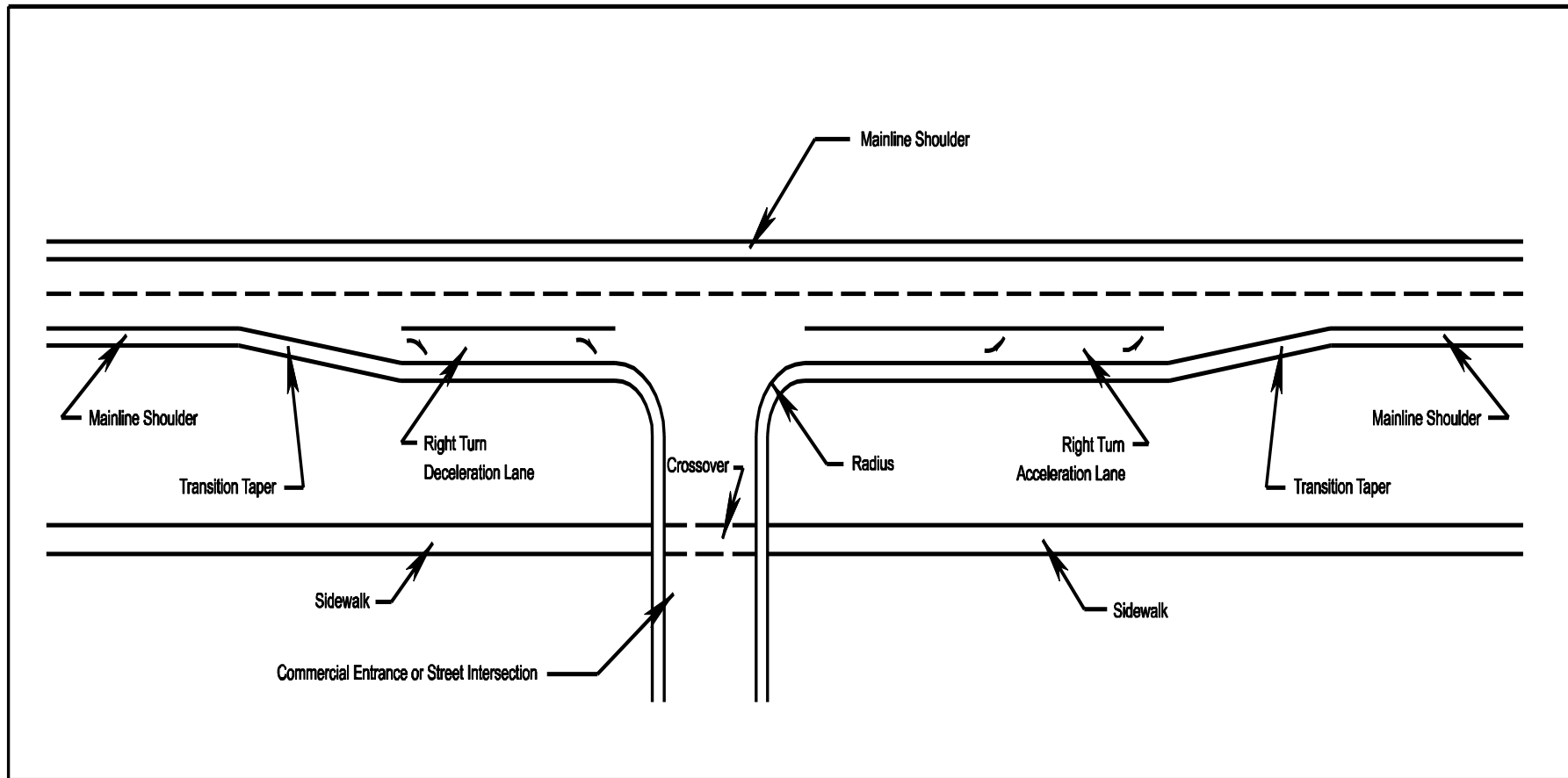

**FIGURE 3- 29 TYPICAL APPLICATION OF A RIGHT-TURN ACCELERATION AND DECELERATION LANE  
(SHOULDER SECTION)**

Note: All entrance design and construction shall accommodate pedestrian and bicycle users of the highway in accordance with the Commonwealth Transportation Board's "Policy for Integrating Bicycle and Pedestrian Accommodations".

## SECTION 4 – ENTRANCE DESIGN

### Entrance Design Principles

Entrances are, in effect, at-grade intersections and should be designed consistent with the intended use. The number of crashes is disproportionately higher at entrances than at other intersections; thus their design and location merit special considerations. Entrances should not be situated within the functional area of an intersection or in the influence area of an adjacent entrance. The functional area extends both upstream and downstream from the physical intersection area and includes the longitudinal limits of auxiliary lanes.

**Entrance Angle:** The entrance centerline should be perpendicular to the state highway centerline and extend tangentially for a minimum distance of 40 feet beyond the near-side edge line. An acute angle between 60 degrees and 90 degrees may be permitted if significant physical constraints exist. Acute angles less than 60 degrees shall require special approval of the Department.

**Entrance Radius:** The entrance radius should be designed to accommodate the design vehicle expected to use the entrance on a daily basis.

<b>Design Vehicle and Turning Radius by Land Use</b>		
<b>Land Use(s) Served by Access</b>	<b>Design Vehicle</b>	<b>Radius</b>
Residential	Passenger Car/Pickup	24
Residential on Bus Route	Single Unit Truck (Bus)	45
Office with Separate Truck Access	Passenger Car/Pickup	24
Office without Truck Access	Single Unit Truck	42
Commercial / Retail with Separate Truck Access	Passenger Car/Pickup	24
Commercial / Retail without Separate Truck Access	WB-50 Truck	45
Industrial with Separate Truck Access	Passenger Car/Pickup	24
Industrial without Separate Truck Access	WB-50 Truck	45
Recreational without Watercraft Access or Camping	Passenger Car/Pickup	24
Recreational with Watercraft Access or Camping	Motor Home/Boat	50
Agricultural Field Access	Single Unit Truck	42
Municipal and County Roads	WB-50 Truck	45

**TABLE 4-1**

Note: “with separate Truck Access” indicates truck prohibition from primary access

Entrance into mixed use developments will use designed to accommodate the largest design vehicle expected to use that entrance.

## Private Entrances (Existing State Highways)

1. Curb and gutter private entrances  
At all entrances, standard entrance gutter (Std. CG-9A, CG-9B, and CG-9D) shall be used with Standard CG-6 or CG-7 curb and gutter. A special design entrance gutter shall be submitted for approval when roll top curb is used.
  
2. Ditch section private entrances  
All private entrances shall be designed to serve no more than two individual lots. All private entrances should be designed and constructed as shown in Figure 4-1. Entrance radius shall be 20' minimum. All entrance pipe culverts will be sized to accommodate the run-off expected from a 10-year frequency storm.  
  
All entrance grades shall start back of the shoulder line. If drainage is necessary, the ditch line may be moved back to provide cover for pipe. Entrances shall be at least 12' wide and shall be tied into the roadway smoothly. The entrance surface shall extend from the edge of the roadway to the right of way line. The entrance surface can be crusher run aggregate or paved.
  
3. Entrance grades  
In the interest of assuring an adequate, convenient, and safe access to public roads, VDOT recommends the grades along entrances not exceed 10%.

## Private Entrance Detail

### Notes:

See VDOT Road and Bridge Standards, PE-1 for cut/fill details.

All entrance grades shall start back of the shoulder line.

If drainage is necessary, the ditch line may be moved back to provide 9 inches (min.) cover over pipe.

Entrances shall be a minimum 12 ft. wide and transition smoothly into the roadway surface. Entrance pavement shall extend to the right of way line. When an existing street is re-developed and modification of an existing entrance is required, the entrance pavement shall be extended to the right of way line or the extent of disturbance to the existing entrance.

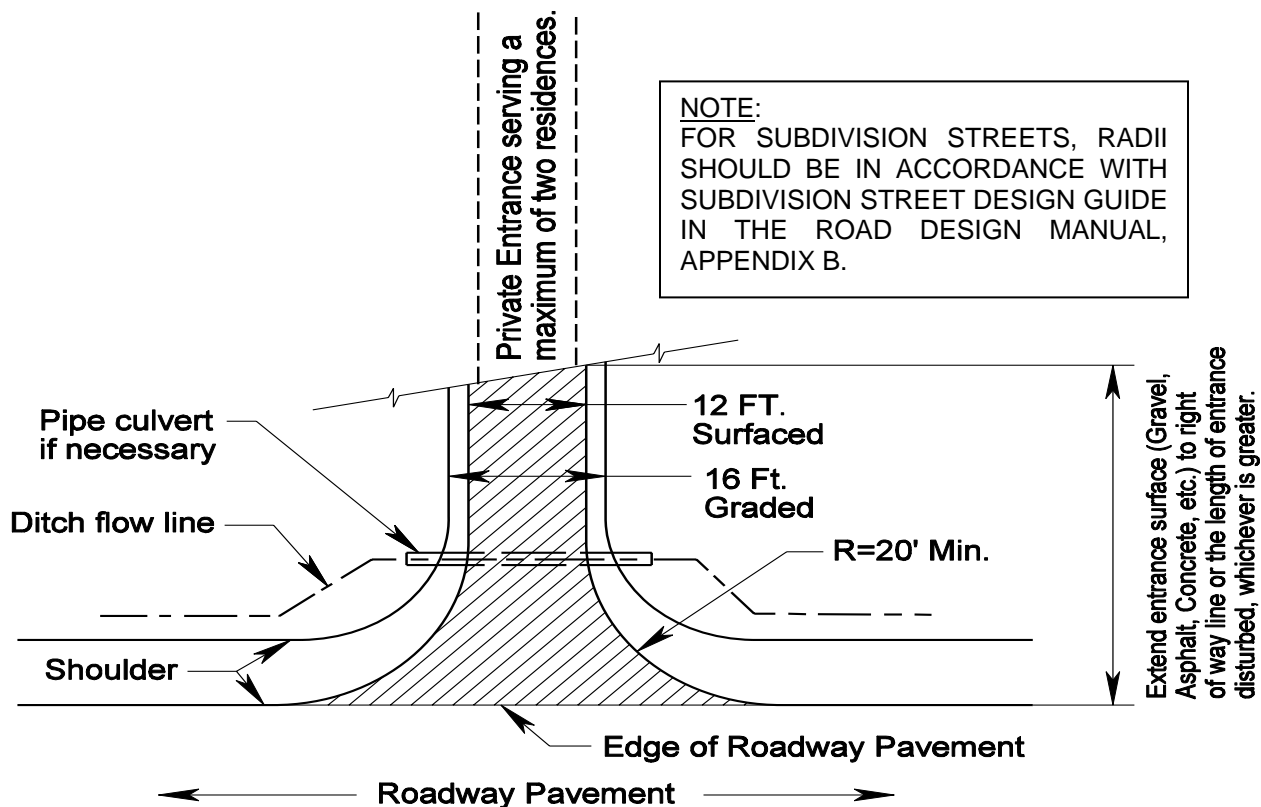

FIGURE 4-1

### Commercial Entrances

All commercial entrances should be designed to promote safe and efficient movement of vehicles in the entrance and on state highways.

An access shall not be approved for parking areas that require backing maneuvers within state highway right of way. All off-street parking areas must include on-site maneuvering areas and aisles to permit vehicles to enter and exit the site in forward drive without hesitation.

**Entrance Medians:** Entrance medians should be used when two or more lanes are required for both the entering and the exiting movements at the entrance or when an estimated daily traffic volume of 2,000 vehicles per day is expected to use the entrance.

- (a) Entrance medians shall have a minimum width of 4 feet.
- (b) All curbing within the highway clear zone shall be in accordance with VDOT's Road and Bridge Standards, or as approved by the District Administrator or designee, and appropriate for the operational speeds of the facility. Non-regulatory signs shall not be placed in the portion of an entrance median located within the right of way, or within the highway clear zone, and shall not restrict intersection sight distances.

- (c) An entrance median should not contain structures, signs, or landscaping which restrict sight distance. The minimum size of a driveway median island is 100 square feet.

**Entrance Throat:** The entrance throat should be designed to facilitate the movement of vehicles off the highway to prevent the queuing of vehicles on the traveled way. Minimum connection throats are provided in the table below.

Entrance throats apply to entrances to commercial uses, corner clearance (Pg. 71) establishes the “Throat” of a minor street intersecting a major street.

<b>Summary of Entrance Throats</b>	
Number of Egress Lanes (left, thru and right)	Minimum Throat Length
	Feet
1	30
2	75
3	200
4	300

**TABLE 4-2**

Source: Transportation & Land Development 2<sup>nd</sup> Edition 2003, Koepke and Stover

In order to assure that entrances are designed to provide for safe and efficient movements, it is necessary to pay attention to critical dimensions and design features listed below.

- Radius of curved approach/exit of entrance
- Flare size of angled approach/exit of entrance
- Entrance Distance or spacing between entrances
- Corner Clearance measured from a major intersection.
- Angle of entrance
- Sight distance length of roadway visible to the driver required for vehicles to make safe movements
- Entrance location in relation to other traffic features such as intersections, neighboring entrances, and median openings.
- Entrance depth (also called “throat length”) distance needed into site to transition vehicles to the internal circulation system of the site.
- Right turn lanes separate through and turning traffic on roadways to facilitate right turns into the entrance.

**Entrance Pavement:** The type and depth of the pavement shall be clearly indicated on the plans and/or permit application. The pavement of entrances, turn lanes and tapers shall be of stable material that is at least comparable to the pavement of the adjacent roadway.

Access Vertical Alignment: The vertical alignment of all access locations should be designed to minimize vehicle bounce and prevent high-centering of vehicles with a maximum clearance of 4 inches. The maximum grade for an entrance should be 8% for all commercial entrances. Steeper access entrances require District Administrators approval. A level area (maximum 2% grade) 20 feet in length should be provided at each access to ensure proper sight distance from the access, The level area is measured from the highway edge of pavement or from the back of sidewalk, whichever is appropriate based on site-specific conditions.

Entrance Cuts: The maximum vertical curve, crest or sag, shall have a maximum 4-inch vertical offset over a 10-foot chord length. A standard vertical curve should be designed for all driveway profiles that exceed 3.3%.

Entrance Drainage: Drainage shall be considered in the design of entrance grades. Roadways and curb-and-gutter sections that convey storm water runoff within the roadway prism should be designed in accordance with department standards site runoff into state right of way should be minimized.

Width - All commercial entrances shall have a width sufficient for the particular land use and anticipated traffic flow with a minimum width of 16 feet for a one-way drive and 30 feet for a two-way drive. The maximum width should be 20 feet for a one-way drive and 40 feet for a two-way drive. These widths should be measured at right angles to the centerline of the driveway at the right of way line. Entrances with multiple lanes or median may require additional width. For subdivision streets, radii width and angle should be in accordance with Subdivision Street Design Guide in the Road Design Manual, Appendix B.

Radii - All commercial entrances should have radii large enough to accommodate the largest design vehicle that will use it without creating undue congestion or hazard on the through highway (See Table on page 63). The minimum entrance radius allowed should be 25 feet and the minimum exit radius allowed should be 25 feet. For subdivision streets, radii width and angle should be in accordance with Subdivision Street Design Guide in the Road Design Manual, Appendix B.

Tapers, Deceleration Lanes, and Passing Lanes - When a commercial establishment will generate high traffic volumes, deceleration tapers, turning lanes and acceleration lanes may be required.

Angled Entrances - When the property owner desires to construct dual commercial driveways at other than 90 degrees to the centerline of the road, an entrance on the right side as approaching should not have less than a 60 degree angle with the centerline of the road.

Profile - All commercial entrances should be built to a sidewalk elevation at the right-of-way line. Beyond the right of way line, the grade should not exceed 8 percent. Entrance configurations are shown beginning on page 78.



### Commercial Entrance Location Criteria

Entrances shall be placed at locations that provide adequate intersection sight distance. These locations often occur at the top or bottom of inclines. In hilly areas, proper locations can be at a premium, and shared access might be necessary.

Entrances shall not be placed within the functional area of any intersection. Greater spacing may be required due to stacking requirements of the approaches to the intersection. This can be particularly evident around signalized intersections.

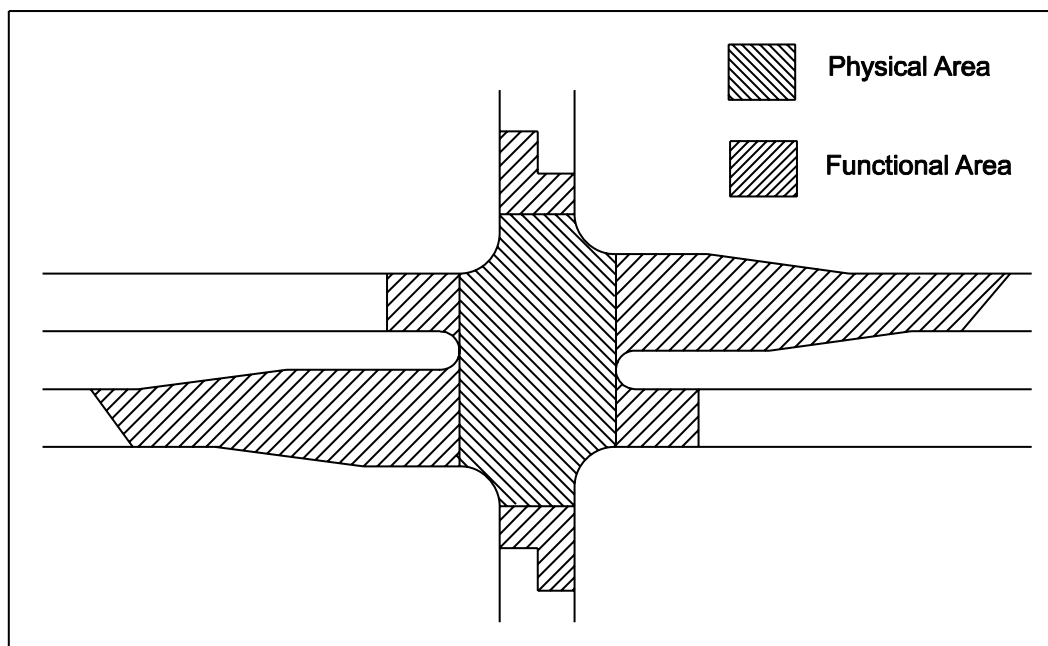

**FIGURE 4-2**

Source: FHWA, NHI Course No. 15255

AASHTO specifically states that “a driveway should not be located within the functional boundary of an intersection”. AASHTO does not present guidelines as to the size of the functional area of an intersection; however the size must be much larger than the physical area (see Figure 4-2). The functional area should be composed of the distance traveled during the braking Perception-Reaction Time plus the distance required to move laterally and come to a stop plus any required storage length (see Figure 4-2A). The minimum maneuver distance assumes that the driver is in the proper lane and only needs to move laterally into a right turn or left turn bay.

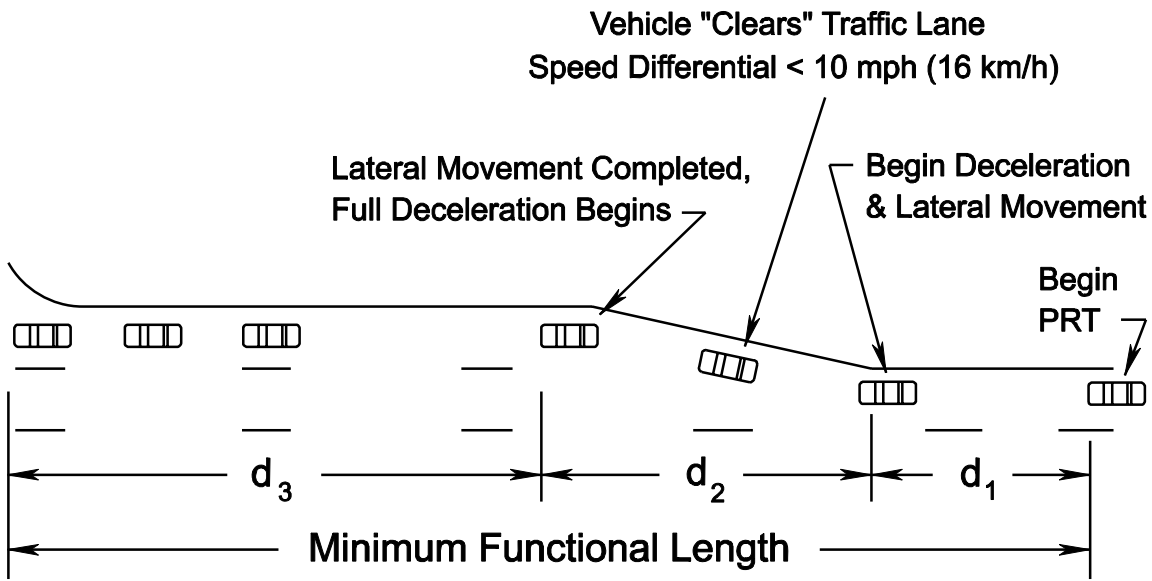

- $d_1$  = distance traveled during perception-reaction time (PRT) (0.6 sec. x Design Speed in ft/sec.)
- $d_2$  = distance traveled while driver decelerates and maneuvers laterally (Taper length see page 36)
- $d_3$  = storage length (See page 36)

FIGURE 4-2A

## Commercial Entrance Sight Distance

Entrances shall be located to provide adequate intersection sight distance. Minimum intersection sight distance criteria are provided below. The line of sight establishes the boundary of a sight triangle within which there should be no sight obstruction. At any location where the sight line leaves the right of way, a permanent easement must be maintained and the area must be graded and landscaped such that sight distance is not compromised, for a commercial entrance to be approved, (For an Appeals Process See Regulation 24 VAC. 30-72-50).

Offsets: Improvements on public or private property adjacent to the right of way should be located so that parking, stopping, and maneuvering of vehicles within the highway right-of-way will not occur. The minimum distance from the right of way line for all structures and sight obstructions should be the clear zone. At all entrances and intersections, an adequate sight triangle shall be provided. The minimum setback point for the sight triangle should be 14.5 feet from the near-side extended highway edge of pavement.

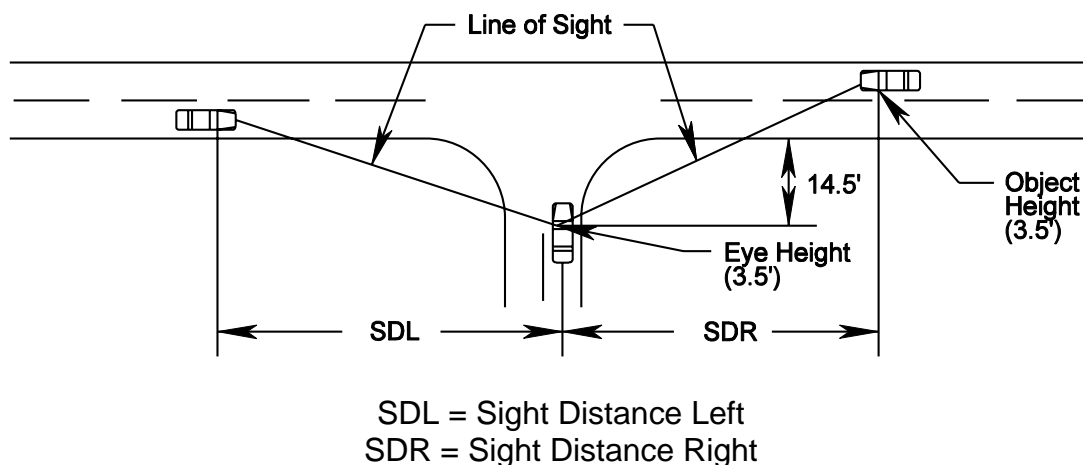

All site plans for proposed developments shall show the location of all proposed and existing entrances within the area of the proposed development. The location of all of the proposed entrances shall be reviewed to determine if proper spacing will be maintained.

## **Commercial Entrance Spacing**

Access management increases the spacing between entrances, thus reducing the number and variety of events to which drivers along the corridor must respond. Close spacing between unsignalized entrances forces the driver to watch for ingress and egress traffic at several locations simultaneously. Increased spacing translates into fewer accidents, savings in travel time, and preservation of corridor capacity.

Entrances should be located to limit interference with the free movement of roadway traffic, and to provide the most favorable sight distance and driveway grade. No direct access entrance should be located in the operational area of a signalized intersection.

Entrance spacing shall be based on spacing standards in Table 2-2.

## **Corner Clearance Downstream on a Minor Side Street**

It is important to think of the operational impacts of entrance placement on side streets. The operational character of the traffic turning from the main street onto the side street as well as the expected queues on the side street, help determine how far downstream to place the closest side street entrance.

Achieving proper corner clearance involves regulating the distance between a crossroad intersection and the nearest entrance location. Corner clearance is defined as the distance, measured perpendicular to the major roadway, from the nearest edge of an entrance to the nearest edge of the major intersection (Inclusive of radii).

Moving the basic entrance conflict area away from the vicinity of an intersection can be accomplished by regulating the distance from the entrance to the intersection. The major effect is that vehicles will be delayed less by standing queues at signalized intersections.

In most instances, the minimum corner clearance will be governed by the intersection sight distance. Minimum entrance setbacks should be considered at individual intersections, and should be based on typical queue lengths that still allow sufficient movement to and from an entrance.

Similar to the placement of an entrance on the main roadway, conflicts for the existing vehicles for the side street entrance must be considered. For the right turn out (flow A) the vehicle approaching from the left (flow C) must be considered. The greater the radius (R) for right turning vehicles from the main roadway, the faster they will be approaching the side street driveway. For the driver exiting the side street driveway to go left (flow B), the length of the queue at the main intersection must be considered to assure there is enough room to turn left from the driveway, not being blocked by queue D. The minimum corner clearance is 225', which equals the intersection sight distance for 20 mph. Additional length will be required as directed by the Engineer at the District or Residency if the intersection is signalized or future signalization is anticipated.

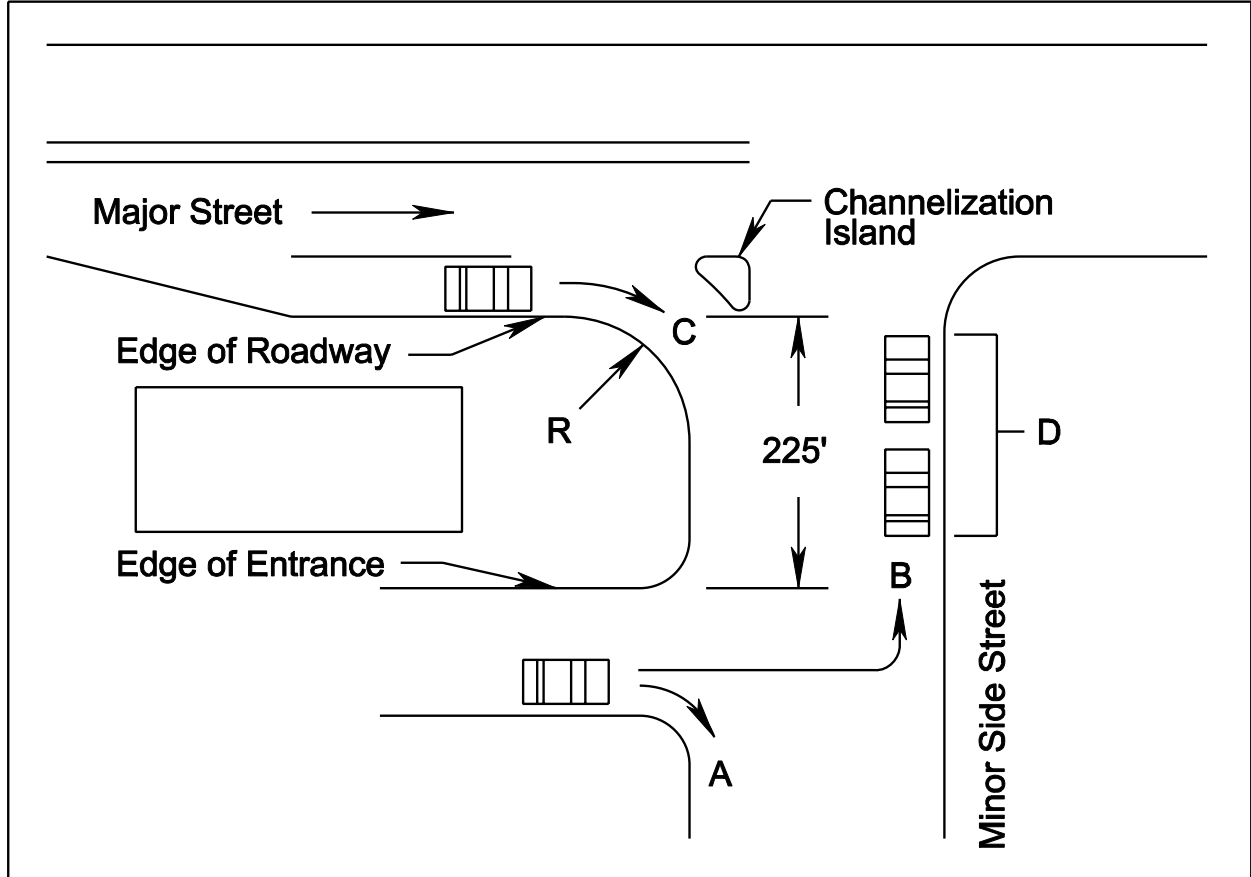

**FIGURE 4-3 DOWNSTREAM CORNER CLEARANCE**

### Commercial Entrance Channelization Island Options

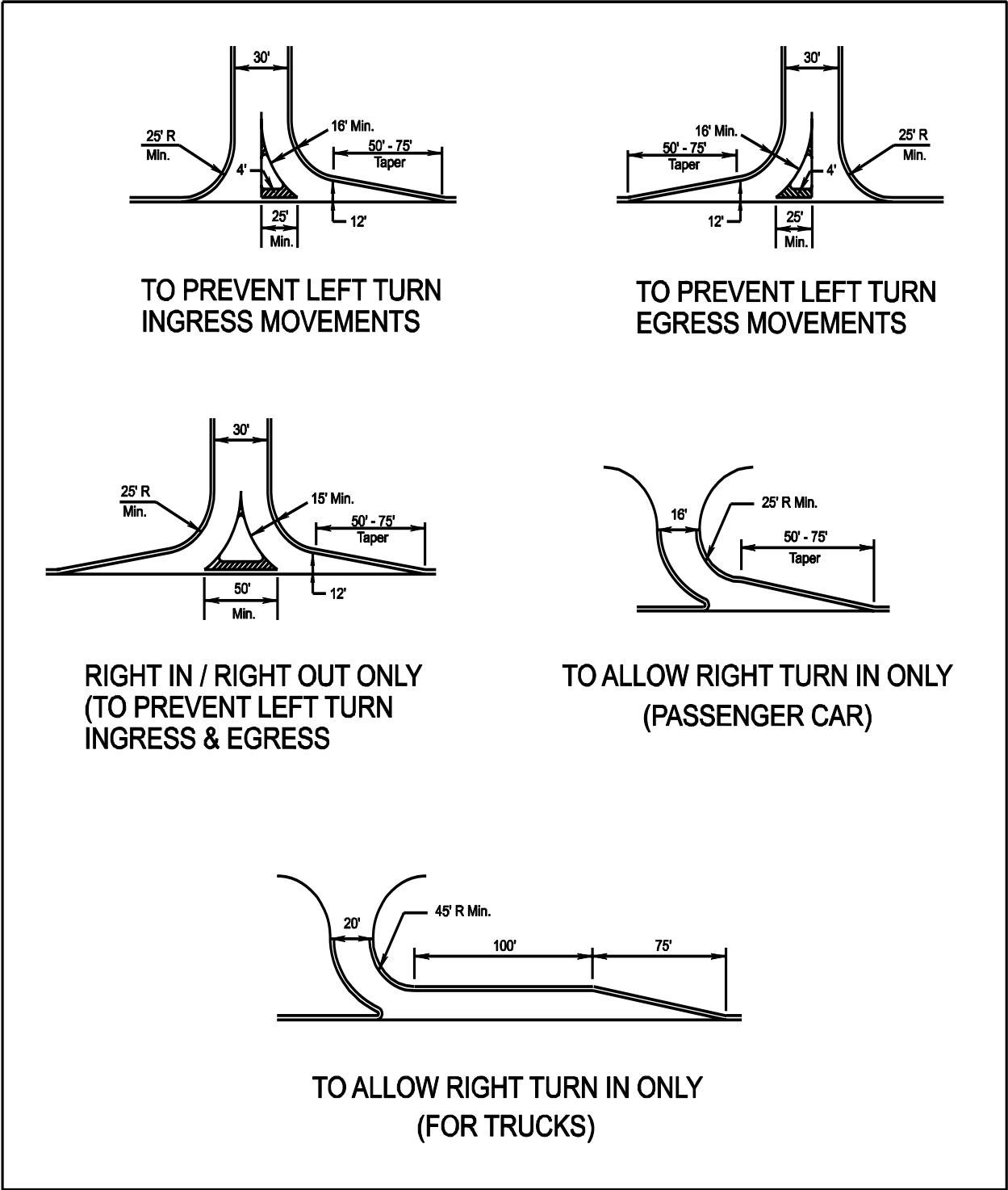

Source: Michigan DOT

**FIGURE 4-4 COMMERCIAL ENTRANCE CHANNELIZATION ISLAND OPTIONS**

### Entrance Connections on Opposite Sides of a Roadway

Closely spaced entrances on opposite sides of an undivided roadway or a roadway with two-way left-turn lanes (TWLTL) result in “jog” maneuvers, instead of separate and distinct left-turn and right-turn maneuvers (see below). They can also result in conflicting left-turns. Separation of the access connections results in their functioning as separate T-intersections (3-way intersection) that have relatively low crash potential.

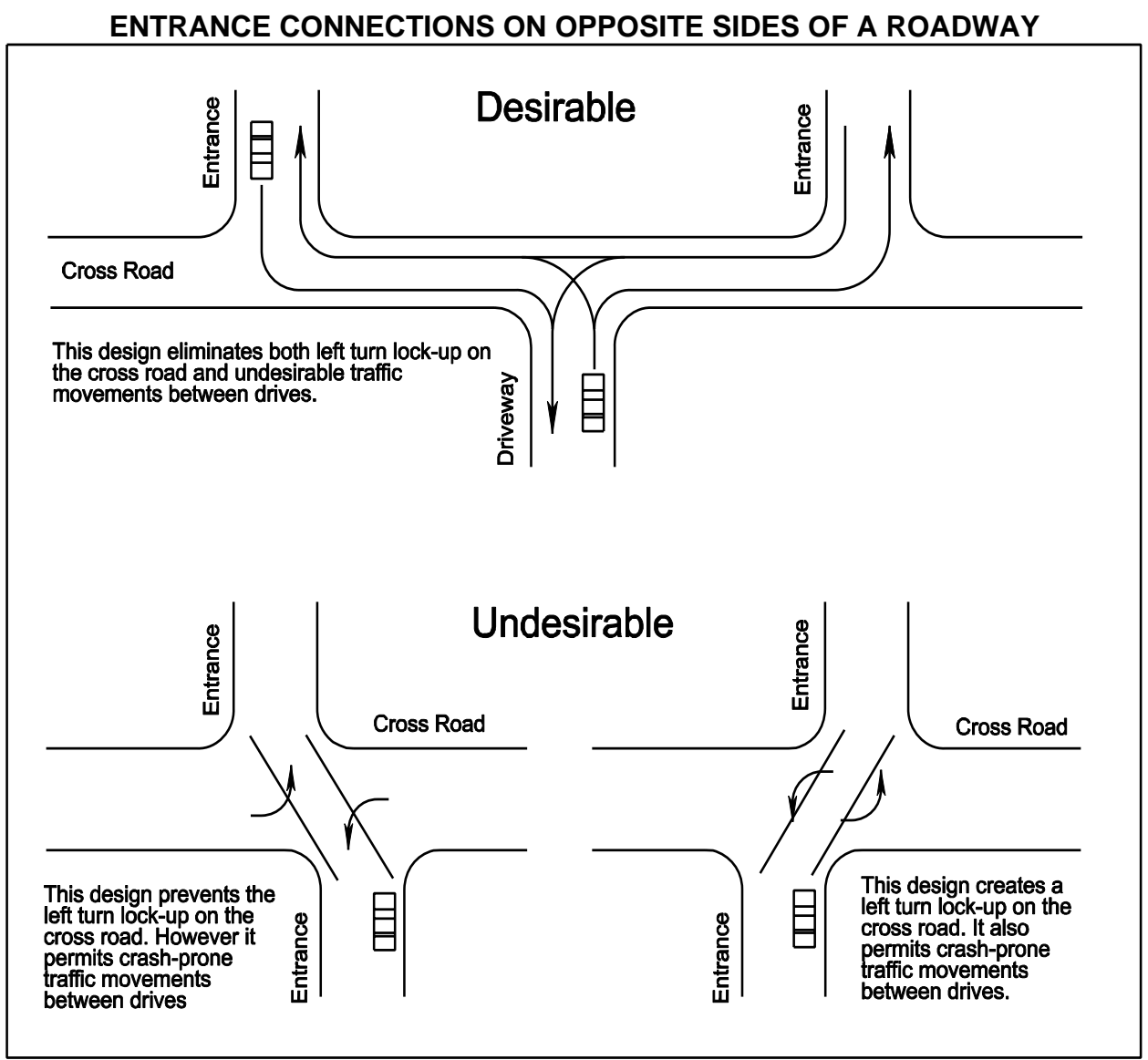

Source: FDOT- Driveway Handbook, Dated March, 2005

**FIGURE 4-5 ENTRANCE CONNECTIONS ON OPPOSITE SIDES OF A ROADWAY**

### **Entrance Consolidation (Shared Use Entrances)**

Shared Use Entrances are used to reduce the number of access points along a corridor while maintaining reasonable access to adjacent land uses. A Shared Use Entrance generally serves only two parcels.

A shared use entrance may be constructed if both property owners abutting a common property line agree. This encourages adjacent property owners to construct shared driveways in lieu of separate ones. Strategies for implementing this access control measure include closing existing driveways or authorizing joint-use ones. The feasibility of this measure should be viewed at the preliminary, site plan review and the permit-authorization stages. A shared access drive will result in a reduction in the concentration of driveways along a roadway, thus reducing the frequency and severity of conflicts.

The physical means by which access can be consolidated between two adjacent properties involves the construction of a joint-use driveway between the two properties. It is recommended that both property owners own the shared access drive. That is, the driveway should straddle the property line dividing the two establishments. The resulting joint-use parking area should be accompanied by an efficient internal circulation plan.

### **Shared Entrances and Internal Site Interconnection**

If a group of smaller developments share access, the driver needing to turn left across heavy volumes can usually find an access that is signalized, allowing safer left turns. Having good cross parcel access also maximizes the number of well designed unsignalized entrances that have good visibility and are located in such a way to take advantage of sufficient gaps in traffic from a nearby signal. Joint entrances and cross access especially help the small corner lots and out parcels. On small corner parcels left turn accessibility may be a problem and access to parcels may be limited to right in/right out or similarly restricted movements.



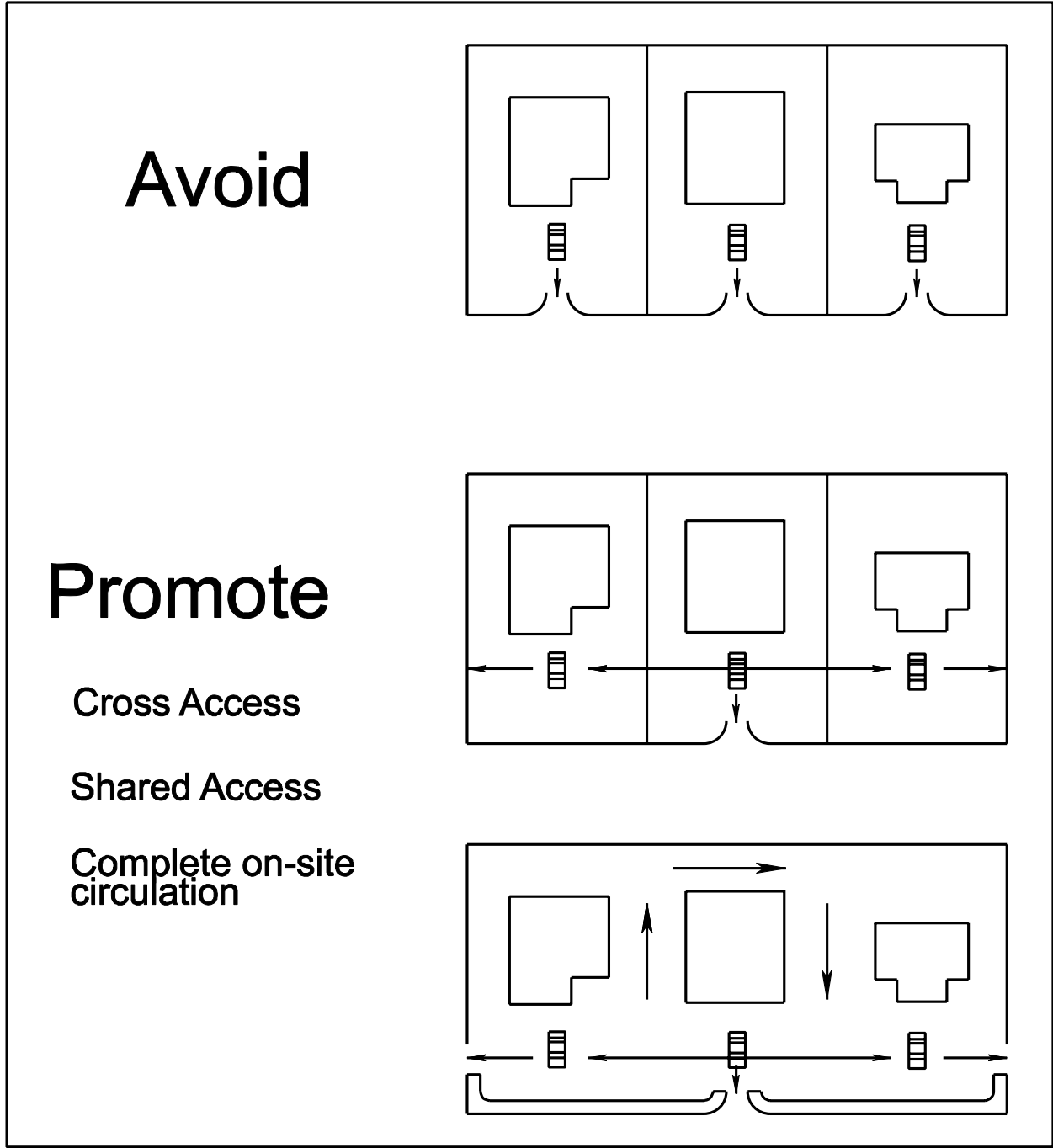

Source: FDOT- Driveway Handbook, Dated March, 2005

FIGURE 4-6

## Frontage Roads

Frontage or service roads may be constructed by VDOT where justified by existing or anticipated traffic needs, right of way requirements, etc. within funds available.

Where frontage or service roads have not been constructed by VDOT, the Department may cooperate with others in the construction of service roads to promote highway safety and provide suitable locations for public utility services.

VDOT may furnish assistance if the construction of a frontage road will provide significant public service and eliminate undesirable ingress and egress through the establishment of safe and properly spaced access points.

Frontage roads constructed in cities, municipalities, or towns of more than 3,500 or along Primary routes in those counties which maintain their Secondary roads shall meet all minimum VDOT standards or the standards of the city, town or county as provided by ordinance, whichever is stricter.

When frontage or service roads are constructed by someone other than VDOT, the following conditions shall apply:

<b>If the road is Constructed on...</b>	<b>Then the construction or use must...</b>	<b>And...</b>
Existing State Right of Way	Conform to such rules regulations, standards, specifications, and plans as may be approved by VDOT and authorized by issue of a permit	The cost of the construction is fully borne by others.
Land Outside Existing State Right of Way	Conform to such rules, regulations, standards, specifications, and plans, as may be approved by VDOT	The land must be dedicated to public use if the road is to be accepted into the highway system and maintained by VDOT.

Note: VDOT will accept as a part of the appropriate highway system, those service roads constructed by others in accordance with above criteria.

VDOT will maintain the roads in accordance with maintenance standards established for such classes of roads.

The cost of maintaining frontage roads shall be charged to the route and section of mainline highway which it serves unless it forms an integral section of another route.

Source: Code of Virginia, 15.2-2265 and 33.1-61

### Limits of Maintenance Responsibility for Private and Commercial Entrances

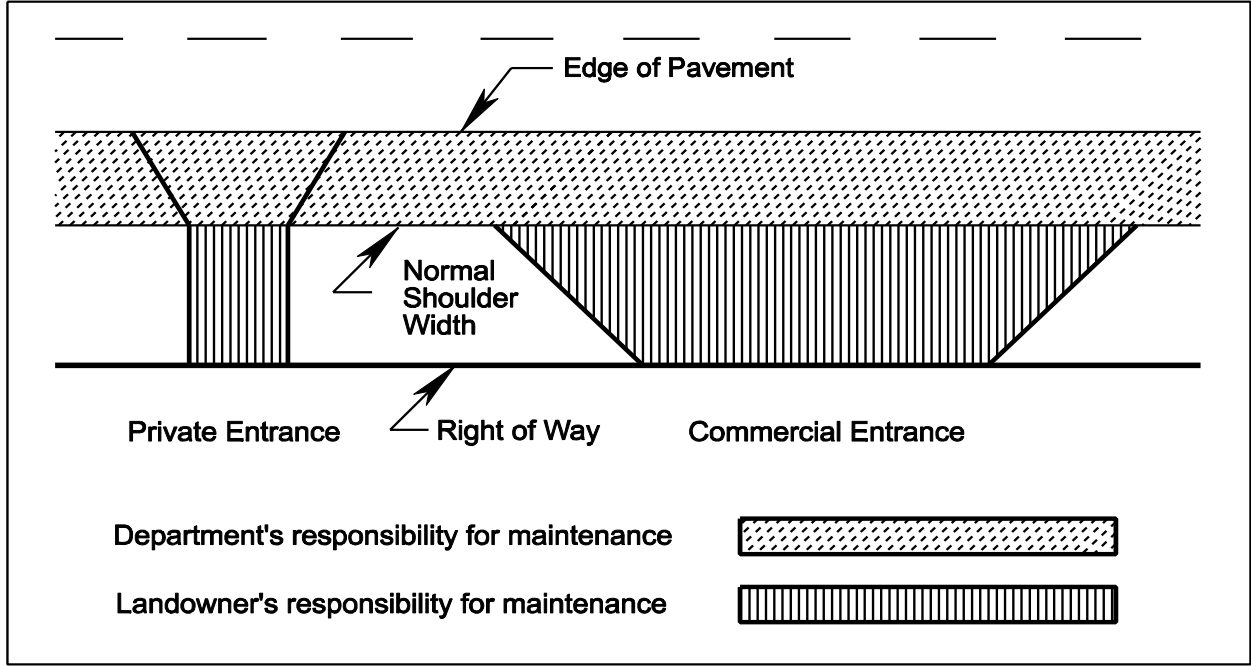
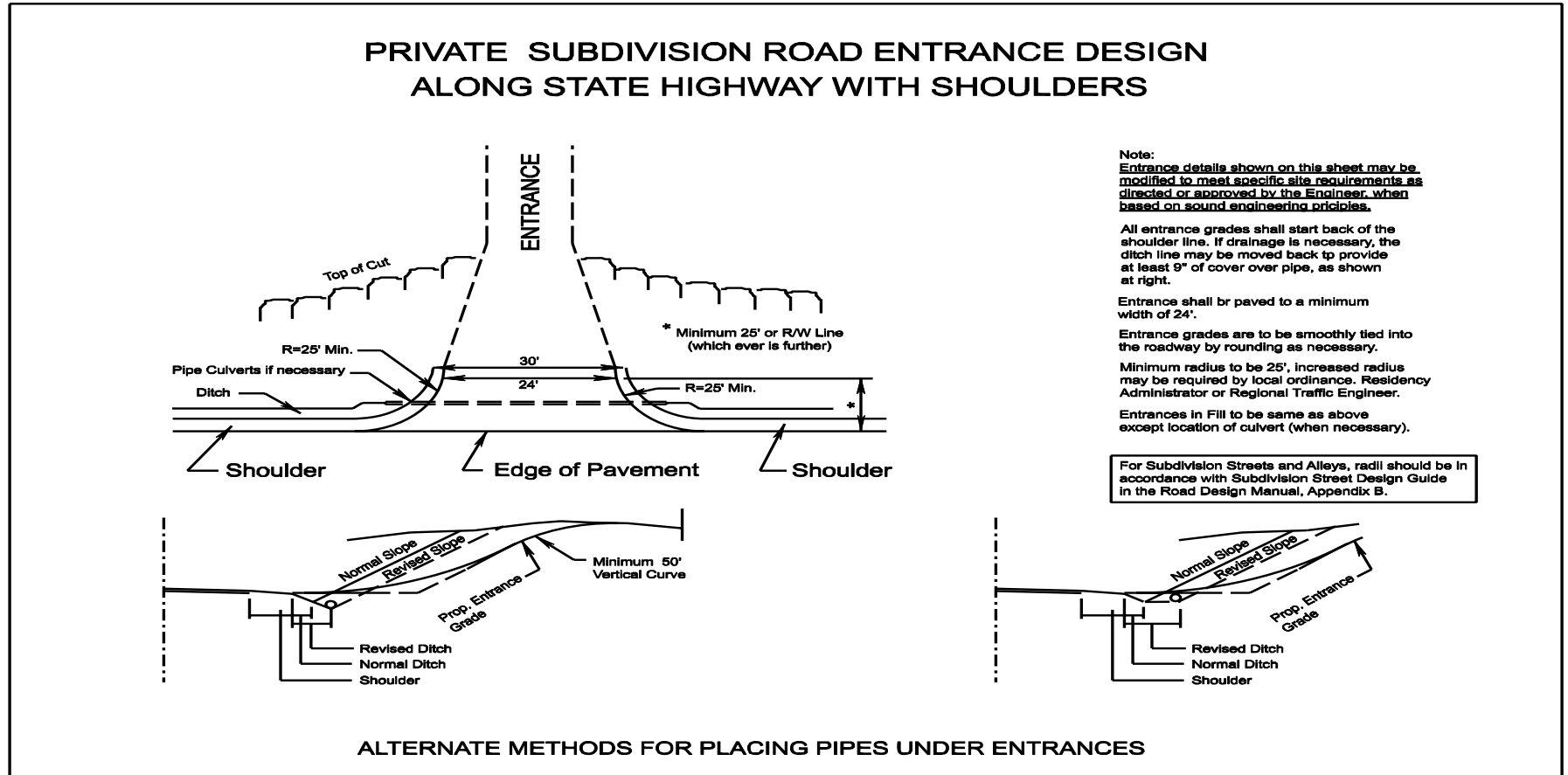

FIGURE 4-7

Standard Private Subdivision Road / Street Entrance



**FIGURE 4- 8 STANDARD PRIVATE SUBDIVISION ROAD / STREET ENTRANCE**

**Note:** All entrance design and construction shall accommodate pedestrian and bicycle users of the highway in accordance with the Commonwealth Transportation Board's "Policy for Integrating Bicycle and Pedestrian Accommodations".

## Commercial Entrance Designs along Highways with Shoulders

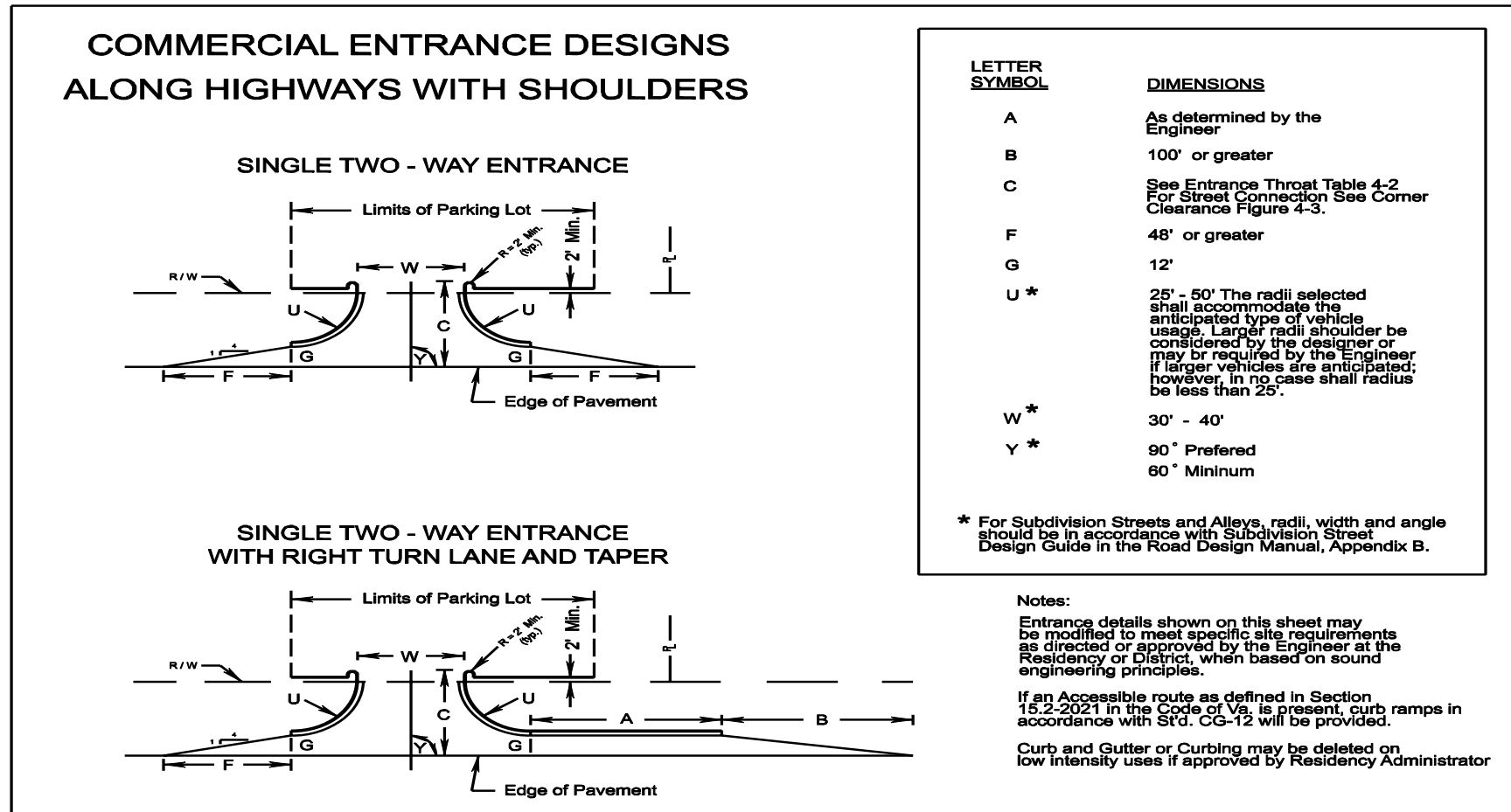
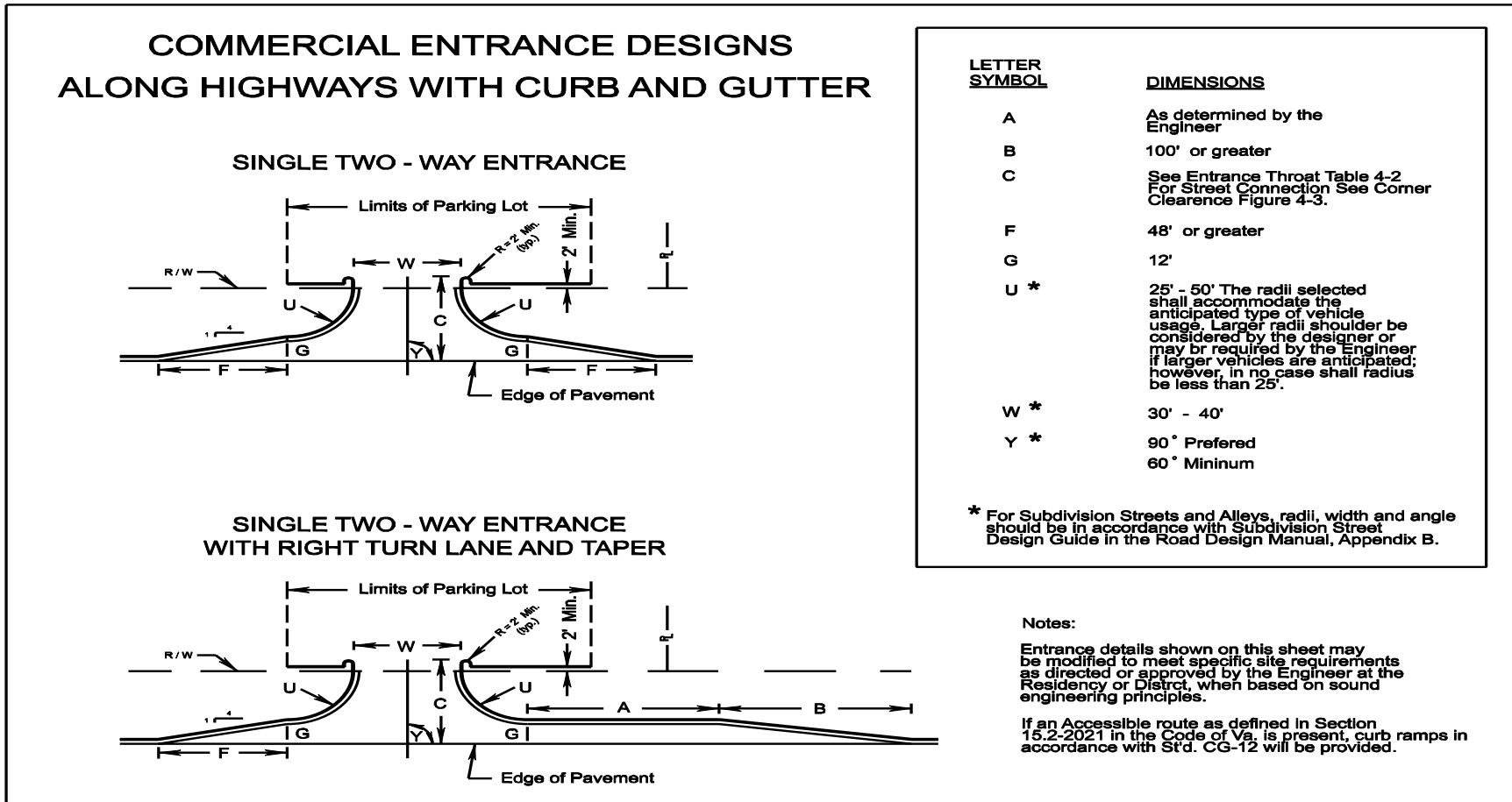

**FIGURE 4- 9 COMMERCIAL ENTRANCE DESIGNS ALONG HIGHWAYS WITH SHOULDERS**

**Note:** All entrance design and construction shall accommodate pedestrian and bicycle users of the highway in accordance with the Commonwealth Transportation Board's "Policy for Integrating Bicycle and Pedestrian Accommodations".

**Note:** For Commercial Entrances along all Highways that are NOT Functionally Classified as Principal Arterials, see the entrance design illustrations in the Minimum Standards of Entrances to State Highways, Section 24 VAC 30-71-160.

Commercial Entrance Designs along Highways with Curb and Gutter

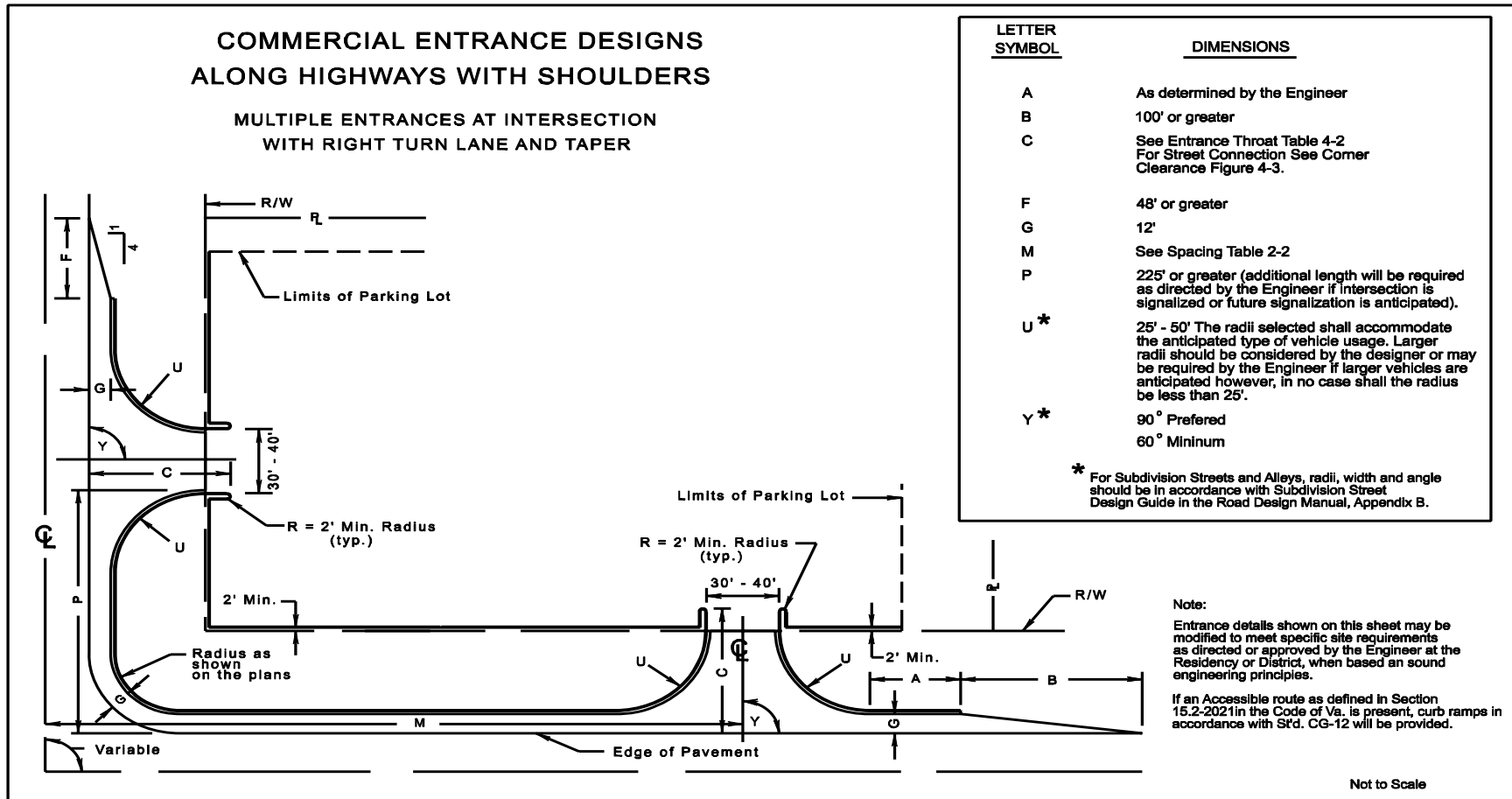

**FIGURE 4-10 COMMERCIAL ENTRANCE DESIGNS ALONG HIGHWAYS WITH CURB AND GUTTER**

**Note:** All entrance design and construction shall accommodate pedestrian and bicycle users of the highway in accordance with the Commonwealth Transportation Board's "Policy for Integrating Bicycle and Pedestrian Accommodations".

**Note:** For Commercial Entrances along all Highways that are NOT Functionally Classified as Principal Arterials, see the entrance design illustrations in the Minimum Standards of Entrances to State Highways, Section 24 VAC 30-71-160.

## Commercial Entrance Designs along Highways with Shoulders at Intersection

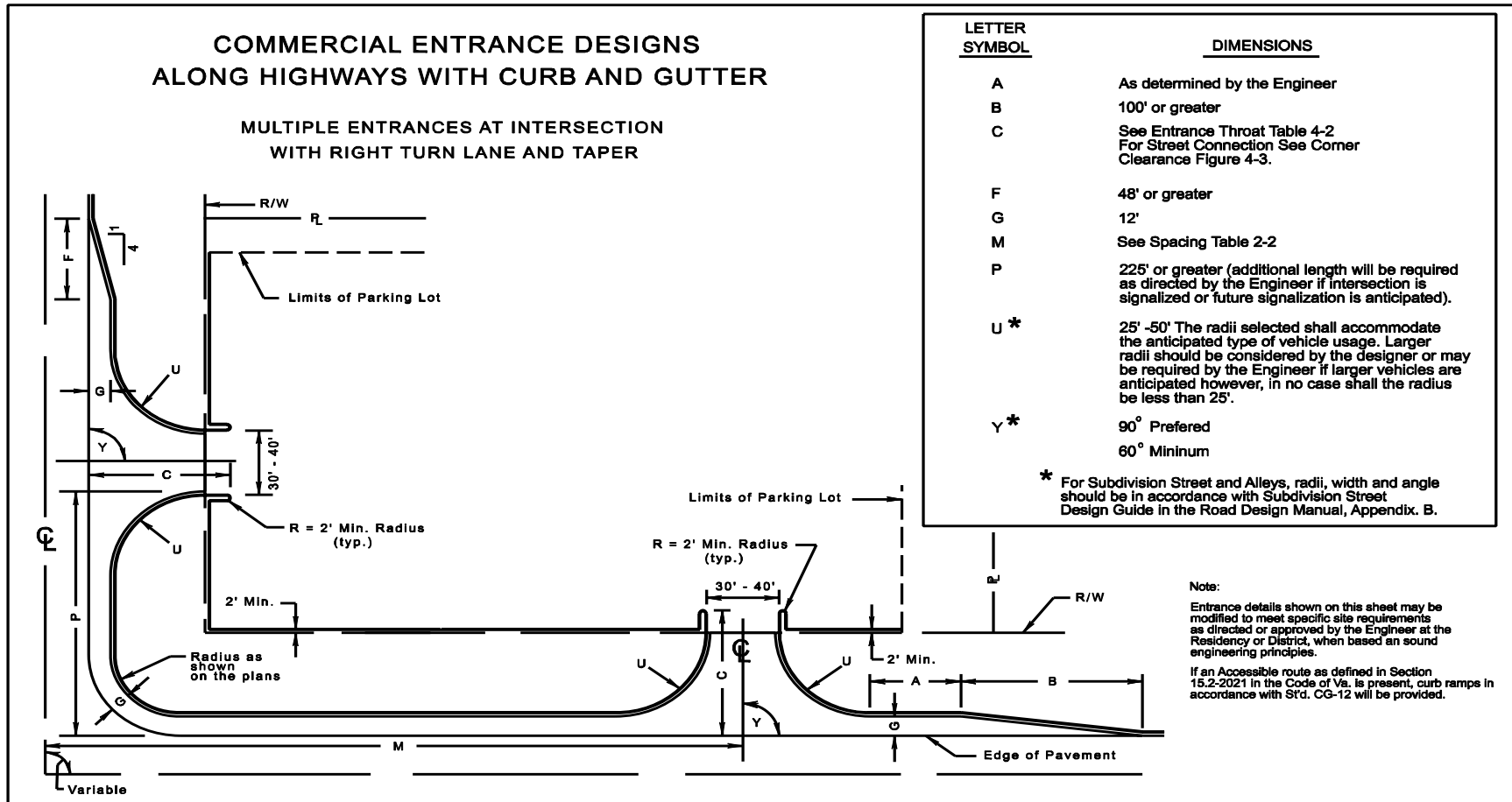

**FIGURE 4-11 COMMERCIAL ENTRANCE DESIGNS ALONG HIGHWAYS WITH SHOULDERS AT INTERSECTION**

**Note:** All entrance design and construction shall accommodate pedestrian and bicycle users of the highway in accordance with the Commonwealth Transportation Board's "Policy for Integrating Bicycle and Pedestrian Accommodations".

**Note:** For Entrances along all Highways that are NOT Functionally Classified as Principal Arterials, see the entrance design illustrations in the Minimum Standards of Entrances to State Highways, Section 24 VAC 30-71-160.

**Commercial Entrance Designs along Highways with Curb and Gutter at Intersection**



**FIGURE 4-12 COMMERCIAL ENTRANCE DESIGNS ALONG HIGHWAYS WITH CURB AND GUTTER AT INTERSECTION**

**Note:** All entrance design and construction shall accommodate pedestrian and bicycle users of the highway in accordance with the Commonwealth Transportation Board’s “Policy for Integrating Bicycle and Pedestrian Accommodations”.

**Note:** For Entrances along all Highways that are NOT Functionally Classified as Principal Arterials, see the entrance design illustrations in the Minimum Standards of Entrances to State Highways, Section 24 VAC 30-71-160.



### Commercial Entrance Designs along Highways with Shoulders

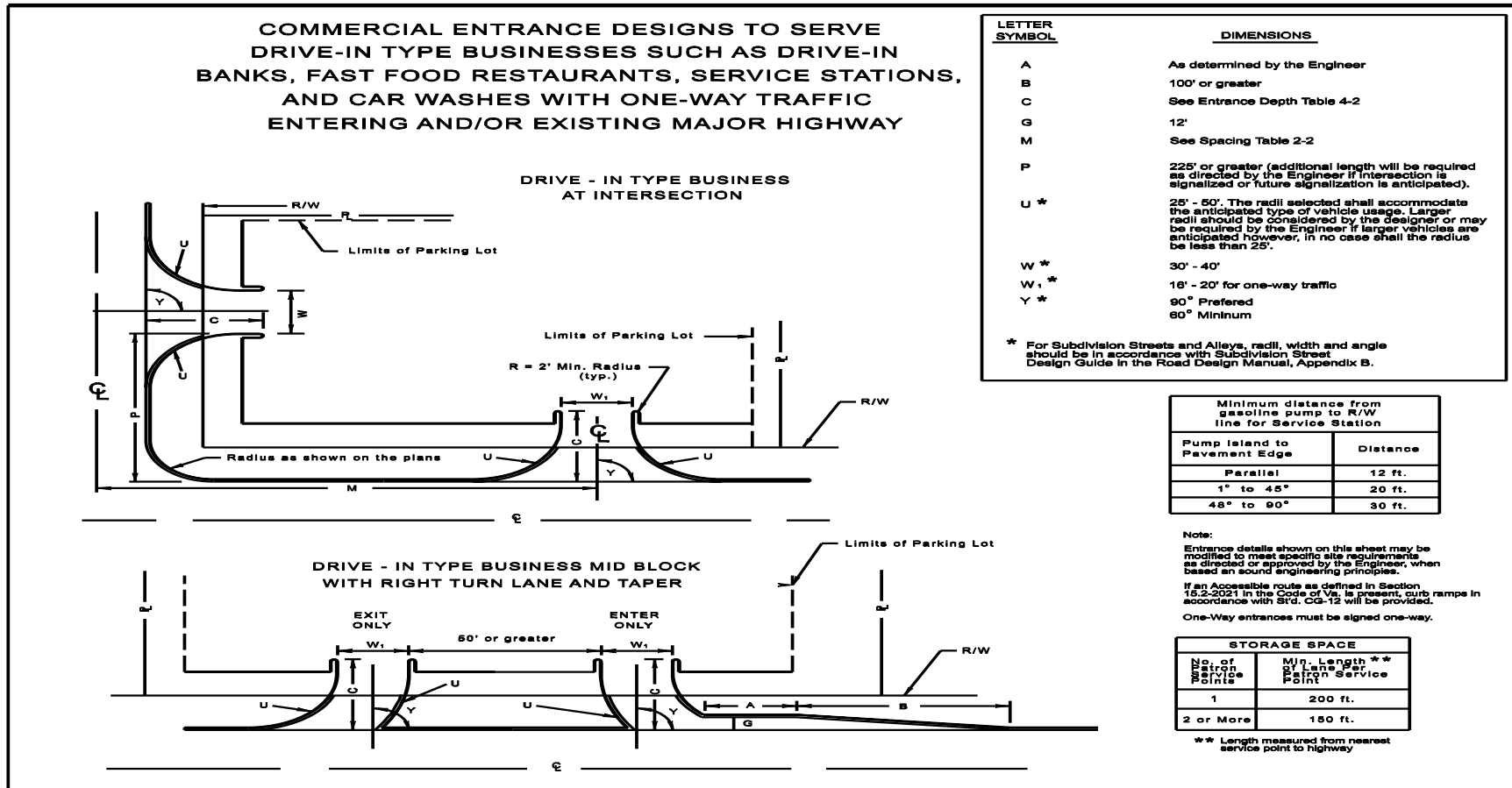

**FIGURE 4-13 COMMERCIAL ENTRANCE DESIGNS ALONG HIGHWAYS WITH SHOULDERS**

**Note:** All entrance design and construction shall accommodate pedestrian and bicycle users of the highway in accordance with the Commonwealth Transportation Board’s “Policy for Integrating Bicycle and Pedestrian Accommodations”.

**Note:** For Entrances along all Highways that are NOT Functionally Classified as Principal Arterials, see the entrance design illustrations in the Minimum Standards of Entrances to State Highways, Section 24 VAC 30-71-160.