

TABLE OF CONTENTS

APPENDIX C

SECTION C-1-DESIGN FEATURES

CROSSOVER SPACING	C-1
CROSSOVER GRADES	C-2
INTERSECTING CROSS ROAD GRADES	C-4
LEFT-TURN LANES	C-4
WARRANTS FOR LEFT-TURN STORAGE LANES ON TWO-LANE HIGHWAYS	C-6
DOUBLE (DUAL) LEFT-TURN LANES	C-19
CROSSOVERS WITH AND WITHOUT CONNECTIONS	C-22
INTERSECTION DESIGN	C-22
ROUNDBABOUTS:	C-23
THE APPROVAL PROCESS FOR ROUNDBABOUTS:	C-23
SIGHT DISTANCE	C-28
RIGHT TURN LANES	C-33
ENTRANCES	C-34
SAFETY REST AREAS	C-36
PARKING SPACES	C-37
ACCESSIBLE PARKING AND PASSENGER LOADING ZONES	C-39
ACCESS AISLE FOR ACCESSIBLE LOADING ZONES	C-39

SECTION C-2-ENVIRONMENTAL

NOISE ABATEMENT	C-44
NOISE ABATEMENT DECISION FLOW PROCESS	C-44
PRELIMINARY PLAN REVIEW	C-44
DRAFT EIS	C-44
LOCATION PUBLIC HEARINGS	C-45
FINAL ENVIRONMENTAL IMPACT STATEMENT (EIS)	C-45
FIELD INSPECTION & FINAL DES. OF ABATEMENT FEATURES	C-45
DESIGN PUBLIC HEARING	C-45
PUBLIC INTERACTION	C-45
DECISION	C-46
APPROVAL OF THE NOISE STUDY	C-46
RIGHT OF WAY	C-46
PLANS, SPECIFICATIONS AND ESTIMATES (PS & E)	C-46
CONSTRUCTION REVIEW	C-46

SECTION C-3 RIGHT OF WAY

CRITERIA FOR PLACEMENT OF RIGHT OF WAY MONUMENTS..... C-47

SECTION C-4-WATER RELATED PERMITS

REVIEW OF PUBLIC NOTICES..... C-50
INTRODUCTION (PERMIT APPLICATION)..... C-50
PERMIT APPLICATION PROCEDURE..... C-51
DRAWING REQUIREMENTS..... C-55
DRAWING CHECKLIST (TO BE STRICTLY ADHERED TO) C-58
HYDRAULIC COMMENTARY FOR PERMIT APPLICATIONS..... C-64
DISTRIBUTION OF COPIES OF PERMIT APPLICATIONS..... C-65
**GENERAL CONSTRUCTION NOTES AND EROSION AND SILTATION
CONTROL NARRATIVE..... C-65**
PROJECT 0604-004-140,B-615
ROUTE 604 OVER FLAT CREEK C-70

SECTION C-5 SAFETY PROJECTS

PROCEDURES C-76

SECTION C-6- SITE PLAN REVIEW

I. CHECKLISTS FOR SITE PLAN COMPLETENESS C-79
A. HOW TO USE THE CHECKLISTS..... C-79
**B. CHECKLIST FOR PRELIMINARY SITE PLAN/REZONING
APPLICATION COMPLETENESS..... C-79**
I. PROJECT IDENTIFICATION C-79
II. GENERAL SITE INFORMATION C-80
III. STATEMENTS C-80
CHECKLIST FOR SITE COMPLETENESS..... C-80
I. GENERAL INFORMATION (IDENTIFICATION) C-81
II. GEOMETRICS C-81
A. GENERAL..... C-81
B. ROADS C-82
C. OTHER..... C-82
III. DRAINAGE..... C-82
IV. UTILITIES C-83
V. TRAFFIC ANALYSIS C-84
VI. COMMENTS C-84
II. SITE PLAN REVIEW CHECKLIST C-85
I. ACCURACY AND COMPATIBILITY..... C-85
II. INTERNAL CIRCULATION PATTERN..... C-85
III. INTERSECTION GEOMETRICS C-86

IV. INTERSECTION SIGHT DISTANCES	C-86
V. AUXILIARY LANES.....	C-86
VI. PEDESTRIANS.....	C-87
VII. SIGNALIZATION	C-87
VIII. SIGNING AND PAVEMENT MARKINGS.....	C-87
IX. FENCING	C-88
X. ROADSIDE OBSTACLES.....	C-88
XI. ROADWAY LIGHTING.....	C-88
XII. RIGHT OF WAY.....	C-88
XIII. DRAINAGE	C-88
XIV. REVIEW COMMENTS	C-89
III. GUIDELINES FOR A TRAFFIC IMPACT STUDY	C-90
A. PURPOSE.....	C-90
B. RESPONSIBILITIES FOR TRAFFIC IMPACT STUDIES	C-90
C. DETERMINING THE NEED FOR A TRAFFIC IMPACT STUDY	C-91
D. TRAFFIC IMPACT STUDY CONTENTS AND SPECIFICATIONS	C-91
CHAPTER 1. INTRODUCTION	C-94
CHAPTER 2. ANALYSIS OF EXISTING CONDITIONS	C-95
CHAPTER 3. ANALYSIS OF FUTURE CONDITIONS WITHOUT DEVELOPMENT	C-95
CHAPTER 4. TRIP GENERATION	C-96
CHAPTER 5. TRIP DISTRIBUTION.....	C-96
CHAPTER 6. TRAFFIC ASSIGNMENT	C-96
CHAPTER 7. ANALYSIS OF FUTURE CONDITIONS WITH DEVELOPMENT	C-96
CHAPTER 8. RECOMMENDED IMPROVEMENT	C-97
CHAPTER 9. CONCLUSION.....	C-97
IV. ROLES OF VDOT OFFICES IN SITE PLAN REVIEW	C-98
A. RESIDENCY OFFICES	C-98
B. DISTRICT OFFICES.....	C-99
C. CENTRAL OFFICE	C-100
D. SITE PLAN REVIEW PROCESS THROUGH VDOT	C-101
V. COORDINATION WITH COUNTY GOVERNMENTS IN SITE PLAN REVIEW.....	C-105
 SPIRAL CURVES.....	 C-106

LIST OF FIGURES

	Page
TABLE C-1-1 CROSSOVER SPACING CRITERIA.....	C-1
FIGURE C-1-1	C-5
FIGURE C-1-1.1 WARRANT FOR LT. TURN STORAGE LANES ON 4-LANE HWY.....	C-6
TABLE C-1-2 WARRANTS FOR LEFT-TURN LANES ON TWO-LANE HIGHWAYS.....	C-7
TABLE C-1-2.1 TRUCK ADJUSTMENTS	C-17
FIGURE C-1-1.20.....	C-18
FIGURE C-1-2 DOUBLE LEFT-TURN LANES	C-20
FIGURE C-1-2.1 CONTINUOUS TWO-WAY MEDIAN LEFT-TURN LANES	C-21
FIGURE C-1-2.2 ROUNDABOUT DETAILS	C-24
FIGURE C-1-3 CROSSOVERS WITH AND WITHOUT CONNECTIONS	C-25
FIGURE C-1-4 INTERSECTION DESIGN	C-26
FIGURE C-1-5 INTERSECTION DESIGN	C-27
TABLE C-1-3 STOPPING SIGHT DISTANCE	C-28
TABLE C-1-4 PASSING SIGHT DISTANCE	C-28
TABLE C-1-5 INTERSECTION SIGHT DISTANCES ALONG MAJOR RD. & INTERSECTION WITH MINOR ROADS, X-OVERS & COMMERCIAL ENTR.	C-29
FIGURE C-1-8 GUIDELINES FOR RT. TURN TREATMENT (2-LANE HIGHWAY)	C-31
FIGURE C-1-9 GUIDELINES FOR RT. TURN TREATMENT (4-LANE HIGHWAY)	C-32
FIGURE C-1-10.1 DESIGNS FOR ACCESSIBLE PARKING SPACES.....	C-39
FIGURE C-1-11 DESIGN GUIDE FOR SAFETY REST AREAS.....	C-40
FIGURE C-1-12 DESIGN GUIDE FOR SAFETY REST AREAS.....	C-41
FIGURE C-1-13 DESIGN FOR ANGLE PARKING OF TRUCKS.....	C-42
SUMMARY OF PARKING SPACE ARRANGEMENTS.....	C-43
FIGURE C-1-14 DESIGN FOR PARKING SPACES	C-43
FIGURE C-3-1 SURVEY PROPERTY LINE TIE AND PROP. R/W BREAK POINT	C-49
PERMIT APPLICATIONS	C-51
FIGURE C-4-1 PLAN AND PROFILE - PERMIT (ROUGH SKETCH)	C-53
FIGURE C-4-2 PERMIT APPLICATION FLOW CHART	C-54
FIGURE C-4-5 PROPOSED BRIDGE EXCAVATION AND CAUSEWAY SKETCH	C-69
FIGURE C-4-7 CULVERT (NON-TIDAL) -TYPICAL SECTION & PROFILE VIEW	C-73
FIGURE C-6-1 PARTIAL SITE PLAN PREVIEW PROCESS.....	C-102
FIGURE C-6-2 COMPLETE SITE PLAN REVIEW PROCESS	C-103
FIGURE C-6-3 SUBDIVISION STREET PLAN REVIEW PROCEDURE	C-104
FIGURE C-6-5 COORDINATE POINTS ON THE SPIRAL.....	C-108
FIGURE C-6-6 HORIZONTAL CURVES EXAMPLE	C-109
FIGURE C-6-7 SIMPLE CURVE COMPUTATIONS.....	C-110
FIGURE C-6-8 COMPOUND CURVE COMPUTATIONS	C-111
FIGURE C-6-9 PARABOLIC VERTICAL CURVE COMPUTATIONS	C-112
TABLE C-6-1 INCHES AND FRACTIONS OF AN INCH IN DECIMALS OF A FT.	C-113
FIGURE C-6-10 REFERENCE FORMULAS - 90 DEGREES TRIANGLE	C-114
FIGURE C-6-11 REFERENCE FORMULAS OBLIQUE TRIANGLE.....	C-115

APPENDIX C

SECTION C-1-DESIGN FEATURES

CROSSOVER SPACING

Criteria Table C-1-1 shows crossover spacing and sight distance requirements to be applied on all divided highways without full control of access. The minimum sight distance requirement indicated in Table C-1-1 must be met at all crossover locations. Crossover spacing less than shown as minimum will be considered when required by intersecting public highways or streets with a current ADT of 100 or greater. Other crossovers will only be allowed after an individual traffic safety and operational study.

The following are some factors, but not all inclusive, that should be considered in the study, if applicable: Operating speed, volume of traffic for crossover and through routes, signal operation/progression, accidents with and without additional crossover, number of U-turns, weaving maneuvers, alternative solution, capacity analysis, type of vehicles such as school buses, trucks, etc. Final approval will be required by the State Traffic Engineer and the State Location and Design Engineer.

DESIGN SPEED of HIGHWAY (MPH)	CROSSOVER SPACING⊗		MINIMUM SIGHT DISTANCE (FEET)
	DESIRABLE (FEET)	MINIMUM (FEET)	
70	1250	1000	825
60	1100	900	710
55	1000	800	650
50	900	700	590
45	800	650	530
40	700	600	475
35	600	500	415

TABLE C-1-1 CROSSOVER SPACING CRITERIA

Sight distance determinations apply both horizontally and vertically and are to be based on a height of driver's eye of 3.5' and a height of object 3.5' measured each way.

⊗ Crossover spacing is measured from center to center.*

* Rev. 7/07

All plans at the field inspection stage are to show only those crossovers at public highways and streets which meet these criteria or at other locations that preliminary planning and traffic studies have warranted. The determination of additional crossovers will be the result of field inspection recommendations of the District Administrator, the State Traffic Engineer, (or other appropriate Engineer) and the State L & D Engineer.

The approval of the crossovers is the responsibility of the State Traffic Engineer and the State L & D Engineer, with the final responsibility for the location of crossover layout on plans resting with the State L & D Engineer.

Plans at right of way stage are to indicate the crossovers as determined and approved by the above criteria. Any plans that are revised for crossovers during construction are to be approved as indicated above. When construction has been completed, the approval of the addition or deletion of crossovers will be the responsibility of the State Traffic Engineer (or other appropriate Engineer) with the concurrence of the State Location and Design Engineer. It will be the responsibility of the Traffic Engineer to coordinate such changes with the State Location and Design Engineer in order that these revisions of crossovers may be properly recorded on the original plans.

CROSSOVER GRADES

On divided highways with depressed medians, there are generally three methods by which superelevation is determined for the opposing traffic lanes.

One method is for the median pavement edges to be held at the same, or close to the same, elevation. A second method is for each baseline elevation to be approximately the same, with a corresponding difference in elevation of the median pavement edges. The third method is for the superelevation of all lanes to be obtained along a single plane. Thus, the grade of the lane on the outside of the curve is higher than the inside lane. The various methods are illustrated below:

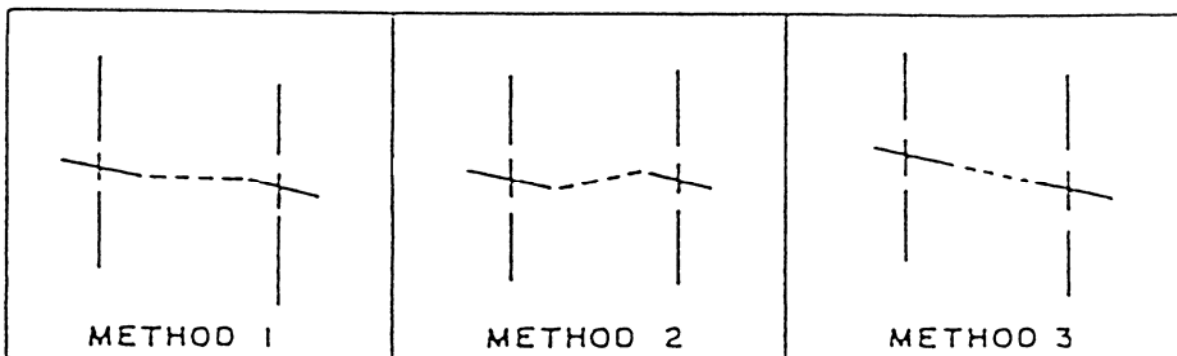

The designer is to study the requirements of each particular situation. In the case of a facility without crossovers, the first method above is generally acceptable on superelevated curves. This will allow the median area to be properly graded without creating an adverse design situation.

Method 2 generally results in an undesirable situation and must be used with caution.

In a case where a crossover is proposed, particularly in conjunction with a connecting road within the limits of a superelevated curve, the designer shall pay particular attention to the path which must be traversed by vehicles using the crossover.

In most cases, the application of the superelevation in a single plane (Method 3) is the acceptable method. This will allow a vehicle to cross from one lane to the other without negotiating several different gradients. As noted herein, this will require the adjustment of the mainline grades.

The desirable grade on a crossover is between 0.5% and 5%. The maximum grade should never exceed 10% as safe turning movements above this level are difficult. It is especially important at locations, such as truck stops and other businesses generating large vehicular traffic, that crossover grades fall in the category of less than 5%. A desirable maximum algebraic difference of a crossover crown line is 4 or 5 percent, but it may be as high as 8 percent at the locations where there are few trucks or school buses and low speeds. Additionally, sight distances must be checked for values shown in table for "Sight Distances along Major Road at Intersection with Minor Road and Crossovers and Commercial Entrances." (See Sight Distance Table C-1-5). Any deviation from these values is to be brought to the attention of the State Location and Design Engineer.

The grade on a crossover is measured from the edge of shoulder to the edge of shoulder, unless left turn lanes are provided, in which case the grade is applied from the edge of pavement of the left turn lane to the edge of pavement of the opposite left turn lane. This is more clearly shown in the following diagram:

Determination of Grade on a Crossover



In preparing plans for field inspection, the gradient at each crossover is to be plotted graphically.

INTERSECTING CROSS ROAD GRADES

The grade of a connecting facility must be carefully studied when approaching an intersection where the mainline is superelevated. A smooth grade tie-in is desirable, with sufficient area on a relatively flat grade for a vehicle to stop before entering the main roadway. Also, when a connection is on the outside of a superelevated curve, the grade must be designed so that the connection is visible to a driver on the main roadway desiring to turn onto the connection.

Every attempt must be made to provide an adequate area for this vehicular stoppage, giving full consideration to the horizontal and vertical sight distances.

The desirable tie-in is one that is no steeper than the pavement cross slope whether this is superelevated or the normal crown. The maximum difference between the pavement cross slope and the approach road grade shall not exceed 8% at stop intersections, or 4% at continuous-movement intersections. The stoppage area should be a minimum of 50' before beginning the steeper grade. (See AASHTO's [A Policy on Geometric Design of Highways and Streets](#))

LEFT-TURN LANES

As a general policy, left-turn lanes are to be provided for traffic in both directions in the design of all median crossovers on non-access controlled divided highways using controls as shown in Figure C-1-1. Left-turn lanes should also be established on two-lane highways where needed for storage of left-turn vehicles and/or prevention of thru-traffic delay.

LEFT AND RIGHT TURN STORAGE AND TAPER LENGTHS

<u>LENGTH OF STORAGE</u>		<u>TAPER - Rural and Urban</u>	
Rural - For Design Speeds 50 MPH or Higher	*L - 200' min. (For 240 or fewer vehicles during peak hour, <u>making turn</u>)	- For Design Speeds 35 MPH or Higher	**T - 200' Min.
- For Design Speeds 45 MPH Less than	*L - 100' min. (For 60 or fewer vehicles during peak hour, <u>making turn</u>)	- For Design Speeds <u>30 MPH or Less*</u>	**T - 100' Min.
	*Distance L to be adjusted upward as determined by capacity analysis for Left and Right Turn Storage.		**Tapers are to be straight-line unless local policy requires reverse curves. In congested areas the taper length may be reduced to increase storage length.
Urban - Length determined by capacity analysis for Left and Right Turn Storage			

Taper rates: 8:1 for design speeds up to 30 mph and 15:1 for design speeds between 35 and 50 mph. (Source: 2004 AASHTO "Green Book", page 716).

Note: Figures shown above were compiled using these formulas and were rounded up.

FIGURE C-1-1

Dimension "L" to be adjusted upward as determined by Figure C-1-1.1 or by capacity analysis for left-turn storage.

A capacity analysis is defined as a detailed analysis of the location in accordance with the guidelines contained in the current issue of the Highway Capacity Manual for intersection capacity and signalization requirements.

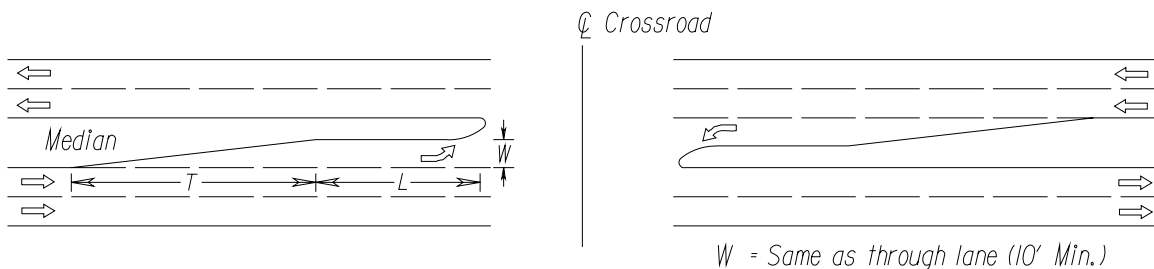

* Rev. 7/06

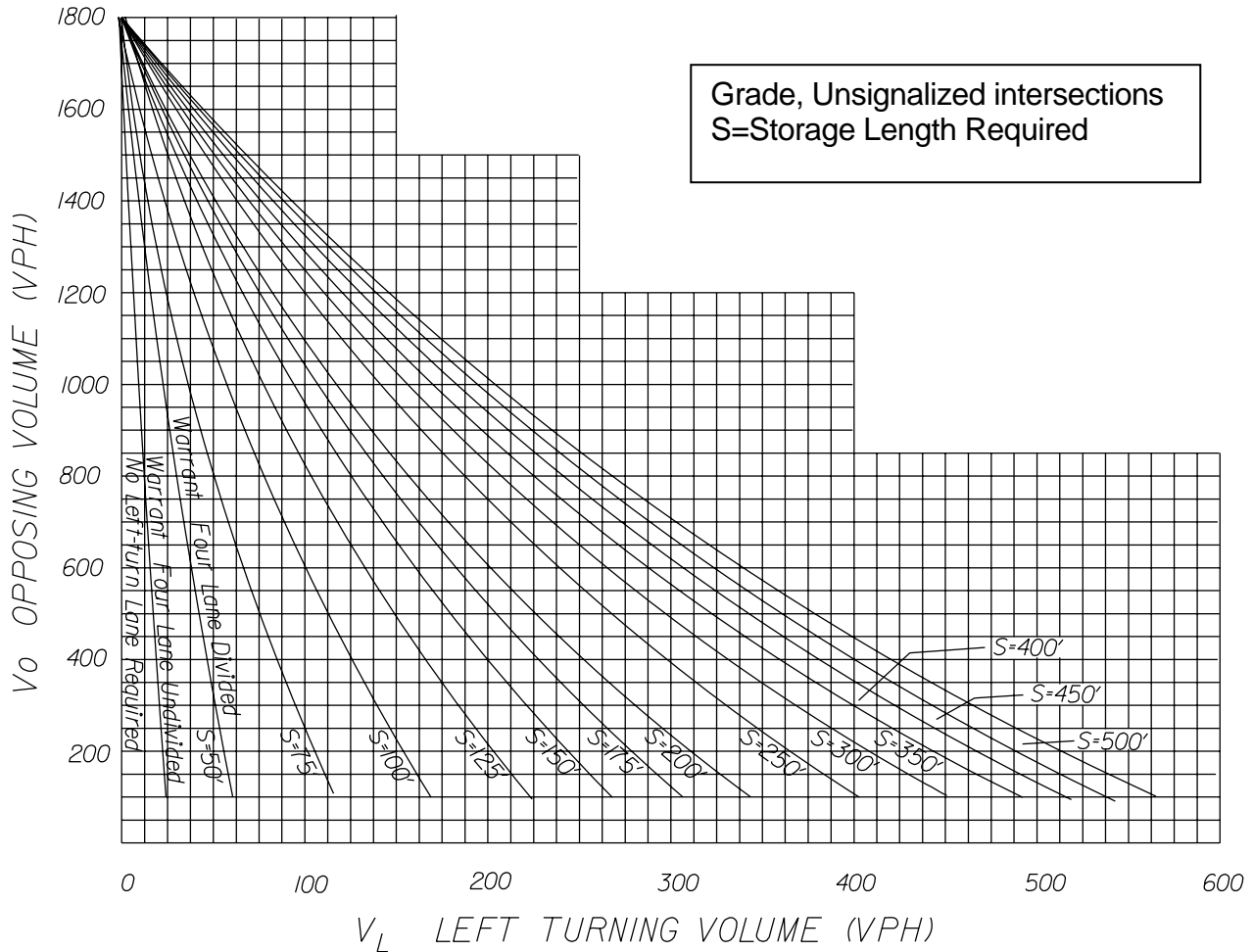

FIGURE C-1-1.1 WARRANT FOR LEFT TURN STORAGE LANES ON FOUR-LANE HIGHWAYS

When the Average Running Speed on an existing facility is available, the corresponding Design Speed may be obtained from [IIM LD- 117](#).

For plan detail requirements when curb and/or gutter are used, see [VDOT's Road Design Manual, Section 2E-3*](#).

Left-turn lanes should also be established on two-lane highways where traffic volumes are high enough to warrant them in accordance with the guidelines shown in Table C-1-2.

WARRANTS FOR LEFT-TURN STORAGE LANES ON TWO-LANE HIGHWAYS

The warrants in Table C-1-2 are taken from the 2004 AASHTO “Green Book”, Page 685, Exhibit 9-75. They were derived from Highway Research Report No. 211, Figures 2 through 19, for required storage length determinations.

* Rev. 1/07

The No. 211 study was undertaken to provide consistent volume warrants for left-turn storage lanes at unsignalized intersections.

VPH OPPOSING VOLUME	ADVANCING VOLUME			
	5%	10%	20%	30%
	LEFT TURNS	LEFT TURNS	LEFT TURNS	LEFT TURNS
40-MPH OPERATING SPEED/DESIGN SPEED*				
800	330	240	180	160
600	410	305	225	200
400	510	380	275	245
200	640	470	350	305
100	720	515	390	340
50-MPH OPERATING SPEED/DESIGN SPEED*				
800	280	210	165	135
600	350	280	195	170
400	430	320	240	210
200	550	400	300	270
100	615	445	335	295
60-MPH OPERATING SPEED/DESIGN SPEED*				
800	230	170	125	115
600	290	210	160	140
400	365	270	200	175
200	450	330	250	215
100	505	370	275	240

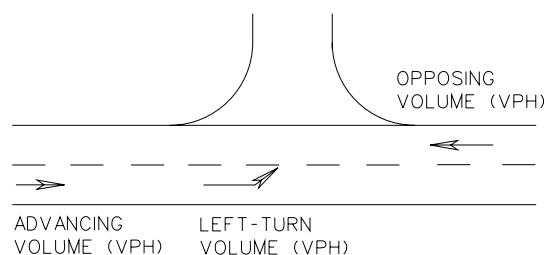

Example:

Two-lane highway with 40-MPH operating speed

Opposing Volume (VPH) - 600
 Advancing Volume (VPH) - 440
 Left-Turn Volume (VPH) - 44 or 10% of Advancing Volume

With opposing volume (VPH) of 600 and 10% of advancing volume (VPH) making left turns, and advancing volume (VPH) of 305 or more will warrant a left-turn lane.

Figure C-1-1.3 (page C-7) denotes that a 100' storage length is required.

Source: 2004 AASHTO Green Book, Page 685, Exhibit 9-75

* SPEED LIMIT MAY BE USED IF APPLICABLE, I.E. ADDING LANES TO EXISTING FACILITIES.

TABLE C-1-2 WARRANTS FOR LEFT-TURN LANES ON TWO-LANE HIGHWAYS

Figures C-1-1.2 through C-1-1.19 provide warrants for left-turn storage lanes on two-lane highways based on 5 to 30* percent left-turn volumes and operating speeds of 40, 50, and 60 MPH. Table C-1-2.1 provides the additional storage length required for 10 to 50 percent truck volumes.

Intersections with poor visibility and/or a bad accident record may require the designer to use engineering judgment when volume conditions alone do not warrant a storage lane.

* Rev. 7/06

WARRANT FOR LEFT-TURN STORAGE LANES ON TWO-LANE HIGHWAYS

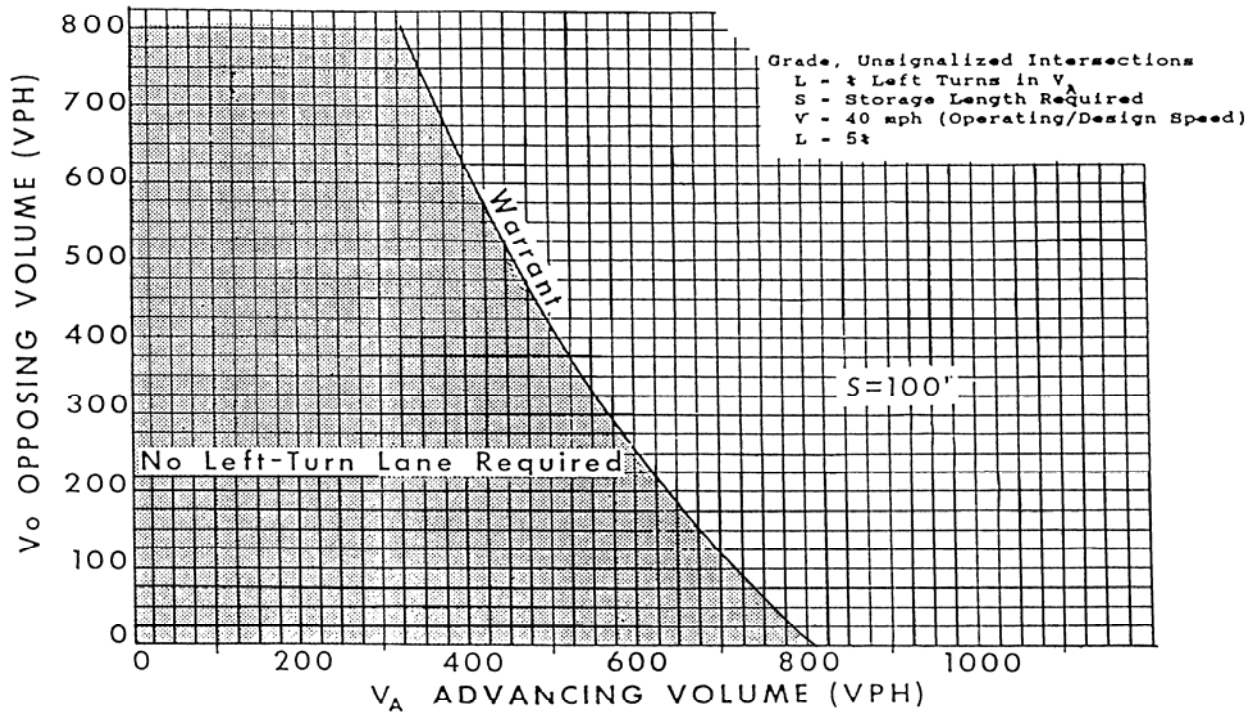

FIGURE C-1-1.2

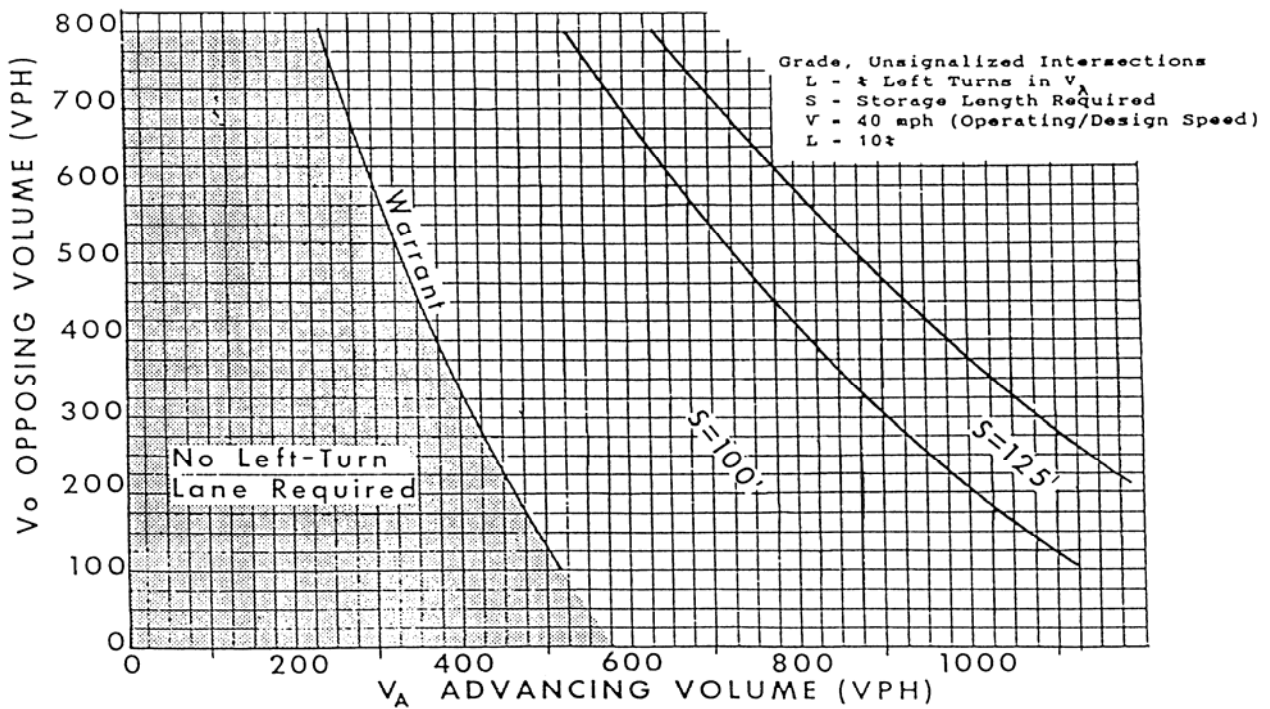

FIGURE C-1-1.3

WARRANT FOR LEFT-TURN STORAGE LANES ON TWO-LANE HIGHWAYS

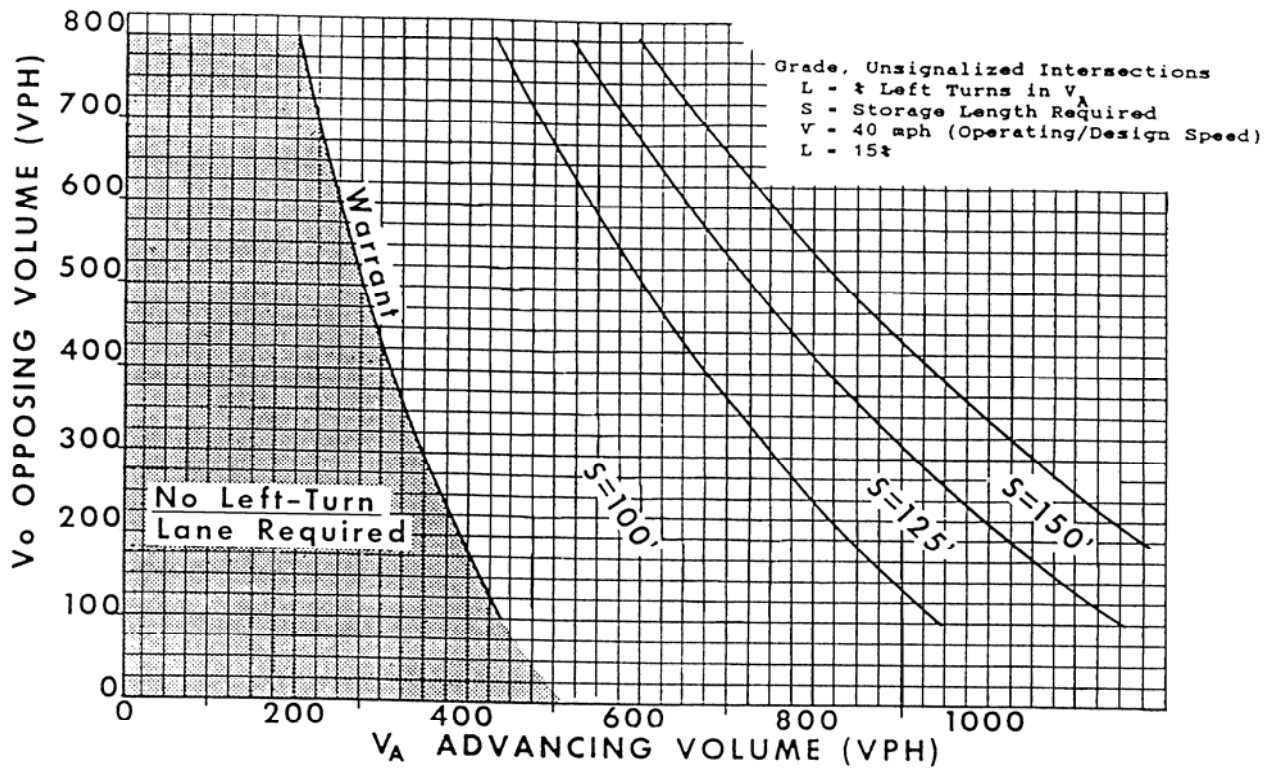

FIGURE C-1-1.4

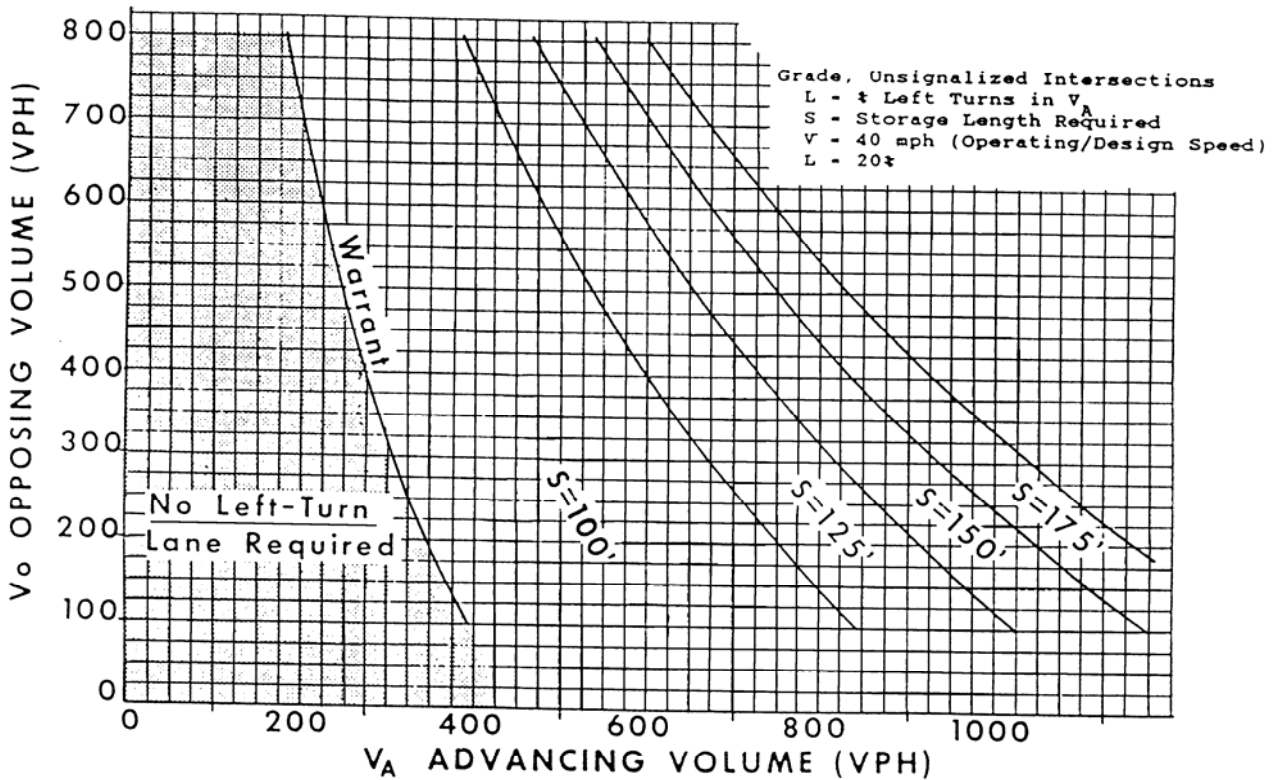

FIGURE C-1-1.5

WARRANT FOR LEFT-TURN STORAGE LANES ON TWO-LANE HIGHWAYS

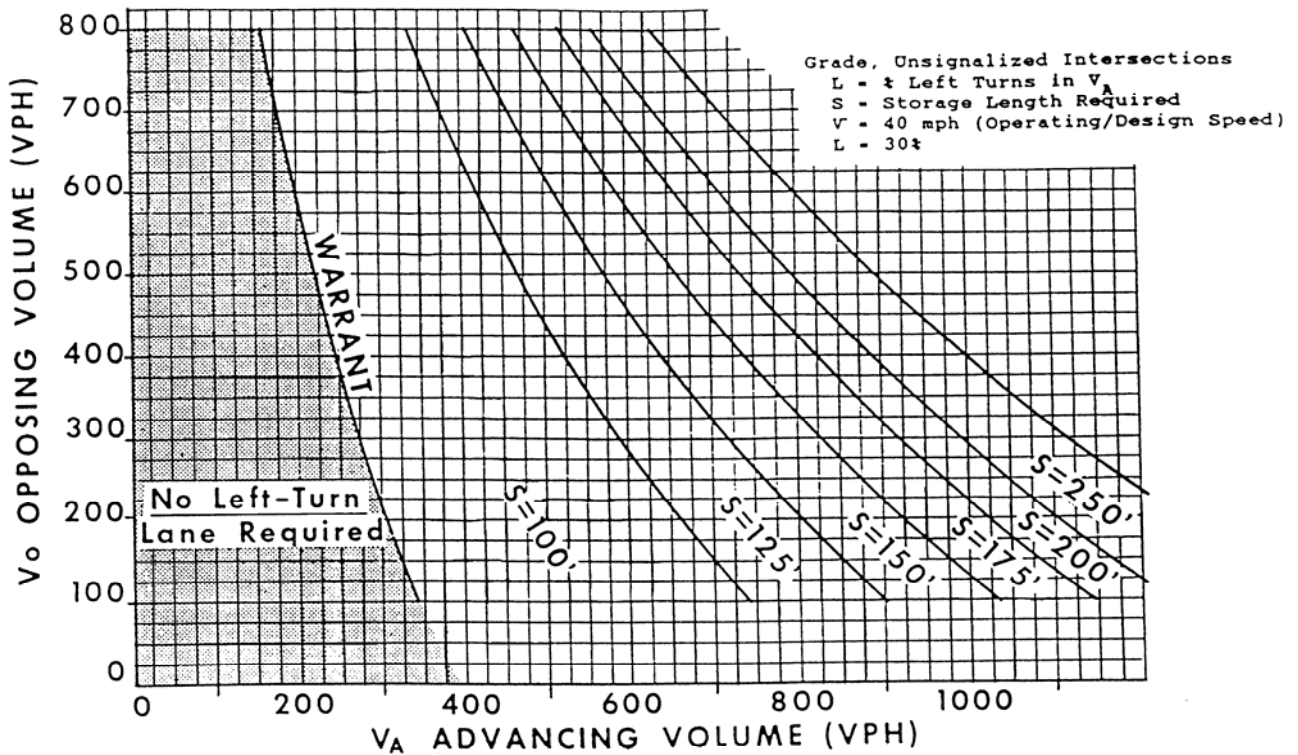

FIGURE C-1-1.6

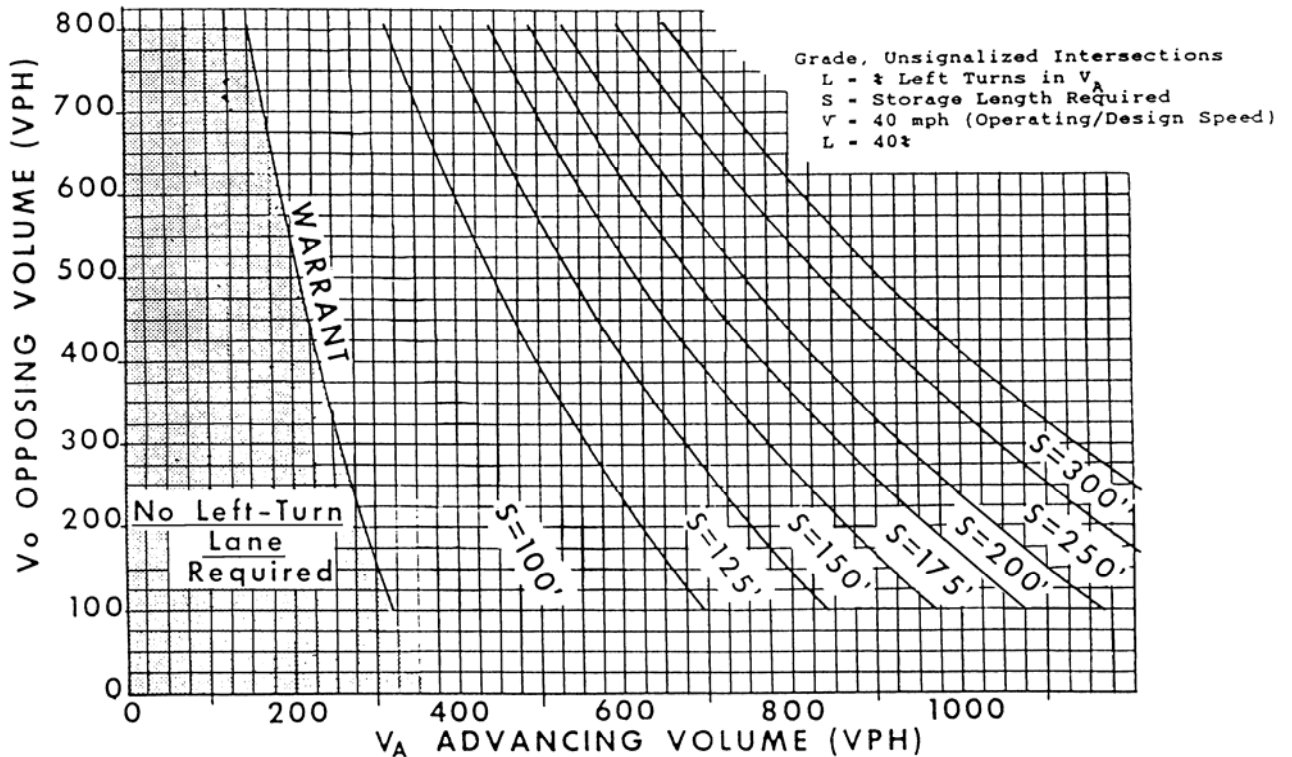

FIGURE C-1-1.7

WARRANT FOR LEFT-TURN STORAGE LANES ON TWO-LANE HIGHWAYS

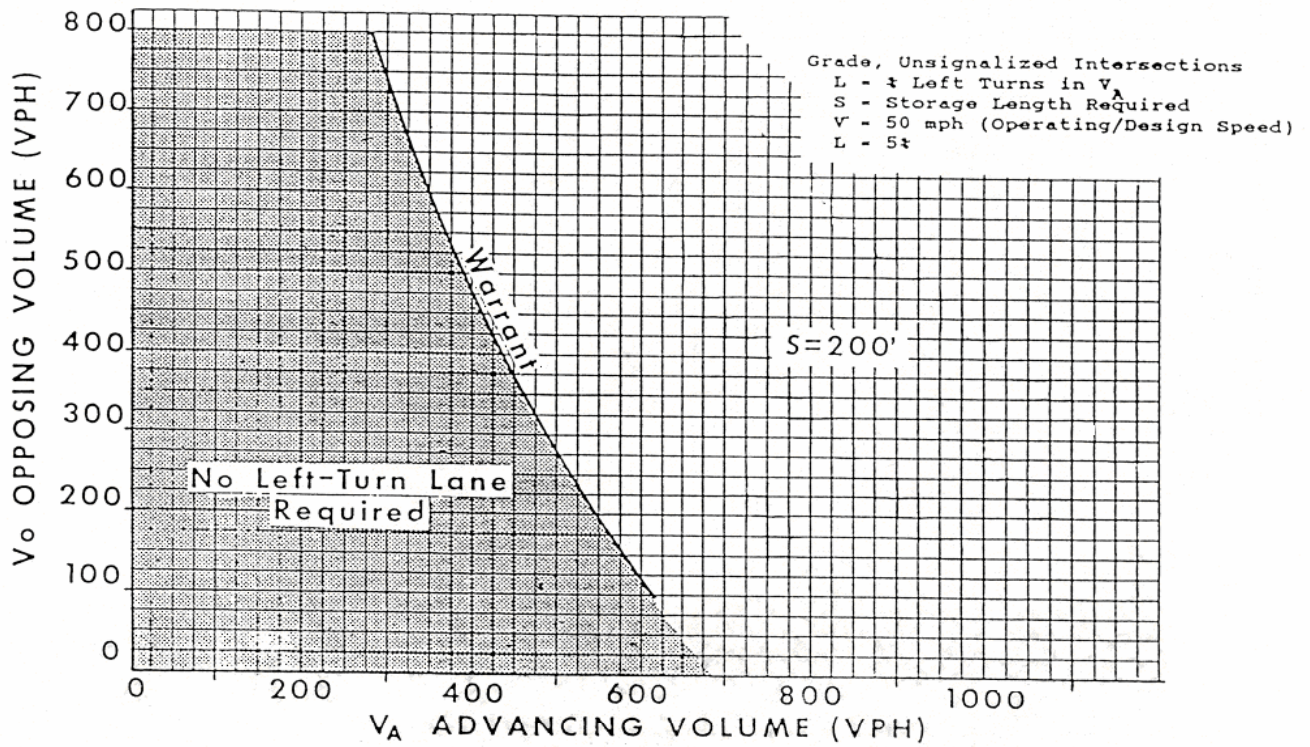

FIGURE C-1-1.8

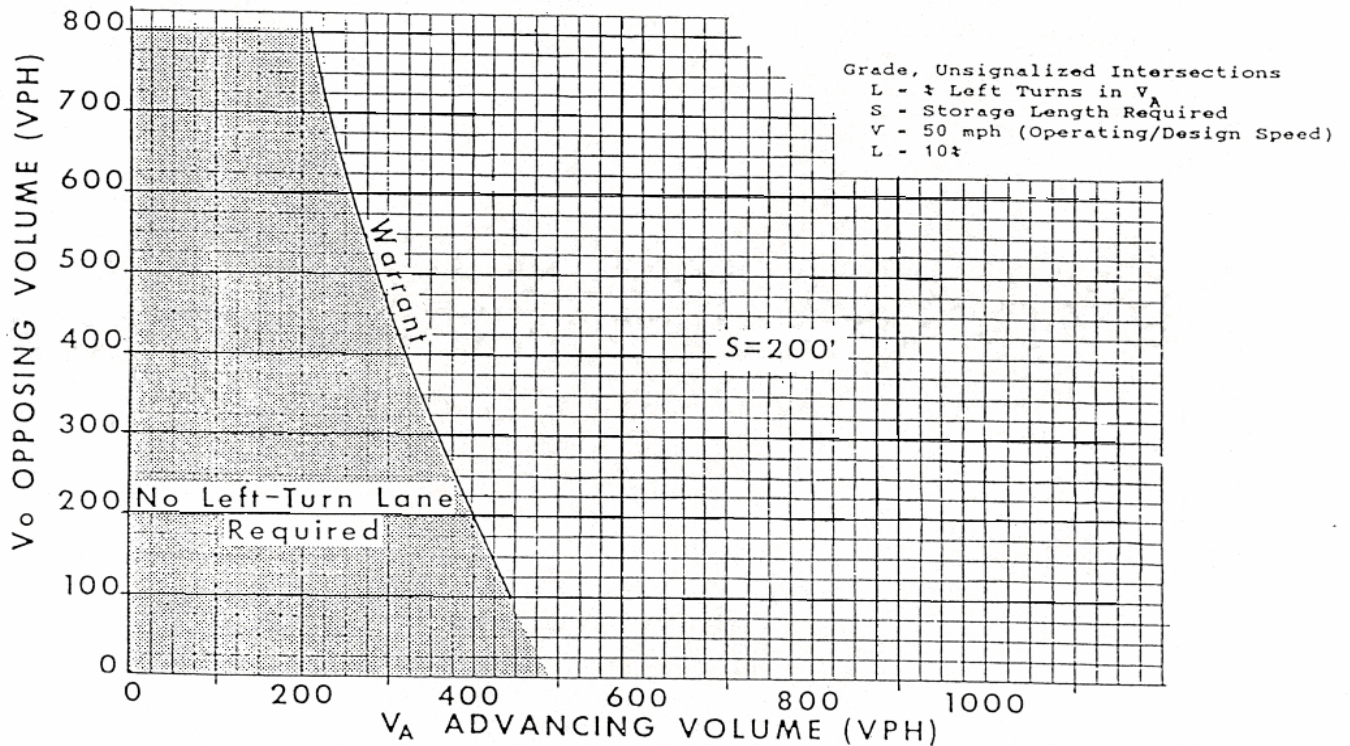

FIGURE C-1-1.9

WARRANT FOR LEFT-TURN STORAGE LANES ON TWO-LANE HIGHWAYS

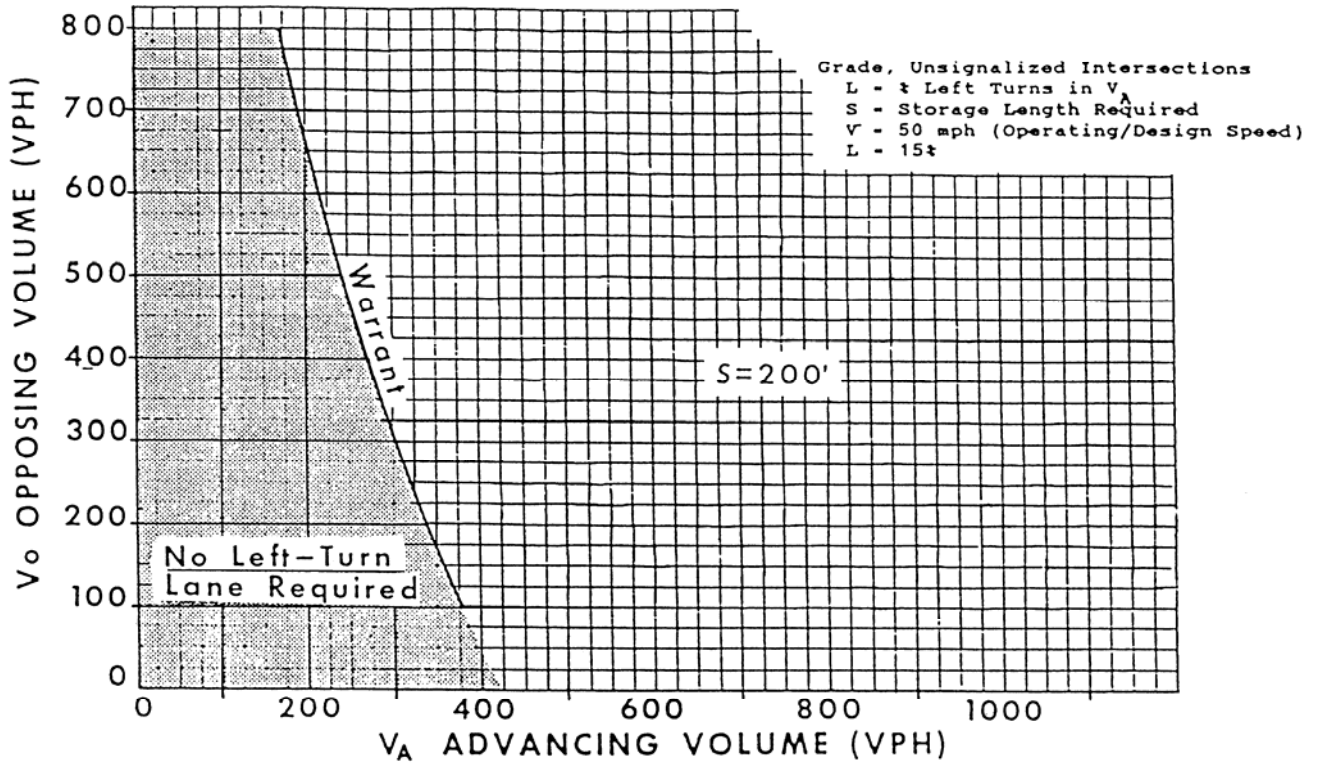

FIGURE C-1-1.10

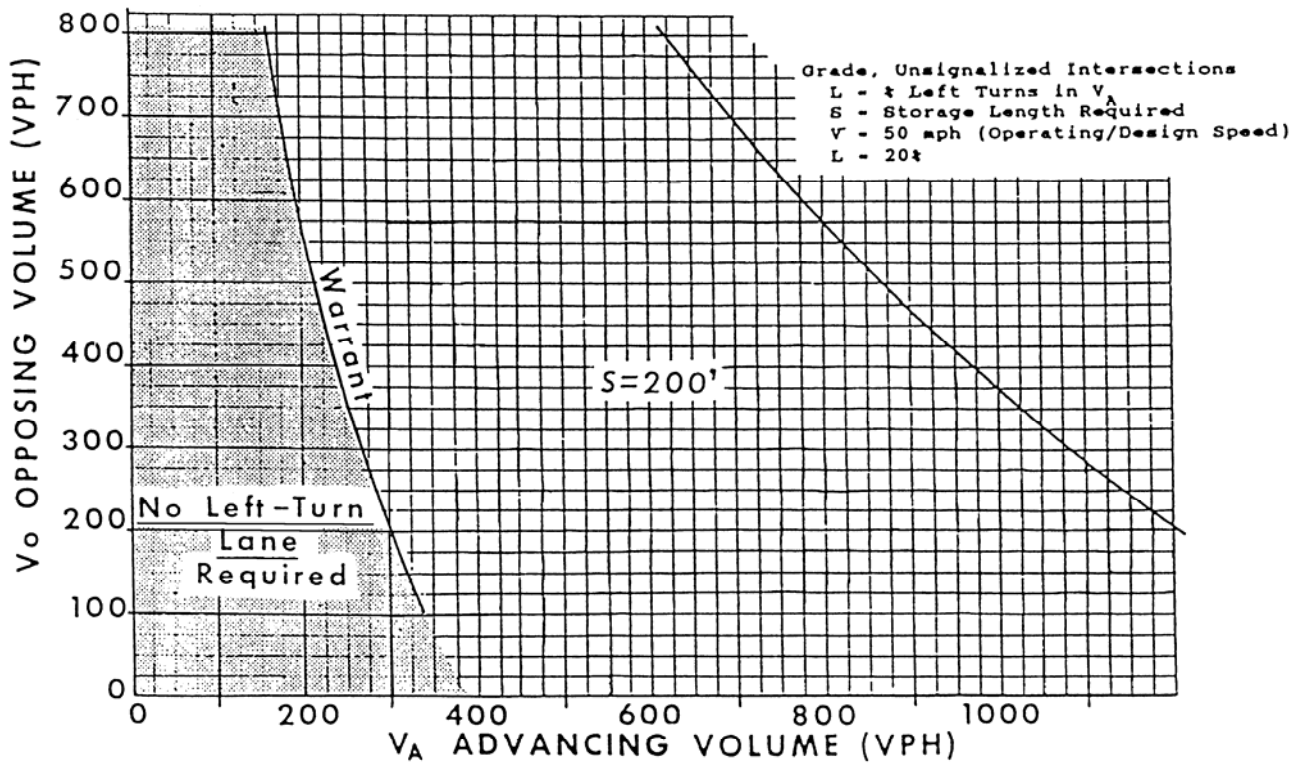

FIGURE C-1-1.11

WARRANT FOR LEFT-TURN STORAGE LANES ON TWO-LANE HIGHWAYS

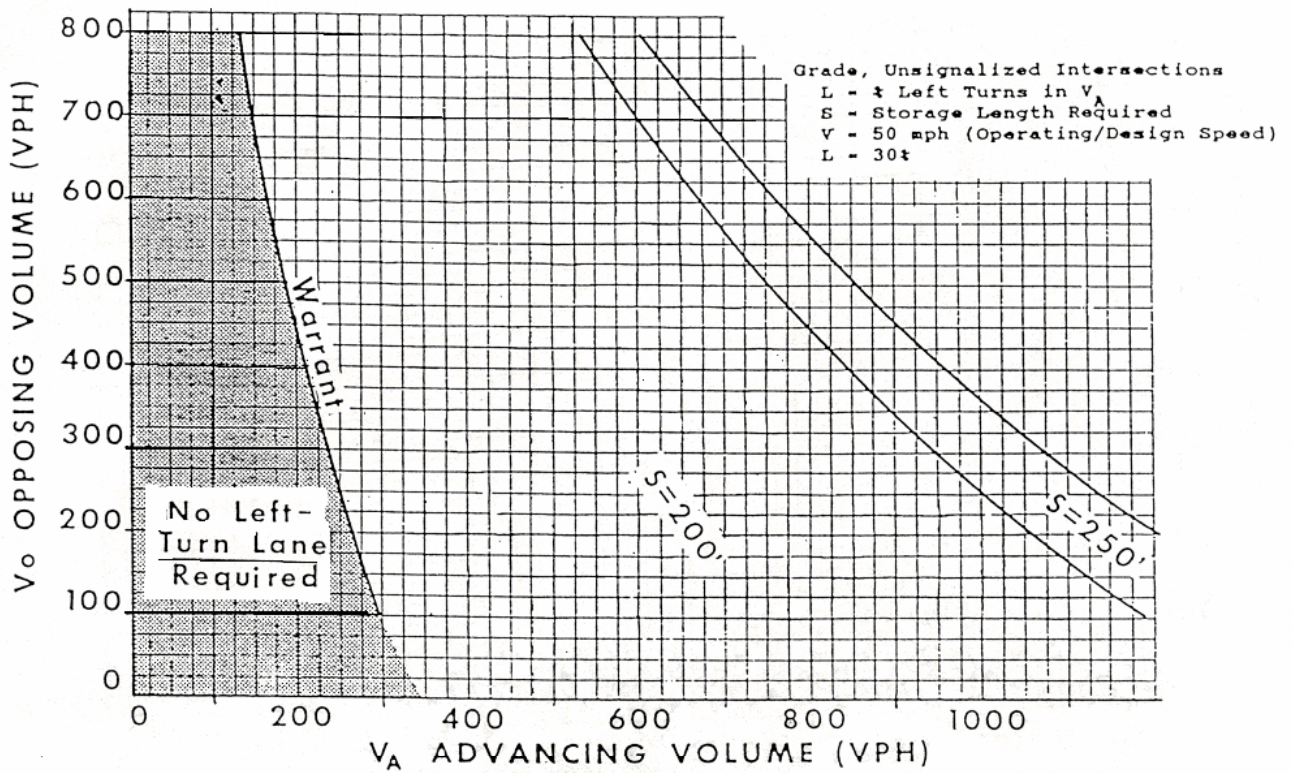

FIGURE C-1-1.12

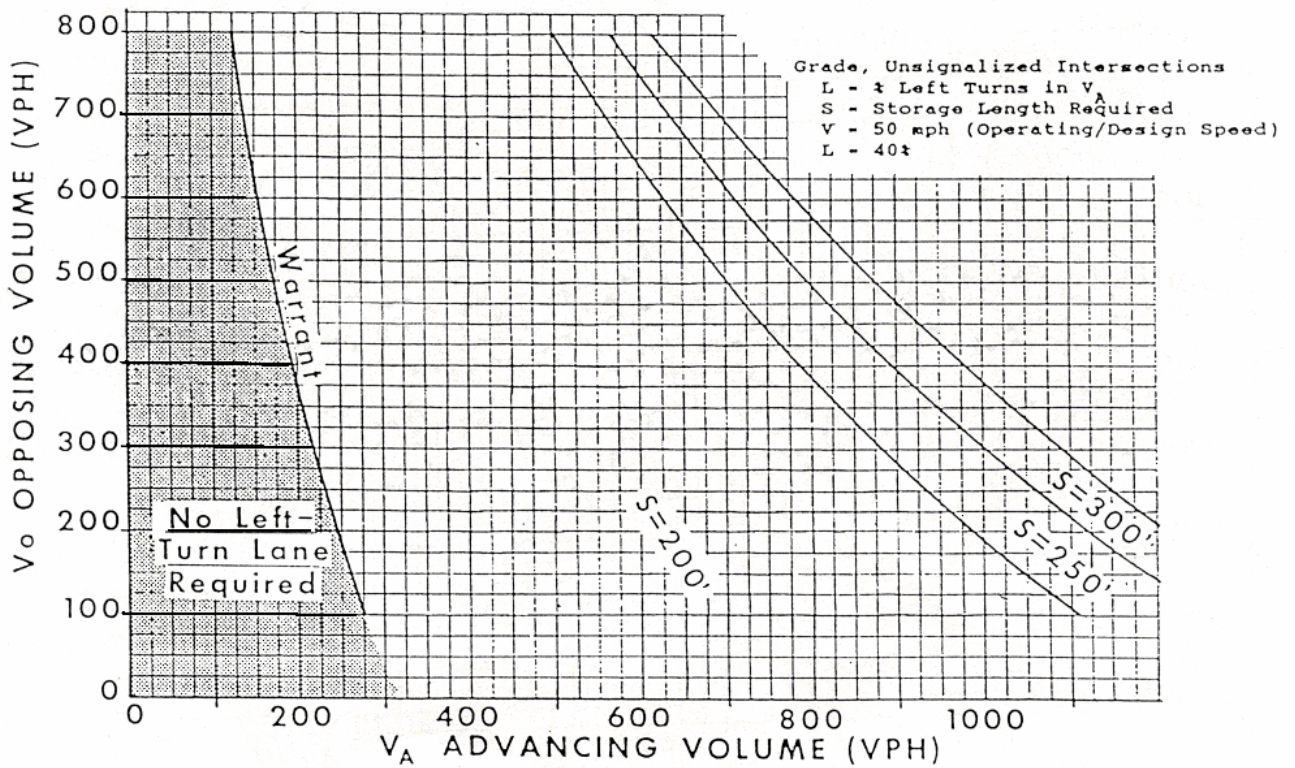

FIGURE C-1-1.13

WARRANT FOR LEFT-TURN STORAGE LANES ON TWO-LANE HIGHWAYS

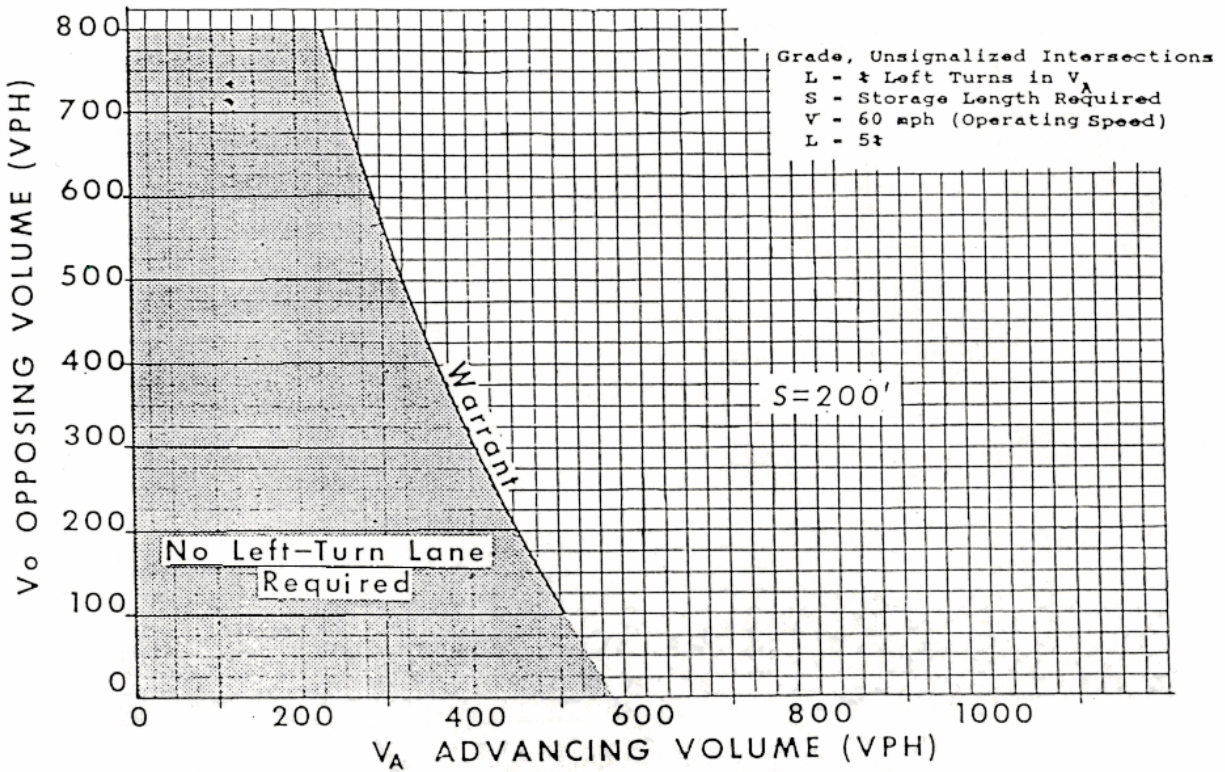

FIGURE C-1-1.14

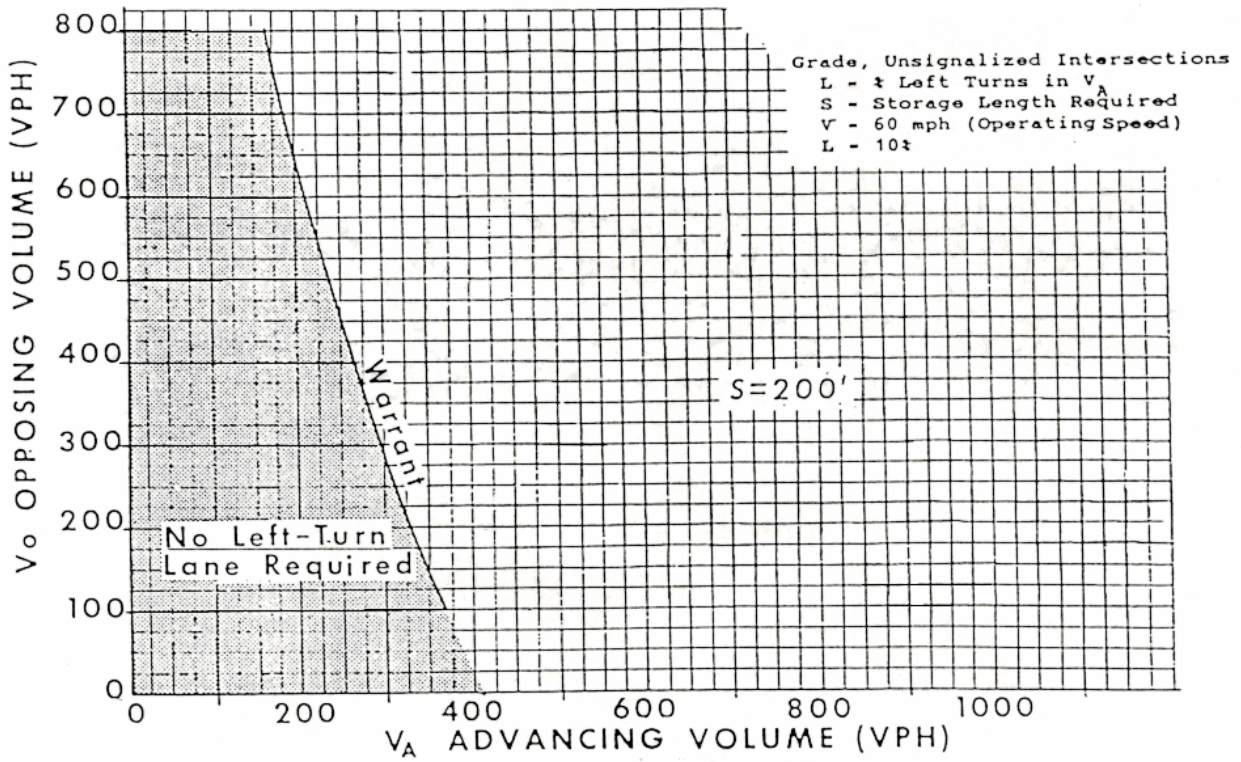

FIGURE C-1-1.15

WARRANT FOR LEFT-TURN STORAGE LANES ON TWO-LANE HIGHWAYS

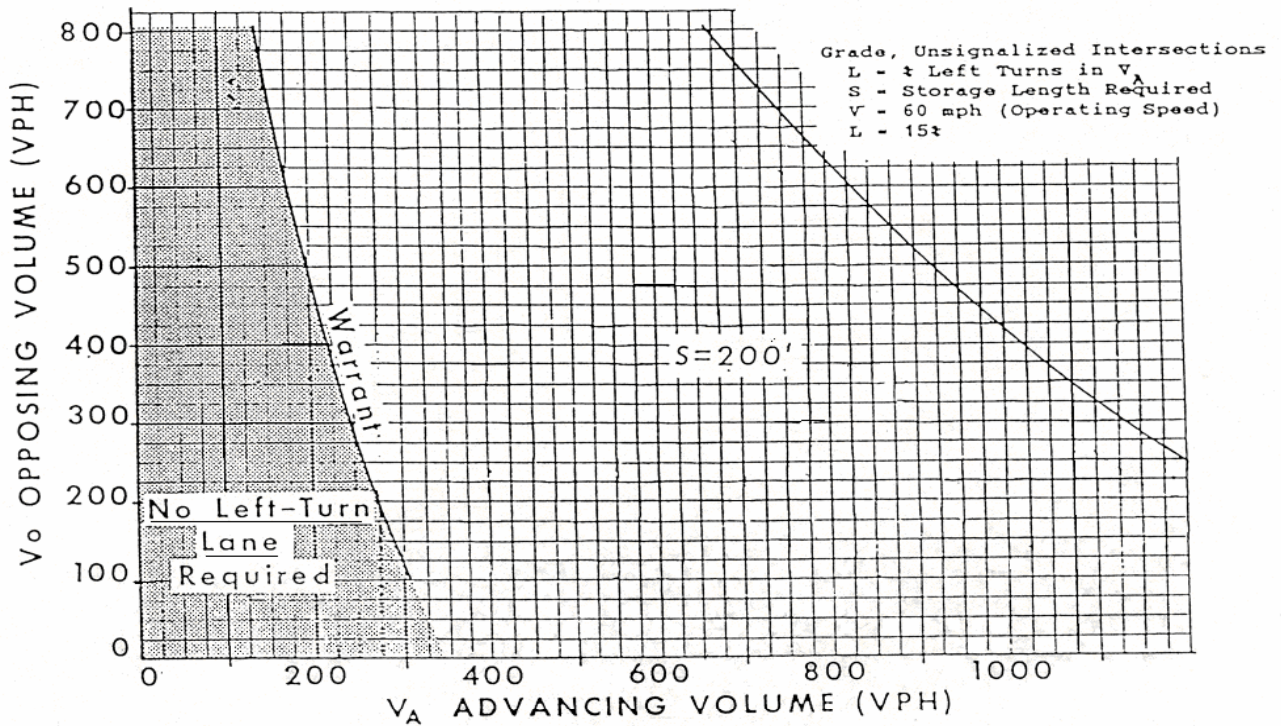

FIGURE C-1-1.16

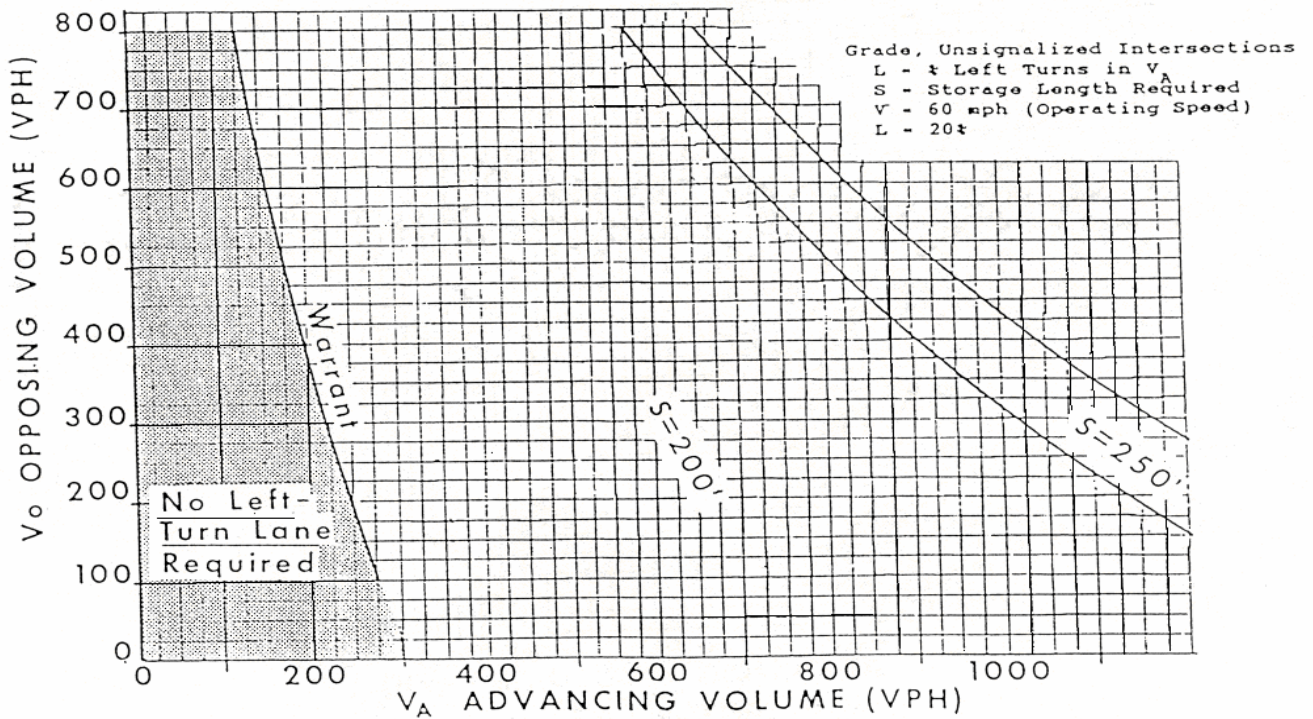

FIGURE C-1-1.17

WARRANT FOR LEFT-TURN STORAGE LANES ON TWO-LANE HIGHWAYS

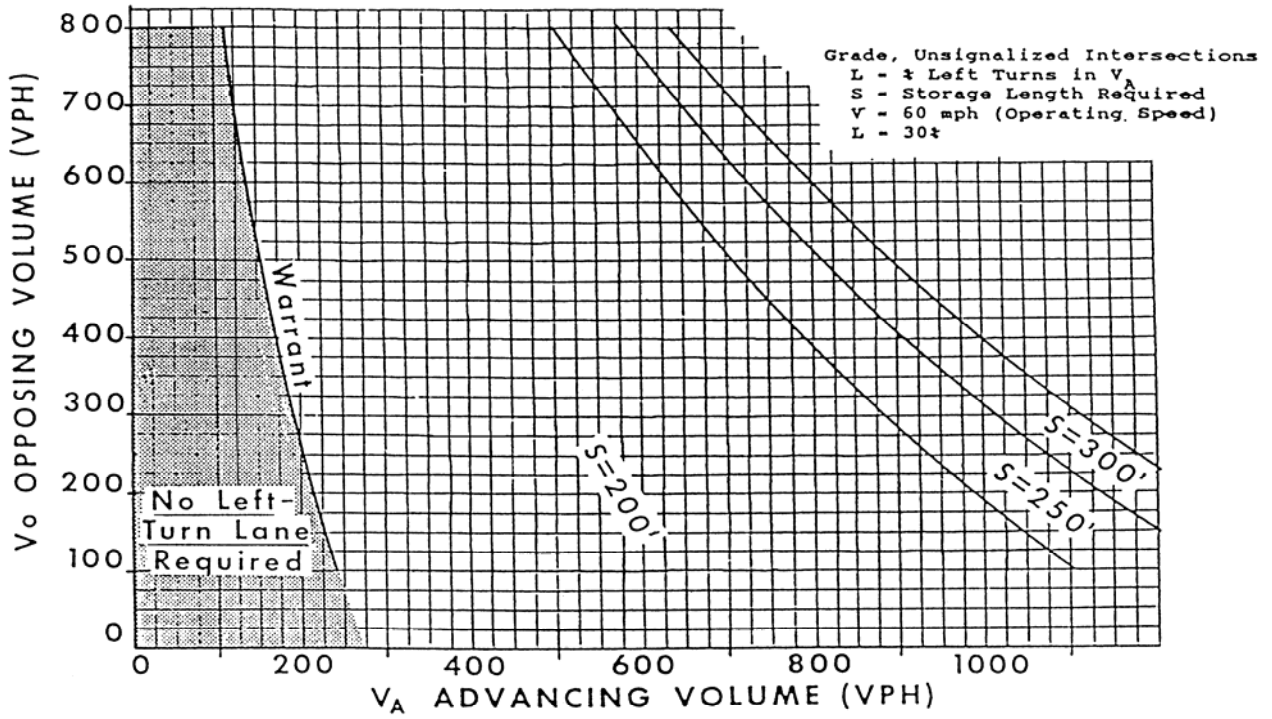

FIGURE C-1-1.18

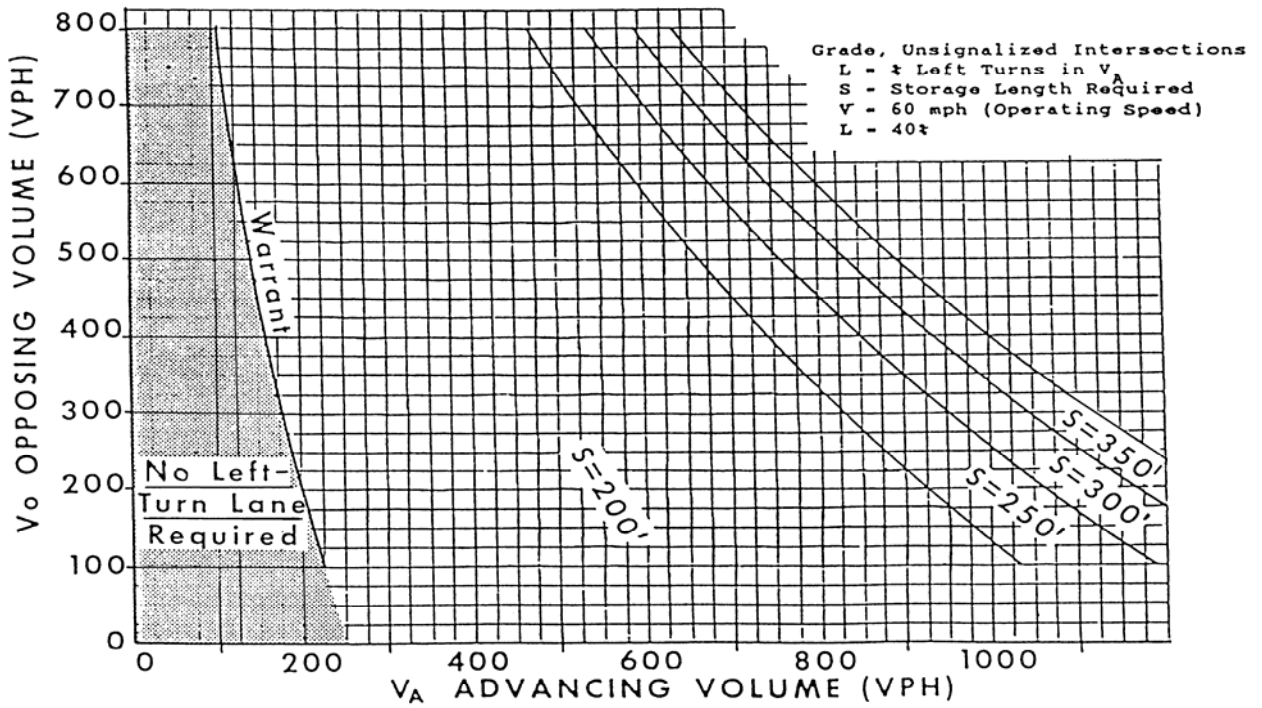

FIGURE C-1-1.19

CHART VALUE OF STORAGE LANE REQUIRED	% TL=% TRUCKS IN VPH turning left					
	0%	10%	20%	30%	40%	50%
100'	0'	25'	25'	50'	50'	50'
125'	0'	25'	25'	50'	50'	75'
150'	0'	25'	50'	50'	75'	75'
175'	0'	25'	50'	75'	75'	100'
200'	0'	25'	50'	75'	100'	100'
250'	0'	25'	50'	75'	100'	125'
300'	0'	50'	75'	100'	125'	150'
350'	0'	50'	75'	125'	150'	175'
400'	0'	50'	100'	125'	175'	200'
450'	0'	50'	100'	150'	200'	225'
500'	0'	50'	100'	150'	200'	250'

TABLE C-1-2.1 TRUCK ADJUSTMENTS*

STORAGE LENGTH TO BE ADDED TO CHART VALUES OF LEFT-TURN LANE
STORAGE LENGTHS (Length in Feet)

For additional information see Highway Research Report Number 211, Volume Warrants for the Left Turn Storage Lanes at Unsignalized Grade Intersections.

* Rev. 1/06

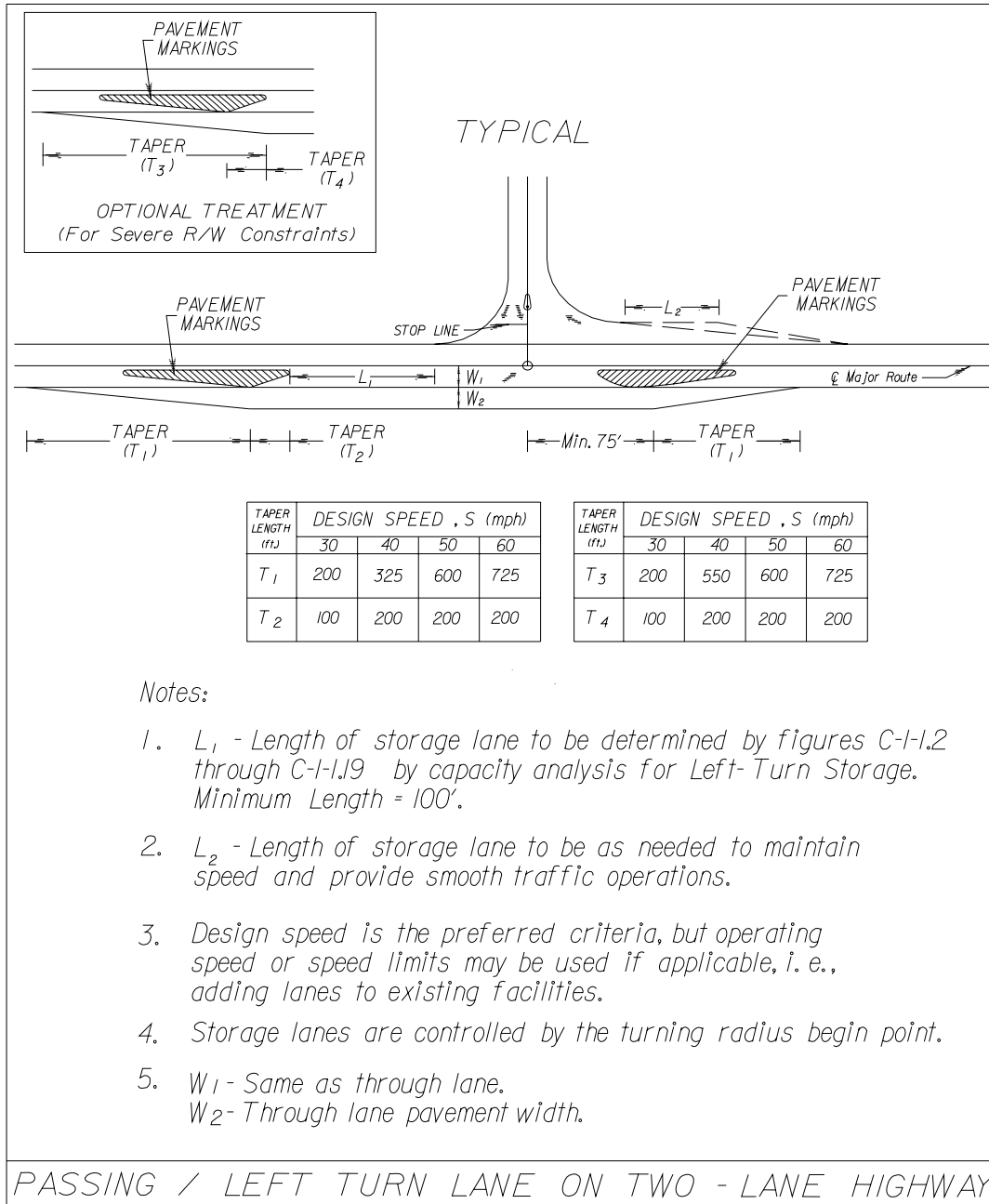

Source: 2003 MUTCD Chapter 6, Page 6C-8, Table 6C-4 (Formulas for Determining Taper Lengths). Found at the following: <http://www.virginiadot.org/business/bu-mutcd-disclaim.asp>*

FIGURE C-1-1.20

* Rev. 7/06

DOUBLE (DUAL) LEFT-TURN LANES

Double (dual) left-turn lanes (DLTL's) shall be considered when left-turn demand exceeds 300 vph, and are desirable where peak left-turn movements exceed 350 vph. DLTL's require a protected (exclusive) signal phase, a 28' minimum median width, and a width of at least 30' on the acceptance lanes (see Figure C-1-2). The length of storage should accommodate at least 1.5 times the expected vehicles making left turns per cycle based on peak 15-min. periods. When DLTL's are required, a capacity analysis of the intersection should be performed to determine what traffic controls are necessary (i.e. - signalization, separate phasing) in order to have this double left-turn lane function properly.

Continuous Left-Turn Lanes (Two way, used for left-turn lane in either direction)

Continuous two-way median left-turn lanes (C2WMLTL's) should be considered on low-speed arterial highways (25 to 45 MPH) with no heavy concentrations of left-turn traffic. C2WMLTL's also may be used where an arterial or major route must pass through a developed area having numerous street and driveway intersections, and where it is impractical to limit left turns. The minimum desirable width shall be 12' (16' maximum).

C2WMLTL's shall only be used with roadways having a maximum of 2 through lanes in each direction, and shall be shown in accordance with Figure C-1-2.1.

In commercial and industrial areas where property values are high and rights of way for wide medians are difficult to acquire, a paved flush traversable median 10' to 16' wide is the optimum design. Successful operation of a continuous left-turn lane requires adequate lane marking.

Advantages are:

- Reduced travel time.
- Improved capacity.
- Flexibility of using as temporary detour during closure of through lane.
- Does not control or limit the number of left turns.
- Minimizes interference to through traffic lanes.
- Separates opposing traffic flows by one full lane.
- Public preference (both from drivers and owners of abutting properties.)
- Reduced accident frequency, particularly rear-end collisions.

Disadvantages:

- Poor visibility (corrected by using proper delineation)

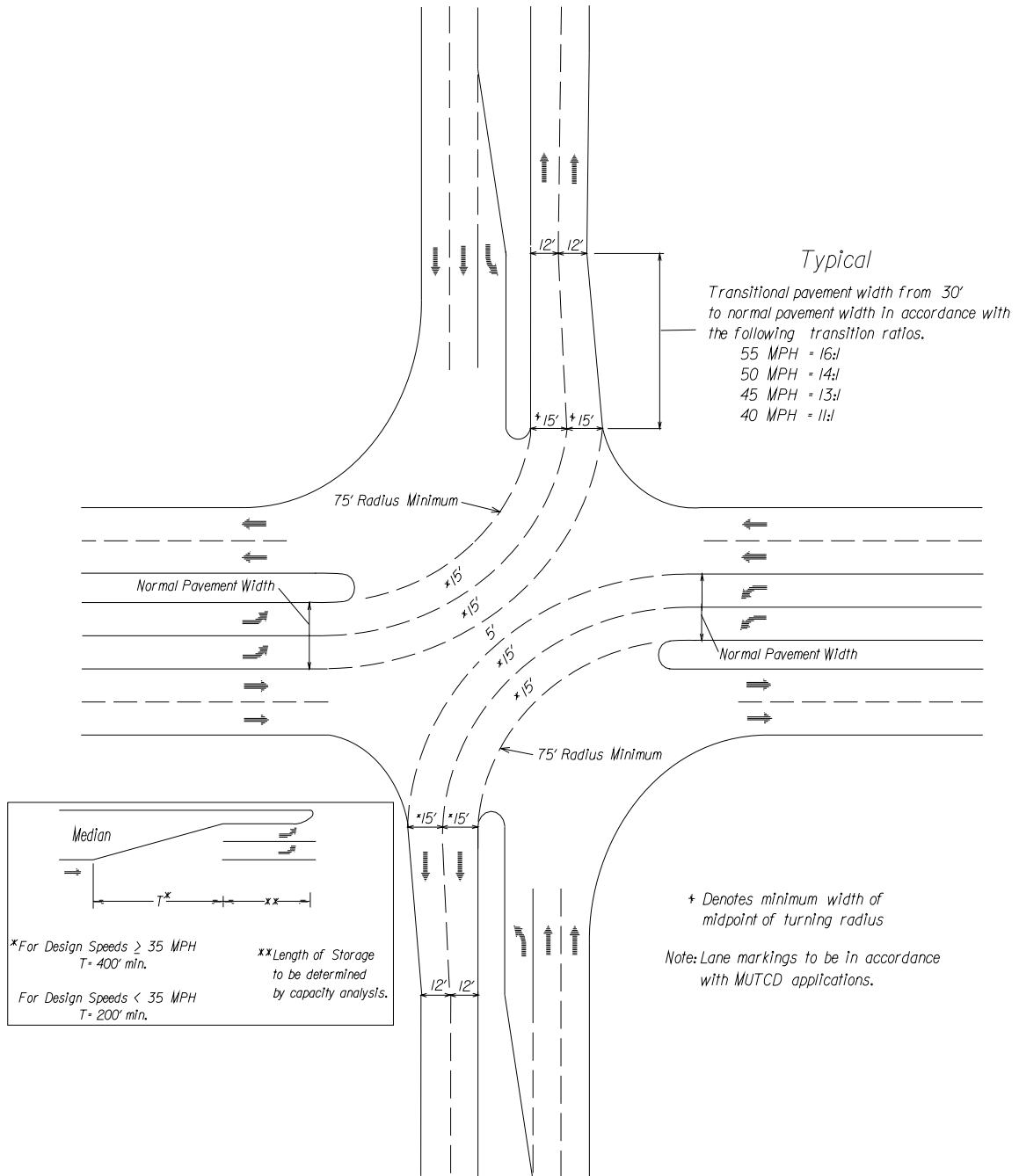
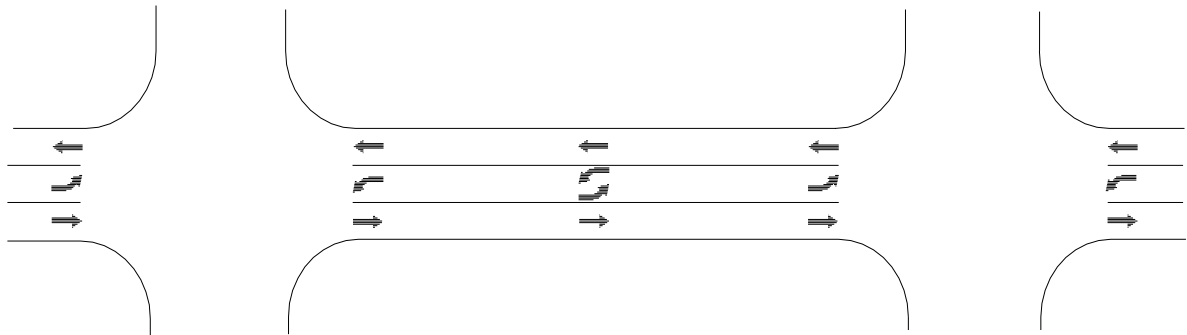
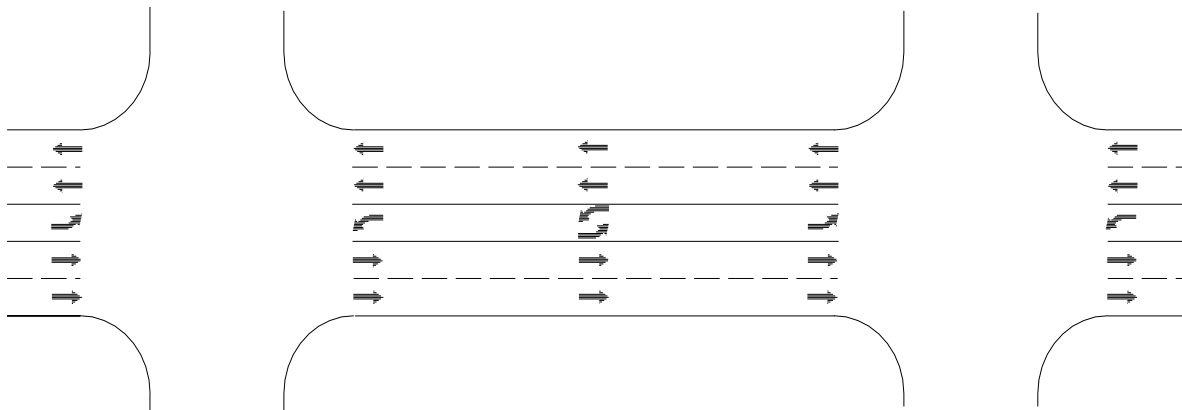

FIGURE C-1-2 DOUBLE LEFT-TURN LANES



Typical 3-Lane Configuration
W/Left Turn Provisions for the Minor Street



Typical 5-Lane Configuration
W/Left Turn Provisions for the Minor Street

FIGURE C-1-2.1 CONTINUOUS TWO-WAY MEDIAN LEFT-TURN LANES

(Lane markings to be in accordance with MUTCD application)

CROSSOVERS WITH AND WITHOUT CONNECTIONS

In commercial and industrial areas where property values are high and rights of way for wide medians are difficult to acquire, a paved flush traversable median 10' to 16' wide is the optimum design. Successful operation of a continuous left-turn lane requires adequate median openings should be designed with a minimum length of 40'. The shape of the median end should generally be symmetrical when the median width is less than 10' and the median opening length is not excessive, but the bullet nose can be effectively used to reduce the opening. For a median width of 10' or more, the bullet nose design should be used instead of a semicircular design. At 3-leg and 4-leg intersections, the length of the crossover and the shape of the median end is controlled by the width of the median and the turning radii. (See Figure C-1-3). A wide median opening can be reduced at skewed intersections by utilizing modifications of the bullet nose design. Additional information may be obtained from AASHTO's A Policy on Geometric Design of Highways and Streets (Median Openings).

INTERSECTION DESIGN

Signalized and Unsignalized:

At-grade intersections must provide adequately for anticipated turning and crossing movements. Figures C-1-4 and C-1-5 provide the designer with the basic types of intersection designs and recommendations pertinent to dimensions, radii, skews, angles, and the types of island separations, etc., to be considered. For additional information see AASHTO's A Policy on Geometric Design of Highways and Streets, Chapter 9* (Intersections). This chapter provides additional information to be considered in the design since the site conditions, alignment, grades, sight distance and the need for turning lanes and other factors enter into the type of intersection design.

Sufficient offset dimensions, pavement widths, pluses, and radii shall be shown in the plans by the designer to insure that the sign island is properly positioned.

Care should be taken in the design of four-lane roadways with intersecting two-lane roadways. If traffic conditions clearly warrant a four-lane divided design for the two-lane road at the intersection, the divided design must be constructed for a sufficient distance to allow for the approaching divided design and the subsequent stop condition ahead to be properly signed. The four-lane divided design should not be constructed unless it is clearly warranted and the approaches can be properly signed or the minor road is expected to be improved to a divided status in the near future.

* Rev. 7/07

ROUNDABOUTS:

Operational and safety characteristics of roundabouts should be compared with those of signalized and unsignalized intersections on all projects and be used if deemed appropriate. Roundabout designs should be based on Federal Highway Administration Publication Number FHWA-RD-00-067, Roundabouts: An Informational Guide at <http://www.tfhrc.gov/safety/00068/htm> and <http://www.tfhrc.gov/safety/00068.pdf>. Additional information can also be found in VDOT's Roundabout Brochure at <http://www.virginiadot.org/programs/faq-roundabouts.asp>. See Figure C-1-2.2 for Roundabout Details. When roundabout design is proposed, the Residency Administrator should consult the District Location & Design Engineer.*

THE APPROVAL PROCESS FOR ROUNDABOUTS IS AS FOLLOWS:

Existing and Proposed Subdivisions- The District may review and approve.

Secondary System- District may approve up to a traffic design volume of 10,000 VPD. Roundabout designs in which the counts are beyond this volume should be submitted to the Central Office Roundabout Review Committee for review. The committee will make recommendations to the State Location and Design Engineer for approval or disapproval. Appeals of the State Location and Design Engineer decision will go to the Chief Engineer for resolution. (When a District receives a request for a roundabout from an outside entity, and the design volume is under 10,000 VPD but desires Roundabout Committee review and input. The submittal may be sent to the State Location and Design Engineer. It will be reviewed and comments and/or recommendations will be returned in a timely manner.)

Primary or Urban System- The District will submit roundabout designs to the Central Office Roundabout Committee for review. The approval and appeals will be the same as used above for these roadway systems with one exception, urban systems will require approval of the Local Assistance Division Administrator as well as the State Location and Design Engineer.

The process listed above applies to:

- Roundabouts proposed through 6 year construction program.
- Roundabouts proposed during road safety improvements and/or upgrades.
- Roundabouts proposed by Counties, Localities, Consultants and Developers.

The submittal should contain and depict the following criteria:

- Approach Grades and sight distances.
- Inscribed diameter of circulatory roadway.
- Design vehicle (WB-50 or WB-67).
- Apron width, circulatory lane width and approach lane widths.
- Approach lane deflection and length of splitter islands.

* Rev. 7/06

- Pedestrian crossing locations.
- Pavement markings.
- Signing.
- Roadway Lighting (desirable).
- Nearest entrance locations and nature of property use.
- Initial or present and projected design year traffic count on all approaches.
- Turning movements for all directions.
- SIDRA Analysis on all approaches showing peak hour LOS in design year.
- Autoturn results showing off tracking of Design Vehicle.
- Is this facility designed as a bicycle Route?
- Are their accommodations made to bicyclists?

If, for some reason, the District does not have capability to run the subject computer programs, the Roundabout Committee can provide assistance upon request.*

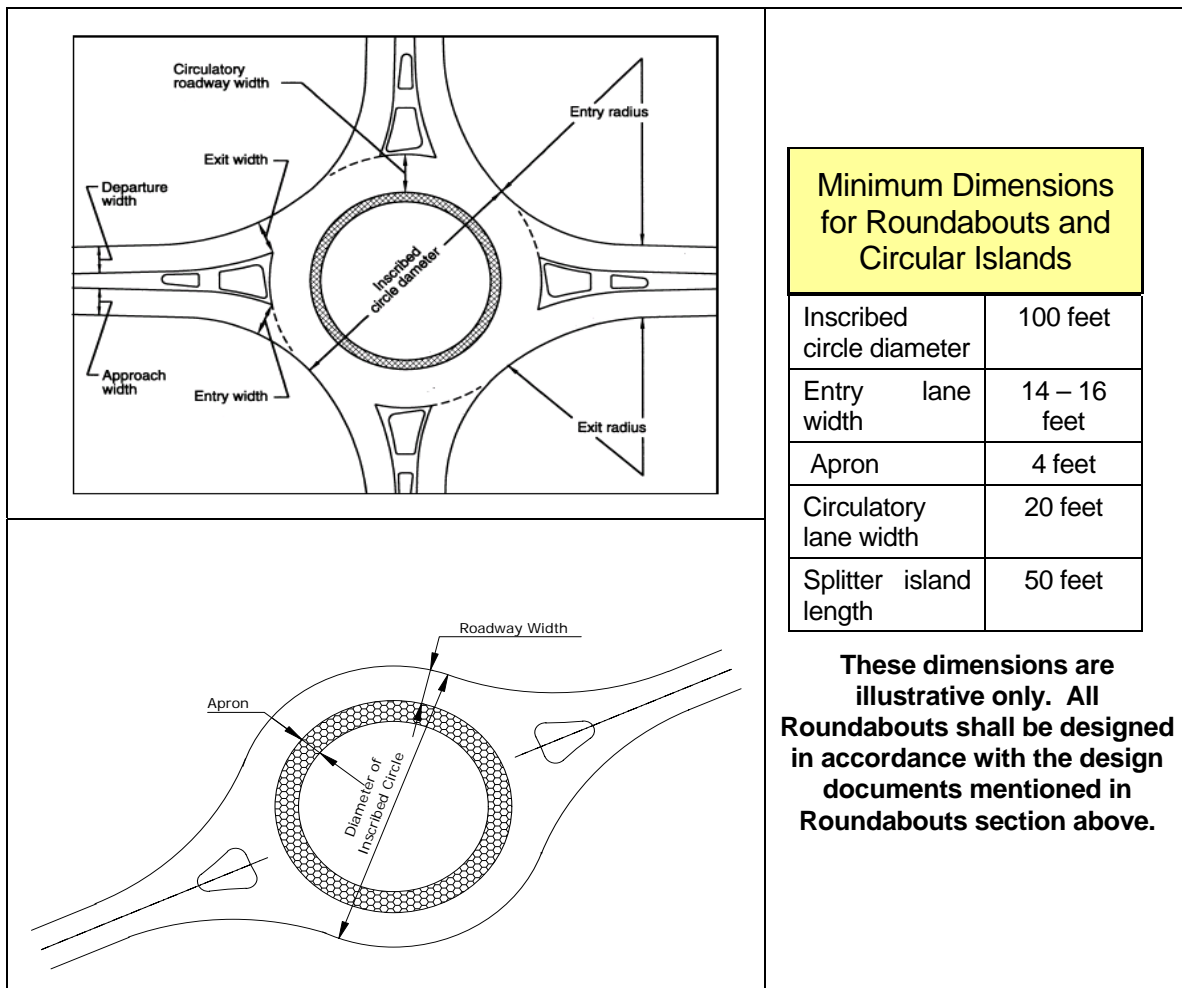

FIGURE C-1-2.2 ROUNDABOUT DETAILS

* Rev. 7/06

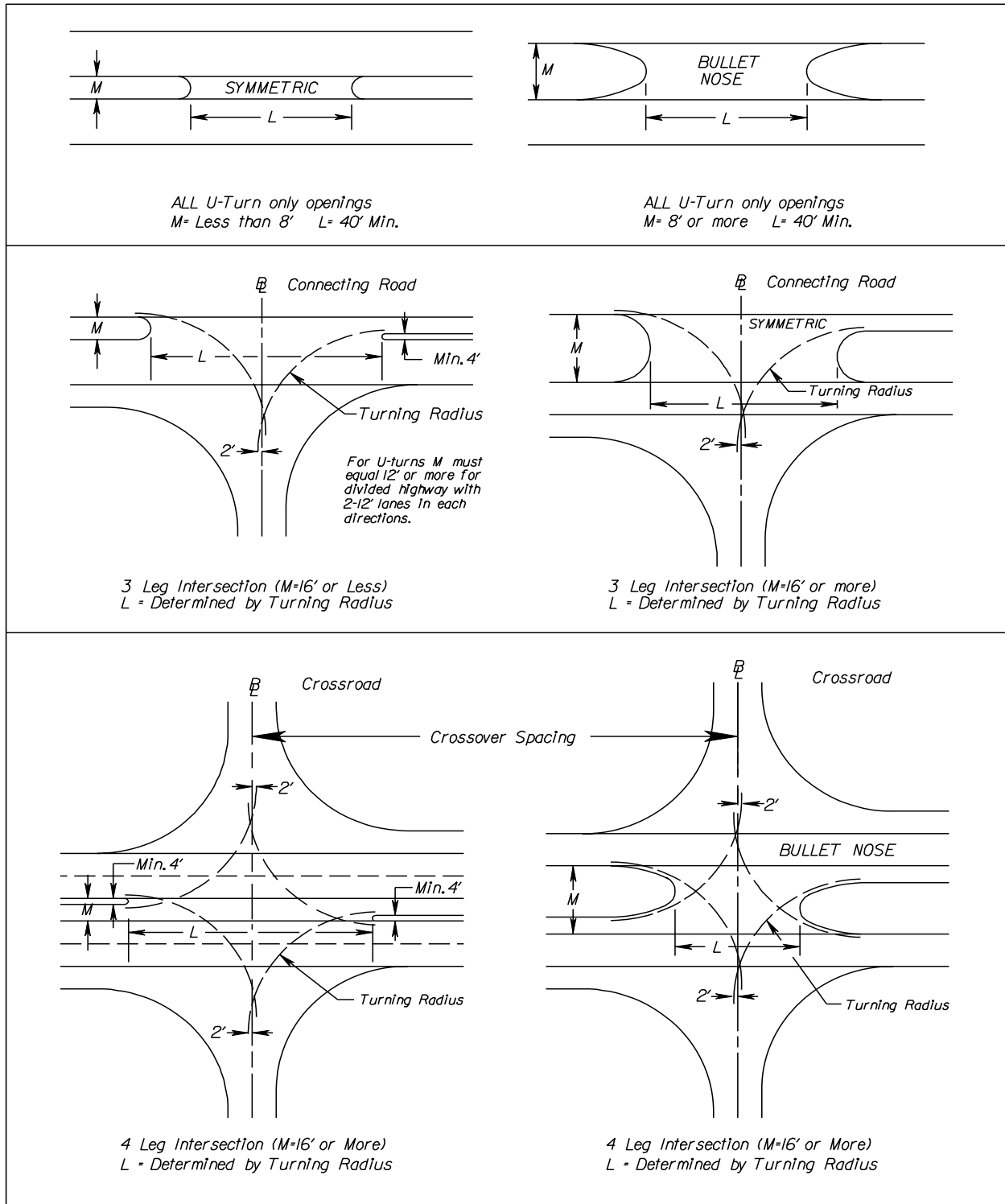

FIGURE C-1-3 CROSSOVERS WITH AND WITHOUT CONNECTIONS*

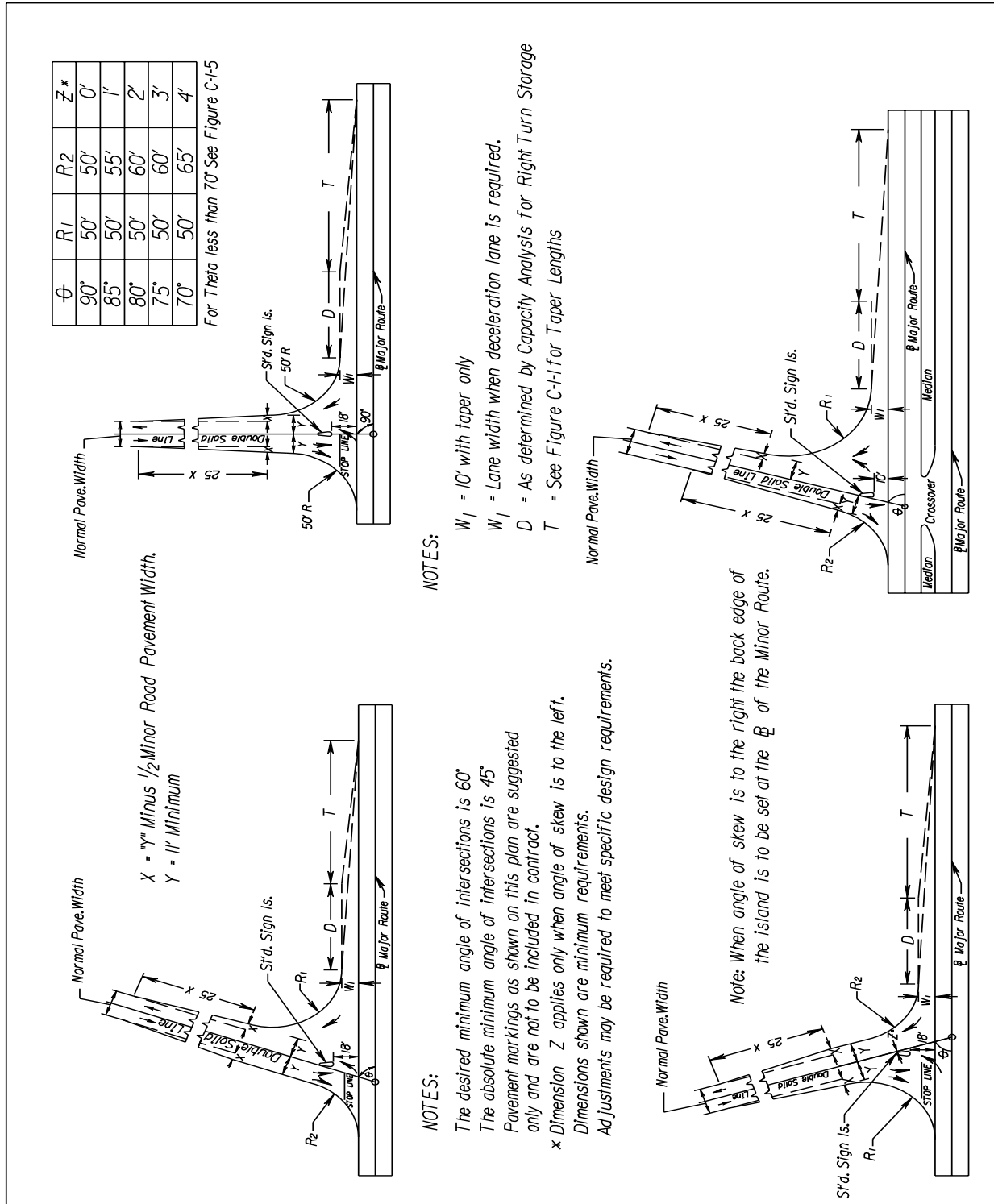

FIGURE C-1-4 INTERSECTION DESIGN*

* Rev. 7/07

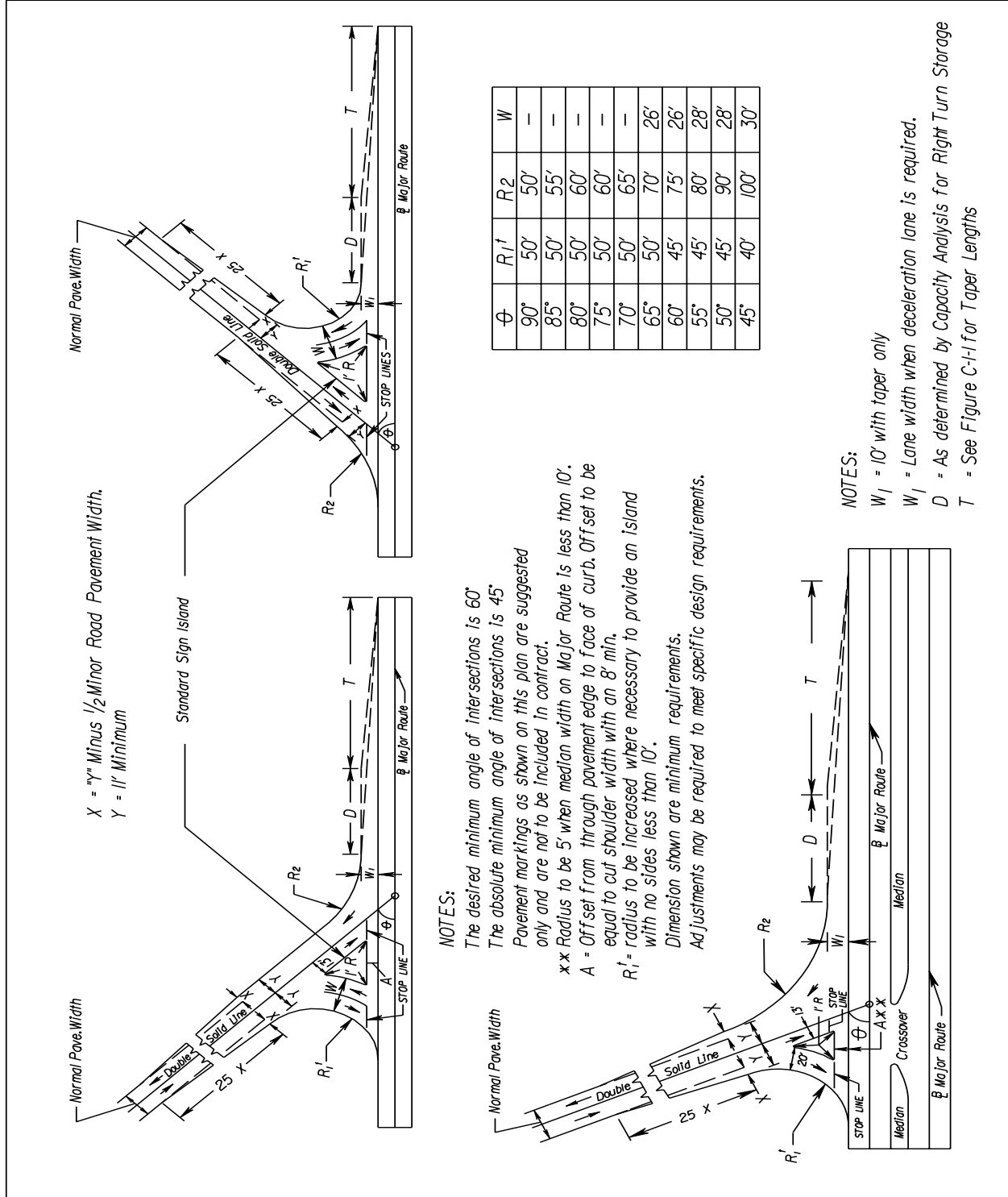

FIGURE C-1-5 INTERSECTION DESIGN*

* Rev. 7/07

SIGHT DISTANCE

Sight distances exceeding those shown in Table C-1-3 should be used as the basis for design wherever practical. When a highway is on a grade, the equation for braking distance should be modified in accordance with AASHTO's A Policy on Geometric Design of Highways and Streets.

The following tables are to be used in developing plans for all roadway systems:

Height of Eye 3.5'							Height of Object 2'			
Design Speed**	25	30	35	40	45	50	55	60	65	70
MINIMUM SIGHT DISTANCE	155	200	250	305	360	425	495	570	645	730
MINIMUM K VALUE FOR:										
CREST VERTICAL CURVES	12	19	29	44	61	84	114	151	193	247
SAG VERTICAL CURVES	26	37	49	64	79	96	115	136	157	181

TABLE C-1-3 STOPPING SIGHT DISTANCE

K Value is a coefficient by which the algebraic difference in grade may be multiplied to determine the length in feet of the vertical curve that will provide minimum sight distance.

Height of Eye 3.5'				Height of Object 3.5'		
Design Speed**	30	40	50	60	65	70
MINIMUM SIGHT DISTANCE	1090	1470	1835	2135	2285	2480

TABLE C-1-4 PASSING SIGHT DISTANCE

** For all tables, if the Design Speed is unknown, it may be assumed to be the posted speed limit unless the operating speed is lower at that point.

Each designer is to review the plans to determine if passing zones have been provided in the design to the best practical extent. The generally accepted method of checking passing sight distance is graphically by the use of a straight edge along the profile while comparing same to the horizontal alignment. These minimum passing sight distances for design are not to be confused with other distances used as warrants for placing no-passing zone pavement stripes on completed highways.*

* Rev. 1/06

Such values as shown in the Manual on Uniform Traffic Control Devices are substantially less than design distances and are derived for traffic operating control needs which are based on assumptions different from the passing sight distance used for highway design.

Height of Eye 3.5'	Height of Object 3.5'										
Design Speed (mph)**	20	25	30	35	40	45	50	55	60	65	70
2 Lane Major Road	225	280	335	390	445	500	555	610	665	720	775
4 Lane Major Road (Undivided)	240	295	355	415	475	530	590	650	710	765	825
4 Lane Major Road (Divided – 18' median)	260	325	390	455	520	580	645	710	775	840	905

TABLE C-1-5

**INTERSECTION* SIGHT DISTANCES ALONG MAJOR ROAD AT
INTERSECTION WITH MINOR ROADS, CROSSOVERS AND COMMERCIAL
ENTRANCES**

**For all tables, if the Design Speed is unknown, it may be assumed to be the posted speed limit unless the operating speed is lower at that point.

For major roadways of more than four lanes, large truck volumes on a minor road or crossover, or median widths over 60', see AASHTO's A Policy on Geometric Design of Highways and Streets.

The designer must check each intersection to insure that these values are obtained. Any deficiency which cannot be corrected is to be brought to the attention of the State Location and Design Engineer.

On a typical two-lane road horizontal curve there are numerous objects that restrict sight distance such as, cut slopes, buildings, vegetation, vehicles, etc. It is very possible to have sight distance in the winter and not in the spring or summer due to the growth of vegetation.

* Rev 1/06

These obstructions should be considered when reviewing commercial entrances. A divided highway can have similar problems. It is very important to obtain adequate commercial entrance sight distance from the entrance as well as the left turn position into the entrance. A design exception must be granted by the State Location and Design Engineer (or designee), and if applicable, the Federal Highway Administration for deviating from required sight distance standards.

The term "Major Road" refers to the major of the intersecting roads.

Intersection Sight Distance values in TABLE C-1-5 permit a vehicle stopped on minor road or crossover, to cross the major road safely or merge safely in the case of turns.

For the minimum lengths of vertical curves for the recommended stopping sight distance for each design speed, and corresponding "K" values, see AASHTO "Green Book".*

* Rev. 1/07

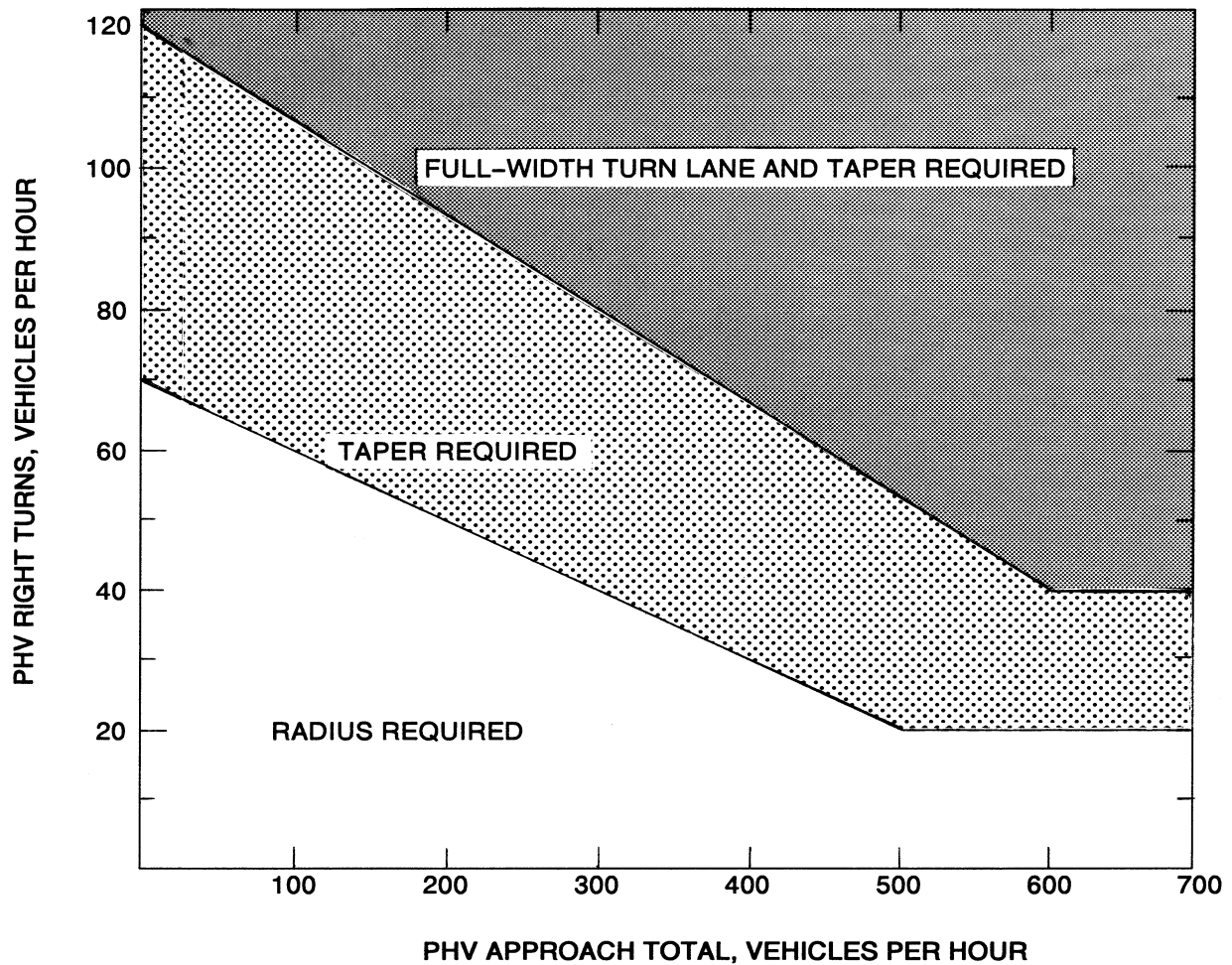

LEGEND

PHV - Peak Hour Volume (also Design Hourly Volume equivalent)

Adjustment for Right Turns

For posted speeds at or under 70 km/h (45 mph), PHV right turns > 40, and PHV total < 300.

Adjusted right turns - PHV Right Turns - 20

If PHV is not known use formula: $PHV = ADT \times K \times D$

K = the percent of AADT occurring in the peak hour

D = the percent of traffic in the peak direction of flow

Note: An average of 11% for K x D will suffice.

FIGURE C-1-8 GUIDELINES FOR RIGHT TURN TREATMENT (2-LANE HIGHWAY)

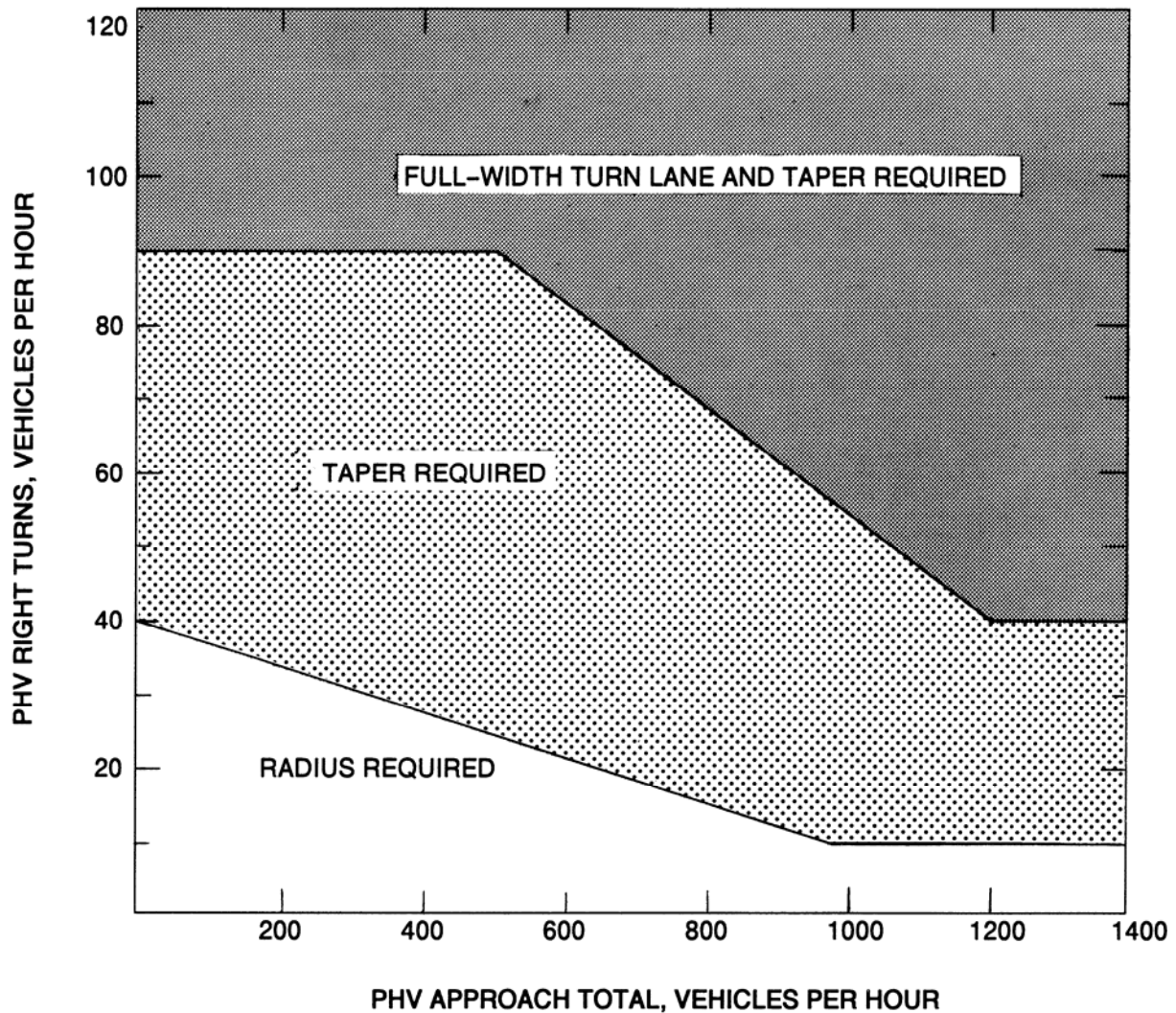

LEGEND

PHV- - Peak Hour Volume (also Design Hourly Volume equivalent)

Adjustment for Right Turns

If PHV is not known use formula: $PHV = ADT \times K \times D$

K = the percent of AADT occurring in the peak hour

D = the percent of traffic in the peak direction of flow

Note: An average of 11% for K x D will suffice.

FIGURE C-1-9 GUIDELINES FOR RIGHT TURN TREATMENT (4-LANE HIGHWAY)

RIGHT TURN LANES

In general, when right-turn volumes are higher than 300 vehicles per hour (vph) and adjacent mainline volume is also higher than 300 vph, an exclusive right-turn lane should be considered. Double exclusive right-turn lanes may be provided when the right-turn volume is higher than 350 vph. Safety implications associated with pedestrians and bicyclists should always be considered.*

These guidelines are to be used as an aid in selecting appropriate treatments for right turn movements. (Reference material attained from Virginia Highway and Transportation Research Council report "The Development of Criteria For the Treatment of Right Turn Movements on Rural Roads" dated March 1981.)

1. Number of Lanes - Guidelines are differentiated on the basis of the number of lanes on the major roadway. Refer to Figure C-1-8 for 2-lane roadways and Figure C-1-9 for 4-lane roadways. The minor roadway is a 2-lane road. Discussion on both figures is provided. All volumes refer to the volumes on the approach under consideration for right turn treatments.
2. Radius Treatment - Figure C-1-8 contains guidelines for right turn treatment on 2-lane roadways. The predominant treatment for 2-lane roadways is the radius. Arterial roadways tend to carry higher volumes of traffic traveling at higher speeds as compared to local roadways. The traffic on local roadways tends to include a higher number and percentage of right-turning vehicles than that on arterials. An adjustment is needed to permit local roadways to handle more right turns (at lower speeds) compared to arterial roads. The following adjustment is made for posted speeds at or under 45 mph (70 km/h).

Adjusted Number of Right Turns = Number of Right Turns - 20 for number right turns > 40 and total volume < 300

For example, let total volume = 200 vph, right turn volume = 70 vph and posted speed = 40 mph (65 km/h) Then adjusted number of right turns - $r = 70 - 20 = 50$. Therefore, entering Figure C-1-8 with a total volume 200 vph and $r=50$ vph, a radius is recommended as the right turn treatment.

Taper treatment - A taper is recommended for a primary route with a right turn, unless the volume conditions require a full-width turn lane or the percentage of right-turning vehicles make up less than 10% of the total traffic, in which case a radius is suggested.

3. Figure C-1-9 contains guidelines for 4-lane roadways. Four-lane roadways tend to have a taper or full-width lane to facilitate right turn movements. Many of these roads are divided highways with a speed limit of 55 mph (90 km/h) .
4. Other factors - The selection of a treatment for right turn movements may be influenced by sight distance, availability of right of way, grade, and angle of turn. Although these factors are not incorporated in the guidelines, they should be

* Rev. 7/06

given consideration. The guidelines should be used unless the Engineer determines that special treatment is necessary due to other factors.

5. Data collection procedures - In order to employ these guidelines, peak hour volume data must be obtained from the Traffic Engineering* Division or Transportation and Mobility Planning Division, as appropriate.

Note: Figure C-1-1 should also be used for right turn storage and taper lengths. However, a capacity analysis should be performed for intersection capacity and signalization requirements.

ENTRANCES

Title 33.1-89 of the Code of Virginia, as amended, requires that projects have the alignment, profile, and grade of private entrances shown on plans.

This information is to be shown as follows:

1. When the proposed entrance is to be placed in the same location as the existing entrance, no alignment will be shown. The proposed entrance will be shown graphically.
2. Where a proposed entrance is to be on a location different from the existing, the proposed location will be shown graphically on the field inspection plans. After the field inspection party has reviewed the proposed location, the Right of Way and Utilities Division will contract the property owner and determine that the proposed location is satisfactory or that the property owner desires some other location. The designer will then request the centerline and profile to be run by the survey party when this cannot be secured from existing notes. This alignment is to be shown on the plans.
3. A profile and proposed grade is to be shown for each entrance where it is necessary to regrade on existing or new location. The survey party runs a profile along every existing entrance using a data collector and converting the information for placement into a graphics file. The profile is generally run along the center of the existing entrance, although usually no alignment is taken. The proposed grade can be a spline grade with an approximate percent of grade shown. The proposed grade will begin at the edge of shoulder; back of curb; or back of sidewalk, sidewalk space, or bikeway whichever is the outermost permanent construction. If it is necessary to use some other beginning point, it should be identified on the profile. It is desirable that projects with a large number of entrances contain a separate profile sheet or sheets devoted to entrances.

* Rev. 1/07

4. A note is to be included on the general notes sheet as follows: "When no baseline alignment is shown for a proposed entrance, the entrance is to be constructed in the same location as the existing entrance."
5. The above information does not apply to "No Plan" Projects.*

Title 33.1-199 of the Code of Virginia, as amended, provides that any entrance disturbed in the repair or construction of a highway be replaced. This entrance is to be left in the same condition as it was prior to such repair or improvement.

1. Whenever plans have been prepared for a proposed improvement and submitted to the district for field inspection, the plans will show the entrances in place as called for by the engineering information at the time the plans were prepared. The field inspection team shall make a close inspection of all entrances on the project and provisions are to be made to replace such entrances.
2. In reviewing the plans, there may be instances where a landowner now has access to his property by reason of the fact that he is able to drive from the highway surface to this adjoining property, particularly in farming operations, in order to obtain access to various fields within the farm. This must be carefully studied and, if the farm is so arranged that this is found to be true, the provisions are to be made to provide field entrances as conditions would require.
3. No additional entrances are to be called for or shown on the plans.
4. The right of way is to be appraised and acquired in accordance with the approved plans and the entrances that are shown thereon. (Should it be discovered at the appraising or negotiating stage that an existing entrance has been overlooked or added by the owner since the time of field inspection, then, of course, this entrance will be replaced.) There will, of course, be instances when the owner requests the construction of an entrance to a property where no access exists or for the construction of an additional entrance. When this occurs, the owner's request can be complied with if it is determined that construction of the entrance is economically justified and the District Administrator and District Traffic Engineer give their approval for the construction thereof.
5. The applicable details shown as CADD Cell "PCENTR" at <http://www.extranet.vdot.state.va.us/locdes/caddman/html/frameset.htm> are to be placed on the typical section sheet.

* Rev. 1/07

SAFETY REST AREAS

Design guides for safety rest areas are shown on Figure C-1-11 and Figure C-1-12. Rest areas along the roadways are functional and desirable elements on heavily traveled roads and on those carrying recreational traffic. They are a part of the complete highway development provided for the safety and convenience of the roadway users. The design and location of rest areas depends much on the character and volume of traffic, type of highway and adjacent land use and should consider the scenic quality of the area, accessibility and adaptability to development. Other essential considerations include an adequate source of water and a means to treat and/or properly dispose of sewage. Site plans should be developed by the use of a comprehensive site planning process that should include the location of ramps, parking areas, buildings, picnic areas, water supply, sewage treatment facilities and maintenance areas. The objective is to give maximum weight to the appropriateness of the site rather than adherence to constant distance or driving time between sites.

Principles of ramp terminal design apply generally at the points of access to or from these areas. The designer is to refer to [IIM LD- 20](#) in the design of ramp terminal and speed change lane criteria. Figures C-1-13 and C-1-14 are to be used as guides for the selection of the parking space arrangement for cars and trucks. Parking spaces and access aisles shall be designed with surface slopes not to exceed 1:50 (2%) in all directions.

PARKING SPACES

Where parking spaces are provided, accessible spaces for persons with mobility impairments should comply with the following table:

Total Parking in Lot	Required Minimum Number Accessible Spaces
1 to 25	1
26 to 50	2
51 to 75	3
76 to 100	4
101 to 150	5
51 to 200	6
201 to 300	7
301 to 400	8
401 to 500	9
501 to 1000	2 percent of total
1001 and over	20 plus 1 for each 100 over 1000

Source: The most recent Americans with Disabilities Act Accessibility Guidelines (ADAAG).*

Accessible parking spaces shall be at least 96 in. (2440 mm) wide. Access aisles adjacent to accessible spaces shall be 60 in. (1525 mm) wide minimum. One in every eight accessible spaces, but not less than one, shall be served by an access aisle 96 in. (2440 mm) wide minimum and shall be designated "van accessible". Two accessible parking spaces may share a common access aisle (see Figure C-1-10.1).

The "Universal Parking Space Design" is an acceptable alternative to providing a percentage of spaces with a 96 in. (2440 mm) wide aisle. Under this design all accessible spaces are a minimum of 132 in. (3350 mm) wide with 60 in. (1525 mm) wide access aisles. Since all spaces using this design are van accessible, no additional signage is needed to denote which spaces will accommodate vans. This design allows vehicles to park to one side or the other within the 132 in. 3350 mm space.

Accessible parking spaces for persons with mobility impairments are to be located and designed to provide the shortest possible route to rest area facilities. If there are curbs between the access aisle and parking perimeter, then curb cut ramps, Standard CG-12, are to be provided. The Traffic Engineering Division and Environmental Division should be contacted to coordinate the signing and placement of curb cuts. Figure C-1-10.1 is to be used to provide ample space for the accessible loading area.

* Rev. 1/07

Parked vehicle overhangs shall not reduce the clear width of an accessible route. Accessible parking spaces shall be designated as reserved by a sign showing the symbol of accessibility. Van accessible spaces shall have an additional sign "Van-Accessible" mounted below the symbol of accessibility. Such signs shall be located so they cannot be obscured by a vehicle parked in the space. Provide minimum vertical clearance of 114 in. (2895 mm) at accessible passenger loading zones and along at least one vehicle access route to such areas from site entrance(s) and exit(s).

ACCESSIBLE PARKING AND PASSENGER LOADING ZONES

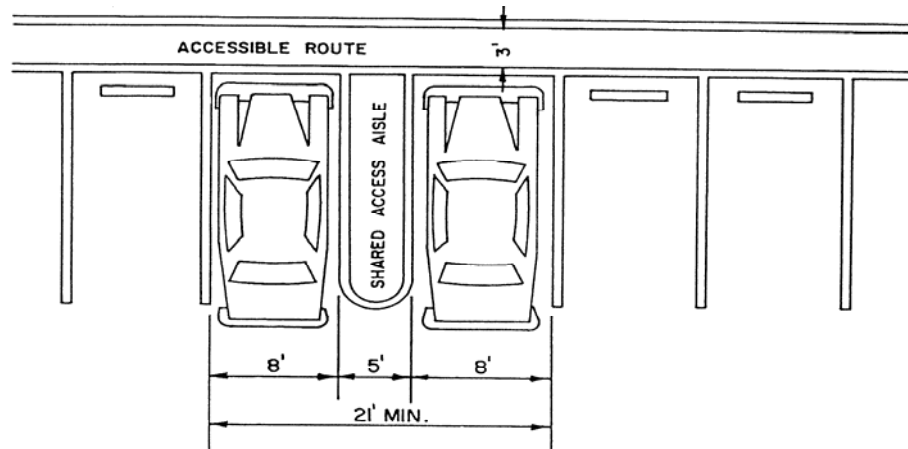

MINIMUM DIMENSIONS FOR ACCESSIBLE PARKING

** Universal Parking Spaces
11' wide may be used.
See instructions for "Parking
Spaces" to determine number
of accessible spaces required.

* 8 min. adjacent to spaces
for vans designed for handi-
capped persons.

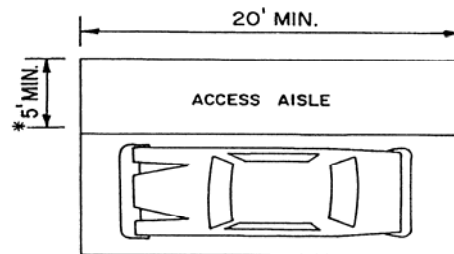

ACCESS AISLE FOR ACCESSIBLE LOADING ZONES

Source: The most recent Americans with Disabilities Act Accessibility Guidelines (ADAAG).*

NOTES:

LOCATION: Parking spaces for persons with mobility impairments and accessible passenger loading zones that serve a particular building shall be located on the shortest possible accessible circulation route to an accessible entrance of the building. In separate parking structures or lots that do not serve a particular building, accessible parking spaces shall be located on the shortest possible circulation route to an accessible pedestrian entrance of the parking facility.

PASSENGER LOADING ZONES: If there are curbs between the access aisle and the vehicle pull-up space, then a Standard CG-12 Curb Ramp shall be provided.

FIGURE C-1-10.1 DESIGNS FOR ACCESSIBLE PARKING SPACES

* Rev. 1/07

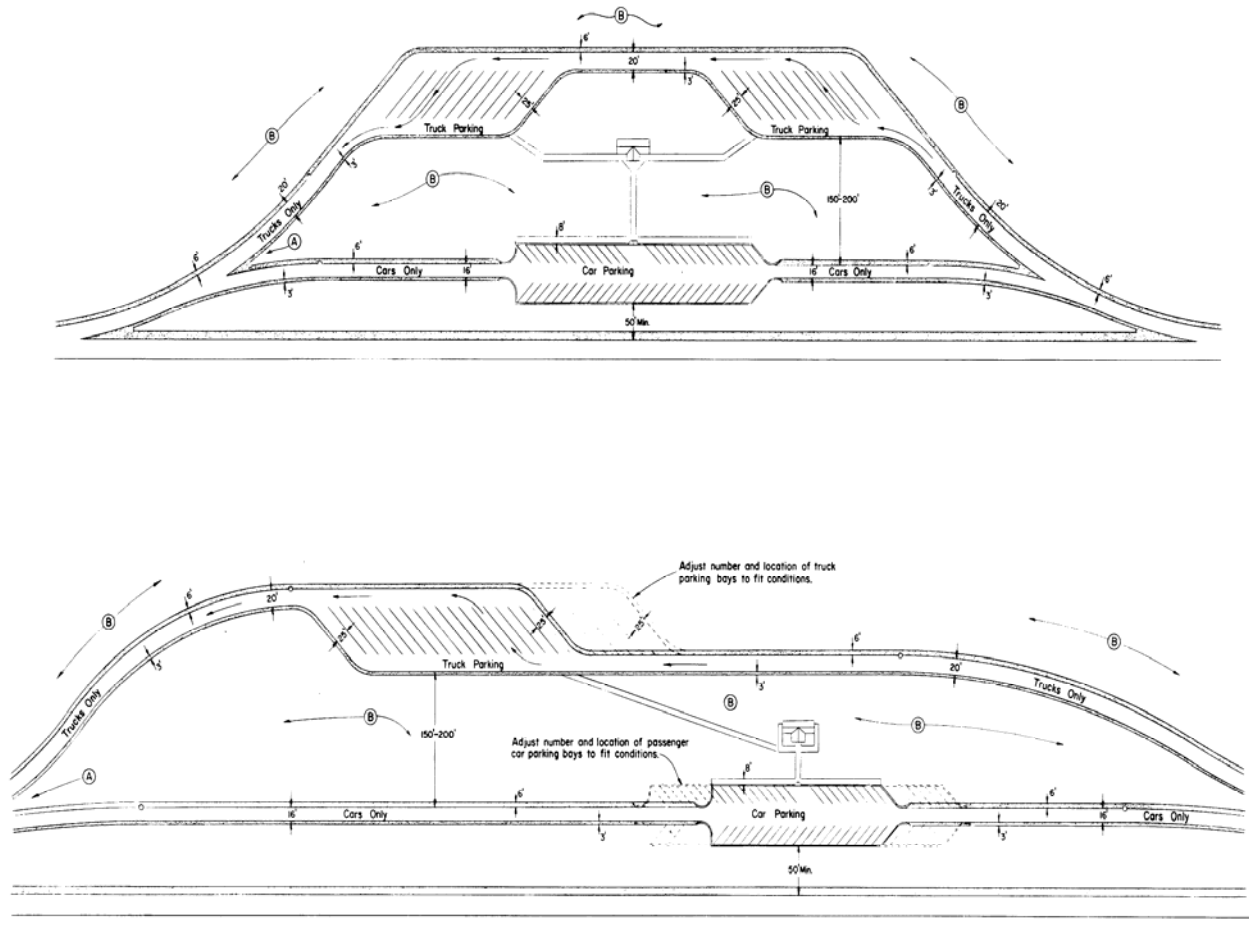

A. Denotes areas to be cleared, grubbed, graded, topsoiled, and seeded.

B. Denotes areas NOT to be cleared and grubbed except for areas within roadway and parking area construction limits

NOTE: See Figure C-1-12 for additional areas.

FIGURE C-1-11 DESIGN GUIDE FOR SAFETY REST AREAS

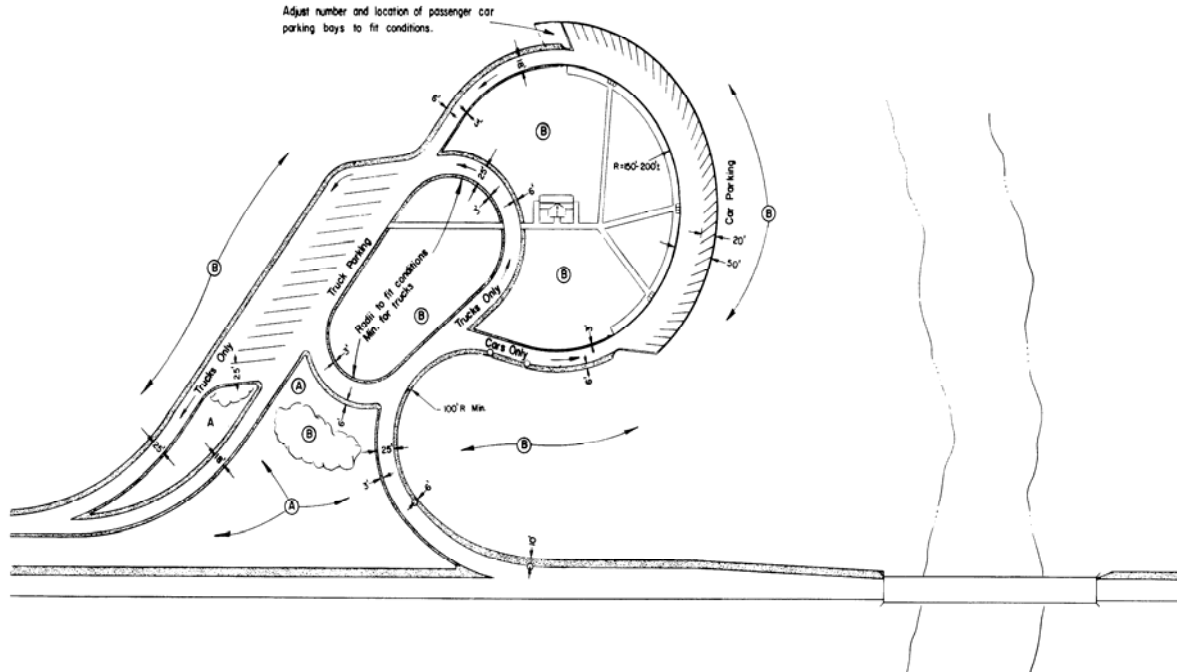

A. Denotes areas to be cleared, grubbed, graded, topsoiled, and seeded.

B. Denotes areas NOT to be cleared and grubbed except for areas within roadway and parking area construction limits

NOTES

Design types are to receive the approval of the Environmental Division.

Individual radii; length of ramps; individual ramp configuration, etc. are to be designed to fit the individual site conditions.

Design and dimensions shown hereon are approximate only.

Well and septic drainage field locations are to be recommended by the District Landscape representative. Testing and approval of soil conditions are to be obtained by the Environmental Division through the appropriate County and State agencies. Additional right of way for drain field should be acquired if necessary.

The proposed right of way limits should be discussed with the Environmental Division after preparation of the plan and grade lines in order that adequate area for required facilities will be obtained.

A single line of fence in median is to be specified if opposite rest areas are accessible, or if medians can be readily crossed by pedestrians. This fence should extend between points a minimum of 200 feet (60 meters) beyond ramp noses. Fencing in outer separator may be required because of site requirements.

Perimeter of rest area to be fenced unless otherwise recommended by the field party.

A note similar to the following is to be shown on the rest area detail sheet of all grading and drainage plans:

"No trees or shrub outside the limits of the rest area roadway construction are to be cut without the approval of the Landscape Engineer."

FIGURE C-1-12 DESIGN GUIDE FOR SAFETY REST AREAS

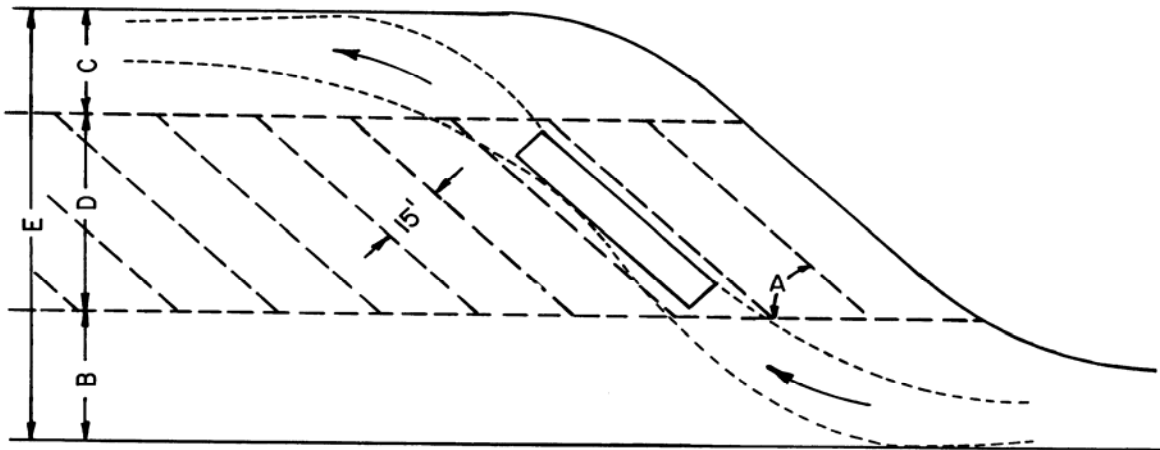

LEGEND

- A - ANGLE OF PARKING
- B - ENTRANCE ROADWAY WIDTH
- C - EXIT ROADWAY WIDTH
- D - PARKING WIDTH
- E - TOTAL WIDTH

DIMENSIONS FOR PARKING SPACES

ANGLE OF PARKING (DEGREES)	ENTRANCE ROADWAY WIDTH (FEET)	EXIT ROADWAY WIDTH (FEET)	PARKING WIDTH (FEET)		TOTAL WIDTH PARKING AREA (FEET)		NUMBER OF TRUCKS PARKED (PER ACRE)	
			D	E	55 ft. (WB-50) DESIGN VEHICLE	82 ft. LENGTH DESIGN VEHICLE	55 ft. (WB-50) DESIGN VEHICLE	82 ft. LENGTH DESIGN VEHICLE
30	20	20	40	54	80	94	17	11
45	30	25	50	69	105	124	19	16
60	40	30	55	79	125	149	19	16

FIGURE C-1-13 DESIGN FOR ANGLE PARKING OF TRUCKS

For additional information, see the most recent AASHTO's Guide for the Design of Park-and-ride Facilities.*

* Rev. 1/07

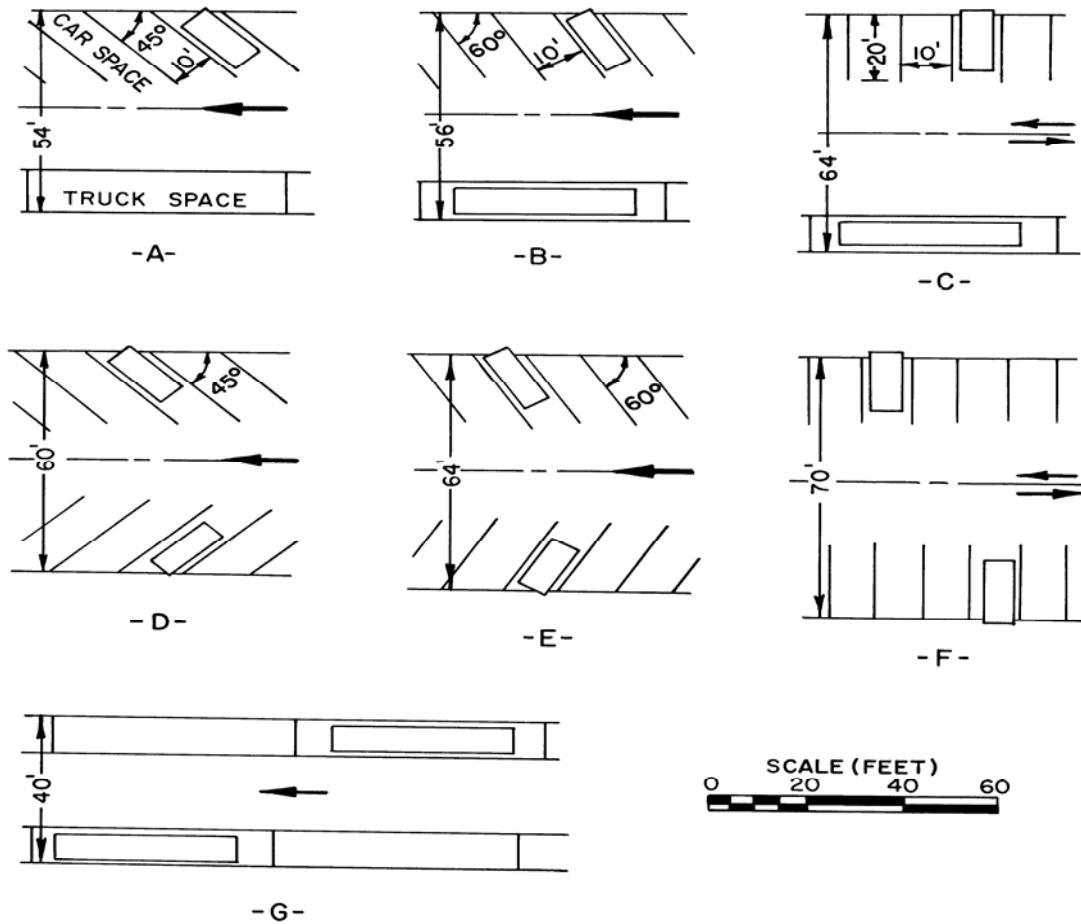

SUMMARY OF PARKING SPACE ARRANGEMENTS

Central Roadway	Type of Vehicle and Angle of Parking		Total Width Parking Area (feet)	Number Vehicles per 120 linear. feet	
	Left	Right		Left	Right
A One-way	Trucks-parallel	Cars-45°	54	2	8
B One-way	Trucks-parallel	Cars-60°	56	2	9
C Two-way	Trucks-parallel	Cars-90°	64	2	12
D One-way	Cars-45°	Cars-45°	60	8	8
E One-way	Cars-60°	Cars-60°	64	9	9
F Two-way	Cars-90°	Cars-90°	70	12	12
G One-way	Trucks-parallel	Trucks-parallel	40	2	2

For additional information, see the most recent AASHTO's Guide for the Design of Park-and-ride Facilities.*

FIGURE C-1-14 DESIGN FOR PARKING SPACES

* Rev. 1/07

SECTION C-2-ENVIRONMENTAL

NOISE ABATEMENT

In order that all factors are considered in reaching a decision on the installation of noise abatement, a joint committee comprised of members from the Federal Highway Administration and the Department will use the following flow chart in reaching decisions related to noise abatement features. During the development of the plans and the review of the noise abatement features by the Noise Committee, it will be the designer's responsibility to:

1. Provide cost for various walls as requested by the Committee.
2. Note on Right of Way plans that noise abatement is being considered affecting specific parcels and until final decision is reached, acquisition should be held in abeyance.
3. If the locations being considered for noise barriers are known prior to field inspection, they should be shown on the plans in the approximate location and be labeled possible noise barrier.

NOISE ABATEMENT DECISION FLOW PROCESS

PRELIMINARY PLAN REVIEW

The District environmental specialist participates in this preliminary plan review for the purpose of identifying noise sensitive activities in this early stage of project development where engineering solutions to potential noise problems may be possible.

DRAFT EIS

The Draft Environmental Impact Statement presents existing and future noise levels and identifies the potential need for noise abatement. Potential location and approximate geometry of noise abatement features are shown. Preliminary cost data for abatement features are submitted to the engineering divisions for incorporation into the total project cost.

LOCATION PUBLIC HEARINGS

The district environmental staff (with assistance from Environmental Division noise staff as necessary) would respond to noise related inquiries. Plans depicting the abatement features and a copy of the Draft EIS are made available for public review.

FINAL ENVIRONMENTAL IMPACT STATEMENT (EIS)

Generally the noise section of the Final Environmental Impact Statement consists of a reorganization of the existing data for the selected alternative. Additional noise sensitive land use development in the project corridor or revisions to the highway alignment may require an update of the noise analysis and abatement considerations. Abatement features determined to be not prudent are deleted from the project proposal.

FIELD INSPECTION AND FINAL DESIGN OF ABATEMENT FEATURES

The details of noise abatement features are reviewed on the site. Included in this review are such items as abatement material and design construction techniques and value engineering considerations. Abatement features and alternatives to noise mitigation such as vegetative screening and privacy fences are discussed. The participants in this field inspection should include representatives from FHWA, L & D, ED, the district and the city, if applicable. Following this field inspection, the final design of the abatement features is completed and cost data for specific abatement materials and designs are developed.

DESIGN PUBLIC HEARING

Plans and pertinent data for probable abatement features are made available for review at the public hearing as an element of the overall project proposal.

PUBLIC INTERACTION

Probable noise abatement features and non-noise mitigation measures are presented to involved citizens and their input is sought, unless such input has been otherwise obtained.

DECISION

Noise abatement related decisions are reached on the basis of acoustical, engineering and socio-economic data acquired to this point. The team decision should include a recommendation on whether the abatement features should be included with the project contract or be advertised as a separate contract.

APPROVAL OF THE NOISE STUDY

For projects which do not fall under Certification Acceptance, noise study, the abatement proposals and exception requests are submitted to FHWA for approval. For projects which fall under Certification Acceptance, the approval is rendered by the Director of Planning and Programming.

RIGHT OF WAY

The Right of Way and Utilities Engineer is advised of the need for noise abatement related right of way by the State Location and Design Engineer.

PLANS, SPECIFICATIONS AND ESTIMATES (PS & E)

If a significant time period has elapsed between the approval of the noise study and submission of the PS & E assembly, it may become necessary to update the abatement related data in the noise study, reevaluate abatement costs, and resubmit it to FHWA with the PS & E.

CONSTRUCTION REVIEW

The Department and FHWA review the abatement features with the contractor during construction.

SECTION C-3 RIGHT OF WAY

CRITERIA FOR PLACEMENT OF RIGHT OF WAY MONUMENTS

Right of way monuments will be installed in accordance with the following criteria:

1. Interstate with Arterial, Primary, or Secondary Crossroad:
 - (a) On inside and outside of PC's and PT's
 - (b) Along minor road until existing right of way is tied in
 - (c) All right of way breaks
 - (d) At beginning and end of project unless monumented on previous project
 - (e) At 2500' (750 meter) intervals between right of way breaks
2. Arterial or Primary with a Secondary Crossroads:
 - (a) Same as 1(a)
 - (b) To end of right of way flare of major road
 - (c) Same as 1(c)
 - (d) Same as 1(d)
 - (e) Same as 1(e)
3. Secondary Roads
Show distance and plus to all right of way breaks with no monuments.

Where the right of way is variable around curves, use chords in lieu of arcs, limiting the number of chords to those actually needed to accurately delineate the right of way, but without obtaining excessive right of way. The foregoing is the general rule, but if it is necessary to use a curved non-concentric right of way line, then this line shall be described by arc length, radius and central angle. Where right of way around a curve is a constant distance from the baseline on which it is based, it is to be shown as a concentric curve.

When a right of way break is positioned in the vicinity of a property line, it is to be positioned so as not to be confused with the property line. The practice of showing the proposed right of way lines intersecting a property line at a break point is not acceptable unless it is necessary for some reason that the break be on the property line.

A necessary condition, for instance, would be for an entire taking where a part of the taking would be in fee right of way with the remaining residue being described along the proposed acquisition line. Another condition would be where the proposed right of way begins or ends on the existing right of way (see Figure C-3-1).

Survey parties have been, for some time, locating all existing property corners (monuments, stones, iron pins, trees, fence corners, etc.) referenced to the survey baseline by station and right angle offset or radial offset distance with both station and distance being accurately measured to the nearest one-hundredth of a foot. Property line bearings are furnished, calculated from the bearing of the survey and the direction of the bearing referred to this base line. Therefore, all pluses and distances can be calculated and shown to the nearest one-hundredth of a foot.

The practice of scaled pluses and distances for these right of way break points will not be acceptable.

The monuments along right of way lines, to meet inter-visibility requirements, shall be estimated by studying the grades or left up to the party setting the monuments to be placed at least every 2500' (750 meters). It is preferable to make an estimate from the plans to reduce the possible overrun on right of way monuments in the summaries.

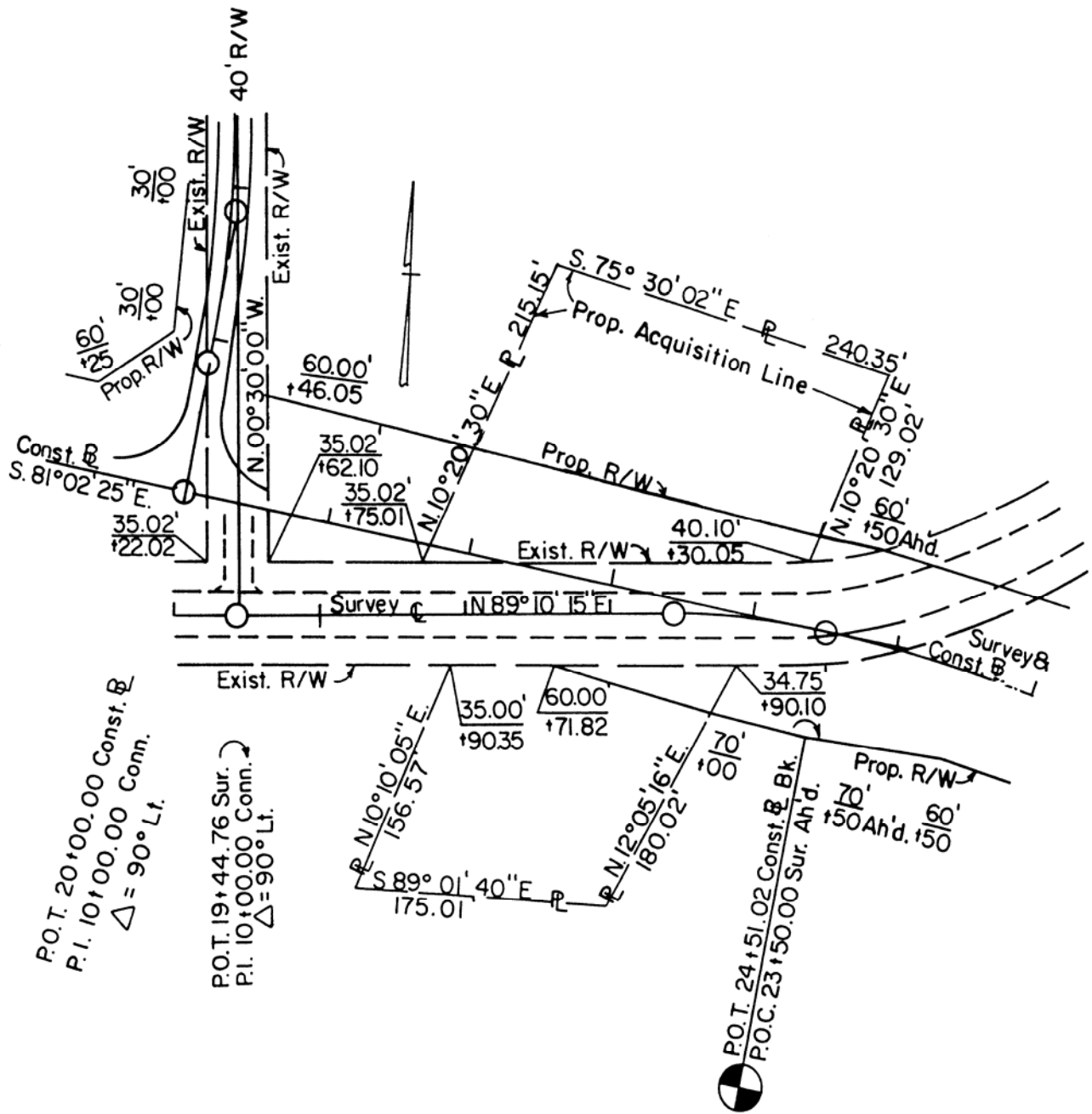

FIGURE C-3-1 SKETCH SHOWING SURVEY PROPERTY LINE TIE AND PROPOSED R/W BREAK POINT

SECTION C-4-WATER RELATED PERMITS

REVIEW OF PUBLIC NOTICES

The Department frequently receives copies of public notices from the Corps of Engineers and/or U.S. Coast Guard advising us of permit applications for various items crossing navigable waters such as overhead power lines, bridges, and underwater telephone cables. The Corps of Engineers and the U.S. Coast Guard have requested that all contacts in response to these public notices be from a single state agency. The Governor designated the Dept. of Environmental Quality as the contact agency. Any comments or objections are to be submitted to their office in writing. The Location and Design Engineer will review these public notices and act as the clearinghouse for all comments and/or objections from the Department. The Assistant Location and Design Engineer in charge of Location will consolidate and submit all comments to the Dept. of Environmental Quality. If there are no comments, then no response is necessary.

INTRODUCTION (PERMIT APPLICATION)

The following material is intended to provide Location and Design personnel with an overview of the process by which the Department obtains permits from other agencies for its construction in or near waterways. It also provides detailed instructions for the compilation of that part of a permit assembly that is the responsibility of Location and Design personnel.

The information and procedures outlined herein are based on current practices and the Department's experience to date. Revisions and modifications will be issued in the future as necessary to reflect changes in the permit process.

TYPES OF PERMITS	ISSUING AGENCIES
River and Harbor Act of 1899	U.S. Army Corps of Engineers U.S. Coast Guard
Public Law 92-500, Section 404	U.S. Army Corps of Engineers
Public Law 92-500, Section 401 Virginia Water Protection Permit(VWPP)	Department of Environmental Quality
Public Law 92-500, Section 402	Environmental Protection Agency
Subaqueous Bed Permit	Virginia Marine Resources Commission
Tennessee Valley Authority Permit	Tennessee Valley Authority
VDOT General Permit	U.S. Army Corps of Engineers Virginia Marine Resources Commission
Navigable Water Permit	U.S. Coast Guard

PERMIT APPLICATIONS

PERMIT APPLICATION PROCEDURE

The determination as to the need for permits is the responsibility of the District Environmental Managers. The normal procedure is for the District Environmental Manager to handle all permit matters for all projects in that District, regardless if plans are developed in the District or in the Central Office. The steps in the permit process are shown on the flow chart following this Section and are outlined as follows:

- Step 1 After a project has been initiated, the project designer will determine if a permit determination has been done on the project. If not, the project designer will request a permit determination from the appropriate District Environmental Section. Stated more precisely, the District Design Engineer or the Central Office project designer will make his/her request to the District Environmental Manager. The request is accompanied by a topo map and preliminary plans, if available, indicating the limits of the project and Form [LD-252](#) requesting supporting data.

Step 2 Upon receipt of this request, the District Environmental Section shall survey the project and determine what permits **MAY** be required. They shall notify the project designer initiating the request as to their determination.

Step 3 Upon receipt of the permit determination, the project designer is to notify all other disciplines who will be involved in the design of the project and, if a permit is required, requests that they furnish their respective components of the permit assembly at the earliest appropriate time. The District Design Engineer shall furnish the Central Office Coordinator a copy of the determination.

Typically, the project designer prepares the location map and basic sketches. If a bridge is involved, the bridge designer prepares the bridge sketch and obtain the hydraulic commentary from the Central Office Hydraulic Section. For facilities other than bridges, the project designer obtains the Hydraulic Commentary from the unit that designed the drainage items. The project designer obtains the construction commentary from the Scheduling and Construction Division in the case of a central office project or the Assistant District Engineer in charge of construction, if a district project, and if necessary, obtains the necessary property data from the respective Right of Way unit.

It is important to note that the initial permit determination is based on cursory data and is usually conservative, reflecting the most disruption that may be anticipated as a result of the proposed construction. If it becomes apparent during the development of a more detailed design that the proposed project will have little or no effect on the aquatic environment, the project designer shall request a review of the permit determination. To facilitate this, he shall submit a rough sketch showing the extent of the proposed activity (For details see Figure C-4-1).

Step 4 If a project requires a permit, as noted on the permit determination and after the project designer has received the required sketches and other information from the various disciplines involved, he will compile the permit assembly. The project designer will forward the entire assembly to the District Environmental Section making the permit determination. This step should occur after the public hearing requirements have been met and approximately one year prior to the project advertisement date.

The District Environmental Section will file the necessary permit applications on behalf of the Department.

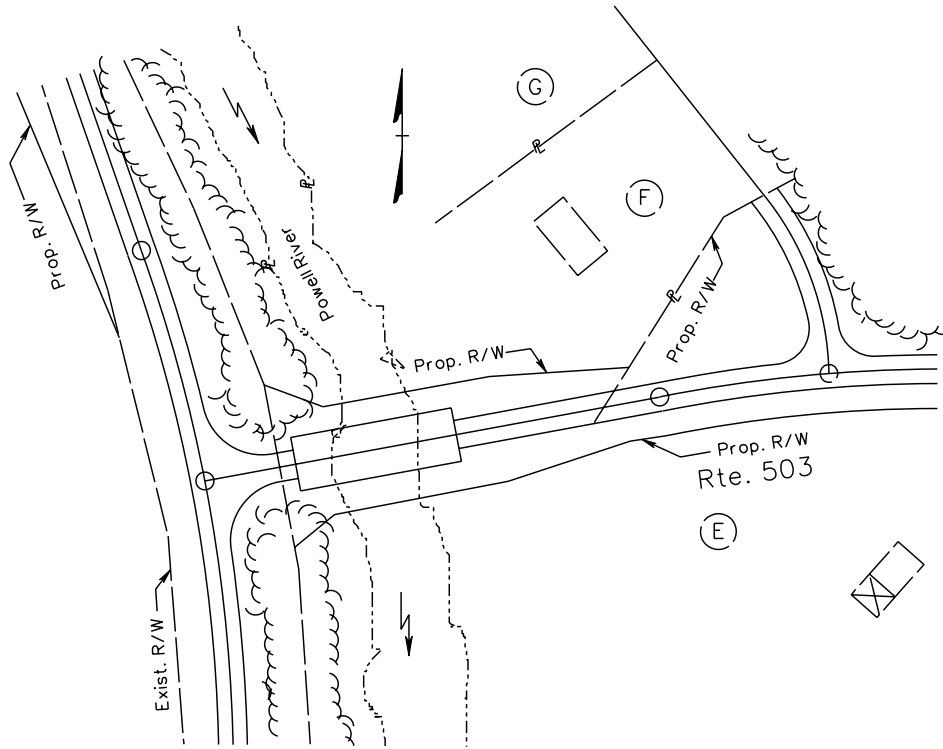

RTE. 530
SCOTT CO.

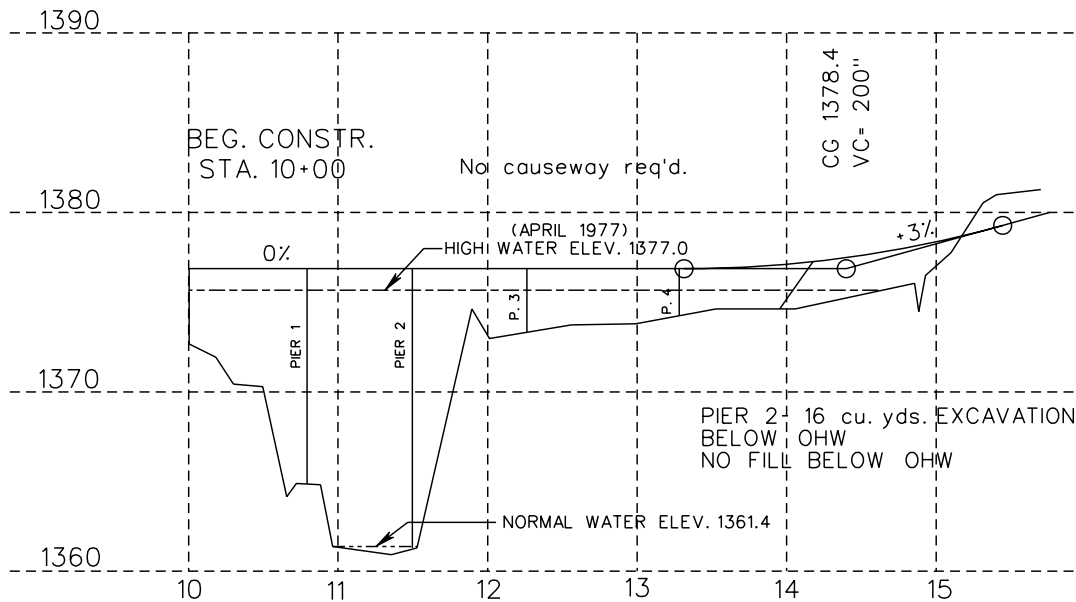
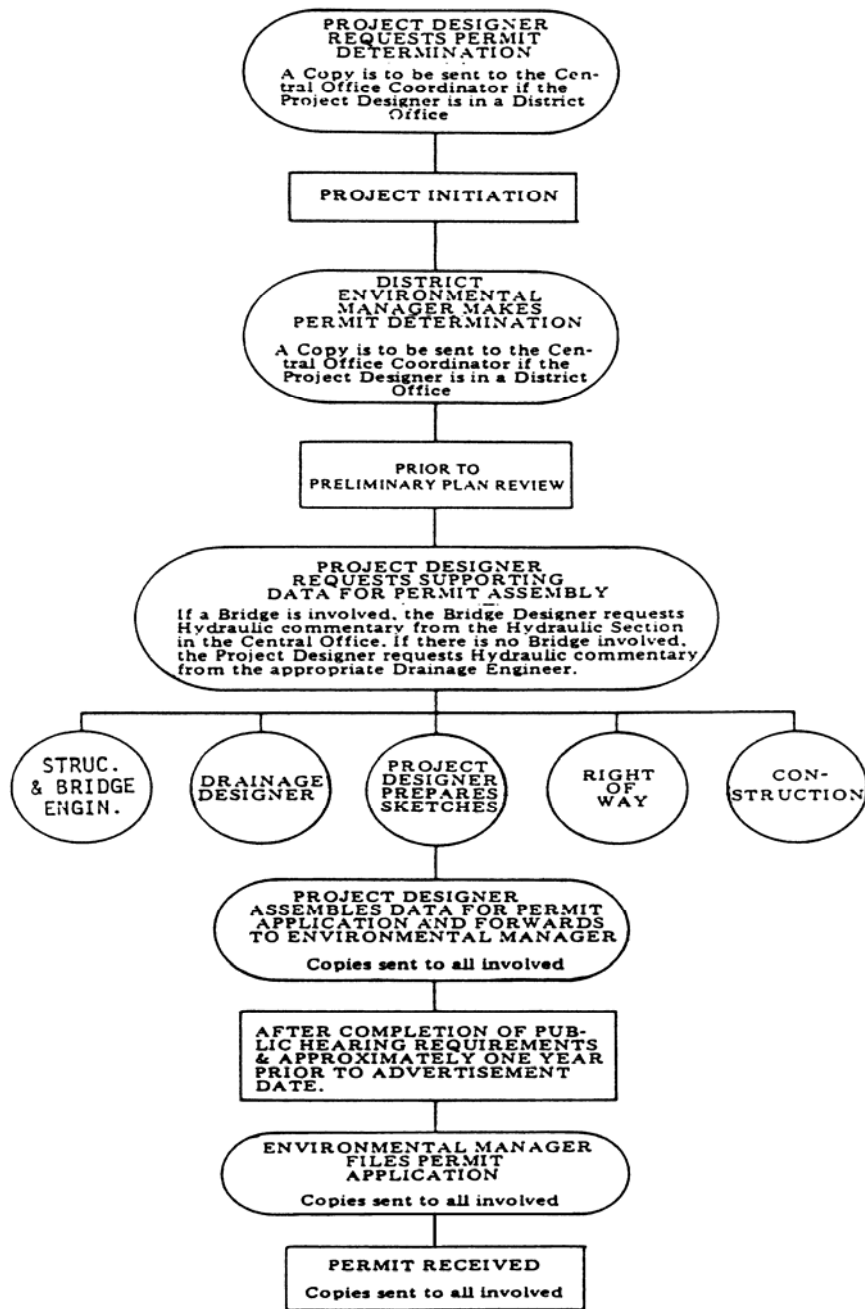

FIGURE C-4-1 PLAN AND PROFILE - PERMIT (ROUGH SKETCH)

VIRGINIA DEPARTMENT OF TRANSPORTATION
 PERMIT APPLICATION
 FLOW CHART



NOTE: THE PROJECT DESIGNER IN A DISTRICT OFFICE AND THE PROJECT DESIGNER IN THE CENTRAL OFFICE BOTH CORRESPOND WITH THE DISTRICT ENVIRONMENTAL MANAGER.

FIGURE C-4-2 PERMIT APPLICATION FLOW CHART

DRAWING REQUIREMENTS

The permit sketch is to be drawn on paper sheets measuring 8 ½ x 11 inches (216 mm x 279 mm) with a 1" (25 mm) border at the top and half-inch (12 mm) borders on the remaining three sides. The plan and profile views are to be drawn to the largest scale practical to clearly show the details of construction which the various permits address. In most cases, more than one sketch sheet will be needed to adequately show all of the details for each of the different views. For example, in a tidal area, the edge of existing stream mean low tide, mean high tide, limits of mud wave, limits of wetlands, and limits of oyster planting grounds may all have to be shown in addition to other pertinent information. When such is the case, a larger than normal scale must be used which would in turn lead to more than one sketch sheet. A maximum effort is to be directed toward clarity and the elimination of unnecessary details not pertaining to the subject of the permit (i.e., it is not necessary to show details of bridge parapets, guardrail, etc., but it is necessary to show cofferdam locations and channel cleanouts.

The applicable water elevations and corresponding quantities are outlined in the next three paragraphs. Note that the demarcation of ordinary high water and tide lines refers to their location prior to the proposed construction. For fresh water streams, the ordinary high water and wetlands limits (if applicable) need to be shown. Quantities will be figured channelward and below ordinary high water.

For fresh water lakes, the ordinary high water, ordinary low water and limits of wetlands (if applicable) need to be shown. Quantities will be figured channelward and below ordinary high water.

For tidal areas, the mean low tide, mean high tide and limits of wetlands (if applicable) need to be shown. Quantities are to be figured from where the tide lines touch the original banks (1) Channelward of and below mean low tide line and (2) Channelward of mean high tide line and below to the horizontal and vertical planes of mean low tide.

In addition, the total area to be filled below the applicable high water line is to be stated. The area of wetlands to be filled is to be stated separately. These areas are those within the limits of construction.

In addition to showing the wetland mitigation site(s) on the plan view, include, as appropriate, both a contour map with the proposed and adjacent contours and a typical cross-sectional view with the proposed grade of the site(s) in relation to the approximate adjacent ground/wetlands elevation. A primary concern of the VMRC involves slightly sloping mitigation sites to minimize trenching and excessive ponding. In addition, an enlarged plan view depicting species to be planted at the appropriate elevations if helpful.

In summary, it is suggested that a copy of the drawing checklist be utilized and made a part of the file when the sketches are prepared, since this will be the procedure followed when the sketches are reviewed before being submitted to the District Environmental Manager. When questions arise pertaining to the preparation of the permit sketch, the Hydraulics Section in the Central Office is to be consulted.

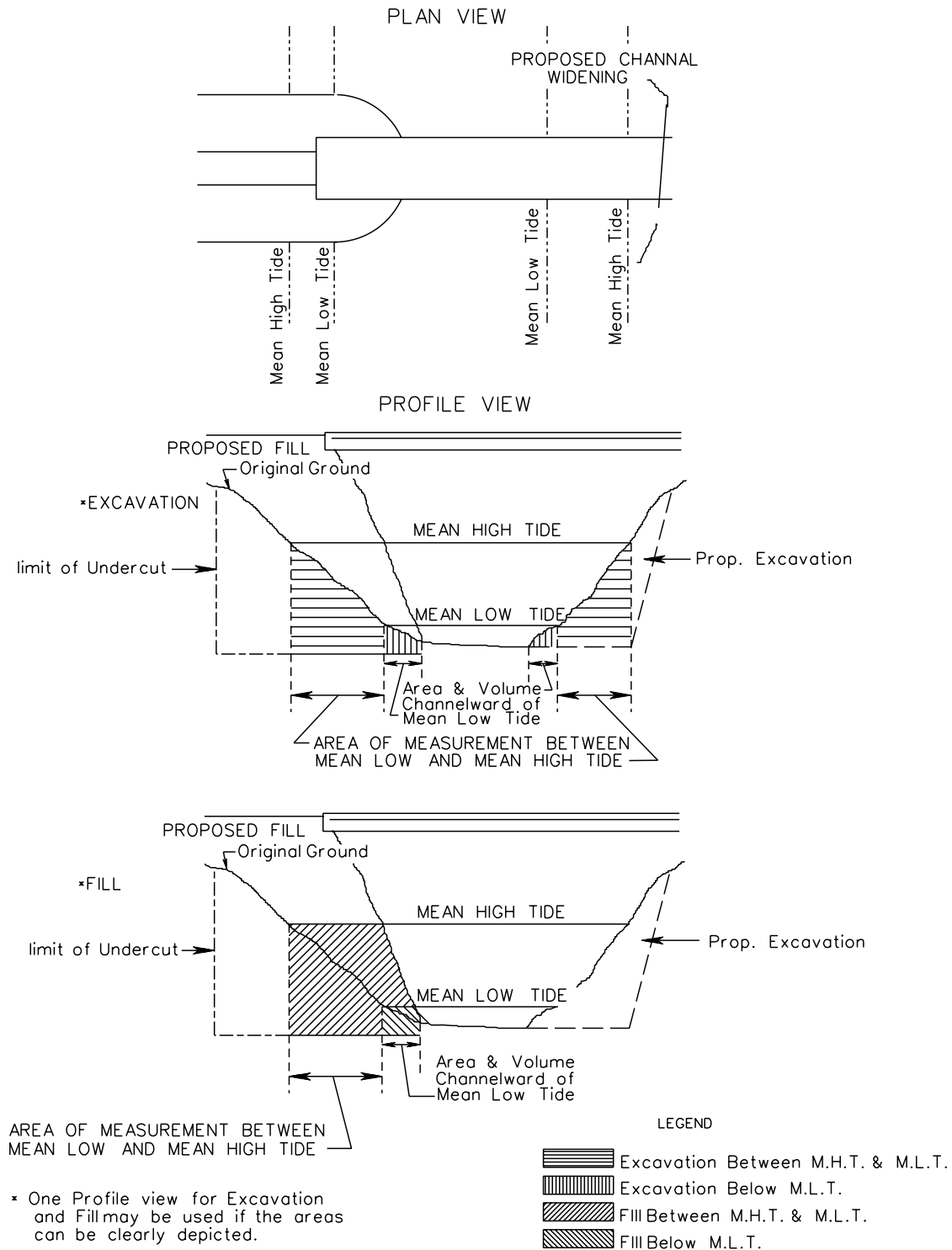

FIGURE C-4-3 MEASUREMENT OF EXCAVATION AND FILL AREAS BETWEEN MEAN LOW AND MEAN HIGH TIDES

DRAWING CHECKLIST (TO BE STRICTLY ADHERED TO)

1. General

- () Submit one copy original of all drawings on paper sheets measuring 8 ½ x 11 inches (216 mm x 279 mm). Submit the fewest number of sheets necessary to adequately and clearly show the proposed activity. Drawings should be in accordance with the general format of the enclosed sample drawings and must be of good reproducible quality. Block style lettering should be used. Do not use freehand sketches.

It is recommended that the drawings be in ink on plastic sheets. Prints may be made from these sheets and may, in turn, be used as the "copy original" for the permit application. The original drawing will be retained by the designer to facilitate revisions.

- () A 1" (25 mm) margin is to be left at the top edge of each sheet for binding purposes and a half inch (12 mm) margin on the other three sides.
- () Drawings are not to reflect the approval, non-objection, or action of other agencies.
- () Since drawings must be reproduced photographically, color shading cannot be used. Drawings may show proposed work using stippling, hatching, cross-hatching, or similar graphic symbols.
- () Each drawing submitted should identify the project and contain the route and project number; the name of any applicable body of water and/or stream; river mile, if applicable; name of county; number of sheet and total number of sheets in a set; and date the drawing was prepared.
- () State datum used as basis for elevations (mean sea level, mean low water or National Ocean Survey datum in tidal areas / ordinary high water in non-tidal areas).
- () Subsequent revised drawings, as required, must be dated.

2. Vicinity Map

- () Show location of each activity site (to scale) including latitude and longitude on a portion of an original USGS Topo map. Show name of the USGS map(s) used.

- () *Show name of waterway and river mile (if applicable).
- () *Show name of and distance to local town, community or other major landmark(s). Show city and/or county boundaries where applicable.
- () Show graphic scale.
- () Show North arrow (preferably oriented so North is pointing to top of sheet).
- () *Show route numbers and names of roads in the vicinity of the activity site.

*Note: A cut out from a county map with the scale, north arrow and activity site identified may be used in lieu of showing distances and route numbers/road names on the topographic map.

3. Plan View (To be drawn to as large a scale as practical)

- () Show name of waterway.
- () Show distance between proposed activity and water channel or navigation channel where applicable.
- () Show location and boundary of any wetlands. (Use COE's (Corps of Engineer's) multiparameter method for boundary delineation.)
- () Show existing shorelines if different from ordinary high water or mean high tide.
- () Show ebb and flood in tidal waters and direction of flow in non-tidal areas.
- () Show North arrow (preferably oriented so North is pointing to top of sheet).
- () Show graphic scale or "not to scale." (Adequate dimensions must be provided on "not to scale" views. Freehand sketches are unacceptable).
- () Show existing and/or proposed VDOT right of way and easements, existing easements owned by others and existing and/or proposed utilities where applicable.
- () Show proposed and/or existing roadway limits and existing structure to be replaced.

- () Show proposed construction limits including channel changes and easements.
- () Show relocated utilities if they are part of the project and located within our right of way easement.
- () Show applicable erosion control devices. (Do not place in "live" streams.) Show stream bank stabilization.
- () Show mean high and mean low tides if proposed activity is in tidal areas.
- () Show delineation of ordinary high water line if activity is in a non-tidal area.
- () Show normal pool elevation (level) if activity is on a lake.
- () Show principal dimensions of structure or work and extent of encroachment channelward of the mean high water and mean low water lines (for tidal areas only), or ordinary high water line (for non-tidal areas only), or normal pool elevation (level) for lakes.
- () Show the location for dredging, excavation, or fills below the applicable high water line, type of materials, and methods of handling. If applicable, indicate the number of cubic yards to be dredged, excavated and/or filled below and channelward of the ordinary high water line. In a tidal situation indicate the applicable dredged and/or fill quantities (1) below and channelward of the mean low water line, and (2) between the mean low water and mean high water lines.
- () Indicate, if applicable, the total area in square feet to be dredged and/or filled below the ordinary high water line or in a tidal situation, the mean high water line.
- () If known, show location of fill or spoil disposal area. If spoil material is to be placed in an approved spoil site, a separate map showing the location of the spoil site must be attached. The drawings must indicate proposed retention levees, weirs, and/or other devices for retaining hydraulically placed materials. If any de-watering or spoil material re-enters State waters, the site will need a permit.
- () Show and identify structures, if any, in navigable waters immediately adjacent to the proposed activity including permit numbers, if known.

- () Show water depths on either side of the project at mean low water (for tidal areas only) or ordinary high water (for non-tidal areas only) when a temporary causeway, dredge channel or channelization is part of the proposed project.
 - () If applicable, indicate the total area in square feet of wetlands to be filled and/or dredged based on the COE's (Corps of Engineers') multiparameter method for boundary delineation.
 - () Depict the wetland mitigation site(s).
 - () Show property lines and identify adjacent property owners and addresses. On narrow waterways the property owner on the opposite shore must also be identified. (Not required for general permit sketch.)
 - () Show limits of wetlands for fresh water and tidal areas, if applicable. Also show spot elevations adjacent to project when the foregoing criteria applies.
 - () Identify the limits of oyster planting grounds, if applicable.
 - () Show the limits of anticipated mud wave, if applicable.
 - () Show proposed causeways, cofferdams and detours, if applicable.
 - () Show composition of causeways and cofferdams.
4. Profile View* (To be drawn to as large a scale as practical to depict the proposed structure, cofferdams, piers, stream bank stabilization, etc., in relation to the stream.)
- () Depict the proposed structure(s) perpendicular to the center line if not skewed. If skewed, depict the structure looking upstream along the angle (or line) of skew or perpendicular to the centerline if a simple profile view (looking upstream) is given.
 - () If extensive channel dredging or channel relocation is proposed, show the proposed dredging grade or channel profile as appropriate.
 - () Show same water elevation as for plan views, including wetlands elevation, if applicable.

- () Show proposed and/or existing structures (with invert elevations in the case of culverts).
- () Show proposed and/or existing road grade elevations over proposed structures.
- () Show graphic scale or "not to scale". (Adequate dimensions must be provided on "not to scale" views.)
- () Show elevation of spoil areas, if applicable.
- () Show by cross hatching, area of fill below applicable high water.

*Note:

Small depictions of the profile view of temporary causeways/haul roads/detours with pipes, work bridges may be shown on the plan view if space permits and if such features are attendant/secondary. When projects are modified to include or reflect changes to these features, the features should be adequately depicted on a larger scale.

5. Cross-sectional View** (Adequate dimensions must be provided to describe activity - Does not have to be to scale).
- () Show typical view of longitudinal roadway encroachments into streams and wetlands. The wetlands shown must be those based on the COE's (Corps of Engineer's) multiparameter method for boundary delineation.
 - () Show the typical view of channel relocations with low-flow provisions as appropriate.
 - () Show disposal sites with elevation of berms and any overflow pipes if any dewatering or spoil material will re-enter State waters.
 - () Show same water elevations as for plan view, including wetlands elevation, when applicable.
 - () Show cross section of excavation or fill and side slopes.
 - () Show elevation of spoil areas, if applicable.

- () Show depth of waterward face of proposed work or if dredging is proposed, show dredging grade.
- () If a fill, float, or pile supported platform is proposed, show dimensions above applicable high water line and identify any structures to be erected thereon.
- () Show by cross hatching, area of fill below applicable high water.

**** Note:**

- (1) Small depictions of typical cross-sections of temporary causeways /haul roads /detours, work bridges and detour bridges may be shown on the plan view if space permits when such features are attendant/secondary. When permits are revised to reflect changes to or include such features, larger depictions are preferable.
- (2) Cross-sections are to be used to depict different type features and/or options of structural features. The detail/size of such cross-section is discretionary.
- (3) Cross-sections referenced to the plan view are helpful.

6. Wetlands Mitigation Sketches

- () In addition to showing the wetland mitigation site(s) on the plan view, include as appropriate, a contour map with the proposed and adjacent contours and a typical cross-sectional view with the proposed grade of the site(s) in relation to the approximate adjacent ground/wetlands elevation. In addition, an enlarged plan view depicting species to be planted at the appropriate elevations is required.

7. Notes on Drawings

- () List names and addresses of adjacent property owners whose property also adjoins the water, if not shown in plan view. (Not required for general permit sketch).
- () State purpose (private use, commercial, public, etc.) of proposed activity. (Identify Project).
- () If petroleum products or other hazardous material will be stored or handled at the proposed facility, so indicate.

- () State datum used in plan, profile, and section views. (Mean Low Water, National Ocean Survey Datum or USGS).
- () List names and addresses, separate from the property owners, of known claimants of Water Rights and/of oyster planting Grounds, if applicable.
- () State the method of dredging, if applicable.
- () State the number of m³ (cubic yards) to be dredged, excavated or filled channelward of and below the ordinary high water line (causeways and fill type cofferdams inclusive).

or

State the number of cubic yards (m³) to be dredged, excavated or filled (1) Channelward of and below Mean Low Tide and (2) between Mean Low Tide and Mean High Tide (causeways and fill type cofferdams inclusive). See Figures C-4-6 and C-4-7.

- () State the total area in square feet (m²) to be filled and excavated channelward of and below applicable high water line. State separately the entire area of wetlands in sq. ft. (m²) filled (causeways and fill type cofferdams included.)

HYDRAULIC COMMENTARY FOR PERMIT APPLICATIONS

1. State source (or base) of hydrologic computations - i.e., "regional analysis of USGS gage data" or "empirical formulas such as Circular IV and USGS multiple regression formulas. State design frequency of projects, Q design, Q100.
2. State historical data - i.e., "high water marks for the 1969 flood obtained by VDOT field reconnaissance or from local resident." State discharge and frequency, if possible.
3. State type of hydraulic calculations - i.e., "FHWA Circular 5 -Culvert nomographs, FHWA Bridge Backwater Program, USACE HEC-2 W.S.P. Program, etc."
4. Display or describe by appropriate means the effect of the 100-year flood level under existing conditions and under proposed conditions.

It is recognized that the scope of this data will vary widely between different project types. Bridges and major streams will require adherence to the "1 on 100-year" rule or a detailed justification for deviating from the rule. Culverts and smaller streams are less restricted, although a statement of justification for our action is still required.

DISTRIBUTION OF COPIES OF PERMIT APPLICATIONS

Permit Application Data	to the Environmental Unit
District Environmental Section	2 complete assemblies, 1 containing original sketches
Scheduling & Contract Division Engineer	cover letter only
Programming Division Director	cover letter only
Bridge Designer.....	2 copies of bridge sketches and bridge construction commentary, if applicable
Assistant L&D Engineer - Rd. Des.....	1 complete assembly
Drainage Designer	1 complete assembly
File	1 complete assembly

GENERAL CONSTRUCTION NOTES AND EROSION AND SILTATION CONTROL NARRATIVE

The attached list of notes has been prepared for use as a guide in making permit application. It appears that one or more of the following conditions may exist on projects and the appropriate notes are to be used for the applicable condition:

-
- Condition No. 1 - Proposed Channel Change Outside the limits of existing live streams - Use note numbers 1 and 2.
 - Condition No. 2 - Proposed Channel Change inside the limits of existing live stream - Use note number 1.
 - Condition No. 3 - Proposed Culvert (Pipe or Box) outside the limits of existing stream - Use note numbers 1 and 4.
 - Condition No. 4 - Proposed Culvert (Pipe or Box) inside the limits of existing stream where topography will permit temporary channel change - Use note numbers 1 and 3.
 - Condition No. 5 - Proposed Culvert (Pipe or Box) inside the limits of existing stream where topography will not permit temporary channel change - Use note numbers 1 and 5.
-

Note No. 1 - Construction of proposed and temporary channel changes and culverts will be performed in such a manner as to minimize siltation of streams. Coordinate the essential sequence of operations so that work in live streams (including tie-ins on existing streams to proposed or temporary channel changes and culverts) will be scheduled for the season occurring during the life of the contract at which stream flow is at or near its minimum.

Prior to beginning excavation in live streams (including tie-ins) for proposed and temporary channel changes and culverts, required erosion control devices downstream from the proposed location(s) will be in place. Such devices will be properly maintained during construction at the respective locations. Material excavated for construction of proposed and temporary channel changes and culverts will be deposited within the roadway prism or in designated waste areas in such a manner as to prevent its return to streams by high water or run off. Backfill and approach fills for culverts will consist of excavation material. Erosion control devices will be strategically located as shown on the plan view to prevent siltation of streams during placement of backfill and approach fills and until the slopes are stabilized in accordance with Virginia Department of Transportation's Road and Bridge Specifications.

Note No. 2 - Proposed Channel Change(s) No. _____ will be constructed in the dry, with the exception of tie-ins to existing live streams, and will be completed (including stabilization of the bottom and slopes) prior to diverting existing streams through proposed channel change(s). Once excavation for the tie-ins is begun, it shall be continuously prosecuted to completion, including stabilization of bottom and slopes.

Note No. 3 - Culvert(s) No. _____ will be constructed by diverting the stream through a temporary channel change during excavation for and installation of the culvert(s). The temporary channel change will be constructed in the dry, with the exception of tie-ins to existing stream, and will be completed (including necessary stabilization of bottom and slopes) prior to diverting stream through temporary channel change. Once excavation for the tie-ins for the temporary channel change is begun, it shall be continuously prosecuted to completion including necessary stabilization of the bottom and slopes. The stream will not be diverted through the proposed culvert(s) until installation is complete, including required stabilization of inlet and/or outlet channel(s).

- Note No. 4 - Culvert(s) No. _____ will be installed in the dry, with the exception of tie-ins to existing live stream. The minimum temporary channel change necessary to maintain the integrity of the channel will be constructed to provide the dry condition during installation of the culvert(s). Once excavation for the tie-ins is begun, it will be continuously prosecuted to completion, including any required stabilization of inlet and/or outlet channel(s).
- Note No. 5 - Culvert(s) No. _____ will be constructed by diverting the stream through a temporary pipe culvert or temporary diversion channel during excavation for and installation of the proposed culvert(s).
- Note No. 6 - Measures shall be employed to prevent and/or control spills of fuels and/or lubricants from entering state waters. In the event that oil or other hazardous spill material has potential to or gets into state waters, the Contractor shall immediately notify the State Water Control Board and will take immediate actions for the containment and removal of such spill.
- Note No. 7 - The Department will enforce the application of the following temporary and permanent erosion and siltation control measures for the work to be done on both shores of _____.
- a. Temporary filter barriers will be placed at the base of fill at the abutments and around the perimeter at the base of the causeway.
 - b. Temporary filter barriers will be installed in accordance with Section 303 of the Virginia Department of Transportation's Road and Bridge Specifications. The Contractor will regularly inspect the temporary barriers and correct any deficiencies in accordance with Section 107 of the Virginia Department of Transportation's Road and Bridge Specifications.
 - c. Cut and fill slopes will be promptly seeded in accordance with the Virginia Department of Transportation's Road and Bridge Specifications.

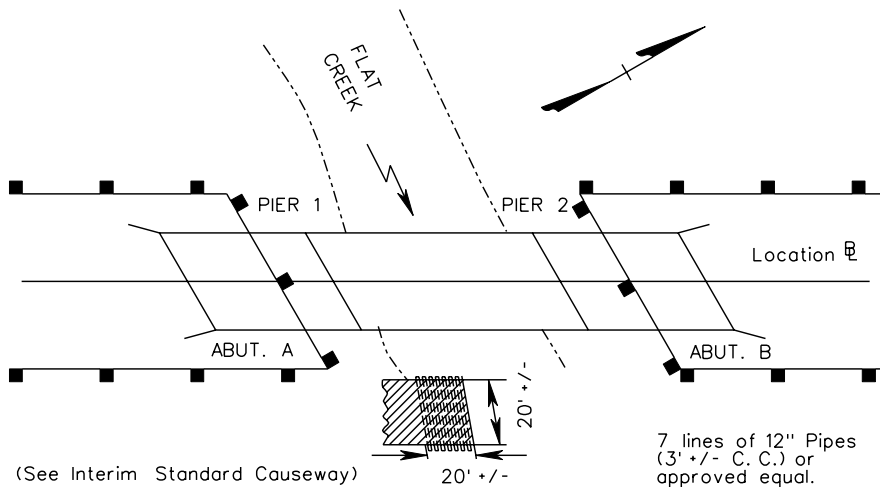

PLAN

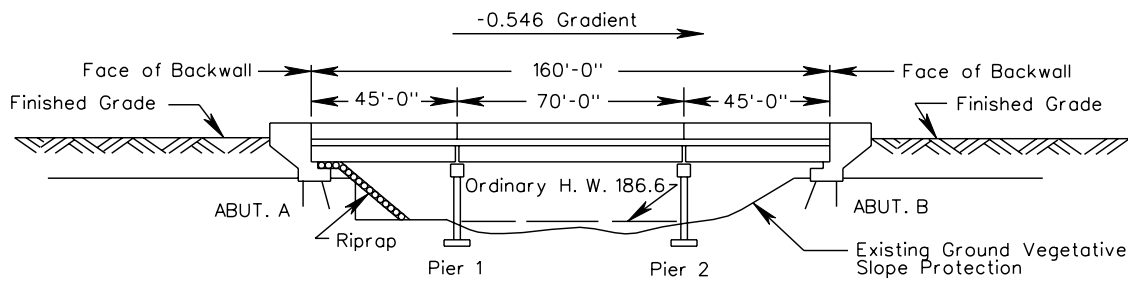
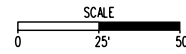

ELEVATION

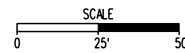

FILL BELOW ORDINARY HIGH WATER		
	Cu. Yds.	Sq. Ft.
RIPRAP	23	280
CAUSEWAYS	30	400
* CAUSEWAY IS OPTIONAL		
EXCAVATION BELOW ORDINARY HIGH WATER		
	Cu. Yds.	Sq. Ft.
RIPRAP	23	280
* CAUSEWAYS	30	400
EXISTING STRUCTURE	37	1000

PROPOSED BRIDGE ON RTE. 604
OVER FLAT CREEK
0.4 MI. N. INT. RTE. 632
COUNTY OF AMELIA
STATE OF VIRGINIA
APPLICATION BY: VA. DEPT. OF TRANS.

SHEET OF

FIGURE C-4-4 PROPOSED BRIDGE PLAN-PROFILE SKETCH

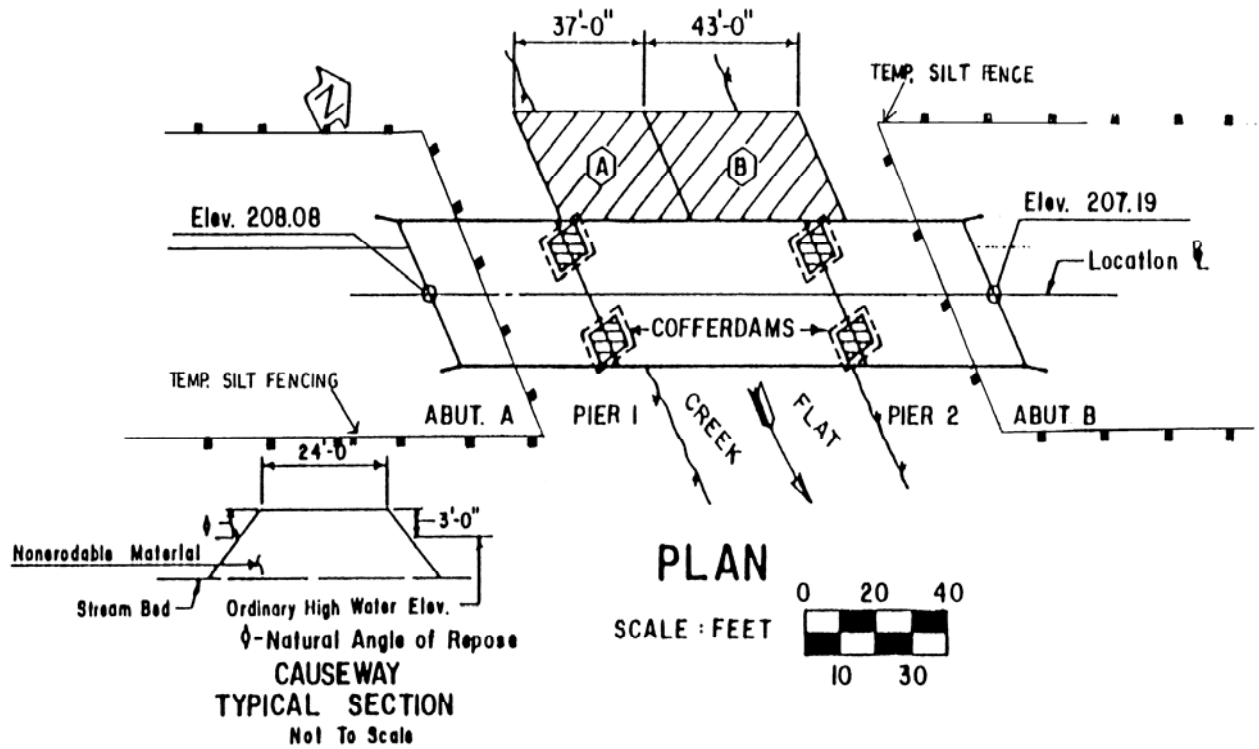

STRUCTURE EXCAVATION

- PIER 1 - 80 C.Y.
- PIER 2 - 73 C.Y.

CAUSEWAY QUANTITIES

	FILL	AREA
(A)	99 C.Y.	1200 S.F.
(B)	68 C.Y.	1400 S.F.

▨ DENOTES AREA OF EXCAVATION

▧ DENOTES CAUSEWAY

PROPOSED BRIDGE ON RTE. 604
OVER FLAT CREEK
0.4 MI. N. INT. RTE. 632
COUNTY OF AMELIA
STATE OF VIRGINIA
APPLICATION BY: VA. DEPT. OF
TRANS.

SHEET OF

FIGURE C-4-5 PROPOSED BRIDGE EXCAVATION AND CAUSEWAY SKETCH

PROJECT 0604-004-140,B-615**ROUTE 604 OVER FLAT CREEK**

1. Causeway A is to be constructed of non-erodable material as shown on the attached drawing. Causeway to be used for construction of Pier I and superstructure.
2. Excavation for Pier I to be performed within cofferdam placed from Causeway A. Cofferdam to be constructed so as to permit no siltation of the stream as a result of the excavation and backfill operations. Materials excavated from within cofferdam to be hauled from the site and used within the roadway prism.
3. After completion of Pier I and superstructure, the cofferdam and Causeway A are to be completely removed in such a manner as to cause minimal disturbance of the stream and hauled from the site to be used within the roadway prism or salvaged.
4. After removal of Causeway A, Causeway B is to be constructed of non-erodable material as shown on attached drawing. Causeway B to be used for construction of Pier.
5. Excavation for Pier 2 is to be performed within cofferdam placed from Causeway B. Cofferdam to be constructed as to permit no siltation of the stream as a result of the excavation and backfill operations. Material excavated from within cofferdam is to be hauled from the site and used within the roadway prism.
6. After completion of Pier 2 and superstructure, the material in cofferdam and Causeway B is to be completely removed in such a manner as to cause minimal disturbance of the stream and hauled from the site to be used within the roadway prism or salvaged.
7. All material disposed of within the roadway prism will be prevented from re-entry into the stream and its flood plains in accordance with Virginia Department of Transportation's Roadway and Bridge Specifications. Special Provisions and Supplemental Specifications.
8. The order of construction may be reversed in order to build Causeway B first thence following the above outlined procedures.
9. The existing bridge will be removed in accordance with our Road and Bridge Specifications.
10. The fill at the existing abutments will be removed and graded to the elevation of natural ground.

11. All fill material removed from the existing abutments shall be disposed of and prevented from re-entry into the stream and its flood plains in accordance with Virginia Department of Transportation's Roadway and Bridge Specifications, Special Provisions and Supplemental Specifications.
12. Measures shall be employed to prevent and/or control spills of fuels and/or lubricants from entering state waters. In the event that oil or other hazardous spill material has potential to or gets into state waters, the Contractor shall immediately notify the State Water Control Board and will take immediate actions for the containment and removal of such spill.
13. The Department will enforce the application of the following temporary and permanent erosion and siltation control measures for the work to be done on both shores of Four Mile Creek:
 - a. Temporary filter barriers will be placed at the base of fill at the abutments and around the perimeter at base of the causeway.
 - b. Temporary filter barriers will be installed in accordance with Section 303.02(e) of the "Virginia Department of Transportation Road and Bridge Specifications." The Contractor will regularly inspect the temporary barriers and correct any deficiencies in accordance with Section 107.14(a) of the "Virginia Department of Transportation Road and Bridge Specifications."
 - c. Cut and fill slopes will be promptly seeded in accordance with the "Virginia Department of Transportation Road and Bridge Specifications."

Purpose: Construction of New Highway For Public Use
 Datum: USGS
 Date:
 Proj.: 0252-081-100, C-501
 Propose: 82'-60" Pipe Culvert on Moffatts Creek in Rockbridge County, State of Virginia.
 Appl. By Virginia Department of Transportation.

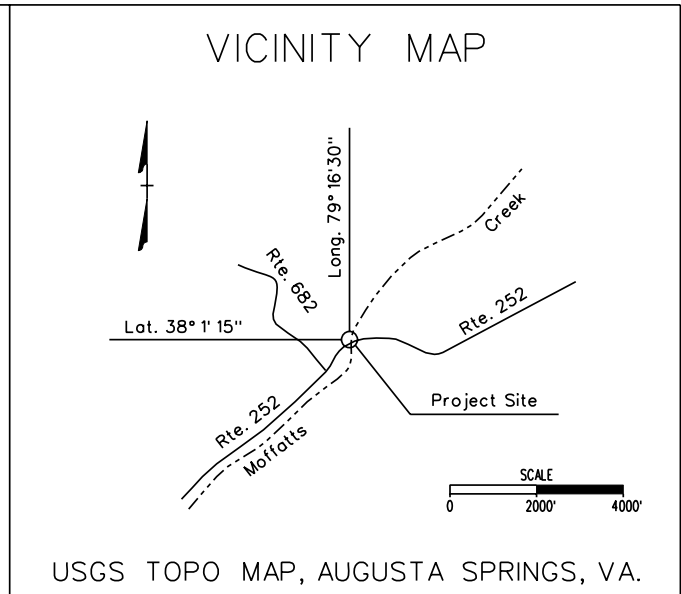

PROPERTY OWNERS

- ① J. A. Applegood
Rte. 2, Box 3
Newport, Va.
- ② R. L. Smith
Rte. 2, Box 4
Newport, Va.
- ③ B. F. Locke
Rte. 2, Box 1
Newport, Va.

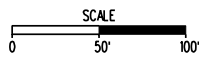
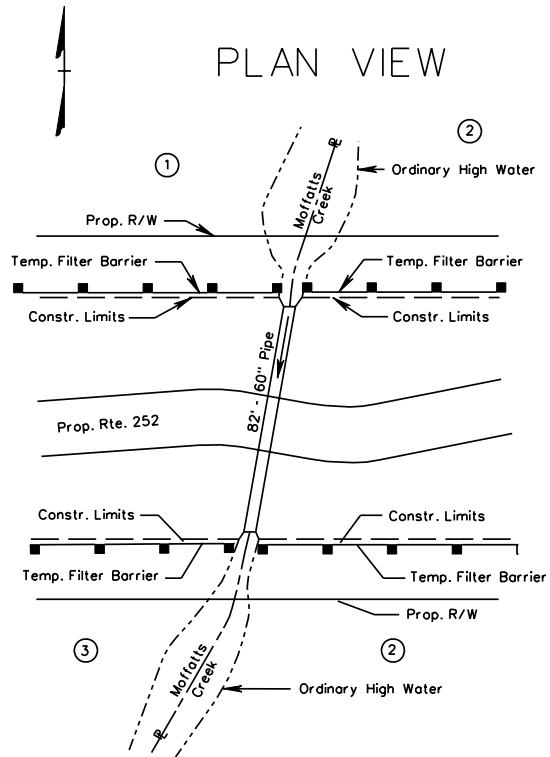

FIGURE C-4-6 CULVERT (NON-TIDAL) PLAN VIEW

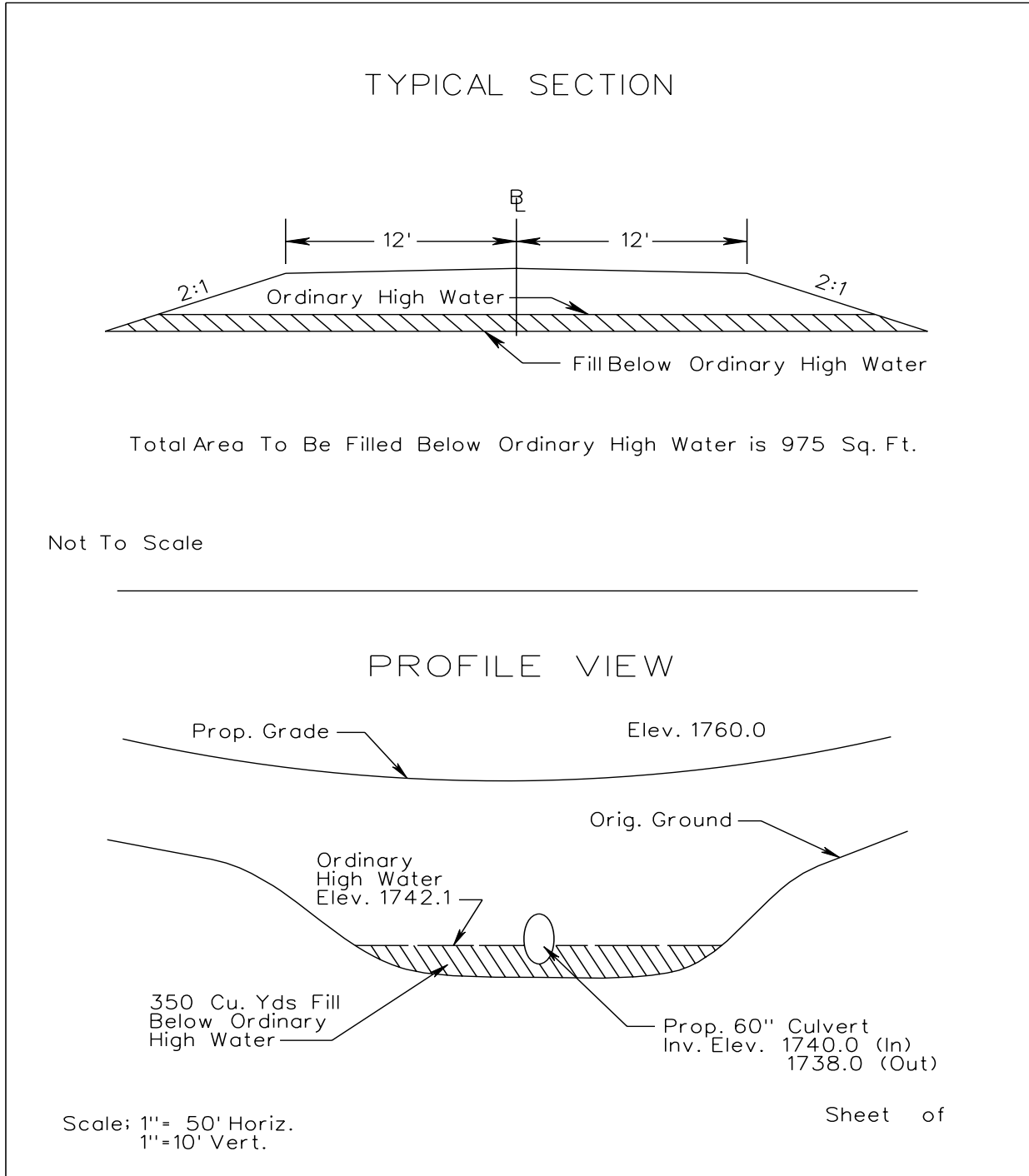

FIGURE C-4-7 CULVERT (NON-TIDAL) -TYPICAL SECTION AND PROFILE VIEW

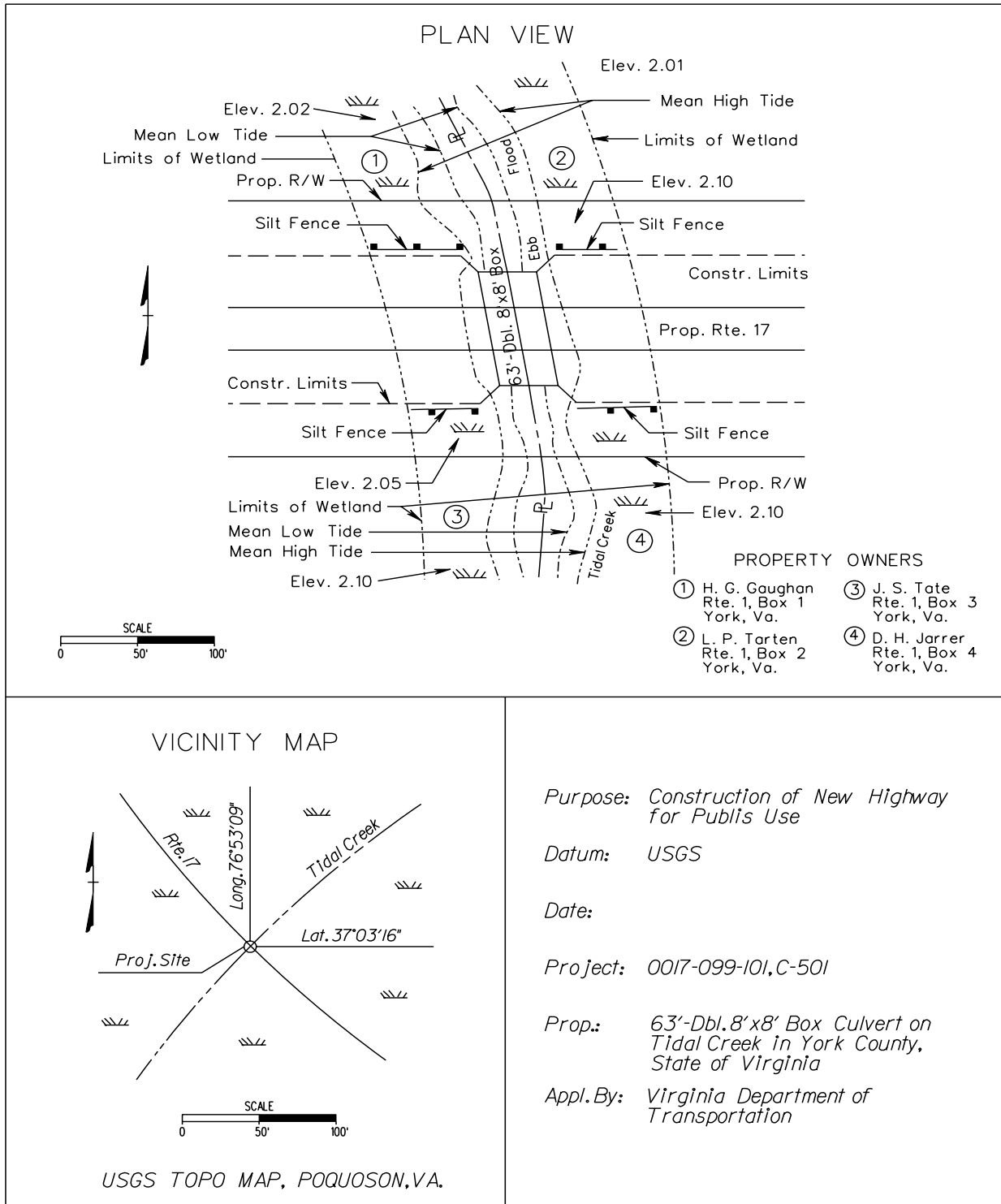

FIGURE C-4-8 CULVERT (TIDAL)-PLAN VIEW

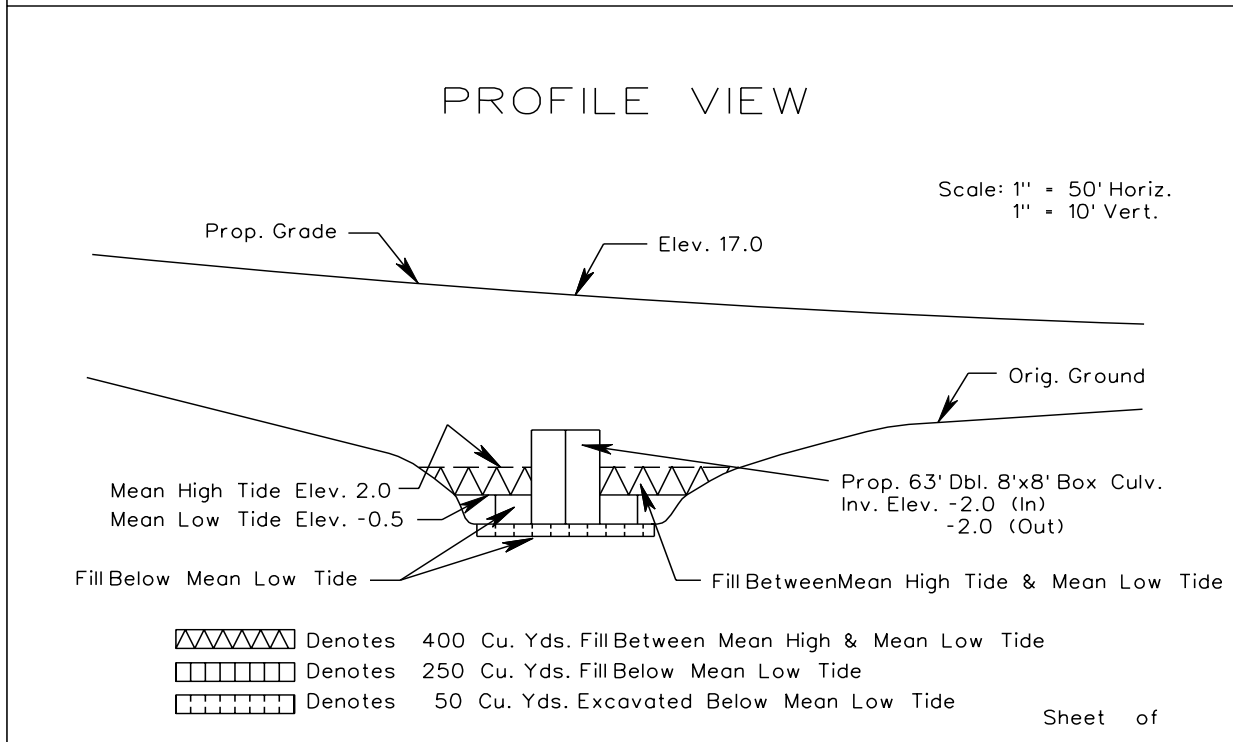
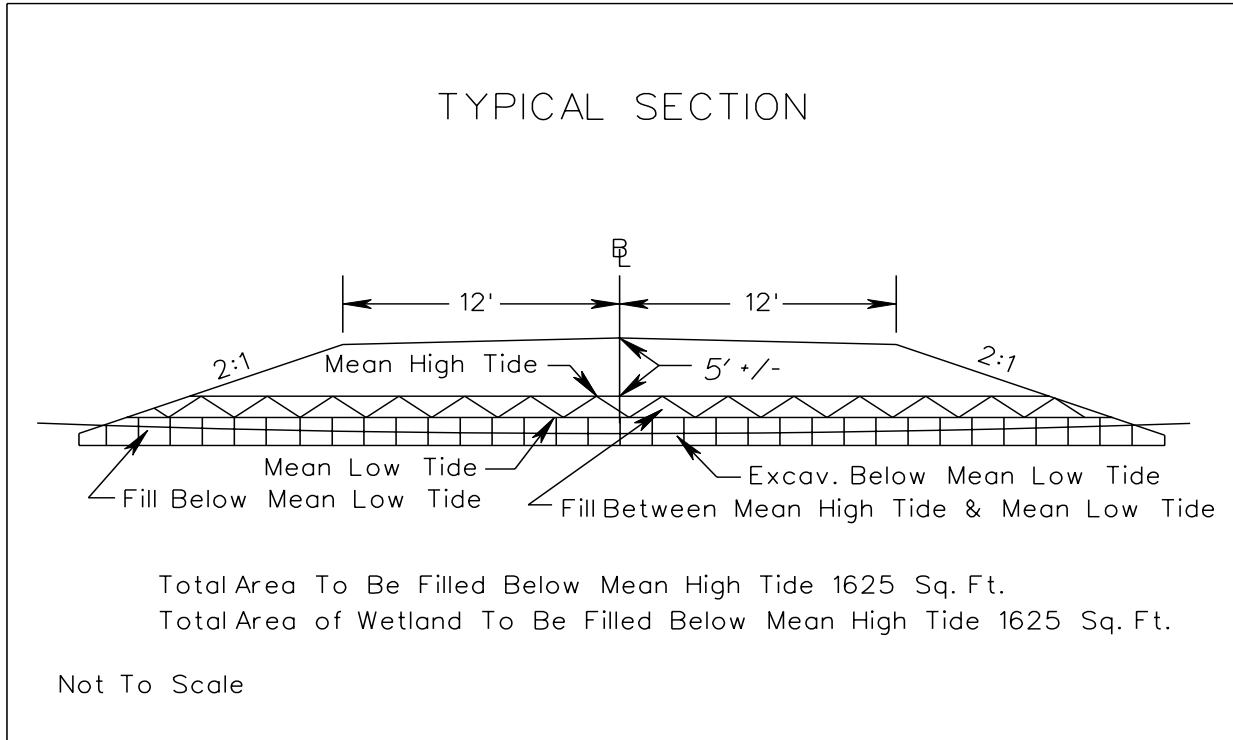

FIGURE C-4-9 CULVERT (TIDAL) -PLAN VIEW

SECTION C-5 SAFETY PROJECTS

PROCEDURES

The preliminary steps utilized to implement Federal-Aid Primary Safety Projects requiring surveys and plans need to realistically correlate planning with funding commitments. Many projects are delayed either due to a nonsystematic approach or to the total project cost being estimated low in the early stages, and are delayed in the final stages when more current estimates have been obtained. Much of this disparity is caused by changes in the scope of projects from that originally envisioned. The objective of the following procedures is to promote a joint and cooperative effort of all units involved in the planning process to arrive at a more realistic project concept and financial understanding which should result in a realistic scheduling process.

1. The selection process for the project will proceed as in the past, with the Traffic Engineering Division in cooperation with the District Administrator and appropriate division(s) in selecting projects for inclusion into the safety program. Information pertaining to the scope and nature of the proposed projects is to be provided to the MMD for their use in the justification process and obtaining priority approval from the FHWA.
2. After priority approval of the project, the State Traffic Engineer is to request the Project Manager to request a UPC number in IPM*. After the project number is assigned, the Traffic Engineering Division will notify the appropriate divisions and each division will be requested at this time to commence the necessary work to implement the project.
3. The State Location and Design Engineer, upon receipt of the approval of the project, will request preliminary engineering authorization. As soon as authorization has been received, the State Location and Design Engineer will instruct the District Location and Design Engineer to proceed with preliminary plans.
4. The District Design Transportation Engineering Program Supervisor will consult with the District Traffic Engineer, District Construction Engineer and Residency Administrator so that the proposed improvement may be outlined utilizing aerial photography, topographic maps, or other material suitable for a preliminary field study if deemed necessary. The actual survey is to be held in abeyance until after the preliminary scheme has been approved.

* Rev. 1/07

The State Location and Design Engineer will be available to assist in supplying any mapping or photography which may be required to complete the above.

5. Upon defining the scope and intent of the project, the District Design Transportation Engineering Program Supervisor will request historical and archeological survey and permit determination using Form [LD-252](#). A brief description of the work should be noted in the remarks.
6. The District Design Transportation Engineering Program Supervisor, upon completion of Step 4, will notify the [Traffic Engineering Division](#), The Location And Design Division, and the [District Construction Engineer](#)* that the project is now ready for a preliminary plan review and make arrangement, if necessary, for scheduling the review. Due to the limited Preliminary Engineering Funds, only those representatives from the Environmental, Right-of Way, Traffic Engineering, Materials, or any interested Division the District Administrator deems necessary may be requested to attend.

Items pertaining to the need for a field inspection, anticipation of donated right of way, or type of public hearing, etc., should be fully resolved at the plan review. The scheduling should be discussed and dates set for the different stages in the development of the project. After the dates have been fixed, all affected divisions should be advised.

7. The result of the plan review along with construction estimates, right of way, and utility estimates as required, should be forwarded to the State Location and Design Engineer with copies to MMD.

The State Traffic Engineer will complete his review and, should be concur with the proposed scheme of development, advise the State Location and Design Engineer in order that the necessary field survey can be initiated.

8. Upon completion of the survey, the District Design Transportation Engineering Program Supervisor will plot the necessary plans and show the scheme of development along with the grades, proposed right of way line, and obtain a realistic construction cost. At this point a scoping review will be made to ascertain if the project is still within the scope and nature of intended work and within the funding limitations.

* Rev. 7/06

A set of prints with scoping Form [LD-403](#) should be provided the District Administrator. If he/she approves, the prints with Form [LD-403](#) should be forwarded to the Programming Division for scoping and then to the State Location and Design Engineer. A set of prints and an estimate should also be forwarded to MMD.

Approval to proceed will be documented by the receipt of scoping Form [LD-403](#) indicating final scoping is complete. The State Location and Design Engineer will advise of the scope approval by scoping Form [LD-404](#) and request the District Location and Design Engineer to proceed with the development of the project. From this point the project development will proceed in accordance with the normal design procedures including public hearing, Utility Field Inspection, and right of way requirements.

At this time, the District Design Transportation Engineering Program Supervisor should request the District Environmental Section, by Form [LD-252](#), to prepare the appropriate environmental document. Copies of Form [LD-252](#), should note a brief description of the work in the remarks with copies of the form forwarded to Environmental Engineer and the State Location and Design Engineer.

9. Any major deviation from the agreements reached at the preliminary plan review as indicated in Item No. 5 must be evaluated as to the difference in cost and this information transmitted along with the prints and Form [LD-403](#), as indicated in Item 7, so that any change from the original concept can be included in the decision making process. It is imperative to ascertain that the revised project still satisfies the original objective within a reasonable funding scope. This will reduce the disparity in cost previously mentioned in the opening remarks of this section.

The above instructions apply to all Federal Safety projects, except secondaries, which are handled by the Local Assistance Division, other than justification which will be handled by the Traffic Engineering Division. Railroad Crossing projects are handled in a manner similar to these guidelines with the main exception being the fact that the plans, sketches, estimates, and work are done by the railroad company involved. In view of the mandatory allocation of manpower time and funding resources to priority projects, every step must be taken that will reduce or eliminate efforts expended throughout all Divisions within the Department. The project is to be viable from a funding and functional standpoint and every consideration shall be given to fulfilling all highway needs; however, the major thrust of manpower availability must be given to those projects for which funding is most readily available.

SECTION C-6- SITE PLAN REVIEW

I. CHECKLISTS FOR SITE PLAN COMPLETENESS

A. HOW TO USE THE CHECKLISTS

A Preliminary Site Plan/Rezoning Application Checklist and a Site Plan Checklist are provided.

The site plan should be checked for completeness by the appropriate county staff, then by the VDOT residency staff (except in Northern Virginia where the district staff should check it). To be most effective, complete site plans based on the checklist should be mandated by a county site plan ordinance. The checker should review the site plan to determine if every applicable item on the checklist is contained in the plan.

After the check for completeness, the checker will determine whether or not all the information necessary for a site plan review is available in the plan. If complete, the site plan is ready for review. If incomplete, the site plan should be returned for resubmittal.

B. CHECKLIST FOR PRELIMINARY SITE PLAN/REZONING APPLICATION COMPLETENESS

Check each item that is included in the site plan.

I. PROJECT IDENTIFICATION

- a. _____ Date.
- b. _____ Project name.
- c. _____ Name/address of applicant and land owner.
- d. _____ Magisterial district, county, state.
- e. _____ Map and parcel number.
- f. _____ Type of use.
- g. _____ Total hectares (acreage).
- h. _____ Current zoning.
- i. _____ Name of engineer/surveyor.

II. GENERAL SITE INFORMATION

- b. _____ Site plan (1 : 500 or larger).
- c. _____ North point on maps.
- d. _____ One reproducible plus _____ copies of plan.
- e. _____ Adjacent property identification
 _____ Name of owner _____ Current zoning
 _____ Location _____ Current use
- f. _____ Location and total hectares (acreage) of land uses.
- g. _____ Topographic map (2 m (5-ft.) interval or less).
- h. _____ Boundary survey with source and title.
- i. _____ Locations, names, and dimensions of proposed streets, entrances to existing highways, alleyways, building lines, easements, rights-of-way, interior travel ways, parking lots, and pedestrian system.
- j. _____ Flood plain limits, if applicable.
- k. _____ Locations, names, and dimensions of existing roads _____, easements _____, utility lines _____, rights-of-way _____, streams _____, and drainage ways _____.
- l. _____ Preliminary sketch plans indicating provision for all utilities including but not limited to
 _____ Drainage (including stormwater management)
 _____ Water supply _____ Sewage disposal
- m. _____ Typical street sections.

III. STATEMENTS

- n. _____ Proposed development conforms to the provisions of all applicable ordinances, regulations, and adopted standards (or note specific waivers sought).
- o. _____ Public improvements both on- and off-site that are proposed for dedication and/or construction and an estimate of timing of providing such improvement.
- p. _____ Proposed development schedule.

CHECKLIST FOR SITE COMPLETENESS

Circle the number or letter of items included.

I. GENERAL INFORMATION (IDENTIFICATION)

- A. Title of project and name of applicant.
- B. Names of engineer, architect, landscape architect, and/or surveyor and plan certification.
- C. Vicinity map with scale (no less than 1 : 25 000).
- D. Direction of north.
- E. Plan scale.
- F. Type and size of development.
- G. Right Of Way line, centerline, departing lot lines, lot numbers, subdivision limits, and limits of construction.

II. GEOMETRICS

A. GENERAL

1. Typical section designation. Where special typical section is approved, provide detail on plan.
2. The edge of proposed street surface or the face of curb (as the case may be) and the full length of all streets.
3. The width of right of way, width of surface, or distance between curb faces and relation to center line.
4. All temporary turnaround construction, with easement as indicated on the preliminary plat.
5. Centerline curve data, including delta, radius, arc, chord, tangent, and profile data.
6. Radius of all curb returns to face of curb and on streets where curb and gutter are not required; radius to edge of bituminous treatment.
7. Stations at every 100 feet (meters) at even stations on centerline; stations at points of curve and tangent at the beginning and end of all returns, at centerline intersection, and at subdivision or section limits, and turnaround radius.
8. State route number and or city or town street name on all existing streets to which connection is to be made. Indicate proposed street name where appropriate.
9. Any notes necessary to explain the intent and purpose of plans or profile.

B. ROADS

1. Existing entrances, entrances of planned developments that are committed, street connections, crossovers, etc. that are located along existing roadway that may be affected by the proposed development.
2. Where proposed streets or entrances connect with existing roads or streets, indicate both edges of existing pavement, surface, or curb and gutter for a minimum of 100 ft. (30 m) or the length of connection, whichever is the greater distance.
3. Symmetrical transition of pavement at intersection with existing street.
4. Lengths of acceleration lanes and left and right turn lanes and tapers.
5. Crossover spacing and sight distance.
6. Sight distance profiles at all proposed street intersections and entrances, and landscaping, sign placement, and all obstructions that may obstruct or affect sight distance. Dedication of easements for improving sight distance.
7. Functional classification and design speeds for proposed public roadway improvements.
8. Existing roadway geometrics and pavement markings.

C. OTHER

1. Guard rail where required.
2. Location of curb ramps where appropriate.
3. Dedication of easements for future improvements in the comprehensive plan, state projects, or road bond programs.
4. Sidewalks and trails.

III. DRAINAGE

A. Systems

1. Contour map showing complete coverage of the total contributing drainage area.
2. Locations and dimensions of all existing or proposed drainage easements.
3. Direction of drainage flow for all proposed streets, storm sewers, valley gutters, subdrains, and the like, and all existing streams.

4. All storm sewers and appurtenances. Identify storm sewer appurtenances by type and a number. Station on plan must conform to stations shown on profile. Indicate the top and invert elevation of each structure. Tabulation in the plan view may be permitted.
5. Complete drainage calculations for all proposed facilities and all affected existing facilities, as required in VDOT's Drainage Manual.
6. Profiles on outfall ditches, pipe, etc.; indicate natural drainage and label if applicable.
7. Protection for erosion control
8. A design for adequate storm water management with calculations and appropriate data where necessary.
9. Any notes necessary to explain the intent and purpose of the proposed drainage plan.

B. DRAINAGE STRUCTURES

1. The size of all driveway entrance culvert, i.e., 15" (380 mm) or 18" (450 mm), according to computed size, for each lot.
2. The contributing area in hectares (acres) at all culvert pipe, curb inlets, and other entrances, exclusive of driveway pipes.
3. Type or class of pipe to be installed both in right of way and outside right of way.

C. DITCHES

1. Proposed drainage ditches for full length in all easements. Furnish detailed typical section and type of stabilization to be provided.
2. Paved ditches and easements at toe of fills.
3. Paved roadside ditches.

D. STREAMS

1. The location of all streams or drainageways related to the street construction.
2. Proposed stream relocations. Show existing and proposed locations. Furnish detailed typical section and type of stabilization.

IV. UTILITIES

A. GENERAL

1. All proposed water mains, their sizes, valves, and fire hydrants.
2. All proposed sewer lines.

3. All existing utilities; if within limits of proposed right of way, provide details as to location and typical sections.
4. Where security lighting is proposed, indicate the following:
 - a. Distance of pole from edge of pavement.
 - b. Distance of pole from proposed right of way.
 - c. Distance from pole to center of luminaire.
 - d. Height of luminaire above centerline of roadway.
 - e. Level of illumination.
5. Any notes necessary to explain the intent and purpose of proposed utilities or adjustment of existing utilities.

V. TRAFFIC ANALYSIS

Developer will be responsible for supplying sufficient information for VDOT to determine entrance and road design features to serve the existing roadway and the proposed development adequately. The information may include:

1. Traffic analysis for site development on existing and proposed facility used to determine design of entrances, including trip generation and traffic assignment.
2. On-site circulation patterns for potential impact on existing roadway.
3. Intersection analysis including need for signalization, channelization, turn lanes, and modification of existing signals.
4. Existing and proposed traffic control devices such as signs and pavement markings.
5. Recommendations for roadway improvements to accommodate traffic generated by proposed development, including proposed signal phasing plans.
6. Any notes necessary to explain the intent and purpose of the proposed traffic analysis.

VI. COMMENTS

A. DESIGN

1. Site plans and subdivision plans shall be designed in accordance with the appropriate manuals of the Virginia Department of Transportation:
 - a. Minimum Standards of Entrances to State Highways, Mobility
 - b. Subdivision Street Requirements, Local Assistance Division.
 - c. Road and Bridge Standards, Location and Design Division.
 - d. Drainage Manual, Location and Design Division.
 - e. Land Use Permit Manual, Asset Management Division.
 - f. Guidelines for Lighting by Permit on State Right of Way, Asset Management Division.

These design standards are considered minimal. In keeping with its mission to provide a safe, efficient, and effective ground transportation system, VDOT is obligated to make recommendations that exceed these standards where it is deemed necessary and in VDOT's best interest.

2. Where a county has adopted standards higher than VDOT standards, the higher standards of the county should prevail.

B. RESUBMITTAL

A written description of all plan revisions must accompany all revised plans submitted for reevaluation and approval. The description should state each problem and its resolution. If the resolution does not concur with state and county recommendations, an explanation must be given. The changes should be clearly illustrated on the plans.

II. SITE PLAN REVIEW CHECKLIST

VDOT reviews site plans for a wide range of types and sizes of land development. There are specific elements that are a part of all reviews. However, each review should be tailored to meet the site-specific conditions for the area and the proposed project. To the extent practical, short-, medium-, and long-range implications should be considered. A substantial amount of engineering judgment may be used.

Circle the number or letter of items that are acceptable.

I. ACCURACY AND COMPATIBILITY

- A. Verify the location and dimensions of existing roadway elements of the plan.
- B. Examine the compatibility of the site plan with the six-year road improvement plan, the county master plan, and VDOT's statewide highway plan. Examine all available sources to eliminate discrepancies.

II. INTERNAL CIRCULATION PATTERN

- A. Review proposed internal circulation patterns to determine if their traffic flow patterns allow for vehicular circulation to take place on-site and not on the street system.

- B. Review driveway location(s) relative to intersections and other driveways and adjacent property lines.
 - 1. Check spacing from other drives for potential interference.
 - 2. Check spacing from signalized drives or intersections to determine if traffic queue will block proposed drive.
 - 3. Check access spacing to determine if the spacing from other signals will be conducive to a signal system if the proposed driveway(s) are signalized.
 - 4. Check projected queues for interference with traffic operations.

III INTERSECTION GEOMETRICS

(Proposed Entrances and Affected Intersections)

Verify that geometrics satisfy the appropriate design standards. Check the entrance of intersection designs, especially the radii and angle of intersection with the existing roadway.

IV. INTERSECTION SIGHT DISTANCES

- A. Check for intersection sight distances and compliance with the design requirements.
- B. Check for consideration of the numbers of buses and type and frequency of trucks entering and exiting the facility in determining sight distance needs.

V. AUXILIARY LANES

- A. Left-turn Lanes
 - 1. Check the need for and dimensions of a left-turn lane based on volume and traffic operations.
 - 2. Note that left-turn lanes are generally provided at median openings.
 - 3. Consider severe horizontal and/or vertical geometry, driver expectancy, accident experience, the effect of turning vehicles on through traffic, and observations.

- B. Right-turn Lanes
 - 1. Check the need for and dimensions of a right-turn lane.
 - 2. Consider severe horizontal and/or vertical geometry, driver expectancy, accident experience, the effect of turning vehicles on through traffic, and observations.
- C. Additional through lanes: Check the need for and dimensions of additional through lanes.

VI. PEDESTRIANS

- A. Estimate the volume of pedestrians and their needs.
- B. Review existing and proposed sidewalks and paths in the area and the need for sidewalks.

VII. SIGNALIZATION

- A. Verify that signalized intersections are studied as shown in the current Highway Capacity Manual.
- B. Determine if signals are required as warranted by the MUTCD.
- C. Review signal phasing and the need for certain phases such as protected and/or permissive phasing.
- D. Review adjacent signals and determine if signal coordination is needed.
- E. Consider preferred locations of signals for efficient signal systems.

VIII. SIGNING AND PAVEMENT MARKINGS

- A. Verify that signing and pavements markings are compatible with proposed traffic operations.
- B. Verify that signs and pavement markings located in both the driveway and internal areas are installed and maintained by the developer.

- C. Review existing and proposed signing and pavement marking.
- D. Verify that all signing is in accordance with the MUTCD and the Virginia Supplement to the MUTCD.

IX. FENCING

Check VDOT policy (when property abuts a limited access roadway). Consider fencing when an unusual need is present, e.g., railroad line.

X. ROADSIDE OBSTACLES

Review proposal to determine if traffic is being moved closer to fixed objects or roadside hazards and what, if anything, should be considered in accordance with VDOT's Road and Bridge Standards.

XI. ROADWAY LIGHTING

Review roadway lighting to be installed by the developer pursuant to Guidelines for Lighting by Permit on State Right of Way, Maintenance Division.

XII. RIGHT OF WAY

Determine if right of way denotation or easements are needed.

XIII. DRAINAGE

- A. Perform a spot check of drainage calculations for:
 - 1. Proper/applicable design methods and procedures.
 - 2. Completeness and accuracy.
 - 3. Change in flow patterns and diversions.
- B. Review drainage that would have a direct effect on the roadway.
 - 1. Check for adequate pavement drainage and proper placement of drainage structures.

2. Check the location and method by which pavement drainage is conveyed away from the travelway.
- C. Review drainage structures.
1. Check existing structures (storm sewers, ditches, etc.) for adequacy to convey the runoff that will come to them in conformance with applicable criteria/requirements.
 2. Check hydraulic design of proposed drainage facilities for conformance with applicable criteria/requirements.
 3. Check for proper treatment at ends of drainage facilities (riprap, paved ditches, etc.).
 4. Check detention facilities for required hydraulic performance, proper outfall, and adequate roadway protection.
- D. Review erosion control.
1. Check for current and potential erosion and siltation problems.
 2. Check for impact of the development.
 3. Check for the adequate placement of erosion control devices.
- E. Check involvements with regulatory flood plains and/or the 100-year flood zone.
- F. Check to ensure that all necessary drainage easements have been designated.

XIV. REVIEW COMMENTS

- A. Prepare written review comments. The comments should be well organized, clear, direct, and specific. Problems should be clearly defined and, when desired, actions to be taken to resolve each problem should be stated.
- B. Recommendations and requirements.
1. For compliance when minimum standards are involved, state that the design feature is required. Design features that exceed minimum standards but are required to resolve capacity or safety problems should be stated as required with an explanation.
 2. For design features that exceed the minimum standards state that the design is recommended or, if appropriate, highly recommended.

III. GUIDELINES FOR A TRAFFIC IMPACT STUDY

A. PURPOSE

A traffic impact study assesses the impact of a proposed development, zoning change, or special use approval on the transportation system. Its purposes are (1) to ensure that proposed developments or zoning changes do not adversely affect the transportation network, (2) to identify any traffic problems associated with access from the site to the existing transportation network, (3) to delineate solutions to potential problems, and (4) to present improvements to be incorporated into the proposed development.

The traffic impact study guidelines contained herein are subject to modification by VDOT and the county as necessary. They will be reviewed periodically and updated with state-of-the-art technical information. These guidelines have been developed in order to provide for consistent preparation of traffic impact studies. The guidelines will greatly enhance the efficiency of staff review and, at the same time, will provide the applicant with "accepted" technical procedures and methodologies. VDOT and the county will review each development application on a case-by-case basis and may make recommendations that differ from the guidelines.

B. RESPONSIBILITIES FOR TRAFFIC IMPACT STUDIES

The primary responsibility for assessing the traffic impacts associated with a proposed development rests with the applicant, with the county and VDOT serving in a review capacity. This is consistent with the approach followed for other civil engineering aspects of zoning and subdivision applications. The county and VDOT should specify whether a traffic impact study is required, the extent of the study area, and any specific issues that should be addressed (i.e., safety, accidents, truck traffic). This determination should be made in the rezoning application or preliminary site plan stage.

If a traffic impact study is required, the applicant will be responsible for submitting a formal traffic impact report. The applicant will also be responsible for all data collection efforts required in preparing a traffic impact study, including current peak period turning movement counts. Current peak period turning movement counts is defined as those counts that have been collected within one year of the zoning or subdivision application.

The county or VDOT, at its discretion, may request the applicant to adjust the peak hour turning movement counts in order to account for seasonal variations in traffic or other localized factors.

In addition, the applicant will be responsible for ensuring that any submitted site plans meet the minimum state and local standards for geometric design. The study should be conducted only by an individual or firm that could be qualified as an expert in traffic engineering.

Upon submission of a draft traffic impact analysis report, the county and VDOT will review the study data sources, methods, and findings and provide comments. The applicant will then have the opportunity to incorporate necessary revisions prior to submitting a final report to public officials. Accompanying the applicant's submission will be written comments of local and state staff. This information will then be used to reach a decision regarding the proposed development.

C. DETERMINING THE NEED FOR A TRAFFIC IMPACT STUDY

The reviewing agencies should have the discretion to determine when a traffic impact study is needed. The need for a traffic impact study should be evaluated based on conditions surrounding the individual development. The site specific conditions that should be considered include:

1. The potential impact upon the local and regional road networks.
2. The capacity and level of service of the existing roadways to be entered.
3. Roadway geometrics.
4. The type and size of the proposed development.
5. Traffic operations of one or more intersections.
6. Issues of safety and/or traffic operation within the public right of way.

VDOT and the county should consider requesting that a group of developers jointly sponsor a traffic impact study on a section of highway where many independent developments are planned.

D. TRAFFIC IMPACT STUDY CONTENTS AND SPECIFICATIONS

The contents were primarily adopted from VDOT "Guidelines for Traffic Impact Study--Final Report," prepared by Simpson and Curtin, April 1979, and "Guidelines for Traffic Impact Studies in James City County."

1. Format

A traffic impact study prepared for a specific site proposal should follow the chapter format shown in Table C-7-1. Wherever additions or modifications are appropriate for a specific site, they should be made.

2. Capacity and Level of Service Analyses

a. Use of the Highway Capacity Manual

All capacity analyses shall be conducted utilizing the procedures in the current Highway Capacity Manual (Special Report 209), Transportation Research Board.

1. INTRODUCTION

- A. Site and Study Area Boundaries
- B. Existing and Proposed Site Uses
- C. Existing and Proposed Nearby Uses
- D. Existing and Proposed Roadways and Intersections

2. ANALYSIS OF EXISTING CONDITIONS

- A. Daily and Peak Hour(s) Traffic Volumes
- B. Capacity Analyses at Critical Points
- C. Levels of Service at Critical Points

3. ANALYSIS OF FUTURE CONDITIONS WITHOUT DEVELOPMENT

- A. Daily and Peak Hour(s) Traffic Volumes
- B. Capacity Analyses at Critical Points
- C. Levels of Service at Critical Points

4. TRIP GENERATION

5. TRIP DISTRIBUTION

6. TRAFFIC ASSIGNMENT

7. ANALYSIS OF FUTURE CONDITIONS WITH DEVELOPMENT

- A. Future Daily and Peak Hour(s) Traffic Volumes
- B. Capacity Analyses at Critical Points
- C. Levels of Service at Critical Points

- 8. RECOMMENDED IMPROVEMENTS
 - A. Proposed Recommended Improvements
 - B. Capacity Analyses at Critical Points
 - C. Levels of Service at Critical Points

- 9. CONCLUSION

For capacity analysis and level of service determinations, the most recent Federal Highway Administration software package should be used for the different types of analysis required (e.g., signalized intersections, freeways, ramps). CAPCALC 85 may also be used for analyzing intersections. Regardless of which software package is used, the results should be reviewed for reasonableness. Other software, if approved by the county and VDOT in advance, may be used.

Consultants may use any of a number of software packages available for capacity analysis. They should provide the input data as well as the results of the capacity analysis so that VDOT may check the results with its own analysis. Where a great number of intersections or road sections are analyzed, a sample of those should be checked by performing the analysis and comparing results. Where differences occur, the consultant should be required to explain the differences, and all road sections and intersections should be reviewed closely.

- b. Level of Service

Level of Service C will be the design objective, and under no circumstances will less than Level of Service D for all approaches of an intersection be accepted for on-site and off-site traffic. This criterion, however, may be modified by the county and VDOT on a case-by-case basis, depending on traffic conditions in the proposed site vicinity.

- c. Use of Results of Level of Service Studies

1. The primary function of a level of service study is the determination of the geometrics required to provide a desired level of service in a design year.
2. The number of lanes required on either a through road or at an intersection can be determined, and the need for auxiliary lanes, as well as their length, can be established.
3. The need for signalization can be determined from the projected traffic volumes and the signal warrants in the Manual on Uniform Traffic Control Devices for Street and Highways (MUTCD).

4. The level of service study can indicate where on-street parking will have to be eliminated or restricted in order to achieve a desired level of service.
5. When a development in a given area is projected to be phased over a long period of time, stage construction should be considered and a level of service study used to determine when the various stages must be completed.

3. Narrative

A brief narrative for each chapter of the traffic impact study follows.

CHAPTER 1. INTRODUCTION

- A. **Site and Study Area Boundaries**
Include a brief description of and a map displaying the size of the land parcel, the general terrain features, and the location within the jurisdiction and region. In addition, identify the roadways that afford access to the site and are included in the study area. The exact limits of the study area should be based on engineering judgment and an understanding of the existing traffic conditions in the site vicinity. In all instances, however, the study area limits will be discussed with the applicant and his traffic engineer and will be determined by the county and VDOT staff. The definition of the study area should result, subsequent to the initial staff review of a developer's rezoning application or preliminary site plan, at which time a traffic impact study will be required. If the project is being completed in phases, describe the total project and the phases. The study should address the appropriate phase.
- B. **Existing and Proposed Site Uses**
Identify the existing and proposed uses of the site in terms of the various zoning categories. In addition, identify the number and the type of residential units, and type and amount of commercial, industrial, or office uses in accordance with ITE trip generation categories.
- C. **Existing and Proposed Nearby Uses**
Include a complete description of the existing land uses in the vicinity of the site, as well as their current zoning. Also state the proposed developments of adjacent land using the county's comprehensive land use plan. This is especially important where large tracts of underdeveloped land are in the vicinity of the site and are within a prescribed study area.

- D. **Existing and Proposed Roadways and Intersections**
Describe and provide diagrams of the existing roadways and intersections (including road geometrics, lane usage, traffic control, and intersection condition diagrams) within the study area as well as improvements contemplated by the county and state. This includes the nature of the improvement project, its extent, the implementation schedule, and the agency or funding source responsible.

CHAPTER 2. ANALYSIS OF EXISTING CONDITIONS

- A. **Daily and Peak Hour(s) Traffic Volumes**
Present diagrams depicting daily and peak hour traffic volumes for roadways within the study area. Present turning movement and mainline volumes for the three peak hour conditions (a.m., p.m., and site-generated). Present only mainline volumes to reflect daily traffic volumes. Also present the source and/or the method of computation for all traffic volumes.
- B. **Capacity Analyses at Critical Points**
Utilizing techniques as described in the current Highway Capacity Manual, assess the relative balance between roadway volumes and capacity. Analyze existing conditions (roadway geometrics and traffic signal control) for all peak hours.
- C. **Level of Service at Critical Points**
Based on the results obtained in the previous section, determine and present levels of service (A through F). Include a description of typical operating conditions at each level of service.

CHAPTER 3. ANALYSIS OF FUTURE CONDITIONS WITHOUT DEVELOPMENT

Describe the anticipated traffic volumes in the future and the ability of the roadway network to accommodate this traffic without the proposed zoning or subdivision request. The future year(s) for which projections are made will be specified by the county or VDOT staff and will depend on the timing of the proposed development.

- A. **Future Daily and Peak Hour(s) Traffic Volumes**
Indicate clearly the method and assumptions used to forecast future traffic volumes so that the county and VDOT staff can replicate these calculations.

- B. Capacity Analyses at Critical Locations
Describe the ability of the existing roadway system to accommodate future traffic (without site development) for all peak hours using the current Highway Capacity Manual. If roadway improvements or modifications are committed for implementation, present the capacity analysis for these conditions.
- C. Levels of Service at Critical Points
Based on the results obtained in the previous section, determine the levels of service (A through F).

CHAPTER 4. TRIP GENERATION

Present and diagram the amount of traffic generated by the site for daily and three peak hour conditions. Trip generation rates to be used should be those presented in Trip Generation, 4th ed, Institute of Transportation Engineers. Deviation from these rates must be justified and documented to the satisfaction of the county and VDOT.

CHAPTER 5. TRIP DISTRIBUTION

Present and diagram the direction of approach for site-generated traffic for the appropriate time periods. The basic method and assumptions used must be clearly stated so that the county and VDOT can replicate these results.

CHAPTER 6. TRAFFIC ASSIGNMENT

Describe the utilization of study area roadways by site-generated traffic. Combine the proposed traffic volumes with the anticipated traffic volumes from Chapter 3 to describe and diagram mainline and turning movement volumes for future conditions with the site developed as proposed. Clearly state the basic method and assumptions used.

CHAPTER 7. ANALYSIS OF FUTURE CONDITIONS WITH DEVELOPMENT

- A. Future Daily and Peak Hour(s) Traffic Volumes
Present and diagram mainline and turning movement volumes for the highway network in the study area, as well as driveways and internal circulation roadways for all time periods.

- B. Capacity Analysis at Critical Points
Perform a capacity analysis for all peak hours for future conditions with the site developed as proposed using the current Highway Capacity Manual.
- C. Levels of Service at Critical Points
As a result of the capacity analysis, compute and describe the level of service on the study area roadway system.

CHAPTER 8. RECOMMENDED IMPROVEMENT

In the event the analysis indicates that unsatisfactory levels of service will occur on study area roadways, describe the improvement proposed to remedy deficiencies. The proposals would identify committed projects by the county and state that were described in Chapter 1 and reflected in the analysis contained in Chapters 2 and 3.

- A. Proposed Recommended Improvements
Clearly describe and diagram the location, nature, and extent of proposed improvements to ensure sufficient roadway capacity. Accompanying this list of improvements should be preliminary cost estimates, source of funding, timing, and likelihood of implementation.
- B. Capacity Analysis at Critical Points
Describe the anticipated results of making these improvements.
- C. Levels of Service at Critical Points
As a Result of the revised capacity analyses presented in the previous section, present the levels of service for the roadway system with improvements.

CHAPTER 9. CONCLUSION

The last chapter of the report should be a clear, concise description of the study findings. This concluding chapter should serve as an executive summary.

IV. ROLES OF VDOT OFFICES IN SITE PLAN REVIEW

A. RESIDENCY OFFICES

(This description is not applicable for residencies in Northern Virginia where the district office is the primary entry point for site plans.)

1. Log in all preliminary site plans and rezoning applications and site plans from the county. In counties without an engineering or planning staff, the residency may receive plans from the developer or his representative. The residency office is a clearinghouse for site plans and traffic impact studies. Any site plans sent directly to the district or central office should be returned to the appropriate residency.
2. Check the site plan for completeness using the appropriate checklist, either the checklist for the preliminary site plan or for site plan completeness.
3. Return incomplete site plans to or contact the sender noting the deficiencies to be corrected.
4. For completed site plans, determine if the plan should be forwarded to the appropriate district office section for either drainage or traffic review or both. The factors considered in this determination include:
 - a. The capabilities of the residency staff.
 - b. The size of the development.
 - c. The level of service on the existing highways that will provide access.
 - d. The complexity of the drainage system design.
 - e. The residency staff has questions on the site plan.
5. Perform the site plan review using the site plan review checklist and prepare written review comments, or forward the site plan to the appropriate district office section(s) for review with issues of particular concern noted. If both areas are reviewed, jointly address both review persons in the cover letter. Wait to receive their comments.
6. Forward all traffic impact studies to the district traffic engineering section.
7. Forward the review comments to the county staff or developer or his representative.
8. Coordinate site plan review activities with the county and, if appropriate, with the district.

B. DISTRICT OFFICES

1. Log in the rezoning applications and site plans received from the residency.
2. If appropriate, coordinate activities between the district sections reviewing the plan, primarily the hydraulics and traffic engineering section.
3. Determine if the application or site plan should be forwarded to the central office for a partial or complete review, or not at all. The factors considered in this determination include:
 - a. The size of the development.
 - b. The level of service on the existing highways that will provide access.
 - c. Impact on an interstate road.
 - d. The complexity of the road and drainage designs.
 - e. The development impacts on roads with major improvements planned.
 - f. A policy change is needed.
 - g. The district staff has questions on the plan.
4. For plans to be reviewed in the central office:
 - a. For a complete review, forward the plan to the head of the Location and Design Division, indicate the divisions that should review the plan, and flag issues of special concern.
 - b. For a partial review, forward the plan to the head of the division that should review the plan and flag issues of particular concern. Send a copy of the letter to the head of the Location and Design Division. Wait to receive their comments.
5. Perform the site plan review using the Site Plan Review Checklist and prepare written review comments.
6. For a traffic impact study:
 - a. Check for adherence to the guidelines for a traffic impact study.
 - b. If the study does not satisfy the guidelines, return it to the initial sender, either the county or the preparer of the study.

- c. If the study is acceptable, determine if the study should be reviewed by the Transportation and Mobility Planning Division. The factors to be considered are outlined in item 3 above for the district office.
 - d. Perform the review and prepare written comments or forward the review to the Transportation and Mobility Planning Division, flagging issues of concern, and wait for their comments.
7. When comments on a plan or traffic impact study are received, review the comments, then forward the review comments to the residency, including any comments from the district and a note stating which office should review the revised site plan when it is submitted.

C. CENTRAL OFFICE

1. Log in rezoning applications and site plans from the district offices.
2. For complete plan reviews by the central office, the Location and Design Division will coordinate the review with the related divisions as requested by the district office. The Location and Design Division is responsible for forwarding the plans to the appropriate divisions, compiling the review comments from the divisions, and forwarding the comments to the district offices.
3. For partial reviews by the central office, the reviewing division receives the plan from the district office and reviews the plan using the Site Plan Review Checklist, and other references deemed appropriate by the division, and prepares a written response that is forwarded to the district. The areas of site plan review responsibility for the divisions are:

Location and Design: (a) reviews road geometrics and entrance designs, (b) reviews drainage designs, and (c) examines how the proposed site may impact planned road projects.

Transportation and Mobility Planning Division: (a) reviews plans for traffic impact on existing roads and planned road improvements, especially the capacity analysis, and (b) reviews traffic impact studies.

Traffic Engineering Division: evaluates unusual proposals or extenuating circumstances for compliance with the subdivision street requirements.

Local Assistance Division: evaluates unusual proposals or extenuating circumstances for compliance with the subdivision street requirements.

Asset Management Division: serves as a clearinghouse for complaints of betterment when a developer who views VDOT's requirements as excessive submits a request to the Commission to review his complaint.

Materials Division: (a) occasionally reviews pavement structures, and (b) reviews the geotechnical plans of roadway dams.

On rare occasions, other divisions may be requested to review a particular aspect of the site plan that involves their areas of responsibility.

D. SITE PLAN REVIEW PROCESS THROUGH VDOT

Figures C-7-1 and C-7-2 illustrate the flow of site development plans and subdivision plans, respectively, through the VDOT. In both cases, all plans should be submitted to the residency to initiate VDOT review (except for Northern Virginia where the district is the entry point).

Figure C-7-1 shows the plan flow through VDOT for partial site plan reviews. Figure C-7-2 shows the flow for complete reviews by the next level.

Figure C-7-3 is from the draft of "Subdivision Street Requirements."

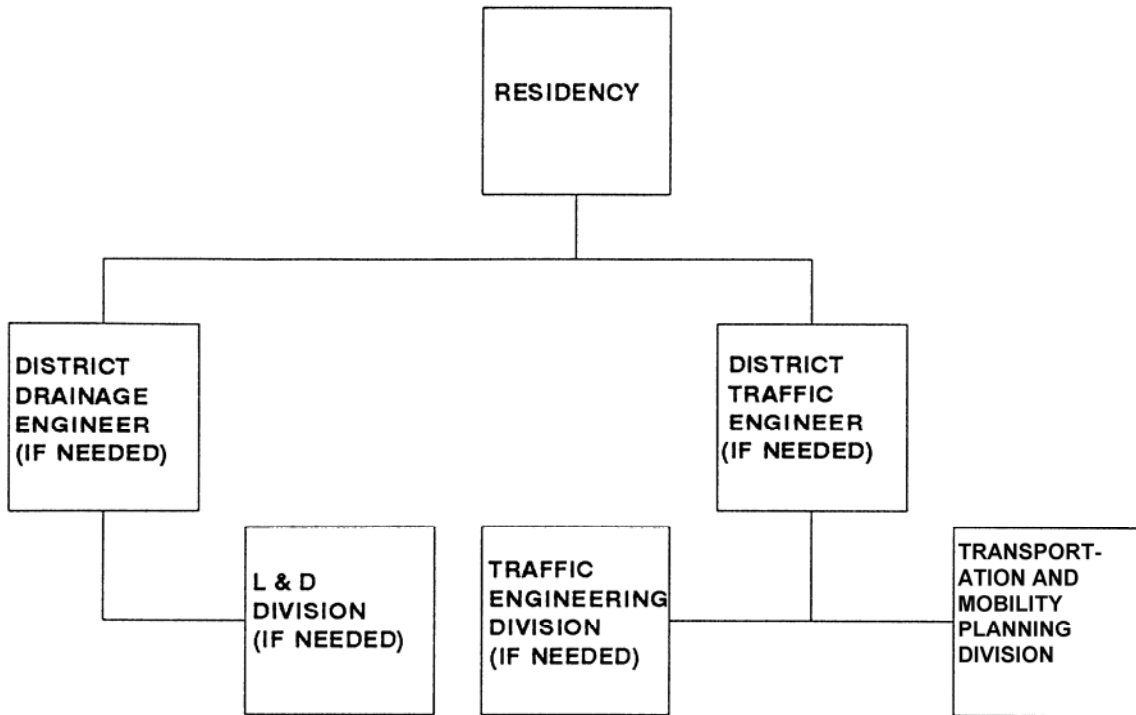

FIGURE C-6-1 PARTIAL SITE PLAN PREVIEW PROCESS

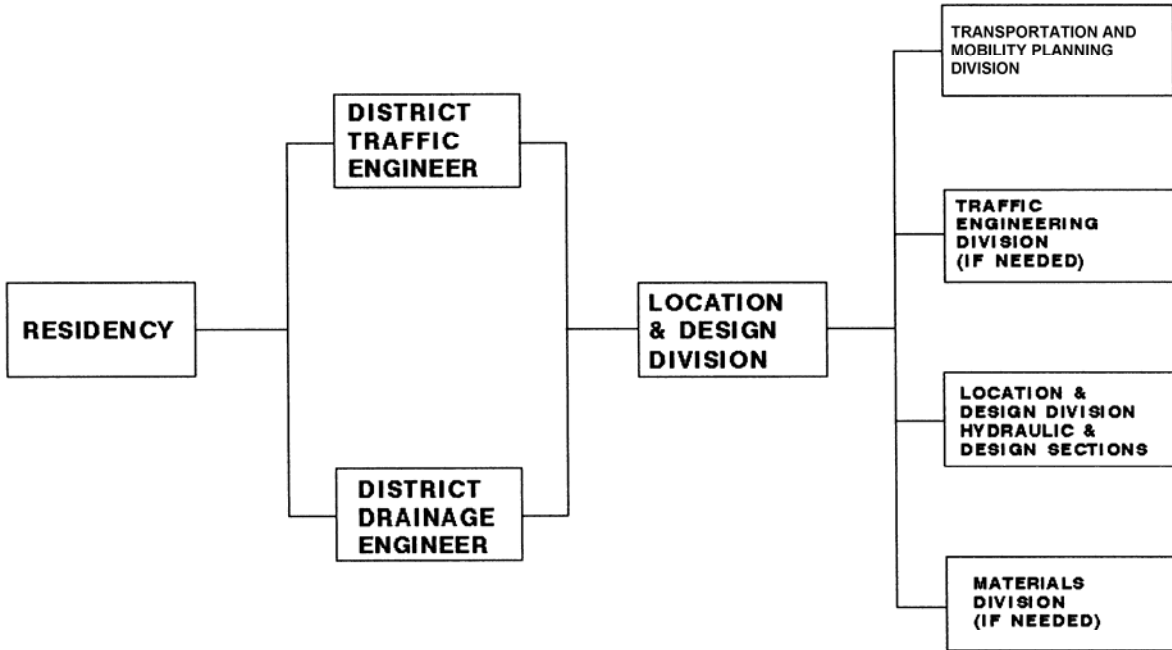

FIGURE C-6-2 COMPLETE SITE PLAN REVIEW PROCESS

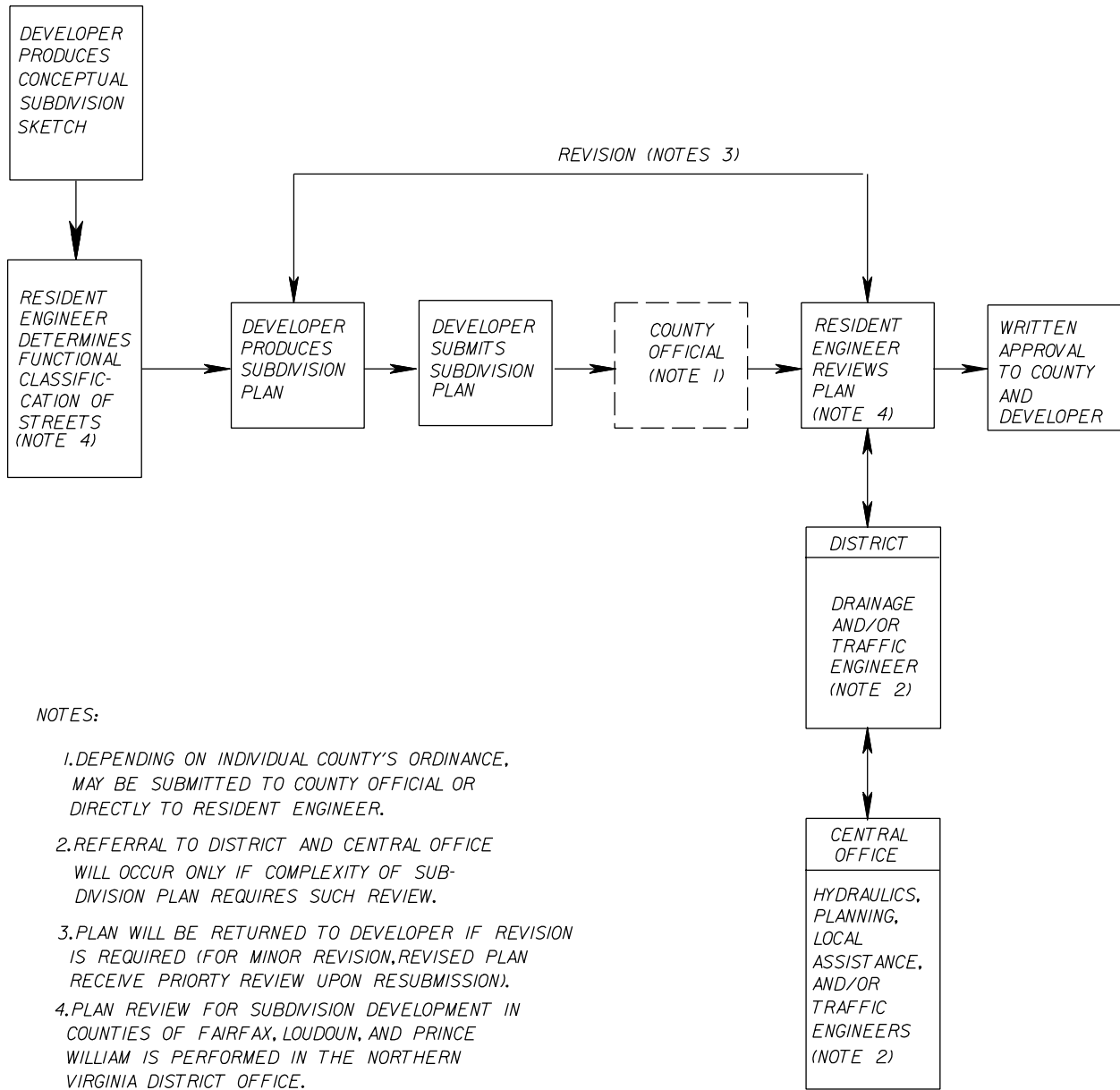

FIGURE C-6-3 SUBDIVISION STREET PLAN REVIEW PROCEDURE

V. COORDINATION WITH COUNTY GOVERNMENTS IN SITE PLAN REVIEW

The previous sections of the guide emphasized site plan review activities within VDOT. Coordination and communication with the county governments are strongly encouraged and should be responsive to the needs of the county and the respective residency and/or district offices. Communication between VDOT and the counties is important in facilitating site plan review activities and in resolving problems and misunderstandings. Agreement on county and VDOT interaction with the developer should be obtained. With the exception of Northern Virginia, a VDOT residency staff person should be designated to serve as a liaison with the county.

The field offices and counties are strongly encouraged to document their site plan review process. In this way, the process will be clearly outlined on paper to facilitate mutual understanding and expectations of the site plan review process. The process of developing the document will provide opportunities to resolve problems and misunderstandings. Updates or revisions of the process should be made as needed.

The field offices and counties should each have updated copies of all of the other's documents pertinent to site plan review.

SPIRAL CURVES

In order to approximate the path a vehicle makes when entering or leaving a circular horizontal curve, a spiral transition curve will be provided for horizontal curves with a radius less than or equal to 2865 feet, except for interchange ramps and loops.

The spiral to be used is known as the Talbot Transition Spiral and has the following characteristics:

1. - The radius of the spiral at any point is inversely proportional to its length. The radius at the TS (beginning of the spiral) is infinite and at the SC (end of the spiral) is equal to the radius of the circular curve R.

R radius of the circular curve
r radius at the distance L_x from TS
LS length of spiral

$$R \div r = L_x \div LS$$

2. - The central angle of a spiral curve is exactly 1/2 of a circular curve with the same radius and length.

DE = central angle of spiral

$$DE = (28.6479 \times LS) \div R$$

3. - Spiral angles are directly proportional to the squares of their lengths from the TS.

Δ_L central angle for spiral for a length

L_x from TS

$$\Delta_L = (L_x \div LS)^2 \times DE$$

Formulas for computing spiral curve information is shown on the following two pages.*

* Rev. 1/07

TRANSITION (SPIRAL) CURVES

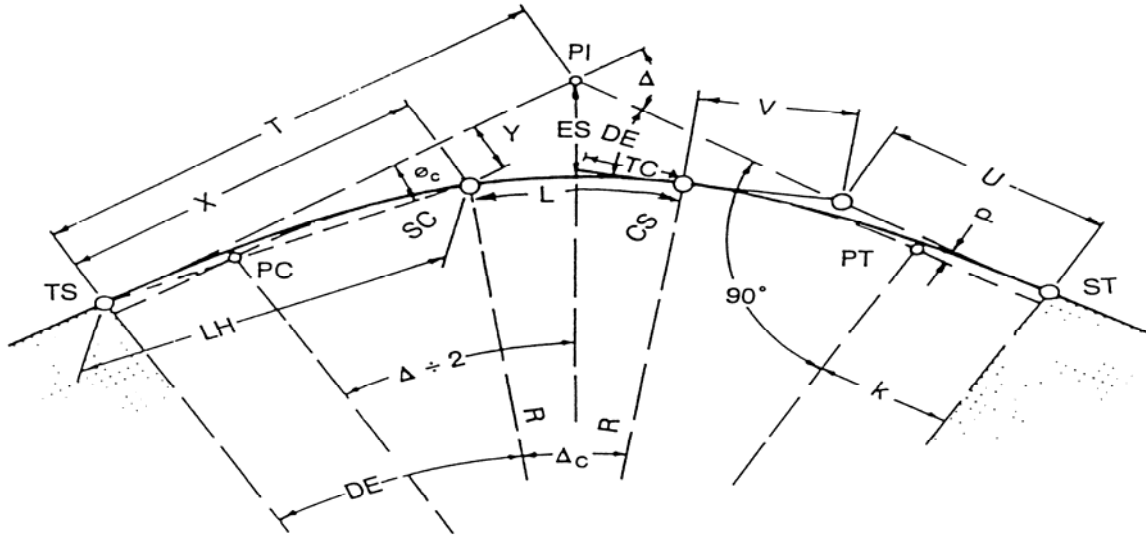

- | | | | |
|------------------|---------------------------------------|------------------|-----------------------------------|
| LS = | Length of Spiral | V = | Short Tangent |
| L = | Length of Circular Curve | X = | Tangent Distance for SC |
| R = | Radius of Circular Curve | Y = | Tangent Offset of the SC |
| TC = | Tangent of Circular Curve | k = | Simple Curve Coordinate(Abscissa) |
| T = | Tangent Distance | P = | Simple Curve Coordinate(Ordinate) |
| Δ = | Deflection Angle Between the Tangents | ∅ _c = | Deflection Angle of Spiral Curve |
| DE = | Spiral Angle | TS = | Tangent to Spiral |
| Δ _c = | Central Angle Between the SC and CS | SC = | Spiral to Circular Curve |
| ES = | External Distance | CS = | Circular Curve to Spiral |
| LH = | Long Chord | ST = | Spiral to Tangent |
| U = | Long Tangent | | |

SPIRAL CURVE FORMULAS

DE =	$(28.6479 \times LS) \div R$	TC =	$R \times [\tan (\Delta_c \div 2)]$
Z =	$0.01745 \times DE$	Δ _c =	$\Delta - (2 \times DE)$
X =	$LS \times [1 - (Z^2 \div 10) + (Z^4 \div 216)]$	p =	$Y - [R \times (1 - \cos DE)]$
Y =	$LS \times [(Z \div 3) - (Z^3 \div 42) + (Z^5 \div 1320)]$	k =	$X - [R \times (\sin DE)]$
L =	$(R \times \Delta_c) \div 57.2958$		

TO CALCULATE T AND ES OF A SIMPLE CURVE WITH EQUAL SPIRALS

$$T = [(R + p) \times \tan (\Delta \div 2)] + k$$

$$ES = [(R + p) \times \operatorname{Exsec} (\Delta \div 2)] + p$$

$$ES = [(R + p) \div \cos (\Delta \div 2)] - R$$

TO CALCULATE THE TANGENT DISTANCES OF A SIMPLE CURVE WITH UNEQUAL SPIRALS

$$T_{in} = [(R + P)_2 \div \sin \Delta] - [(R + p)_1 \times \cot \Delta] + k_1$$

$$T_{out} = [(R + p)_1 \div \sin \Delta] - [(R + p)_2 \times \cot \Delta] + k_2$$

FIGURE C-6-4 TRANSITION (SPIRAL) CURVES

TO FIND COORDINATES OF ANY POINT ON THE SPIRAL
A DISTANCE L_x FROM THE TS

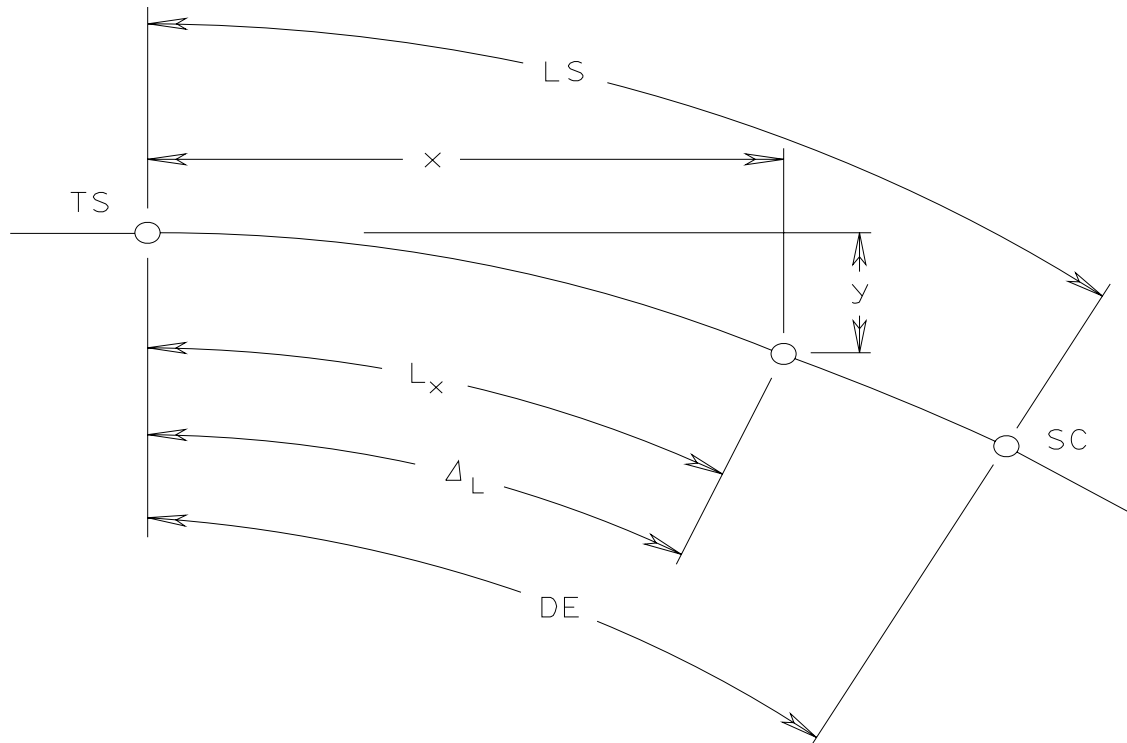

$$DE = (28.6479 \times LS) \div R = (90 \times LS) \div (\pi \times R)$$

$$\Delta_L = (L_x \div LS)^2 \times DE$$

$$Z_L = 0.01745 \times \Delta_L$$

$$x = L_x \times [1 - (Z_L^2 \div 10) + (Z_L^4 \div 216)]$$

$$y = L_x \times [(Z_L \div 3) - (Z_L^3 \div 42) + (Z_L^5 \div 1320)]^*$$

FIGURE C-6-5 COORDINATE POINTS ON THE SPIRAL

* Rev. 1/07

**HORIZONTAL CURVES EXAMPLE
(Not to Scale)**

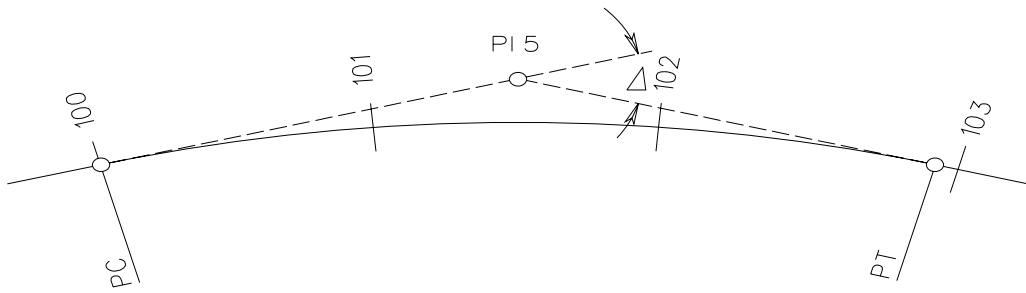

Lane A
 PI NO. 5
 DELTA = 18° 26' 40" RT
 T = 146.126
 L = 289.725
 R = 900.000
 PC = 100+00.000
 PI = 101+46.126
 PT = 102+89.725
 V = 90 km/h
 E = 3.1%

URBAN - NO SPIRAL TRANSITION

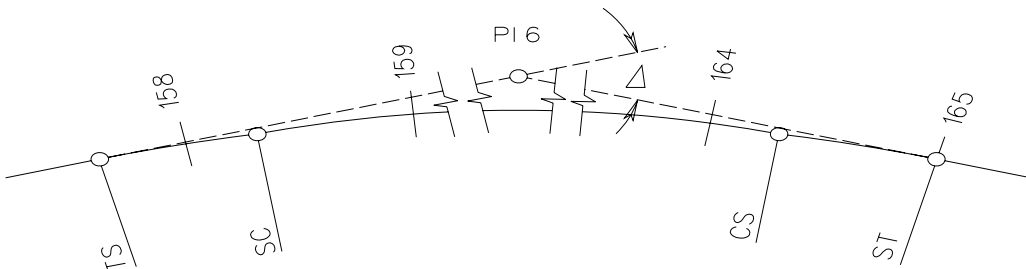

Lane A
 PI NO. 6
 DELTA = 54° 49' 28" RT
 T = 395.663
 L = 604.807
 R = 700.000
 LSIN = 65.000
 LSOUT = 65.000
 TS = 157+64.500
 SC = 158+29.500
 PI = 161+60.163
 CS = 164+34.307
 ST = 164+99.307
 V = 100 km/h
 E = 6.3%

RURAL - WITH SPIRAL TRANSITION*

FIGURE C-6-6 HORIZONTAL CURVES EXAMPLE

* Rev. 1/07

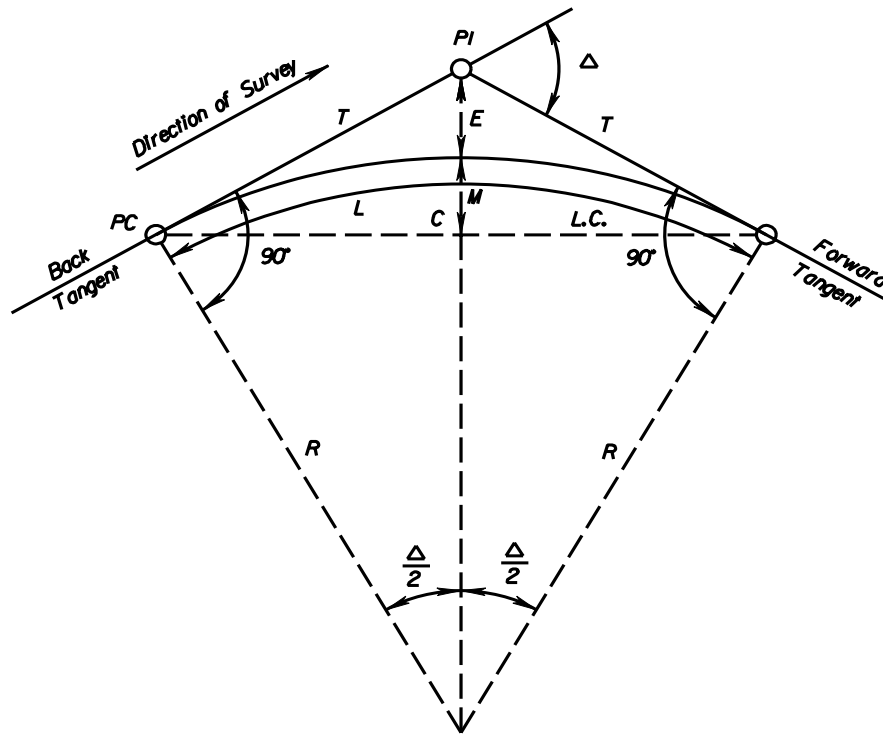

LEGEND

- P. I. - Point of Intersection
- P. C. - Point of Curvature
- P. T. - Point of Tangency
- Δ - Deflection Angle Between the Tangents
- T - Tangent Distance
- E - External Distance
- R - Radius of the Circular Arc
- M - Middle Ordinate
- L. C. - Long Chord (Distance Between P. C. and P. T.)
- C - Midpoint of Long Chord
- D - Degree of Curvature
- L - Length of Curve

FORMULAS FOR ARC DEFINITION

- $\Delta = \frac{DL}{100}$
- $D = \frac{5729.58}{R}$
- $T = R \tan \frac{\Delta}{2}$
- $L = \frac{100 \Delta}{D}$
- $R = \frac{5729.58}{D}$
- $E = T \tan \frac{\Delta}{4} = R \sec \frac{\Delta}{2} - R = R \operatorname{exsec} \frac{\Delta}{2}$
- $M = R \operatorname{Vers} \frac{\Delta}{2}$
- $L. C. = 2 R \sin \frac{\Delta}{2}$
- Locating the P. C. and P. T.
- Sta. P. C. = Sta. P. I. - T
- Sta. P. T. = Sta. P. C. + L

FIGURE C-6-7 SIMPLE CURVE COMPUTATIONS*

* Rev. 7/07

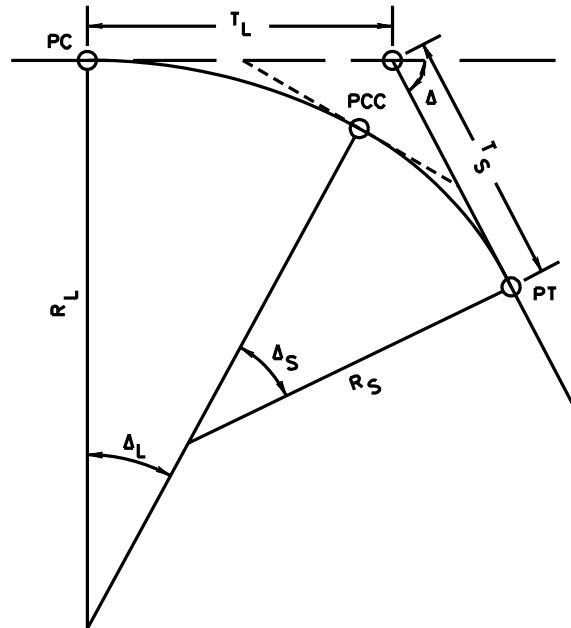

<u>GIVEN</u>	<u>SOLUTION</u>	<u>LEGEND</u>
$\Delta_L, \Delta_S, T_S, R_S$	$R_L = \frac{T_S \sin \Delta - R_S \text{Vers } \Delta}{\text{Vers } \Delta_L} \cdot R_S$	P. C. - Point of Curvature
$\Delta_L, \Delta_S, T_L, R_L$	$R_S = \frac{T_L \sin \Delta - R_L \text{Vers } \Delta}{\text{Vers } \Delta_S} \cdot R_L$	P. C. C. - Point of Compound Curvature
$\Delta_L, \Delta_S, R_L, R_S$	$T_L = \frac{R_L \text{Vers } \Delta - \sin \Delta}{(R_L - R_S) \text{Vers } \Delta_S}$	P. T. - Point of Tangency
$\Delta_L, \Delta_S, T_S, R_L$	$R_S = \frac{T_S \sin \Delta - R_L \text{Vers } \Delta_L}{\text{Vers } \Delta - \text{Vers } \Delta_L}$	R_L - Radius of Major Curve
$\Delta_L, \Delta_S, T_L, R_S$	$R_L = \frac{R_S \text{Vers } \Delta_S - T_S \sin \Delta}{\text{Vers } \Delta_S - \text{Vers } \Delta}$	R_S - Radius of Minor Curve
$\Delta_L, \Delta_S, T_L, T_S$	$R_S = \frac{T_S \sin \Delta - \tan \frac{1}{2} \Delta_L (T_L \cdot T_S \cos \Delta)}{\text{Vers } \Delta - \sin \Delta \tan \frac{1}{2} \Delta_L}$	T_L - Long Tangent
Δ, T_L, T_S, R_S	$\tan \frac{1}{2} \Delta_L = \frac{T_S \sin \Delta - R_S \text{Vers } \Delta}{T_L \cdot T_S \cos \Delta - R_S \sin \Delta}$	T_S - Short Tangent
Δ, T_L, T_S, R_L	$\tan \frac{1}{2} \Delta_S = \frac{R_L \text{Vers } \Delta - T_L \sin \Delta}{R_L \sin \Delta - T_L \cos \Delta - T_S}$	Δ - Total deflection Angle of the Compound Curve = $\Delta_L + \Delta_S$
Δ, T_S, R_L, R_S	$\cos \Delta_L = \frac{R_L - T_S \sin \Delta - R_S \cos \Delta}{R_L - R_S}$	Δ_L - Deflection Angle of Major Curve
Δ, T_L, R_L, R_S	$\text{Vers } \Delta_S = \frac{R_L \text{Vers } \Delta - T_L \sin \Delta}{R_L - R_S}$	Δ_S - Deflection Angle of Minor Curve
		$\text{Vers} = 1 - \cos$

FIGURE C-6-8 COMPOUND CURVE COMPUTATIONS*

* Rev. 7/07

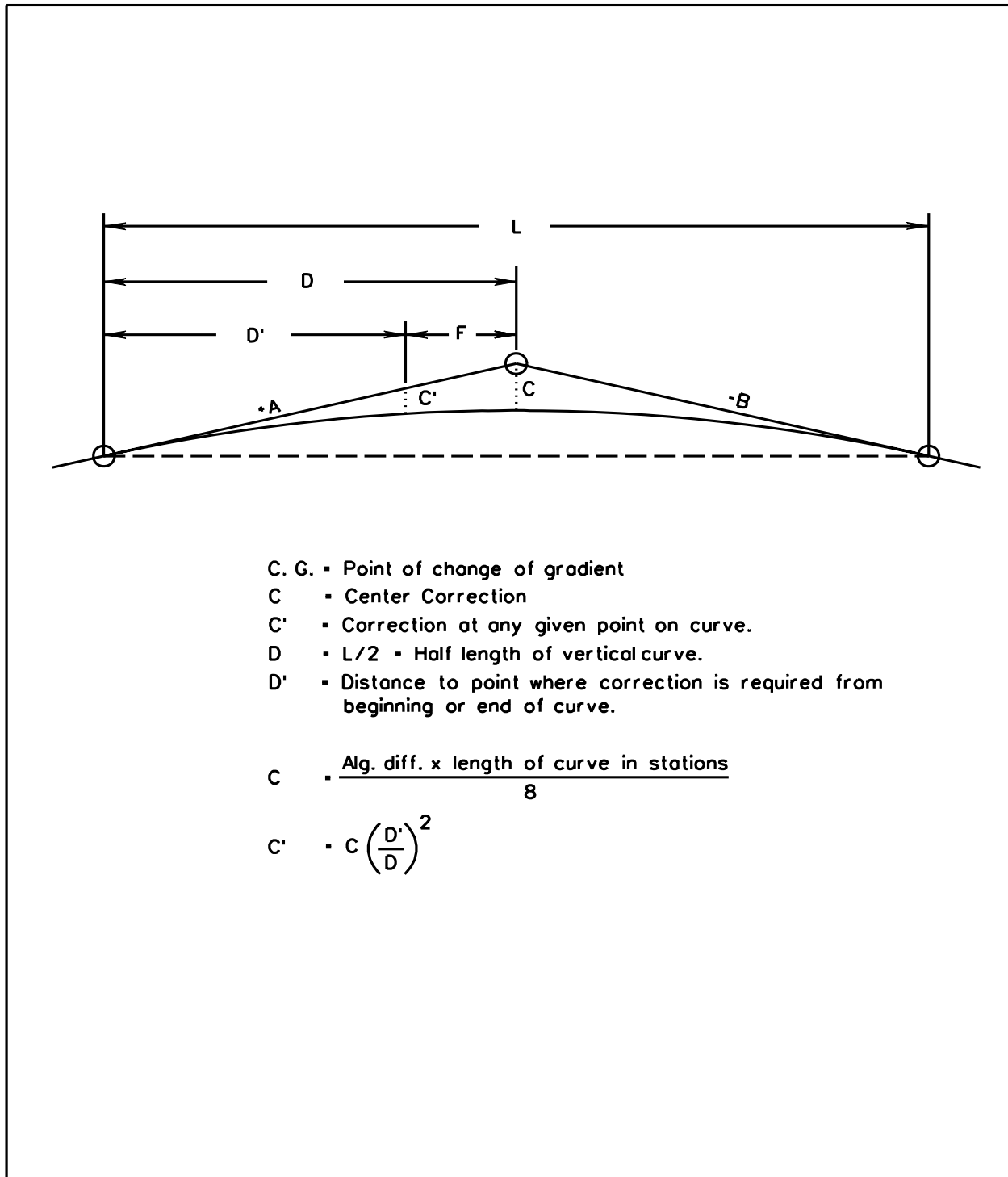

FIGURE C-6-9 PARABOLIC VERTICAL CURVE COMPUTATIONS*

* Rev. 7/07

Inches	0	1	2	3	4	5	6	7	8	9	10	11
0	.0000	.0833	.1667	.2500	.3333	.4167	.5000	.5833	.6667	.7500	.8333	.9167
$\frac{1}{16}$.0052	.0885	.1719	.2552	.3385	.4219	.5052	.5885	.6719	.7552	.8385	.9219
$\frac{1}{8}$.0104	.0938	.1771	.2604	.3438	.4271	.5104	.5938	.6771	.7604	.8438	.9271
$\frac{3}{16}$.0156	.0990	.1823	.2656	.3490	.4323	.5156	.5990	.6823	.7656	.8490	.9323
$\frac{1}{4}$.0208	.1042	.1875	.2708	.3542	.4375	.5208	.6042	.6875	.7708	.8542	.9375
$\frac{5}{16}$.0260	.1094	.1927	.2760	.3594	.4427	.5260	.6094	.6927	.7760	.8594	.9427
$\frac{3}{8}$.0313	.1146	.1979	.2813	.3646	.4479	.5313	.6146	.6979	.7813	.8646	.9479
$\frac{7}{16}$.0365	.1198	.2031	.2865	.3698	.4531	.5365	.6198	.7031	.7865	.8698	.9531
$\frac{1}{2}$.0417	.1250	.2083	.2917	.3750	.4583	.5417	.6250	.7083	.7917	.8750	.9583
$\frac{9}{16}$.0469	.1302	.2135	.2969	.3803	.4635	.5469	.6302	.7135	.7969	.8802	.9635
$\frac{5}{8}$.0521	.1354	.2188	.3021	.3854	.4688	.5521	.6354	.7188	.8021	.8854	.9688
$\frac{11}{16}$.0573	.1406	.2240	.3073	.3906	.4740	.5573	.6406	.7240	.8073	.8906	.9740
$\frac{3}{4}$.0625	.1458	.2292	.3125	.3958	.4792	.5625	.6458	.7292	.8125	.8958	.9792
$\frac{13}{16}$.0677	.1510	.2344	.3177	.4010	.4844	.5677	.6510	.7344	.8177	.9010	.9844
$\frac{7}{8}$.0729	.1563	.2396	.3229	.4063	.4896	.5729	.6563	.7396	.8229	.9063	.9896
$\frac{15}{16}$.0781	.1615	.2448	.3281	.4115	.4948	.5781	.6615	.7448	.8281	.9115	.9948

TABLE C-6-1
INCHES AND FRACTIONS OF AN INCH IN DECIMALS OF A FOOT*

* Rev. 7/07

SIN	$\frac{\text{Opposite Side}}{\text{Hypotenuse}}$	TAN	$\frac{\text{Opposite Side}}{\text{Adjacent Side}}$	SEC	$\frac{\text{Hypotenuse}}{\text{Adjacent Side}}$
COS	$\frac{\text{Adjacent Side}}{\text{Hypotenuse}}$	COT	$\frac{\text{Adjacent Side}}{\text{Opposite Side}}$	CSC	$\frac{\text{Hypotenuse}}{\text{Opposite Side}}$

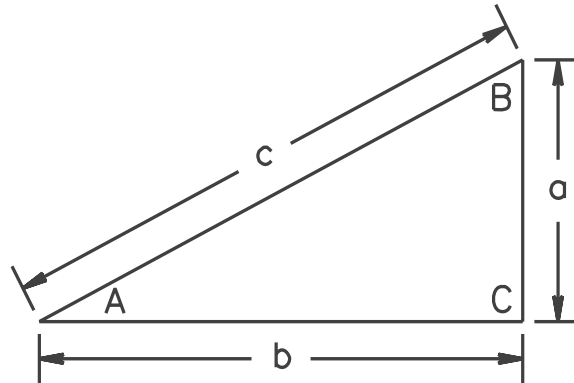

Find	Given	Formula	Find	Given	Formula
SIN A	Sides a, c	$\frac{a}{c}$	SIDE b	Side a, Tan A	$\frac{a}{\text{Tan A}}$
SIN A	Cos A, Tan A	Cos A, Tan A	SIDE C	Side a, b	$\sqrt{a^2 + b^2}$
SIN A	Cos A	$\sqrt{1 - \text{Cos}^2 A}$	SIDE C	Side a, Sin A	$\frac{a}{\text{Sin A}}$
COS A	Sides b, c	$\frac{b}{c}$	SIDE C	Side b, Cos A	$\frac{b}{\text{Cos A}}$
COS A	Sin A, Tan A	$\frac{\text{Sin A}}{\text{Tan A}}$	TAN A	Sin A, Cos A	$\frac{\text{Sin A}}{\text{Cos A}}$
COS A	Sin A	$\sqrt{1 - \text{Sin}^2 A}$	TAN A	Sides a, b	$\frac{a}{b}$
SIDE a	Sides b, c	$\sqrt{c^2 - b^2}$	ANGLE A	Angles B, C	C - B
SIDE a	Sides c, Sin A	c Sin A	ANGLE B	Angles A, C	C - A
SIDE a	Sides b, Tan A	b Tan A	ANGLE C	Angles A, B	A - B
SIDE b	Sides a, c	$\sqrt{c^2 - a^2}$			
SIDE b	Sides c, Cos A	c Cos A			

FIGURE C-6-10
REFERENCE FORMULAS - 90 DEGREES TRIANGLE*

* Rev. 7/07

Laws of sines	$\frac{a}{\sin A} = \frac{b}{\sin B} = \frac{c}{\sin C}$
Laws of cosines	$a^2 = b^2 + c^2 - 2bc \cos A$ $b^2 = a^2 + c^2 - 2ac \cos B$ $c^2 = a^2 + b^2 - 2bc \cos C$
Laws of tangents	$\frac{a-b}{a+b} = \frac{\tan \frac{1}{2} (A-B)}{\tan \frac{1}{2} (A+B)}$

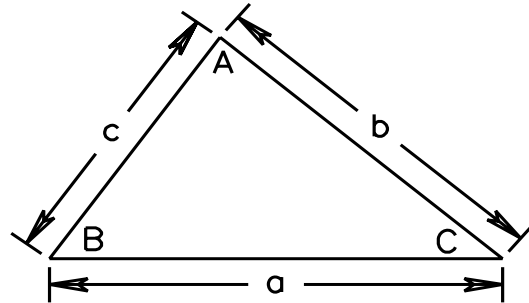

Find	Given	Formula
A	BC	$180^\circ - (B+C)$
sin A	acC	$\frac{a \times \sin C}{c}$
sin A	abB	$\frac{a \times \sin B}{b}$
cos A	abc	$\frac{b^2 + c^2 - a^2}{2bc}$
tan A	acB	$\frac{a \times \sin B}{c - (a \times \cos B)}$
tan A	abC	$\frac{a \times \sin C}{b - (a \times \cos C)}$
B	AC	$180^\circ - (A+C)$
sin B	abA	$\frac{b \times \sin A}{a}$
sin B	bcC	$\frac{b \times \sin C}{c}$
cos B	abc	$\frac{c^2 + a^2 - b^2}{2ac}$
tan B	bcA	$\frac{b \times \sin A}{c - (b \times \cos A)}$
C	AB	$180^\circ - (A+B)$
sin C	acA	$\frac{c \times \sin A}{a}$

Find	Given	Formula
sin C	bcB	$\frac{c \times \sin B}{b}$
cos C	abc	$\frac{a^2 + b^2 - c^2}{2ab}$
tan C	bca	$\frac{c \times \sin A}{b - (c \times \cos A)}$
tan C	acB	$\frac{c \times \sin B}{a - (c \times \cos B)}$
a	cAC	$\frac{c \times \sin A}{\sin C}$
a	bAB	$\frac{b \times \sin A}{\sin B}$
a	bcB	$\sqrt{b^2 + c^2 - (2bc \times \cos A)}$
b	aAB	$\frac{a \times \sin B}{\sin A}$
b	cBC	$\frac{c \times \sin B}{\sin C}$
b	acB	$\sqrt{a^2 + c^2 - (2ac \times \cos B)}$
c	aAC	$\frac{a \times \sin C}{\sin A}$
c	bBC	$\frac{b \times \sin C}{\sin B}$
c	abC	$\sqrt{a^2 + b^2 - (2ab \times \cos C)}$

FIGURE C-6-11 REFERENCE FORMULAS OBLIQUE TRIANGLE*

* Rev. 7/07