

## APPENDIX A

### SECTION A-1-GEOMETRIC DESIGN STANDARDS

	<b>Page</b>
INTRODUCTION .....	A-1
ROADWAY WIDTH.....	A-1
DESIGN SPEED.....	A-1
EXCEPTIONS.....	A-2
GEOMETRIC DESIGN STANDARDS FOR RURAL PRINCIPAL ARTERIAL SYSTEM (GS-1) .....	A-5
GEOMETRIC DESIGN STANDARDS FOR RURAL MINOR ARTERIAL SYSTEM (GS-2) .....	A-6
GEOMETRIC DESIGN STANDARDS FOR RURAL COLLECTOR ROAD SYSTEM (GS-3) .....	A-7
GEOMETRIC DESIGN STANDARDS FOR RURAL LOCAL ROAD SYSTEM (GS-4) .....	A-8
GEOMETRIC DESIGN STANDARDS FOR URBAN PRINCIPAL ARTERIAL SYSTEM (GS-5) .....	A-9
GEOMETRIC DESIGN STANDARDS-URBAN MINOR ARTERIAL STREET SYSTEM (GS-6) .....	A-10
GEOMETRIC DESIGN STANDARDS FOR URBAN COLLECTOR STREET SYSTEM (GS-7) .....	A-11
GEOMETRIC DESIGN STANDARDS FOR URBAN LOCAL STREET SYSTEM (GS-8) .....	A-12
GEOMETRIC DESIGN STANDARDS FOR SERVICE ROADS (GS-9) .....	A-13
GEOMETRIC DESIGN STANDARDS FOR INTERCHANGE RAMPS (GS-RM) .....	A-14

### SECTION A-2-CLEAR ZONE GUIDELINES

	<b>Page</b>
INTRODUCTION .....	A-15
TABLE A-2-1 CLEAR ZONE DISTANCES (IN FEET FROM EDGE OF DRIVING LANE) .....	A-16
CLEAR ZONE COST-EFFECTIVENESS ANALYSIS .....	A-17
SHOWING CLEAR ZONES ON TYPICAL SECTIONS.....	A-21
DETERMINING CLEAR ZONE WIDTH .....	A-22
HORIZONTAL CURVE ADJUSTMENTS .....	A-23
NON-RECOVERABLE PARALLEL SLOPES.....	A-25

### SECTION A-3-TRAFFIC BARRIER INSTALLATION CRITERIA

	<b>Page</b>
INTRODUCTION .....	A-27
GUARDRAIL WARRANTS.....	A-27
DETERMINING WARRANTS FOR ROADSIDE BARRIERS .....	A-28
BARRIER TYPE SELECTION .....	A-29
GUARDRAIL INSTALLATION IN URBAN SETTINGS.....	A-31
GUARDRAIL LOCATIONS ON FIELD INSPECTION PLANS .....	A-31
DETERMINING LOCATION OF THE ENDS OF GUARDRAIL.....	A-32
SLOPES FOR APPROACH BARRIERS.....	A-33

FIXED OBJECTS WITHIN DEFLECTION AREA .....	A-34
FIXED OBJECT ATTACHMENT/TRANSITIONS POLICY .....	A-34
ENTRANCES OR CONNECTIONS ADJACENT TO A BRIDGE .....	A-35
GUARDRAIL OVER CULVERT IN FILLS .....	A-35
SHORT GAPS .....	A-35
PONDS OR OTHER BODIES OF WATER .....	A-35
TERMINAL REQUIREMENTS .....	A-35
TERMINAL INSTALLATION .....	A-37
IMPACT ATTENUATORS (CRASH CUSHIONS) .....	A-39
BRIDGES .....	A-41
SECONDARY PROJECTS .....	A-41
SAFETY/MAINTENANCE PROJECTS .....	A-41

**SECTION A-4-GUIDELINES FOR RRR PROJECTS**

	<b>Page</b>
OBJECTIVE .....	A-43
AUTHORITY .....	A-43
DEFINITIONS .....	A-44
PROJECT SELECTION .....	A-45
ELIGIBILITY .....	A-45
ACCIDENT RECORDS .....	A-46
BRIDGE REHABILITATION / REPLACEMENT SELECTION POLICY .....	A-46
ENVIRONMENTAL CONSIDERATIONS .....	A-48
ACCESS CONTROL .....	A-48
PROJECT DEVELOPMENT .....	A-49
ROADWAY AND TRAVELWAY WIDTHS .....	A-49
FUNCTIONAL CLASSIFICATION .....	A-49
DESIGN TRAFFIC VOLUMES .....	A-50
DESIGN SPEED .....	A-50
TERRAIN .....	A-51
SAFETY .....	A-51
GEOMETRIC DESIGN CRITERIA .....	A-54
CLEAR ZONES AND SLOPES .....	A-55
GRADES .....	A-55
CREST VERTICAL CURVES .....	A-55
SAG VERTICAL CURVES .....	A-56
STOPPING SIGHT DISTANCES .....	A-56
HORIZONTAL CURVES .....	A-56
PAVEMENT CROSS SLOPE .....	A-57
SUPERELEVATION REQUIREMENTS .....	A-57
PAVEMENT EDGE DROP .....	A-57
INTERSECTIONS .....	A-58
DESIGN EXCEPTIONS .....	A-58
PLANNING DRAINAGE DESIGN ELEMENTS .....	A-58
REPLACEMENT OR REHABILITATION OF DRAINAGE ELEMENTS .....	A-59
HYDRAULIC CHARACTERISTICS .....	A-59
SAFETY IMPROVEMENTS RELATIVE TO DRAINAGE DESIGN .....	A-60
BRIDGE RESTORATION .....	A-60
BRIDGE REHABILITATION .....	A-61
CULVERT REPLACEMENT .....	A-62
CULVERT REHABILITATION .....	A-62

CULVERT EXTENSIONS .....	A-62
SIGNING, SIGNALS AND PAVEMENT MARKINGS .....	A-63
PLAN REVIEWS .....	A-63
PUBLIC INVOLVEMENT .....	A-63
RIGHT OF WAY .....	A-64
UTILITIES (UNDERGROUND AND OVERHEAD).....	A-64
TORT LIABILITY AND GEOMETRIC DESIGN .....	A-64
BACKGROUND ON TORT LIABILITY .....	A-65
RRR IMPROVEMENTS AND TORT CLAIMS.....	A-65
SUSCEPTIBILITY OF RRR PROJECTS AND STANDARDS TO TORT CLAIMS.....	A-65
DEFENSE OF A RRR PROJECT DESIGN.....	A-66
RRR NOTES ON PROJECT TITLE SHEET .....	A-67

**SECTION A-5-BICYCLE FACILITY GUIDELINES**

	<b>Page</b>
INTRODUCTION .....	A-68
VDOT POLICY TO IMPROVE BICYCLE & PEDESTRIAN ACCESS ...	A-69
BICYCLE ACCESS FACILITIES .....	A-70
EXISTING ROADS .....	A-71
MAJOR DEVELOPMENTS AND SITE PLANS.....	A-71
SELECTING ROADWAY DESIGN TREATMENTS TO ACCOMMODATE BICYCLES .....	A-72
VDOT/AASHTO DESIGN GUIDELINES .....	A-80
SHARED ROADWAYS .....	A-81
SIGNED SHARED ROADWAYS .....	A-83
BIKE LANES .....	A-83
SHARED USE PATHS.....	A-86
AASHTO APPROVED INTERSTATE BICYCLE ROUTES .....	A-95
RESOURCES .....	A-95

**SECTION A-6 AIRPORT CLEARANCE REQUIREMENTS**

	<b>Page</b>
ASSOCIATED CITY AIRPORT .....	A-100
ASSOCIATED CITY AIRPORT .....	A-101

**SECTION A-7-"NO PLAN" AND "MINIMUM PLAN" PROJECTS**

	<b>Page</b>
GENERAL CONCEPTS .....	A-102
PUBLIC HEARING AND RIGHT OF WAY .....	A-102
SPECIAL DESIGN STRUCTURES, SOIL SURVEY AND PAVEMENT DESIGN .....	A-103
MOBILIZATION AND FIELD OFFICE .....	A-103
EROSION AND SEDIMENT CONTROL .....	A-104
CONTRACT TIME LIMIT .....	A-104
PROCEDURES.....	A-104
PROJECT SCOPING & INITIAL FIELD REVIEW .....	A-105
"NO PLAN" PROJECTS.....	A-105
"MINIMUM PLAN" PROJECTS.....	A-107

PERMITS AND REVIEWS ("NO PLAN" AND "MINIMUM PLAN" PROJECTS)	A-108
PLAN PREPARATION	A-109
SPECIFICATIONS	A-109
PROJECT LAYOUT	A-110
INSPECTION AND RECORD KEEPING	A-111

**SECTION A-8-SEQUENCE OF CONSTRUCTION/MAINTENANCE OF TRAFFIC**

	<b>Page</b>
INTRODUCTION	A-112
SEQUENCE OF CONSTRUCTION	A-115
ITEMS TO ADDRESS UNDER SEQUENCE OF CONSTRUCTION	A-116
MAINTENANCE OF TRAFFIC	A-118
ITEMS TO BE ADDRESSED UNDER MAINTENANCE OF TRAFFIC INCLUDE:	A-121
NOTES WHICH MAY BE APPROPRIATE ON MAINTENANCE OF TRAFFIC AND SEQUENCE OF CONSTRUCTION PLANS INCLUDE	A-127
CONSTRUCTABILITY	A-128
ITEMS TO BE ADDRESSED UNDER CONSTRUCTABILITY INCLUDE	A-129
REFERENCES	A-130
INSTRUCTIONAL AND INFORMATIONAL MEMORANDA	A-131
SEQUENCE OF CONSTRUCTION AND MAINTENANCE OF TRAFFIC ITEMS TO CONSIDER	A-131

**LIST OF FIGURES**

	<b>Page</b>
TABLE A-1-1 DESIGN SPEEDS FOR VARIOUS FUNCTIONAL CLASSIFICATIONS	A-4
FIGURE A-1-1 GEOMETRIC DESIGN STANDARDS FOR RURAL PRINCIPAL ARTERIAL SYSTEM (GS-1)	A-5
FIGURE A-1-2 GEOMETRIC DESIGN STANDARDS FOR RURAL MINOR ARTERIAL SYSTEM (GS-2)	A-6
FIGURE A-1-3 GEOMETRIC DESIGN STANDARDS FOR RURAL LOCAL COLLECTOR SYSTEM (GS-3)	A-7
FIGURE A-1-4 GEOMETRIC DESIGN STANDARDS FOR RURAL LOCAL ROAD SYSTEM (GS-4)	A-8
FIGURE A-1-5 GEOMETRIC DESIGN STANDARDS FOR URBAN PRINCIPAL ARTERIAL SYSTEM (GS-5)	A-9
FIGURE A-1-6 GEOMETRIC DESIGN STANDARDS FOR URBAN MINOR ARTERIAL STREET SYSTEM (GS-6)	A-10
FIGURE A-1-7 GEOMETRIC DESIGN STANDARDS FOR URBAN COLLECTOR STREET SYSTEM (GS-7)	A-11
FIGURE A-1-8 GEOMETRIC DESIGN STANDARDS FOR URBAN LOCAL STREET SYSTEM (GS-8)	A-12
FIGURE A-1-9 GEOMETRIC STANDARDS FOR SERVICE ROADS (GS-9)	A-13
FIGURE A-1-10 GEOMETRIC DESIGN STANDARDS FOR INTERCHANGE RAMP (GS-RM)	A-14
FIGURE A-2-1 URBAN CLEAR ZONE WIDTH GUIDELINES	A-17
FIGURE A-2-2 COST EFFECTIVE SELECTION PROCEDURE	A-18
TABLE A-2-2 HORIZONTAL CURVE ADJUSTMENTS FOR CLEAR ZONE WIDTHS	A-23

FIGURE A-2-4 EXAMPLE OF A PARALLEL EMBANKMENT SLOPE DESIGN .....	A-24
TABLE A-3-1 DETERMINING WARRANTS FOR ROADWAY BARRIERS.....	A-28
TABLE A-3-2 TYPICAL BARRIER/GUARDRAIL SELECTION AND PLACEMENT .....	A-30
FIGURE A-3-1 BARRIER LENGTH OF NEED DETERMINATION .....	A-32
TABLE A-3-1 DESIGN PARAMETERS FOR ROADSIDE BARRIER LAYOUT.....	A-33
FIGURE A-3-2 SUGGESTED SLOPES FOR APPROACH BARRIERS.....	A-33
FIGURE A-3-3 DIMENSIONS FOR CRADH CUSHION.....	A-40
MINIMUM BRIDGE WIDTHS ON RRR PROJECTS .....	A-48
TABLE A-4-1 GEOMETRIC DESIGN CRITERIA .....	A-54
TABLE A-5-1 GROUP A BICYCLISTS, URBAN SECTION, NO PARKING .....	A-75
TABLE A-5-2 GROUP A BICYCLISTS, URBAN SECTION, WITH PARKING .....	A-76
TABLE A-5-3 GROUP A BICYCLISTS, RURAL SECTION.....	A-77
TABLE A-5-4 GROUP B/C BICYCLISTS, URBAN SECTION, NO PARKING.....	A-78
TABLE A-5-5 GROUP B/C BICYCLISTS, URBAN SECTION, WITH PARKING .....	A-79
TABLE A-5-6 GROUP B/C BICYCLISTS, RURAL SECTION .....	A-80
FIGURE A-5-1 PARKING PERMITTED WITH PARKING STRIPE .....	A-82
FIGURE A-5-2 TYPICAL BIKE LANE CROSS SECTIONS.....	A-84
FIGURE A-5-3 RIGHT TURN ONLY LANE .....	A-85
FIGURE A-5-4 CROSS SECTION OF TWO-WAY SHARED USE PATH ON SEPARATED RIGHT OF WAY .....	A-87
TABLE A-5-7 DESIRABLE MINIMUM RADII FOR PAVED SHARED USE PATHS BASED ON 15° LEAN ANGLE .....	A-88
TABLE A-5-8 MAXIMUM GRADE LENGTHS .....	A-89
TABLE A-5-9 MIN. STOPPING SIGHT DISTANCE (FT.) DESCENDING GRADE .....	A-90
TABLE A-5-10 MINIMUM STOPPING SIGHT DISTANCE (FT.) ASCENDING GRADE .....	A-90
TABLE A-5-11 MINIMUM LENGTH OF CREST VERTICAL CURVE (L) BASED ON STOPPING SIGHT DISTANCE.....	A-91
FIGURE A-5-5 MIN. LATERAL CLEARANCE (M) FOR HORIZONTAL CURVES .....	A-92
TABLE A-5-12 MIN. LATERAL CLEARANCE (M) FOR HORIZONTAL CURVES .....	A-92
FIGURE A-5-6 INTERSTATE BICYCLE ROUTE 1 AND 76.....	A-96
TABLE A-5-13 CONVERSION FACTORS FROM IMPERIAL TO METRIC .....	A-97

## APPENDIX A

### **SECTION A-1-GEOMETRIC DESIGN STANDARDS**

#### **INTRODUCTION**

VDOT (L&D) has formally adopted the AASHTO A Policy on Geometric Design of Highways and Streets, commonly referred to as the AASHTO "Green Book", as our minimum design standards. Therefore, **all** design criteria must meet AASHTO minimum standards.

Highway improvement plans are based on established **AASHTO** geometric design standards for various elements of the roadway under design. The tables on the following pages provide the **minimum** geometric standards, which are to be used for development of VDOT projects except those projects which can be developed using the Guidelines for RRR Projects located in Appendix A, Section A-4 of this manual. Note that there are no specific RRR standards for Interstate projects. If the designer has determined that Guidelines for RRR Projects do not apply to the project in question, the Geometric Design Standard tables on pages A-4 to A-13 should be used for project development.

The Geometric Standard Tables were developed using A Policy on Geometric Design of Highways and Streets published by the American Association of State Highway and Transportation Officials (AASHTO). These tables present basic practical guidelines compatible with traffic, topography and safety; however, due to the restrictive format, all variables could not be included. The designer is urged to refer to the above named publication and other related chapters in the Road Design Manual for further discussion of design considerations before selecting the proper design speed criteria for a given project.

**THE APPLICATION OF THE CRITERIA PROVIDED IN THE GEOMETRIC DESIGN STANDARD TABLES MUST BE MADE IN RELATION TO THEIR EFFECT ON THE ROADWAY SYSTEM AND IN CONJUNCTION WITH SOUND ENGINEERING JUDGMENT TO ENSURE AN APPROPRIATE DESIGN.** The economic, environmental and social factors involved in highway design shall also be considered. The designer should always attempt to provide for the highest degree of safety and best level of service that is economically feasible. The "minimum" design criteria shown in the tables should only be used when overriding economic or environmental considerations so dictate.

#### **ROADWAY WIDTH**

Roadway width as referenced in this section is the portion of the highway, including graded shoulders, for vehicular use.

#### **DESIGN SPEED**

Design speed is defined as a speed determined for design and correlation of the physical features of a highway that influence vehicle operation - the maximum safe speed maintainable over a specified section of highway when conditions permit design features to govern.

The geometric tables indicate a design speed range for each functional classification. The selection of the proper design speed to be used on a particular project is of primary importance in project development. The design speed selected should:

- be logical with respect to topography, anticipated operating speed, adjacent land use, and functional classification of the highway.
- be as high as practicable to attain a desired degree of safety, mobility and efficiency while under the constraints of environmental quality, economics, aesthetics and social or political impacts.
- be consistent with the speed a driver is likely to expect. Drivers do not adjust their speeds to the importance of the highway, but to their perception of the physical limitations and traffic.

Although the design speeds for rural highways are coupled with a terrain classification, terrain is only one of the several factors involved in determining the appropriate design speed of a highway.

Although the selected design speed establishes the maximum degree of curvature and minimum sight distance necessary for safe operation, there should be no restriction on the use of flatter horizontal curves or greater sight distances where such improvements can be provided as a part of economic design. However, if a succession of flatter curves or tangent sections would encourage drivers to operate at higher speeds, that section of highway should be designed for a higher speed and all geometric features, particularly that of sight distance on crest vertical curves and intersection sight distance should be related to it.

Table A-1-1 indicates the various speed ranges applicable to each functional classification.

## **EXCEPTIONS**

Where it is impractical or not economical to obtain the AASHTO minimum design criteria as shown in the Geometric Design Tables, an exception shall be secured from the State Location and Design Engineer and FHWA (if applicable). For additional instructions on Design Exceptions, see Instructional and Informational Memorandum IIM-LD-227.

**THIS SHEET IS LEFT INTENTIONALLY BLANK**



DESIGN SPEEDS FOR VARIOUS FUNCTIONAL CLASSIFICATIONS							
L=Min. for Level Terrain R=Min. for Rolling Terrain M=Min. for Mountainous Terrain (As defined by Section 23 of the Highway Capacity Manual) CBD=Min. for Central Business District S=Min. for Suburban Area D=Min. for Developing Area		SPEED (MPH)					
		20	30	40	50	60	70
ROADWAY CLASSIFICATION		20	30	40	50	60	70
RURAL ARTERIAL	Freeways – 70 MPH MIN. 60 MPH – R MIN. 50 MPH – M			X M	X R	X L	X
RURAL COLLECTOR ROAD	ADT OVER 2000			X M	X R	X L	
	CURRENT ADT 400 TO 2000		X M	X R	X L		
	CURRENT ADT UNDER 400	X M	X R	X L			
RURAL LOCAL ROAD	CURRENT ADT OVER 400		X M	X R	X L		
	CURRENT ADT 400 OR UNDER	X M	X R	X L			
URBAN ARTERIAL	<u>FREEWAYS</u> MIN. 50 MPH		X CBD	X S	X	X D	X
URBAN COLLECTOR STREET			X	X	X		
URBAN LOCAL STREET		X	X				

**TABLE A-1-1**

### GEOMETRIC DESIGN STANDARDS FOR RURAL PRINCIPAL ARTERIAL SYSTEM (GS-1)

	TERRAIN	DESIGN SPEED (MPH)	MINIMUM RADIUS	(6) STOPPING SIGHT DISTANCE	MIN. WIDTH OF LANE	(1) MINIMUM WIDTH OF TOTAL SHOULDERS (Graded + Paved)		(2) PAVED SHOULDER WIDTH		(3) WIDTH OF DITCH (FRONT SLOPE)	(4) SLOPE	(5) NEW AND RECONSTRUCTED MINIMUM BRIDGE WIDTHS AND VERTICAL CLEARANCES
						FILL	CUT	RT.	LT.			
				Min.								
FREEWAYS	LEVEL	70	1821'	730'	12'	17'	14'	12'	4'	12'	CS-4B	2 THRU LANES SAME DIRECTION = 6' + PAVE. WIDTH + 14' 3 OR MORE THRU LANES SAME DIRECTION = 14' + PAVE. WIDTH + 14'
	ROLLING	60	1204'	570'								
	MOUNTAINOUS	50	760'	425'								
OTHER PRINCIPAL ARTERIALS	LEVEL	70	1821'	730'	12'	13'	10'	8'	4'	10'	CS-4 OR 4B	UNDIVIDED & DIVIDED 3 OR MORE THRU LANES SAME DIRECTION = 10' + PAVE. WIDTH + 10'
		60	1204'	570'						6'		
	ROLLING	60	1204'	570'							CS-4 OR 4E	
		50	760'	425'								
	MOUNTAINOUS	50	760'	425'							CS-3 OR 3B	
		40	465'	305'								

### GENERAL NOTES

**Freeways** - A design speed of 70 mph should be used for Rural Freeways. Where terrain is mountainous a design speed of 60 mph or 50 mph, which is consistent with driver expectancy, may be used. All new and major reconstructed Interstate facilities will have a 70 mph design speed unless a lower design speed is approved by the Location and Design Engineer and FHWA.

**Other Principal Arterials** - A design speed of 40 to 70 mph should be used depending on terrain, driver expectancy and whether the design is constructed on new location or reconstruction of an existing facility. An important safety consideration in the selection of one of the lower design speeds in each range is to have a properly posted speed limit which is enforced during off peak hours.

Incorporated towns or other built-up areas, Urban Standard GS-5 may be used for design.

Standard TC-5.01R superelevation based on 8% maximum is to be used for all Rural Principal Arterials.

Clear Zone and Recoverable Area information can be found in Appendix A, Section A-2 of the Road Design Manual.

If medians are included, see Section 2E-3 of Chapter 2E of the Road Design Manual.

### FOOTNOTES

- Shoulder widths shown are for right shoulders and independently graded median shoulders. On non-Interstate, an 8' graded median shoulder will be provided when the mainline is 4 lanes (both directions). For 6 or more lanes, the median shoulder provided will be the same as that shown for independent grading. On Freeways, if truck is less than 250 DDHV, the minimum width of total shoulder shall be 15' for fills and 12' for cuts.
- When the mainline is 6 or more lanes, the left paved shoulder width should be the same as the right paved shoulder. On Freeways, if truck traffic is less than 250 DDHV, the minimum right paved shoulder width shall be 10'.
- Ditch slopes to be 6:1 - 10' and 12' widths and 4:1 - 6' width.
- Additional or modified slope criteria to apply where shown on typical sections.
- Vertical clearance at roadway underpasses for new and reconstructed bridges is to be 16'-6" (1' additional clearance required for non-vehicular overpasses). Right Shoulder may be 10' minimum when truck traffic is less than 250 DDHV.
- For intersection sight distance requirements see Appendix C, Table C-1-5.

RELATIONSHIP OF MAXIMUM GRADES TO DESIGN SPEEDS							
TYPE OF TERRAIN	FREEWAYS			ARTERIALS			
	DESIGN SPEED (MPH)						
	50	60	70	40	50	60	70
	GRADES (PERCENT) *						
LEVEL	4	3	3	5	4	3	3
ROLLING	5	4	4	6	5	4	4
MOUNTAINOUS	6	6	5	8	7	6	5

FIGURE A - 1 - 1

## GEOMETRIC DESIGN STANDARDS FOR RURAL MINOR ARTERIAL SYSTEM (GS-2)

TRAFFIC VOLUME	TERRAIN	DESIGN SPEED (MPH)	MIN. RADIUS	(8)	MINIMUM PASSING SIGHT DISTANCE	(2) MIN. WIDTH OF LANE	(3) MIN. WIDTH OF GRADED SHOULDERS		(4) PAVED SHOULDER WIDTH		(5) WIDTH OF DITCH (FRONT SLOPE)	(6) SLOPE	(7) NEW AND RECONSTRUCTED MINIMUM BRIDGE WIDTHS AND VERTICAL CLEARANCES
				STOPPING SIGHT DISTANCE			FILL W/GR	CUT & FILL	RT	LT			
				Min.									
(1) ADT OVER 2000	LEVEL	70	1821'	730'	2500'	12'	13'	10'	8'	4'	10'	CS-4, CS-4A OR CS-4C	10' PLUS PAVEMENT WIDTH PLUS 10'
		60	1204'	570'	2150'								
	ROLLING	60	1204'	570'	2150'								
		50	760'	425'	1850'								
	MOUNTAINOUS	50	760'	425'	1850'								
		40	465'	305'	1500'								
(1) ADT 1500 TO 2000	LEVEL	70	1821'	730'	2500'	12'	11'	8'	6'	4'	6'	CS-4, CS-4A OR CS-4C	8' PLUS PAVEMENT WIDTH PLUS 8'
		60	1204'	570'	2150'								
	ROLLING	60	1204'	570'	2150'								
		50	760'	425'	1850'								
	MOUNTAINOUS	50	760'	425'	1850'								
		40	465'	305'	1500'								
ADT 400 TO 1500	LEVEL	70	1821'	730'	2500'	12'	11'	8'	6'	4'	6'	CS-4, CS-4A OR CS-4C	8' PLUS PAVEMENT WIDTH PLUS 8'
		60	1204'	570'	2150'								
	ROLLING	60	1204'	570'	2150'								
		50	760'	425'	1850'								
	MOUNTAINOUS	50	760'	425'	1850'								
		40	465'	305'	1500'								
ADT UNDER 400	LEVEL	70	1821'	730'	2500'	12'	9'	6'	4'	4'	6'	CS-4, CS-4A OR CS-4C	6' PLUS PAVEMENT WIDTH PLUS 6'
		60	1204'	570'	2150'								
	ROLLING	60	1204'	570'	2150'								
		50	760'	425'	1850'								
	MOUNTAINOUS	50	760'	425'	1850'								
		40	465'	305'	1500'								

### GENERAL NOTES

Rural Minor Arterials are designed with design speeds of 50 to 70 MPH, dependent on terrain features and traffic volumes, and occasionally may be as low as 40 MPH in mountainous terrain.

In incorporated towns or other built-up areas, Urban Standard GS-6 may be used for design.

Standard TC-5.01R superelevation based on 8% maximum is to be used for Rural Minor Collectors. If medians are included, see [Section 2E](#) of the [Road Design Manual](#).

Clear zone and Recoverable Area information can be found in

RELATIONSHIP OF MAXIMUM GRADES TO DESIGN SPEEDS				
TYPE OF TERRAIN	DESIGN SPEED (MPH)			
	40	50	60	70
	GRADES (PERCENT)			
LEVEL	5	4	3	3
ROLLING	6	5	4	4
MOUNTAINOUS	8	7	6	5

Appendix A, Section A-2 of the [Road Design Manual](#).

### FOOTNOTES

- (1) Use current ADT for restoration type projects (not applicable to RRR projects) and use design year ADT for all other projects.
- (2) Lane width to be 12' at all interchange locations. For projects not on the National Highway System, width of traveled way may remain at 22' on reconstructed highways where alignment and safety records are satisfactory.
- (3) If graded median is used, the width of median shoulder is to be 8'.
- (4) The Paved widths shown are the widths to be used if the Materials Division recommends the shoulders be paved. When the mainline is 4 lanes (both directions) a minimum 8' wide paved shoulder will be provided on the right of traffic and a minimum 4' wide paved shoulder on the median side. Where the mainline is 6 or more lanes, both right and median paved shoulders will be 8' in width. If paved shoulders are not recommended by the Materials Division the mainline pavement structure will be extended 1' at the same slope into the shoulder to eliminate raveling of the pavement edge.
- (5) Ditch slopes to be 6:1 - 10' width, 4:1 - 6' width.
- (6) Additional or modified slope criteria to be applied where shown on typical sections.
- (7) Vertical clearance at roadway underpasses for new and reconstructed bridges is to be 16'-6" (1' additional clearance required for non-vehicular overpasses).
- (8) For intersection sight distance requirements see [Appendix C, Table C-1-5](#).

**FIGURE A-1-2**

**GEOMETRIC DESIGN STANDARDS FOR RURAL COLLECTOR ROAD SYSTEM (GS-3)**

TRAFFIC VOLUME	TERRAIN	DESIGN SPEED (MPH)	MINIMUM RADIUS	(9)	MINIMUM PASSING SIGHT DISTANCE	(2) MIN. WIDTH OF LANE	(3)(4) MIN. WIDTH OF GRADED SHOULDERS		(5) WIDTH OF DITCH (FRONT SLOPE)	(6) RECOMMENDED SLOPE	(7)(8) NEW AND RECONSTRUCTED MINIMUM BRIDGE WIDTHS AND VERTICAL CLEARANCES
				STOPPING SIGHT DISTANCE			FILL W/GR	CUT & FILL			
(1) ADT OVER 2000	LEVEL	60	1204'	570'	2150'	12'	11'	8'	10'	CS-4, CS-4A OR CS-4C	APPROACH ROADWAY WIDTH
	ROLLING	50	760'	425'	1850'				6'		
	MOUNTAINOUS	40	465'	305'	1500'				CS-3 OR CS-3B		
(1) ADT 1500 TO 2000	LEVEL	50	760'	425'	1850'	11'	9'	6'	6'	CS-4, CS-4A OR CS-4C	4' PLUS PAVEMENT WIDTH PLUS 4'
	ROLLING	40	465'	305'	1500'				4'		
	MOUNTAINOUS	30	251'	200'	1100'				CS-3 OR CS-3B		
CURRENT ADT 400 TO 1500	LEVEL	50	760'	425'	1850'	11'	7'	5'	6'	CS-4, CS-4A OR CS-4C	3' PLUS PAVEMENT WIDTH PLUS 3'
	ROLLING	40	465'	305'	1500'				4'		
	MOUNTAINOUS	30	251'	200'	1100'				CS-3 OR CS-3B		
CURRENT ADT UNDER 400	LEVEL	40	465'	305'	1500'	10'	7'	2'	6'	CS-1	2' PLUS PAVEMENT WIDTH PLUS 2'
	ROLLING	30	251'	200'	1100'				4'		
	MOUNTAINOUS	20	108'	125'	800'						

**GENERAL NOTES**

Geometric design features should be consistent with a design speed appropriate for the conditions.

Low design speeds (40 MPH and below) are generally applicable to highways with curvilinear alignment in rolling or mountainous terrain and where environmental conditions dictate.

High design speeds (45 MPH and above) are generally applicable to highways in level terrain or where other environmental conditions are favorable.

Intermediate design speeds would be appropriate where terrain and other environmental conditions are a combination of those described for low and high design speed.

The designer should strive for higher values than the minimum where conditions of safety dictate and costs can be supported.

In incorporated towns or other built-up areas, Urban Standard GS-7 may be used.

Standard TC-5.01R superelevation based on 8% maximum is to be used for Rural Collectors.

RELATIONSHIP OF MAXIMUM GRADES TO DESIGN SPEEDS					
TYPE OF TERRAIN	DESIGN SPEED (MPH)				
	20	30	40	50	60
	GRADES (PERCENT)				
LEVEL	7	7	7	6	5
ROLLING	10	9	8	7	6
MOUNTAINOUS	12	10	10	9	8

Maximum grades of short length (less than 500'), on one-way downgrades and on low-volume Rural Collectors may be 2 percent steeper.

Clear zone and Recoverable Area information can be found in Appendix A, Section A-2 of the Road Design Manual.

**FOOTNOTES**

- Use current ADT for restoration type projects (not applicable to RRR projects) and use design year ADT for new construction.
- Lane width to be 12' at all interchange locations.
- Provide 4' wide paved shoulders when design year ADT exceeds 2000 VPD, with 5% or more truck and bus usage. All shoulders not being paved will have the mainline pavement structure extended 1' on the same slope into the shoulder to eliminate raveling at the pavement edge.
- When the mainline is four lanes, a minimum paved shoulder width of 6' right of traffic and 3' left of traffic will be provided.
- Ditch slopes to be 6:1 - 10' width, 4:1 - 6' width, 3:1 - 4' width.
- Additional or modified slope criteria to be applied where shown on typical sections.
- Where the approach roadway width (traveled way plus shoulder) is surfaced, that surfaced width shall be carried across all structures if that width exceeds the width shown in this table.
- Vertical clearance at roadway underpasses for new and reconstructed bridges is to be 16'-6" desirable and 14'-6" minimum (1' additional clearance required for non-vehicular overpasses).
- For intersection sight distance requirements see [Appendix C, Table C-1-5](#).

**FIGURE A - 1 - 3**

## GEOMETRIC DESIGN STANDARDS FOR RURAL LOCAL ROAD SYSTEM (GS-4)

TRAFFIC VOLUME	TERRAIN	DESIGN SPEED (MPH)	MINIMUM RADIUS	(9)	MINIMUM PASSING SIGHT DISTANCE	(2)	(3)(4)(5)		(6)	(7)	(8)
				STOPPING SIGHT DISTANCE			MIN. WIDTH OF GRADED SHOULDERS	FILL W/GR			
				Min.							
(1) ADT OVER 2000	LEVEL	50	760'	425'	1850'	24'	11'	8'	6"	CS-4, 4A OR 4C	APPROACH ROADWAY WIDTH
	ROLLING	40	465'	305'	1500'				8'		
	MOUNTAINOUS	30	251'	200'	1100'				4'		
(1) ADT 1500 TO 2000	LEVEL	50	760'	425'	1850'	22'	9'	6'	6'	CS-4, 4A OR 4C	3' PLUS PAVEMENT WIDTH PLUS 3'
	ROLLING	40	465'	305'	1500'				6'		
	MOUNTAINOUS	30	251'	200'	1100'				4'		
ADT 400 TO 1500	LEVEL	50	760'	425'	1500'	20'	7'	5'	6'	CS-1	2' PLUS PAVEMENT WIDTH PLUS 2'
	ROLLING	40	465'	305'	1100'				4'		
	MOUNTAINOUS	30	251'	200'	800'						
CURRENT ADT UNDER 400	LEVEL	40	465'	305'	1100'	18'	7'	2'	4'	CS-1	
	ROLLING	30	251'	200'	800'						
	MOUNTAINOUS	20	108'	125'							

### GENERAL NOTES

Low design speeds are generally applicable to roads with winding alignment in rolling or mountainous terrain where environmental conditions dictate.

High design speeds are generally applicable to roads in level terrain or where other environmental conditions are favorable.

Intermediate design speeds would be appropriate where terrain and other environmental conditions are a combination of those described for low and high speed.

Standard TC-5.01R superelevation based on 8% maximum is to be used.

In incorporated towns or other built-up areas, Urban Standard GS-8 may be used.

### FOOTNOTES

- (1) Use current ADT for restoration type projects (not applicable to RRR projects) and use design year ADT for new construction.
- (2) Lane width to be 12' at all interchange locations.
- (3) In mountainous terrain or sections with heavy earthwork, the graded width of shoulder in cuts may be decreased 2', but in no case shall the shoulder width be less than 2'.
- (4) Minimum shoulder slope shall be 1":1' on low side and same slope as pavement on high side.
- (5) Provide 4' wide paved shoulders when design year ADT exceeds 2000 VPD, with 5% or more truck and bus usage. All shoulders not being paved will have the mainline pavement structure extended 1' on the same slope into the shoulder to eliminate raveling at the pavement edge.
- (6) Ditch slopes to be 4:1 - 6' width, 3:1 - 4' width.
- (7) Additional or modified slope criteria to be applied where shown on typical sections.
- (8) Vertical clearance at roadway underpasses for new and reconstructed bridges is 16'-6" desirable and 14'-6" minimum (1' additional clearance required for non-vehicular overpasses).
- (9) For intersection sight distance requirements see [Appendix C, Table C-1-5](#).

RELATIONSHIP OF MAXIMUM GRADES TO DESIGN SPEEDS					
TYPE OF TERRAIN	DESIGN SPEED (MPH)				
	20	30	40	50	60
GRADES (PERCENT)					
LEVEL	8	7	7	6	5
ROLLING	11	10	10	8	6
MOUNTAINOUS	16	14	13	10	--

**FIGURE A - 1 - 4**

### GEOMETRIC DESIGN STANDARDS FOR URBAN PRINCIPAL ARTERIAL SYSTEM (GS-5)

	DESIGN SPEED (MPH)	MINIMUM RADIUS		(13) STOPPING SIGHT DISTANCE	MIN. WIDTH OF LANE	(1) MINIMUM WIDTH GRADED SHOULDERS		(2) PAVED SHOULDER WIDTH		(3) WIDTH OF DITCH (FRONT SLOPE)	(4) SLOPE	(7) NEW AND RECONSTRUCTED MINIMUM BRIDGE WIDTHS AND VERTICAL CLEARANCES
		U	ULS	Min.		FILL W/GR	CUT & FILL	RT.	LT.			
FREEWAYS	70	1821'	-	730'	12'	15'	12'	10'	4'	12'	CS-4 OR CS-4B	2 THRU LANES SAME DIRECTION = 6' + PAVE. WIDTH + 12' 3 OR MORE THRU LANES SAME DIRECTION = 12' + PAVE. WIDTH + 12'
	60	1204'	-	570'								
	50	760'	-	425'								
OTHER PRINCIPAL ARTERIAL WITH SHOULDER DESIGN	60	1204'	-	570'	(12) 12'	13'	10'	8'	4'	10'	CS-4 OR CS-4E	UNDIVIDED & DIVIDED 3 OR MORE THRU LANES SAME DIRECTION = 10' + PAVE. WIDTH + 10'
	50	929'	-	425'								
	40	563'	593'	305'	(5)(6) (12) 11'	6'	CS-3 OR CS-3B	2 THRU LANES (DIVIDED) SAME DIRECTION 6' + PAVE. WIDTH + 10'				
	30	300'	273'	200'								
	DESIGN SPEED (MPH)	MINIMUM RADIUS		STOPPING SIGHT DISTANCE	MIN. WIDTH OF LANE	(8) STANDARD CURB & GUTTER	BUFFER STRIP WIDTH	(9) MINIMUM SIDEWALK WIDTH	(10) SLOPE	(7) NEW AND RECONSTRUCTED MINIMUM BRIDGE WIDTHS AND VERTICAL CLEARANCES		
		U	ULS	MIN.								
OTHER PRINCIPAL ARTERIAL WITH CURB & GUTTER	60	1204'	-	570'	(12) 12'	CG-7	(11)	5'	2:1	SAME AS CURB TO CURB OF APPROACHES		
	50	929'	-	425'								
	45	732'	795'	360'								
	40	563'	593'	305'	(5)(6) (12) 11'	CG-6						
	30	300'	273'	200'								

### GENERAL NOTES

**Freeways** - Urban Freeways should accommodate desired safe operating speeds during non-peak hours, but should not be so high as to exceed the limits of prudent construction, right of way and socioeconomic costs due to the large proportion of vehicles which are accommodated during periods of peak flow when lower speeds are necessary. The design speeds for Freeways should never be less than 50 mph.

On many Urban Freeways, particularly in suburban areas, a design speed of 60 mph or higher can be provided with little additional cost above that required for 50 mph design speed. The corridor of the mainline may be relatively straight and the character and location of interchanges may permit high speed design. Under these conditions, a design speed of 70 mph is most desirable because the higher design speeds are closely related to the overall quality and safety of the facility.

**Other Principal Arterials** - Design speeds for Urban Arterials generally range from 40 to 60 mph, and occasionally may be as low as 30 mph. The lower (40 mph and below) speeds apply in the central business district and intermediate areas. The higher speeds are more applicable to the outlying business and developing areas.

Standard TC-5.01R superelevation based on 8% maximum is to be used for all Freeways and other Principal Arterials with a design speed greater than or equal to 60 mph.

Standard TC-5.01U (Urban) superelevation based on 4% maximum is to be used on Other Principal Arterials with a design speed less than 60 mph.

RELATIONSHIP OF MAXIMUM GRADES TO DESIGN SPEEDS									
TYPE OF TERRAIN	FREEWAYS *					ARTERIALS			
	DESIGN SPEED (MPH)								
	50	60	70	30	40	45	50	60	
	GRADES (PERCENT)								
LEVEL	4	3	3	8	7	6	6	5	
ROLLING	5	4	4	9	8	7	7	6	
MOUNTAINOUS	6	6	5	11	10	9	9	8	

\* Grades 1 percent steeper than the value shown may be used on Urban Freeways for extreme cases in urban areas where development precludes the use of flatter grades and for one-way downgrades, except in mountainous terrain.

Standard TC-5.04ULS (Urban Low Speed) superelevation based on 2% maximum is to be used on Other Principal Arterials with a design speed less than or equal to 45 mph (45 mph = 7% maximum).

Clear Zone and Recoverable Area information can be found in Appendix A, Section A-2 of the Road Design Manual.

If medians are included, see Section 2E-3 of Chapter 2E of the Road Design Manual.

A minimum 30' width of surfacing or a minimum 30' face to face of curb is to be used within incorporated cities or towns to qualify for maintenance payments.

For guidelines on Interchange Ramp, see Standard GS-R.

### FOOTNOTES

- Shoulder widths shown are for right shoulders and independently graded median shoulders. An 8' graded median shoulder will be provided when the mainline is 4 lanes (both directions). For 6 or more lanes, the median shoulder provided will be the same as that shown for independent grading. On Freeways, if truck traffic exceeds 250 DDHV, the minimum width of graded shoulder should be 17' for fills and 14' for cuts.
- When the mainline is 6 or more lanes, the left paved shoulder width should be the same as the right paved shoulder. On Freeways, if truck traffic exceeds 250 DDHV, the right paved shoulder width should be 12', and on 6 or more lane Freeways, the left paved shoulder width should also be 12' if truck traffic exceeds 250 DDHV.
- Ditch slopes to be 6:1 - 10' and 12' widths and 4:1 - 6' width.
- Additional or modified slope criteria to apply where shown on typical sections.
- Minimum lane width to be 12' at all interchange locations.
- If heavy truck traffic is anticipated, an additional 1 foot width is desirable.
- Vertical clearance at roadway underpasses for new and reconstructed bridges is to be 16'-6" (1' additional clearance required for non-vehicular overpasses).
- Or equivalent City or Town design.
- Width of 8' or more may be needed in commercial areas.
- 3:1 and flatter slopes may be used when the right of way is behind the sidewalk (or sidewalk space) in residential or other areas where slopes will be maintained by the property owner.
- If a buffer strip is used between the back of curb and sidewalk, it should be 2' minimum.
- Situations having restrictions on trucks may allow the use of lanes 1 foot less in width.
- For intersection sight distance requirements see Appendix C, Table C-1-5.

FIGURE A - 1 - 5

**GEOMETRIC DESIGN STANDARDS-URBAN MINOR ARTERIAL STREET SYSTEM (GS-6)**

	DESIGN SPEED (MPH)	MINIMUM RADIUS		(12) STOPPING SIGHT DISTANCE	(11) MIN. WIDTH OF LANE	(3) STANDARD CURB & GUTTER	BUFFER STRIP WIDTH	(4) MINIMUM SIDEWALK WIDTH	(5) SLOPE	(6) NEW AND RECONSTRUCTED MINIMUM BRIDGE WIDTHS AND VERTICAL CLEARANCES			
		U	ULS	Min.									
STREETS WITH CURB & GUTTER	60	1204'	-	570'	12'	CG-7	(10)	5'	2:1	SAME AS CURB TO CURB OF APPROACHES			
	50	929'	-	425'									
	45	732'	795'	360'									
	40	563'	593'	305'	(1)(2) 11'	CG-6							
	30	300'	273'	200'									
	DESIGN SPEED (MPH)	MINIMUM RADIUS		STOPPING SIGHT DISTANCE	MIN. WIDTH OF LANE	(7) MIN. WIDTH OF GRADED SHOULDERS		(8) PAVED SHOULDER WIDTH		(9) WIDTH OF DITCH (FRONT) SLOPE	(5) SLOPE	(6) NEW AND RECONSTRUCTED MINIMUM BRIDGE WIDTHS AND VERTICAL CLEARANCES	
		U	ULS	MIN.		FILL W/GR	CUT & FILL	RT	LT				
STREETS WITH SHOULDER DESIGN	60	1204'	-	570'	12'	13'	10'	8'	4'	10'	2:1	10' + PAVEMENT WIDTH + 10'	
	50	929'	-	425'		(1)(2) 11'	11'	8'	6'	4'		6'	8' + PAVEMENT WIDTH + 8'
	40	563'	593'	305'									
	30	300'	273'	200'									

**GENERAL NOTES**

Design Speeds for Urban Arterials generally range from 40 to 60 mph and occasionally may be as low as 30 mph. The lower (40 mph and below) speeds apply in the central business district and intermediate areas. The higher speeds are more applicable to the outlying business and developing areas.

Standard TC-5.01R superelevation based on 8% maximum is to be used for 60 mph design speed.

Standard TC-5.01U (Urban) superelevation based on 4% maximum is to be used for design speeds less than 60 mph.

Standard TC-5.04ULS (Urban Low Speed) superelevation based on 2% maximum may be used for design speeds less than or equal to 45 mph (45 mph = 7° maximum).

Clear Zone and Recoverable Area information can be found in Appendix A, Section A-2 of the Road Design Manual.

If medians are included, see [Section 2E-3 of Chapter 2E](#) of the Road Design Manual.

A minimum 30' width of surfacing or a minimum 30' face to face of curb is to be used within incorporated cities or towns to qualify for maintenance payments.

RELATIONSHIP OF MAXIMUM GRADES TO DESIGN SPEEDS					
TYPE OF TERRAIN	DESIGN SPEED (MPH)				
	30	40	45	50	60
	GRADES (PERCENT)				
LEVEL	8	7	6	6	5
ROLLING	9	8	7	7	6
MOUNTAINOUS	11	10	9	9	8

**FOOTNOTES**

- (1) Lane width to be 12' at all interchanges or if design year ADT exceeds 2000.
- (2) If heavy truck traffic is anticipated, an additional 1' width is desirable.
- (3) Or equivalent City or Town design.
- (4) A width of 8' or more may be needed in commercial areas.
- (5) Slopes 3:1 and flatter may be used when the right of way is behind the sidewalk (or sidewalk space) in residential or other areas where slopes will be maintained by the property owner.
- (6) Vertical clearance at roadway underpasses for new and reconstructed bridges is to be 16'-6" (1' additional clearance required for non-vehicular overpasses).
- (7) If graded median is used, the width of median shoulder is to be 8'.
- (8) The Paved widths shown are the widths to be used if the Materials Division recommends the shoulders be paved. When the mainline is 4 lanes (both directions) a minimum 8' wide paved shoulder will be provided on the right of traffic and a minimum 4' wide paved shoulder on the median side. Where the mainline is 6 or more lanes, both right and median paved shoulders will be 8' in width. If paved shoulders are not recommended by the Materials Division the mainline pavement structure will be extended 1' at the same slope into the shoulder to eliminate raveling of the pavement edge.
- (9) Ditch slope to be 6:1 - 10' width and 4:1 - 6' width.
- (10) If a buffer strip is used between the back of curb and sidewalk, it should be 2' minimum.
- (11) Situations having restrictions on trucks may allow the use of lanes 1' less in width.
- (12) For intersection sight distance requirements see [Appendix C, Table C-1-5](#).

**FIGURE A - 1 - 6**



# GEOMETRIC DESIGN STANDARDS FOR URBAN COLLECTOR STREET SYSTEM (GS-7) Rev. 7/05

	DESIGN SPEED (MPH)	MINIMUM RADIUS		(11) STOPPING SIGHT DISTANCE	(1) (2) MIN. WIDTH OF LANE	(3) STANDARD CURB & GUTTER	BUFFER STRIP WIDTH	(4) MINIMUM SIDEWALK WIDTH	(5) SLOPE	(8)(9) NEW AND RECONSTRUCTED MINIMUM BRIDGE WIDTHS AND VERTICAL CLEARANCES
		U	ULS	Min.						
STREETS WITH CURB & GUTTER	50	929'	-	425'	12'	CG-7	(10)	5'	2:1	SAME AS CURB TO CURB OF APPROACHES
	45	732'	795'	360'		CG-6				
	40	563'	593'	305'	(1)(2) 11'					
	30	300'	273'	200'						
	DESIGN SPEED (MPH)	MINIMUM RADIUS		STOPPING SIGHT DISTANCE	(1)(2) MIN. WIDTH OF LANE	(7) MINIMUM WIDTH GRADED SHOULDERS		(10) WIDTH OF DITCH (FRONT) SLOPE	(5) SLOPE	(8)(9) NEW AND RECONSTRUCTED MINIMUM BRIDGE WIDTHS AND VERTICAL CLEARANCES
		U	ULS	MIN.		FILL W/G.R.	CUT & FILL			
STREETS WITH SHOULDER DESIGN	50	929'	-	425'	12'	11'	8'	6'	2:1	8' + PAVEMENT WIDTH + 8'
	40	563'	593'	305'	(1)(2) 11'					7'
	30	300'	273'	200'						

### GENERAL NOTES

A minimum design speed of 30 mph or higher should be used for collector streets, depending on available right of way, terrain, adjacent development and other area controls.

In the typical street grid, the closely spaced intersections usually limit vehicular speeds and thus make the effect of design speed of less significance. Nevertheless, the longer sight distances and curve radii commensurate with design speeds higher than the value indicated result in safer highways and should be used to the extent practicable.

Standard TC-5.01U (Urban) superelevation based on 4% maximum.

Standard TC-5.04ULS (Urban-Low Speed) superelevation based on 2% maximum may be used with a design speed of 45 mph or less (45 MPH = 7% maximum).

A minimum 30' width of surfacing or a minimum 30' curb to curb is to be used within incorporated cities or towns to qualify for maintenance payments.

Clear zone and Recoverable Area information can be found in Appendix A, Section A-2 of the Road Design Manual.

### FOOTNOTES

- (1) 12' when ADT exceeds 2000'. Where feasible, lanes should be 12' wide in industrial areas; however, where available or attainable right of way imposes severe limitations, 10' lanes can be used in residential areas and 11' lanes can be used in industrial areas.
- (2) Lane width to be 12' at all interchange locations.
- (3) Or equivalent City or Town Design.
- (4) A width of 8' or more may be needed in commercial areas.
- (5) 3:1 and flatter slopes may be used when right of way is behind the sidewalk (or sidewalk space) in residential or other areas where the slopes will be maintained by the property owner.
- (6) Ditch slopes to be 4:1 - 6' width and 3:1 - 4' width.
- (7) When Design year ADT exceeds 2000 VPD, with greater than 5% total truck and bus usage: Provide 4' wide paved shoulders when the graded shoulder is 5' wide or greater or provide 3' wide paved shoulders when the graded shoulder is 4' wide. All shoulders not being paved will have the mainline pavement structure extended 1', on the same slope, into the shoulder to eliminate raveling at the pavement edge.
- (8) Where the approach roadway width (traveled way plus shoulder) is surfaced, that surfaced width shall be carried across all structures if that width exceeds the width shown in this table.
- (9) Vertical clearance at roadway underpasses for new and reconstructed bridges is to be 16'-6" desirable and 14'-6" minimum (1' additional clearance required for non-vehicular overpasses).
- (10) If a buffer strip is used between the back of curb and sidewalk, it should be 2' minimum.
- (11) For intersection sight distance requirements see [Appendix C, Table C-1-5](#).

RELATIONSHIP OF MAXIMUM GRADES TO DESIGN SPEEDS				
TYPE OF TERRAIN	DESIGN SPEED (MPH)			
	30	40	45	50
	GRADES (PERCENT)			
LEVEL	9	9	8	7
ROLLING	11	10	9	8
MOUNTAINOUS	12	12	11	10

Maximum grades of short lengths (less than 500 ft.) and one-way down grades may be 2% steeper.

**FIGURE A - 1 - 7**



**GEOMETRIC DESIGN STANDARDS FOR URBAN LOCAL STREET SYSTEM (GS-8)**

	DESIGN SPEED (MPH)	MINIMUM RADIUS		(1) MAXIMUM PERCENT OF GRADE	(11) STOPPING SIGHT DISTANCE	(2) MIN. WIDTH OF LANE	(3) STANDARD CURB & GUTTER	(4) BUFFER STRIP WIDTH	(5) MINIMUM SIDEWALK WIDTH	(6) SLOPES	(9) (10) NEW AND RECONSTRUCTED MINIMUM BRIDGE WIDTHS AND VERTICAL CLEARANCES
		U	ULS								
STREETS WITH CURB & GUTTER	30	300'	273'	15	200'	10'	CG-6	(10)	5'	2:1	SAME AS CURB TO CURB OF APPROACHES
	20	127'	92'		125'						
	DESIGN SPEED (MPH)	MINIMUM RADIUS		(1) MAXIMUM PERCENT OF GRADE	STOPPING SIGHT DISTANCE	(2) MIN. WIDTH OF LANE	(7) MINIMUM WIDTH GRADED SHOULDERS		(8) WIDTH OF DITCH (FRONT) SLOPE	(6) SLOPES	(9) NEW AND RECONSTRUCTED MINIMUM BRIDGE WIDTHS AND VERTICAL CLEARANCES
		U	ULS				FILL W/GR.	CUT & FILL			
STREETS WITH SHOULDER DESIGN	30	300'	273'	15	200'	10'	7'	4'	4'	3:1	4' + PAVEMENT WIDTH + 4'
	20	127'	92'		125'						

**GENERAL NOTES**

Design Speed is not a major factor for local streets. For consistency in design elements, design speeds ranging from 20 to 30 mph may be used, depending on available right of way, terrain, adjacent development and other area controls.

In the typical street grid, the closely spaced intersections usually limit vehicular speeds, making the effect of a design speed of less significance.

Design speeds exceeding 30 mph in residential areas may require longer sight distances and increased curve radii, which would be contrary to the basic function of a local street.

Standard TC-5.01U (Urban) superelevation based on 4% maximum.

Standard TC-5.04ULS (Urban Low Speed) superelevation based on 2% maximum may be used with a design speed of 45 mph or less (45 mph = 7° maximum).

A minimum 30' width of surfacing or a minimum 30' curb to curb is to be used within incorporated cities or towns to qualify for maintenance payments.

**FOOTNOTES**

- (1) Grades in commercial and industrial areas should be less than 8 percent; desirably, less than 5 percent.
- (2) Where feasible, lanes should be 11' wide and in industrial areas should be 12' wide; however, where available or attainable right of way imposes severe limitations, 9' lanes can be used in residential areas and 11' lanes can be used in industrial areas.
- (3) Or equivalent City or Town design.
- (4) The minimum buffer strip width with no sidewalk or sidewalk space is to be 5'.
- (5) A width of 8' or more may be needed in commercial areas.
- (6) 3:1 and flatter slopes may be used when the right of way is behind the sidewalk (or sidewalk space) in residential or other areas where slopes will be maintained by the property owner.
- (7) When Design year ADT exceeds 2000 VPD, with greater than 5% total truck and bus usage:  
Provide 4' wide paved shoulders when the graded shoulder is 5' wide or greater or provide 3' wide paved shoulders when the graded shoulder is 4' wide. All shoulders not being paved will have the mainline pavement structure extended 1', on the same slope, into the shoulder to eliminate raveling at the pavement edge.
- (8) Ditch slopes to be 3:1 - 4' width.
- (9) Vertical clearance at roadway underpasses for new and reconstructed bridges is to be 16'-6" desirable and 14'-6" minimum (1' additional clearance required for non-vehicular overpasses).
- (10) If a buffer strip is used between the back of curb and sidewalk, it should be 2' minimum.
- (11) For intersection sight distance requirements see [Appendix C, Table C-1-5](#).

**FIGURE A - 1 - 8**

**GEOMETRIC DESIGN STANDARDS FOR SERVICE ROADS (GS-9)**

(1) DEAD END SERVICE ROADS UNDER 25 VPD									
PROPERTIES SERVED	DESIGN SPEED (MPH)	MINIMUM RADIUS	STOPPING SIGHT DISTANCE	MINIMUM PASSING SIGHT DISTANCE	(2) MINIMUM TRAVELED WAY WIDTH	MINIMUM WIDTH OF SHOULDER		(3) WIDTH OF DITCH (FRONT SLOPE)	SLOPES
						FILL W/GR.	CUT & FILL		
1	10	30'	50'	-	12'	4'	2'	3'	(4)
OVER 1	20	127'	125'	800'	14'	5'			

**GENERAL NOTES**

The minimum design speed for service roads should be 20 mph except for one lane service roads serving one property which may have a minimum design speed of 10 mph.

Standard TC-5.01R superelevation based on 8% maximum to be used (See 2001 AASHTO "Green Book").

RELATIONSHIP OF MAXIMUM GRADES TO DESIGN SPEEDS				
TYPE OF TERRAIN	DESIGN SPEED (MPH)			
	10	20	30	40
	GRADES (PERCENT)			
LEVEL	8	8	7	7
ROLLING	12	11	10	9
MOUNTAINOUS	18	16	14	12

**FOOTNOTES**

- (1) For through service roads and dead end service roads with over 25 VPD, use Standards shown for Local Roads and Streets.
- (2) Under adverse conditions, intermittent shoulder sections or turnouts for passing may be required (see page 411, 2004 AASHTO "Green Book").
- (3) Ditch slope to be 3:1.
- (4) Slopes to be same as mainline when service road is parallel to or otherwise visible from the mainline. For other cases, slopes should be in accordance with standards for Local Roads and Streets.

**FIGURE A - 1 - 9**

**GEOMETRIC DESIGN STANDARDS FOR INTERCHANGE RAMPS (GS-RM)**

	RAMP DESIGN SPEED (MPH)	MINIMUM RADIUS	(6) STOPPING SIGHT DISTANCE	(1) MINIMUM RAMP PAVEMENT WIDTHS	MINIMUM WIDTH OF SHOULDER					(5) WIDTH OF DITCH (FRONT SLOPE)	(4) NEW AND RECONSTRUCTED MINIMUM BRIDGE WIDTHS AND VERTICAL CLEARANCES
					RIGHT OF TRAFFIC		LEFT OF TRAFFIC				
			GRADED WIDTH		(2) (3) PAVED WIDTH	GRADED WIDTH		(2) (3) PAVED WIDTH			
						FILL W/GR.	CUT & FILL				
INTERCHANGE RAMPS	60	1204'	570'	16'	11'	8'	9'	6'	4'	10'	6' PLUS PAVEMENT WIDTH PLUS 8'
	50	760'	425'								
	40	465'	305'								
	30	251'	200'								
	25	172'	155'	18'							
	20	108'	125'								
AUXILIARY LANES											AUXILIARY LANE SHOULDER WIDTHS ARE TO BE THE SAME AS MAINLINE THROUGH LANES

**GENERAL NOTES**

The determination of the proper design speed for any particular ramp should be made using guidelines shown in Exhibit 10-56 of the 2004 AASHTO "Green Book".

Standard TC-5.01R is to be used. Maximum ramp superelevation to be 8% (See 2001 AASHTO "Green Book").

Clear Zone and Recoverable Area information can be found in Appendix A, Section A-2 of the Road Design Manual.

RELATIONSHIP OF MAXIMUM GRADES TO DESIGN SPEED			
DESIGN SPEED (MPH)			
15 - 20	25 - 30	35 - 40	45 - 50
GRADES (PERCENT)			
6 - 8	5 - 7	4 - 6	3 - 5

Where topographic conditions dictate, grades steeper than desirable may be used. One-way descending gradients on ramps should be held to the same general maximums, but in special cases they may be 2 percent greater.

**FOOTNOTES**

- (1) Interchange ramp widths shown are for one lane traffic. For two lane or other conditions see Exhibit 10-67 in the 2004 AASHTO "Green Book".
- (2) Shoulder widths on ramps with a design speed of 40 mph or less may be reduced to 6' right, or 3' left, when justifiable. However, the sum of the right and left shoulder shall not be less than 10'. See 2004 AASHTO "Green Book", page 838.
- (3) On ramps with a radius of less than 500', consider (depending on degree of curvature, percent of trucks) the extension of the full pavement structure (on the same slope as the pavement) through the inside paved shoulder area to eliminate raveling of the pavement edge.
- (4) Vertical clearance at roadway underpasses for new and reconstructed bridges is to be 16'-6" desirable and 14'-6" minimum (1' additional clearance required for non-vehicular overpasses).
- (5) Ditch slopes to be 6:1.
- (6) For intersection sight distance requirements see Appendix C, Table C-1-5.

**FIGURE A - 1 - 10**

## **SECTION A-2-CLEAR ZONE GUIDELINES**

### **INTRODUCTION**

If practicable, a traversable recovery area for errant vehicles should be provided beyond the edge of the traveled way (edge of mainline pavement) in order to improve highway safety. Ideally this recovery area or "clear zone" should be free of obstacles such as unyielding sign and luminaire supports, non-traversable drainage structures, utility poles and steep slopes. It must be noted that clear zone roadside design involves a series of compromises between "absolute" safety and "engineering, environmental and economic constraints." The following clear zone guidelines were developed using the 2002 AASHTO Roadside Design Guide.

The recommended width of clear zone as discussed in the Roadside Design Guide is influenced by the traffic volume, speed, and embankment slope (see TABLE A-2-1). The Roadside Design Guide will be used as reference for determination of clear zones for Freeways; Rural and Urban Arterials (with shoulders); and Rural and Urban Collectors (with shoulders) with design speeds of 50 mph or greater and with design year ADT volumes greater than 2000. For Rural and Urban collectors with design speeds less than 50 mph and with a design year ADT less than 2000 and for Local Roads, no minimum required clear zone width will be specified; however, the designer should strive to provide as much clear zone as possible with a minimum 10 foot width. Projects such as RRR, intersection improvements, etc., would not normally be provided with recoverable areas due to the intent of the project to provide minimal improvements and extend the service life of an existing highway for a fraction of the costs of reconstruction or to provide necessary interim improvements.

When adequate right of way is available, urban projects should be designed with shoulders in lieu of curbs (unless city ordinances require otherwise) and they should have clear zone widths consistent with their design speeds, traffic volumes, and embankment slopes as noted in TABLE A-2-1.

In urban and suburban areas where curb is utilized with a design speed of 45 mph or less, a 7.5 foot desirable and 6 foot minimum clear zone beyond the curb face is to be provided (see FIGURE A-2-1). It is policy to place utility poles or other fixed objects outside the clear zone (beyond the sidewalk space or behind the curb in the case of a raised median). However, in rare instances this may be impractical due to prevailing limitations or conditions (example - relocation of utility poles to another corridor may not be economically feasible). When this occurs, an absolute minimum horizontal clearance of 1.5 feet beyond the face of curb is to be provided (per Roadside Design Guide Section 3.4.1 page 3-14) and 2004 AASHTO "Green Book", page 319. The justification for not providing the 7.5 foot desirable or 6 foot minimum clear zone width beyond the curb face is to be documented in the project file (e.g. - F.I. Report, memorandum from Right of Way and Utilities Division, etc.).

When mountable curb is used in urban areas it is desirable to provide the same clear zone as would be provided for with a rural condition. However, if those values cannot be obtained, the clear zone widths for 45 mph or less should be utilized.

**TABLE A-2-1 CLEAR ZONE DISTANCES (IN FEET FROM EDGE OF DRIVING LANE)**

DESIGN SPEED	DESIGN ADT	FORESLOPES			BACKSLOPES		
		6:1 or Flatter	5:1 to 4:1	3:1	3:1	5:1 to 4:1	6:1 or Flatter
40 mph or less	Under 750	7-10	7-10	**	7-10	7-10	7-10
	750-1500	10-12	12-14	**	10-12	10-12	10-12
	1500-6000	12-14	14-16	**	12-14	12-14	12-14
	Over 6000	14-16	16-18	**	14-16	14-16	14-16
45-50 mph	Under 750	10-12	12-14	**	8-10	8-10	10-12
	750-1500	14-16	16-20	**	10-12	12-14	14-16
	1500-6000	16-18	20-26	**	12-14	14-16	16-18
	Over 6000	20-22	24-28	**	14-16	18-20	20-22
55 mph	Under 750	12-14	14-18	**	8-10	10-12	10-12
	750-1500	16-18	20-24	**	10-12	14-16	16-18
	1500-6000	20-22	24-30	**	14-16	16-18	20-22
	Over 6000	22-24	26-32*	**	16-18	20-22	22-24
60 mph	Under 750	16-18	20-24	**	10-12	12-14	14-16
	750-1500	20-24	26-32*	**	12-14	16-18	20-22
	1500-6000	26-30	32-40*	**	14-18	18-22	24-26
	Over 6000	30-32*	36-44*	**	20-22	24-26	26-28
65-70 mph	Under 750	18-20	20-26	**	10-12	14-16	14-16
	750-1500	24-26	28-36*	**	12-16	18-20	20-22
	1500-6000	28-32*	34-42*	**	16-20	22-24	26-28
	Over 6000	30-34*	38-46*	**	22-24	26-30	28-30

\* Where a site specific investigation indicates a high probability of continuing accidents, or such occurrences are indicated by accident history, the designer may provide clear zone distances greater than 30 feet as indicated. Clear zones may be limited to 30 feet for practicality and to provide a consistent roadway template if previous experience with similar projects or designs indicates satisfactory performance.

\*\* Since recovery is less likely on the unshielded, traversable 3:1 slopes, fixed objects should not be present in the vicinity of the toe of these slopes. Recovery of high speed vehicles that encroach beyond the edge of shoulder may be expected to occur beyond the toe of slope. Determination of the width of the recovery area at the toe of slope should take into consideration right of way availability, environmental concerns, economic factors, safety needs, and accident histories. Also, the distance between the edge of the travel lane and the beginning of the 3:1 slope should influence the recovery area provided at the toe of slope. While the application may be limited by several factors, the fill slope parameters which may enter into determining a maximum desirable recovery area are illustrated in FIGURE A-2-4, on page A-40.

Source: The 2002 AASHTO Roadside Design Guide and errata August 2001- February 2003

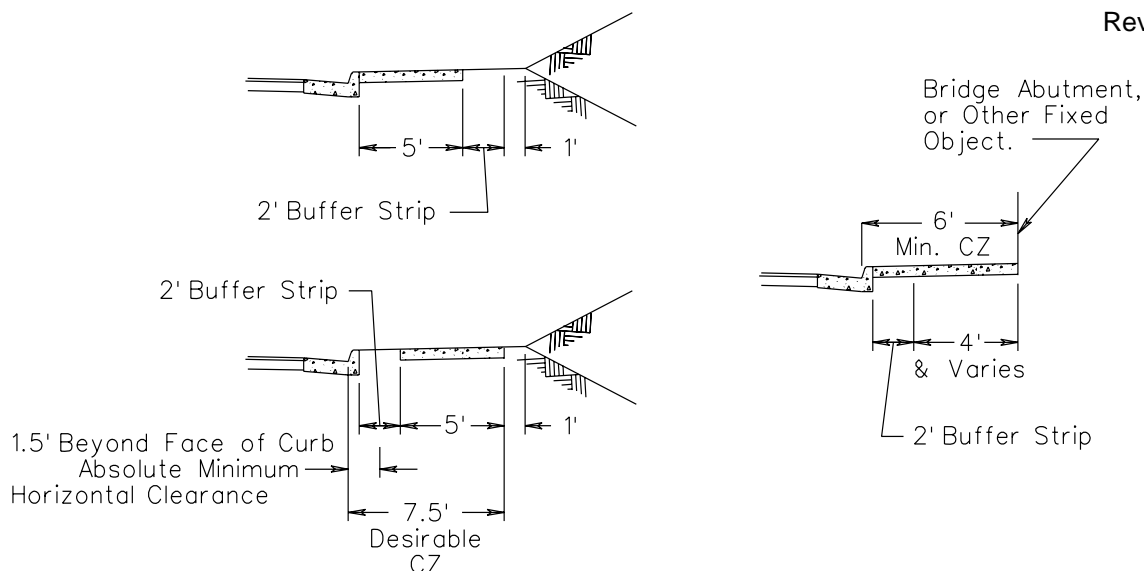

**FIGURE A-2-1**

**URBAN CLEAR ZONE WIDTH GUIDELINES**

**CLEAR ZONE COST-EFFECTIVENESS ANALYSIS**

For projects where the clear zone widths from the AASHTO Roadside Design Guide are under consideration, Freeways; Rural and Urban Arterials (with shoulders); and Rural and Urban Collectors (with shoulders) with design speeds of 50 mph or greater and with a design year ADT greater than 2000, an early cost-effectiveness analysis is required to determine the feasibility of providing the recoverable areas to meet the clear zone requirements shown in TABLE A-2-1. This analysis should be done during the preliminary plan development process and should involve determining the additional construction and R/W costs to provide the desired clear zone. Refer to AASHTO's Roadside Design Guide, Appendix A, for "A Cost-Effective Selection Procedure". Any other procedure which will provide this cost is acceptable as long as it is documented in the project files. After the additional cost to provide the recoverable area is determined, it should be compared to the estimated accident cost without the recoverable area. This cost comparison along with good engineering judgment should be used to determine the feasibility of providing the recoverable areas through the project and should be documented on the Project Scoping Form LD-430 or SR-1 as applicable.

Prior to establishing the additional construction and R/W cost estimate, the developed areas that would involve heavy R/W damages and/or relocations or environmental restrictions such as park properties, historic areas or wetlands should be noted and where practicable horizontal and vertical alignment adjustments are to be made to provide the desired recoverable areas and clear zones. In these situations alternate designs may include elimination of ditches and/or median width reductions with possible incorporation of raised medians or median barrier to reduce required R/W.

A suggested procedure is shown in FIGURE A-2-2 to develop the difference in cost between the typical section based on the project's functional classification and proper Geometric Design Standards and the typical section with the desired recoverable areas.

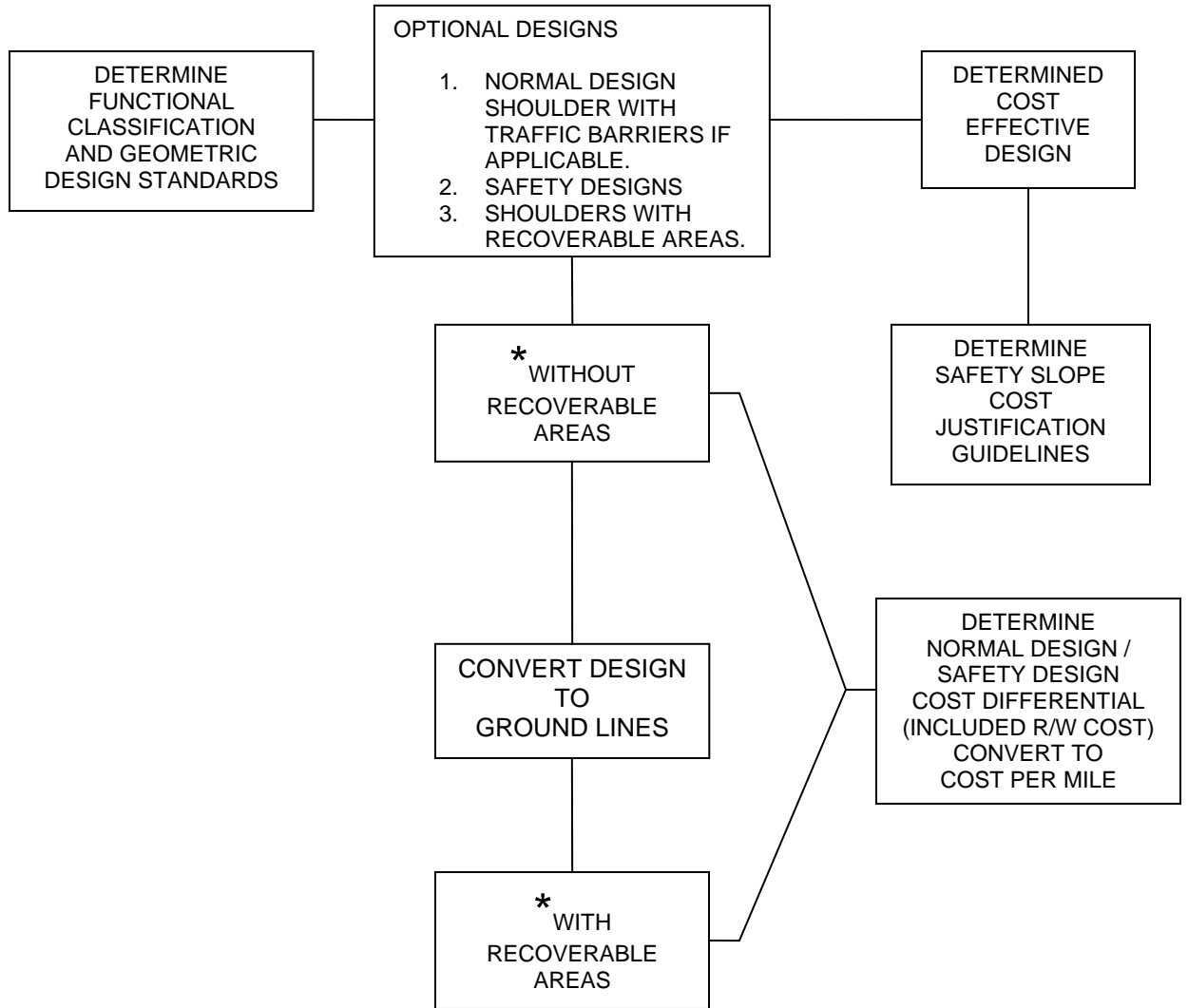

\* GEOPAK  
DESIGN CROSS SECTION LISTING  
EARTHWORK VOLUME COMPUTATIONS

**FIGURE A-2-2**  
**COST EFFECTIVE SELECTION PROCEDURES**

Note: Upon receipt of normal design and safety design earthwork quantities, a cursory review may indicate that the cost per side for the earthwork alone far exceeds the cost per mile for safety slopes, thereby eliminating the need to determine the other additional costs such as drainage extensions, right of way, etc.

**THIS PAGE INTENTIONALLY LEFT BLANK**



**THIS PAGE INTENTIONALLY LEFT BLANK**

## SHOWING CLEAR ZONES ON TYPICAL SECTIONS

The clear zone width(s) is to be clearly shown on the project typical sections if traversable slopes are being provided so that other divisions will be aware of the desirable clear zones for a project. When varying clear zone widths occur, furnish station to station breakdown. Following are typical methods of showing clear zone data on typical sections.

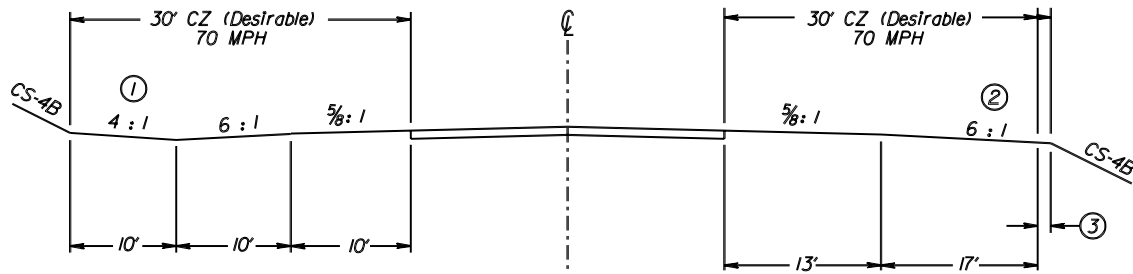

TYPICAL RURAL SECTION

(Other Principal Arterial - Std. CS-4B used for example)  
Design ADT > 6000

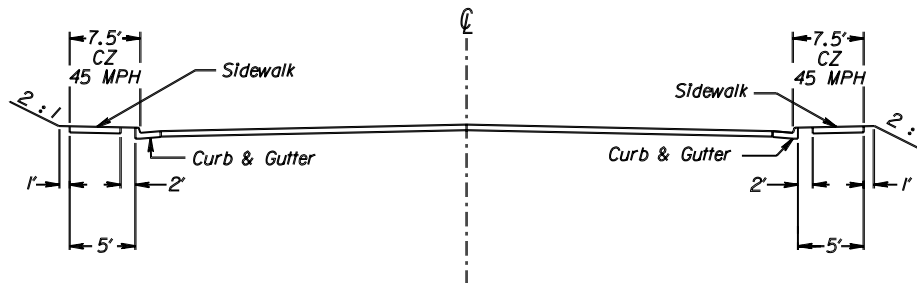

TYPICAL URBAN SECTION

(Minor Arterial Street used for example)

### TYPICAL METHOD OF SHOWING CLEAR ZONE DATA ON TYPICAL SECTIONS

#### NOTES:

1. If the front slope of ditch is 6:1, the back slope should be 4:1, and if the front slope is 3:1, the back slope should be flat.
2. The preferred slope for recoverable areas with fills is 6:1 or flatter.
3. Recoverable area width to be increased 3' if GR-3 or 8 guardrail is required.

## DETERMINING CLEAR ZONE WIDTH

The following is a guide and should be supplemented with sound engineering judgment:

Clear zone (CZ) is defined as the roadside border area, starting at the edge of the traveled way (edge of mainline pavement), available for safe use by errant vehicles. This area may consist of a shoulder, a recoverable slope 4:1 or flatter, a non-recoverable slope between 4:1 and 3:1, and/or a clear run-out area. Previously, 30 ft. was considered to be the standard clear zone, but current guidelines, as shown in TABLE A-2-1, give values greater or less than 30 feet, depending on the roadside slopes, design speeds, and traffic volumes. These values should suggest only the approximate center of a range to be considered and not a precise distance to be held as absolute.

TABLE A-2-1 is to be used by the designer and may be modified by the values shown in TABLE A-2-2. See the 2002 AASHTO Roadside Design Guide for further details.

Embankment slopes must have a relatively smooth and firm surface to be truly recoverable or traversable.

Fill slopes between 3:1 and 4:1 are non-recoverable slopes, defined as one which is traversable, but from which most motorists will be unable to stop or to return to the roadway easily. Vehicles on such slopes typically can be expected to reach the bottom. Since a high percentage of encroaching vehicles will reach the toe of these slopes, the recovery area cannot logically end on the slope. Fixed obstacles should not be constructed along such slopes and a clear runout area (10' min.) at the base is desirable. FIGURE A-2-4 on page A-40 provides an example of a clear zone computation for non-recoverable slopes.

Any non-traversable hazards or fixed objects, including but not limited to those listed in TABLE A-3-1, which are located within the clear zone as determined from TABLE A-2-1, should preferably be removed, relocated, made yielding, or as a last resort, shielded with a barrier.

## HORIZONTAL CURVE ADJUSTMENTS

These modifications are normally only considered where accident histories indicate a need, or a specific site investigation shows a definitive accident potential which could be significantly lessened by increasing the clear zone width and such increases are cost effective.

RADIUS (ft)	DESIGN SPEED (mph)						
	40	45	50	55	60	65	70
2860	1.1	1.1	1.1	1.2	1.2	1.2	1.3
2290	1.1	1.1	1.2	1.2	1.2	1.3	1.3
1910	1.1	1.2	1.2	1.2	1.3	1.3	1.4
1640	1.1	1.2	1.2	1.3	1.3	1.4	1.5
1430	1.2	1.2	1.3	1.3	1.4	1.4	-
1270	1.2	1.2	1.3	1.3	1.4	1.5	-
1150	1.2	1.2	1.3	1.4	1.5	-	-
950	1.2	1.3	1.4	1.5	1.5	-	-
820	1.3	1.3	1.4	1.5	-	-	-
720	1.3	1.4	1.5	-	-	-	-
640	1.3	1.4	1.5	-	-	-	-
570	1.4	1.5	-	-	-	-	-
380	1.5	-	-	-	-	-	-

**TABLE A-2-2**

$$CZ_c = (L_c) (K_{cz})$$

Where

$CZ_c$  = clear zone on outside of curvature, ft.

$L_c$  = clear zone distance ft., Table A-2-1

$K_{cz}$  = curve correction factor

Note: Clear zone correction factor is applied to outside of curves only. Curves flatter than 2860 ft don't require an adjusted clear zone.

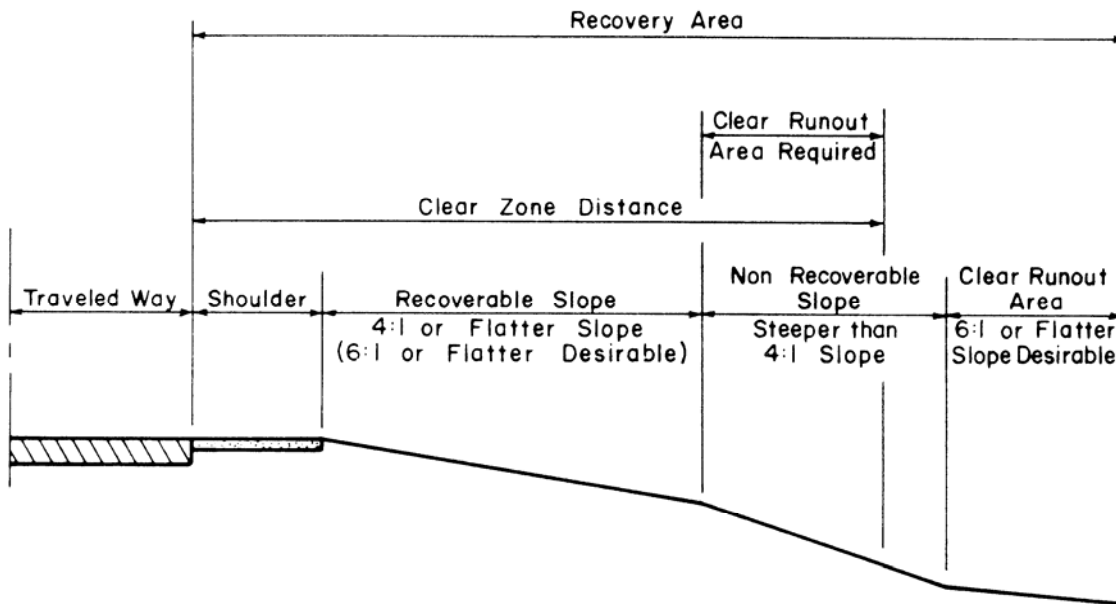

**FIGURE A-2-4 EXAMPLE OF A PARALLEL EMBANKMENT SLOPE DESIGN**

Source: The 2002 AASHTO Roadside Design Guide.

This figure illustrates a recoverable slope followed by a non-recoverable slope. Since the clear zone distance extends onto a non-recoverable slope, the portion of the clear zone distance on such a slope may be provided beyond the non-recoverable slope if practical. This clear runout area would then be included in the total recovery area. The clear runout area may be reduced in width based on existing conditions or site investigations. Such a variable slope typical section is often used as a compromise between roadside safety and economics. By providing a relatively flat recovery area immediately adjacent to the roadway, most errant motorists can recover before reaching the steeper slope beyond. The slope break may be liberally rounded so an encroaching vehicle does not become airborne. It is suggested that the steeper slope be made as smooth as practical and rounded at the bottom.

## NON-RECOVERABLE PARALLEL SLOPES

Embankment slopes from 3:1 up to 4:1 are considered traversable if they are smooth and free of fixed object hazards. However, since many vehicles on slopes this steep will continue on to the bottom, a clear run-out area beyond the toe of the slope is desirable. The extent of this recovery area could be determined by first finding the available distance between the edge of the traveled way and the breakpoint of the recoverable slope to the non-recoverable slope. This distance is then subtracted from the total recommended clear zone distance based on the slope that is beyond the toe of the non-recoverable slope. The result is the desirable clear run-out area. The following example illustrates this procedure:

### EXAMPLE

Design ADT: 7000

Design Speed: 60 mph

Recommended clear zone distance for the 8:1 slope: 30-32 feet (from  
TABLE A-2-1)

Recovery distance before breakpoint of slope: 15 feet

Clear runout area at toe of slope: 30-32 feet minus 15 feet or 15-17 feet

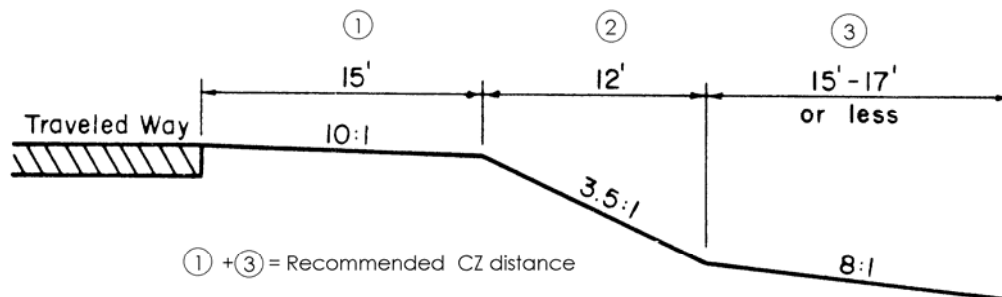

(For Example of Alternate Design to reduce CZ requirement, see below)

Discussion: Using the steepest recoverable slope before or after the non-recoverable slope, a recovery distance is selected from Table A-2-1. In this example, the 8:1 slope beyond the base of the fill dictates a 30-32 foot recovery area. Since 15 feet are available at the top, an additional 15-17 feet could be provided at the bottom. All slope breaks may be rounded and no fixed objects would normally be built within the upper or lower portions of the clear zone or on the intervening slope.

The designer may find it safe and practical to provide less than the entire 15-17 feet at the toe of the slope. A smaller recovery area could be applicable based on the rounded slope breaks, the flatter slope at the top, or past accident histories. A specific site investigation may be appropriate in determining an appropriate recovery area at the toe of the slope.

Example of Alternate Design (incorporating minor slope adjustment) to reduce total clearance requirement.

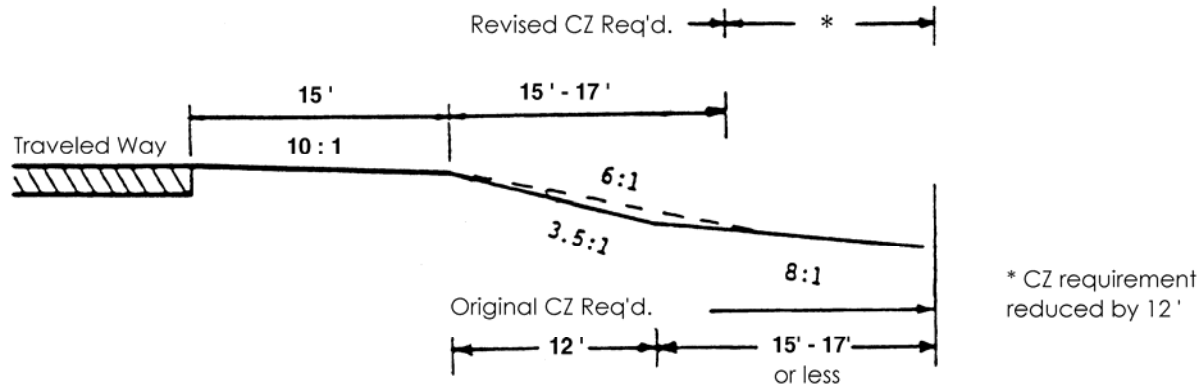

When traffic barriers must be provided because hazardous conditions can not be eliminated, see Section A-3-Barrier Installation Criteria.

## SECTION A-3-TRAFFIC BARRIER INSTALLATION CRITERIA

### INTRODUCTION

Traffic Barriers should only be used where the result of striking a fixed object hazard or leaving the roadway would be more severe than the consequence of striking the barrier.

Where guardrail needs are indicated by warrants see the current AASHTO Roadside Design Guide. The roadway should be examined to determine the feasibility of adjusting site features so that the barrier will not be required (e.g. flattening a fill slope, removing a hazardous object such as a drainage headwall, etc.). The initial cost to eliminate the guardrail may appear excessive; however, the fact that a barrier installation will require maintenance costs for many years should not be overlooked.

### GUARDRAIL WARRANTS

The determining warrants for Traffic Barriers on VDOT projects are (1) Embankment Heights (see below) and (2) Fixed and Hazardous Objects Within the Clear Zone (see TABLE A-3-1).

SYSTEM CLASSIFICATION		TRAFFIC VOLUMES	FILLS OVER 7.5'	FILLS OVER 15'	AT OBVIOUS NEEDS SUCH AS BRIDGES, LARGE END WALLS, PARALLEL WATER HAZARDS, ETC., AND FILLS WHERE RECOMMENDED DURING FIELD INSPECTION
INTERSTATE - PRIMARY AND ARTERIAL	FILLS WITHOUT RECOVERABLE AREAS	ALL	√		√
	FILLS WITH RECOVERABLE AREAS				√
SECONDARY AND FRONTAGE ROADS		ADT OVER 1000	√		√
		ADT 1000 - 250		*√	√
		ADT LESS THAN 250			√
URBAN		ALL			√

\* Exception - Bristol, Salem, and Staunton Districts. Traffic barriers are to be provided only at obvious needs such as bridges, large endwalls, parallel water hazards, etc., and fills where recommended at field inspection.

When fill slopes are 3:1 or flatter, a barrier is not required unless there are hazardous obstacles within the clear zone limits. This may include the clear runout area if the fill slope is between 3:1 and 4:1 (see Fig. A-2-4).



## DETERMINING WARRANTS FOR ROADSIDE BARRIERS

<u>Fixed and Hazardous Objects Within The Clear Zone</u>		<u>Guardrail Required</u>	
		YES	NO
1.	Sign Support (ground mounted): (A) Post of breakaway design (a)		X
	(B) Post not meeting breakaway criteria (b)(c)(d)	X	
2.	Lighting/Signal Poles and Towers (A) Breakaway design		X
	(B) Not meeting breakaway design (b)(c)(g)(h)	X	
3.	Bridge parapet ends, piers and abutments at underpasses	X	
4.	Retaining walls and culvert headwalls	X	
5.	Trees with a diameter of 4 inches or greater (e)	X	
6.	Utility Poles (f)		X
7.	Above ground utilities (telephone pedestals, etc.) (i)	X	
8.	Rough rock cuts and large boulders	X	
9.	Streams or permanent bodies of water more than 2 feet deep (h)	X	
<p><b>NOTES</b></p> <p>(a) Multiple post installations where the spacing between posts is less than the minimum spacing required for breakaway shall be replaced or shielded by guardrail.</p> <p>(b) Every effort should be made to convert non-breakaway to breakaway.</p> <p>(c) Where these devices exist and cannot be converted to breakaway, relocated or removed, the choice of guardrail should be in accordance with the deflection shown in Table A-3-2.</p> <p>(d) Wood posts larger than 6" x 8" nominal size do not meet the breakaway requirements even if drilled.</p> <p>(e) Every effort should be made to remove the tree rather than shield it with guardrail.</p> <p>(f) Guardrail will not normally be used to shield a line of utility poles. However, where guardrails are used in front of utility poles for other reasons, the choice of guardrail should be in accordance with the deflection shown in Table A-3-2.</p> <p>(g) Pedestal poles, except for those used for power supply, should be converted to breakaway standards where possible.</p> <p>(h) A field review and evaluation should be made to determine if guardrail is suitable for protecting motorists from these roadside hazards.</p> <p>(i) Consideration should be given to placing utilities underground.</p>			

**TABLE A-3-1**

## BARRIER TYPE SELECTION

When it has been determined that a barrier is required, a determination must be made as to the type of barrier that is to be used. Although the process is complicated by the number of variables and the lack of objective criteria, there are guidelines that can be used in making a barrier system selection. In general, the most desirable system is one that offers the lowest accident severity at the least cost and is consistent with the given constraints. The Standard GR-8 Weak Post System is to be used only when speeds are  $\leq 45$  m.p.h.

The AASHTO Roadside Design Guide presents eight items which must be considered before a system selection is made. In taking all eight items into account, the deflection, strength, and safety requirements should never be compromised. Table A-3-2 groups the Standard types of guardrail by three systems: flexible, semi-rigid and rigid. The table includes barrier height, maximum dynamic deflection, minimum offset from hazardous object, post spacing, and typical terminal treatment for each Standard. The Road and Bridge Standards provide transition designs for use in various situations.

SYSTEM	STANDARD	MINIMUM BARRIER HEIGHT	MAXIMUM DYNAMIC DEFLECTION (A)	MINIMUM OFFSET FROM HAZARD (C)	POST SPACING	DIVIDED ROADWAY OR ONE-WAY TRAFFIC		UNDIVIDED ROADWAY OR TWO-WAY TRAFFIC	
						RUN-ON TERMINAL TREATMENT	RUN-OFF TERMINAL TREATMENT (D)	RUN-ON TERMINAL TREATMENT	RUN-OFF TERMINAL TREATMENT
FLEXIBLE (WEAK POST OR CABLE)	GR-3	27"	11'	11'	16'-0"	GR-3	GR-3	GR-3	GR-3
	GR-8 (L)	30"	7'	7'	12'-6"	GR-6,7,9 (H)	GR-8, TY. II	GR-6,7,9 (E) (H)	GR-6,7,9 (E) (H)
	GR-8A	30"	5'	5'	6'-3"	GR-6,7,9 (H)	GR-8, TY. II	GR-6,7,9 (E) (H)	GR-6,7,9 (E) (H)
	GR-8B	30"	4'	4'	3'-1 1/2"	GR-6,7,9 (H)	GR-8, TY. II	GR-6,7,9 (E) (H)	GR-6,7,9 (E) (H)
	GR-8C	30"	4'-6"	4'-6"	4'-2"	GR-6,7,9 (H)	GR-8, TY. II	GR-6,7,9 (E) (H)	GR-6,7,9 (E) (H)
	MB-5 (F)	30"	7'	7'	12'-6"	IMPACT ATT.	IMPACT ATT.	N/A	N/A
	MB-5 (F)	30"	5'	5'	6'-3"	IMPACT ATT.	IMPACT ATT.	N/A	N/A
	MB-5 (F)	30"	4'	4'	3'-1 1/2"	IMPACT ATT.	IMPACT ATT.	N/A	N/A
SEMI-RIGID (STRONG POST)	GR-2	27"	3'	3'	6'-3"	GR-6,7,9 (H)	W BEAM	GR-6,7,9 (H)	GR-6,7,9 (H)
	GR-2A	27"	2' (B)	2'	3'-1 1/2"	GR-6,7,9 (H)	END SECTION	GR-6,7,9 (H)	GR-6,7,9 (H)
	MB-3 (G)	27"	3'	3'	6'-3"	IMPACT ATT.	IMPACT ATT.	N/A	N/A
RIGID (CONCRETE BARRIER)	MB-7D, 7E 7F, 12A, 12B, & 12C (k)	32"	0'	0'	N/A	IMPACT ATTENUATOR (l)	N/A	IMPACT ATTENUATOR (l)	IMPACT ATTENUATOR (l)

**TABLE A-3-2 – TYPICAL BARRIER/GUARDRAIL SELECTION AND PLACEMENT**

**NOTES:**

- (a) The deflection zone of all rail systems must be totally clear of any obstacles in order to assure that the rail will perform as tested.
- (b) No test data available.
- (c) Minimum offset from back of post to hazardous object.
- (d) The noted terminal treatments apply when the terminal is installed outside the clear zone for opposing traffic. If a run-off terminal is installed within the clear zone of opposing traffic, see note "e".
- (e) Transition from weak post system to terminal must be provided in accordance with St'd. GR-INS drawings to protect opposing traffic from impacting the opposite end of the terminal when it falls within clear zone.
- (f) For use in wide flat medians (>30 feet).
- (g) For use in narrow medians (approximately 10-30 feet).
- (h) If more than a 200' extension of standard guardrail is necessary to tie into the slope with a St'd. GR- 6, terminal, use a St'd. GR-7 or GR-9 terminal. For St'd. GR-6 installations, St'd. GR-2 must be installed from the terminal to the beginning of the flare before introducing St'd. GR-8.
- (i) Concrete turned down terminals may be used for locations outside clear zone.
- (k) For use in medians 0-30 feet wide.
- (j) GR-8 is not acceptable on projects with design speeds greater than 45 m.p.h.

## **GUARDRAIL INSTALLATION IN URBAN SETTINGS**

In Urban settings with speeds of 45 MPH or less that include curb or curb and gutter, the use of guardrail is not recommended. Standard CG-2 or CG-6 (6" high curb) is usually used for speeds of 45 MPH or less in urban and suburban areas and is referred to as "barrier curb" because it has a 6" vertical face and is intended to discourage motorists from deliberately leaving the roadway. Even when CG-3 or CG-7 (4" high mountable curb) is used in Urban settings, it is impractical to install guardrail in an attempt to protect pedestrians walking along sidewalks due to the lack of accessibility caused when placing guardrail and terminals adjacent to accessible routes.

When curbed sections do not include sidewalk or sidewalk space and hazards exist that warrant guardrail, St'd. GR-2 (Strong Post) guardrail (which includes a blockout) should be installed with the face of the rail aligned with the face of the curb. This decreases the possibility of an errant vehicle striking the curb before impacting the guardrail or from snagging the guardrail posts. If possible, to provide maximum offset, the guardrail should be placed 11' or more behind the curb for high speed (50 mph or more) roadways and 6' or more behind the curb for low speed (40 mph or less) roadways. The guardrail height when placed at the curb is measured from the roadway surface. When offset from the curb, it is measured from the ground beneath the rail. St'd. GR-8 (Weak Post) guardrail should not be used adjacent to asphalt or concrete curb.

Sometimes hazards that need to be shielded exist on urban projects with sidewalk/sidewalk space. In situations like this, guardrail can be placed behind the sidewalk and in front of the hazard. Examples of such hazards are ponds, steep embankments, etc.. When these situations arise, sound engineering judgment should be used in deciding whether/where to place the guardrail. If the hazard is within the clear zone, a barrier would be warranted. The hazards that are outside the clear zone are the items that require an engineering decision based on evaluation of all the elements within the design site.

## **GUARDRAIL LOCATIONS ON FIELD INSPECTION PLANS**

The approximate locations of barriers should be shown on Preliminary Field Inspection plans and discussed at the [Preliminary Field Inspection](#). If the locations are not shown, the type, terminals, and placement should be generally discussed. Maintenance of areas protected by barriers should also be discussed at this time.

### DETERMINING LOCATION OF THE ENDS OF GUARDRAIL

Figure A-3-1 and Table A-3-3 give a method to determine the location of the end of guardrail systems. Appropriate terminals shall be placed at this point.

Condition showing hazard for adjacent traffic

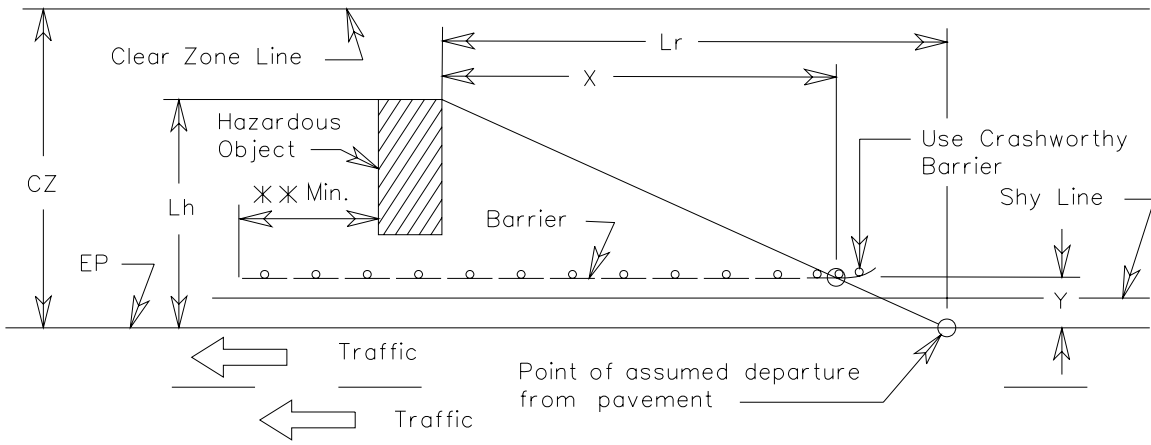

Condition showing hazard for opposing traffic

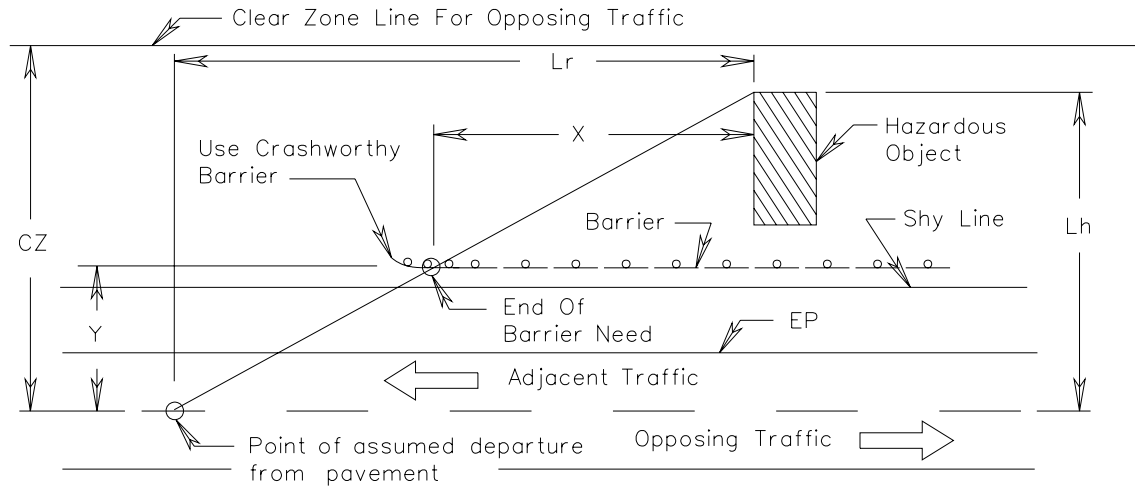

**FIGURE A-3-1 - BARRIER LENGTH OF NEED DETERMINATION**

$$X = (1 - Y/L_h) L_r$$

- X = Length of Need
- CZ = Clear Zone Width
- Lh Max. = CZ
- Lr = Runout length (See table A-3-3)
- LS = Shyline

- \*\* = 25' for GR-2
- = 12.5' for GR-2A
- = 25' plus a Type II for GR-8
- = 1' for MB-7C

DESIGN SPEED (MPH)	DESIGN TRAFFIC VOLUME (ADT)				*	FLARE RATE		
	OVER 6000	2000-6000	800-2000	UNDER 800		SHY LINE (FT)	BEYOND SHY LINE	
	RUNOUT LENGTH	RUNOUT LENGTH	RUNOUT LENGTH	RUNOUT LENGTH	GR-2, 3 & 8 MB-3		MB-7D, 7E,7F,12A,1 2B,&12C	ALL
	Lr(FT)	Lr(FT)	Lr(FT)	Lr(FT)				
70	475	445	395	360	9.2	15:1	20:1	30:1
60	425	400	345	330	7.9	14:1	18:1	26:1
55	360	345	315	280	7.2	12:1	16:1	24:1
50	330	300	260	245	6.6	11:1	14:1	21:1
45	260	245	215	200	5.6	10:1	12:1	18:1
40	230	200	180	165	4.6	8:1	10:1	16:1
30	165	165	150	130	3.6	7:1	8:1	13:1

- Shy line is measured from the adjacent edge of pavement and is a distance beyond which a roadside object will not be perceived as a threat by a driver. In other words, a driver will not react to an object beyond the shy line offset. If possible, the roadside barrier should be placed beyond the shy line offset.

Source: The 2002 Roadside Design Guide Tables 5.5, 5.7 & 5.8

**TABLE A-3-3**

**DESIGN PARAMETERS FOR ROADSIDE BARRIER LAYOUT**

**SLOPES FOR APPROACH BARRIERS**

As a general rule, a roadside barrier should not be placed on an embankment if the slope of the embankment is steeper than 10:1; however, in special cases, such as "barn roof" ("recoverable area") slopes, it is acceptable to place semi-rigid barrier on slopes as steep as 6:1. When semi-rigid barrier is used on 6:1 slopes, a 10-foot rounding should be included between the shoulder and slope. Where it is not feasible for the entire graded median in the area of the hazard to be on a 10:1 slope, an acceptable alternative is to provide the 10:1 slope between the edge of pavement and the approach barrier (See Fig. A-3-2). A clear run-out path should also be provided behind the terminal.

When recoverable areas are less than 14 feet in width and guardrail is required, the guardrail is to be placed using at least the minimum fill shoulder width specified in the Geometric Design Standard and the recoverable area is not to be provided. Although not encouraged, guardrail is permitted on 6:1 slopes if located beyond 12 feet of the shoulder hinge point.

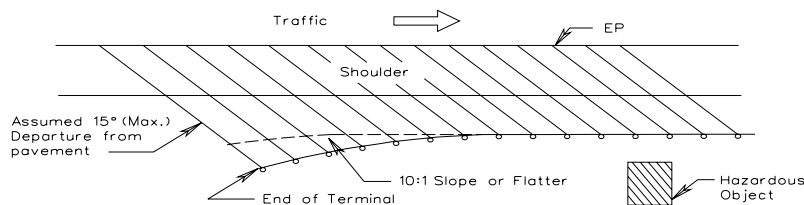

**FIGURE A-3-2 - SUGGESTED SLOPES FOR APPROACH BARRIERS**

## **FIXED OBJECTS WITHIN DEFLECTION AREA**

No fixed objects, regardless of their distances from the edge-of-pavement, will be allowed within the deflection zone of the guardrail system to assure that the barrier system will perform as designed. This will include overhead sign supports, walls, drainage structures, bridge piers, signal supports, utility poles, trees, etc.. Additionally, the deflection zone must be free of breakaway signs, signals, and luminaire supports since their performance when struck by deflecting guardrail is unknown and untested. If a sign or luminaire support must remain within the deflection zone, it must be a breakaway design.

When it is impractical to locate these obstacles outside of the deflection zone of a particular type of guardrail (e.g., GR-8 = 7', GR-8B = 4'), it will be necessary to strengthen the guardrail to decrease deflection or to use a different type of guardrail or barrier which has less deflection so the object is shielded within the clear zone.

Methods of stiffening the rail include decreasing post spacing and double nesting of rail elements. Each stiffening method typically halves the deflection. The stiffening method should begin 18' in advance of the hazard and continue at least to the end of the hazard. Plans fitting these criteria are to be submitted to the Engineering Services Section for review, approval and details.

Table A-3-2 (Typical Barrier/Guardrail Selection and Placement) specifies the minimum offset distance required from "hazardous objects" to meet deflection requirements of the different types of barrier systems.

## **FIXED OBJECT ATTACHMENT/TRANSITIONS POLICY**

A transition section is needed where flexible (weak post) roadside guardrail must join a rigid bridge railing, concrete barrier, retaining wall, etc. The transition design produces a gradual stiffening of the overall approach protection system so vehicular pocketing, snagging, or penetration can be reduced or avoided at any position along the transition.

A transition is also needed when a GR-6, GR-7, or GR-9 terminal is used on the run-off end of a flexible (weak-post) guardrail system on undivided roadways with two-way traffic to protect opposing traffic from impacting the opposite end of the terminal. The Road and Bridge Standards include details on guardrail transitions.

A rub rail is provided in Standards GR-FOA-1, -2, and -4 to help prevent potential vehicular snagging at the immediate upstream end of the rigid bridge railing. The rub rail is not necessary on the Special Design GR-FOA-3 as it is attached to a flared terminal wall that has a transitioned face to prevent snagging. Special Design GR-FOA-3 will be retained for use only on bridges that have been designed with the flared terminal wall.

## ENTRANCES OR CONNECTIONS ADJACENT TO A BRIDGE

When entrances or connections cannot be relocated or eliminated and are located adjacent to a bridge on low-volume rural roads or in areas with dense entrance locations, it is necessary to install radial guardrail around the entrances or connections.

Plans fitting this criteria are to be submitted to the [Engineering Services Section](#) for review, approval and details.

## GUARDRAIL OVER CULVERT IN FILLS

Standard GR-10, Type I, II, or III is the preferred method of installing guardrail over culverts where fills are less than 3'-7" above culvert the top slab.

Type I is adaptable to culverts with a perpendicular width of 10'-6" or less. A 25' section is used with the rail doubled and one post omitted. Type II is adaptable to culverts with a perpendicular width of 16'-9". A length of 37'-6" is used with the rail doubled and two posts omitted. Type III is for use with a perpendicular width of 23'. A length of 100" is used with the rail doubled and three posts omitted.

In situations where the use of Standard GR-10 is not feasible, an allowable alternative may be the TEXAS T-6 (BGR-01) for speeds  $\leq$  45 m.p.h.

## SHORT GAPS

Short gaps between barrier installations should be avoided. When the areas of concern are less than 200 feet apart, the barrier protection shall be made continuous.

## PONDS OR OTHER BODIES OF WATER

Barrier is to be constructed on all functional classifications at ponds or other bodies of water over 2 feet in depth.

## TERMINAL REQUIREMENTS

Guardrail/barrier terminals are to be provided for all installations regardless of "Functional Classification". Terminals develop the necessary tension at the end of the system in order to redirect a vehicle and, if hit, minimize the damage to a vehicle and its occupants. The termini of guardrail/barrier must be designed and located so there are no exposed rail element ends within the clear zone which a vehicle could impact.

### (1) Flexible (Weak Post or Cable) Guardrail Installations -

Cable guardrail should normally be used only on Limited Access projects which provide "Recoverable Areas" exceeding 14 feet in width. Cable guardrail should be introduced when the height of fill slopes exceed 20 feet. This height is based on the hinge point between 6:1 slopes and 2:1 slopes. If the introduction of cable guardrail is in close proximity to an adequate cut section, it should be



extended and terminated in the back slope of the cut ditch. (Use 15:1 transition for Design Speeds of 70 MPH or 13:1 transition for Design Speeds of 60 MPH or less). Standard GR-3 (Cable Guardrail) is terminated on both the run-on and run-off ends with an anchor assembly as detailed in St'd. GR-3.

When using GR-8 (Weak Post Guardrail), the preferable run-on terminal is St'd. GR-6, terminal which buries the end of the guardrail into a cut slope and anchors the terminal with a post or concrete block. This terminal treatment requires enough right of way to extend the guardrail a minimum of 12'-6" beyond the ditch line. The guardrail should terminate a minimum of 1' below the ground elevation of the backslope. The rail preceding the GR-6 terminal is to maintain a consistent height (30") from the ground elevation to the top of the rail to prevent errant vehicles from impacting at an improper height. A total length of St'd. GR-8 (Weak Post Guardrail) based on the appropriate flare for the design speed shown on the standard drawing should be used adjacent to the St'd. GR-6 terminal. If more than a 200 foot extension of St'd. GR-8 guardrail is necessary to tie into the slope with a Std. GR-6 terminal, it would not be cost effective. If the GR-8, Type II terminal installation is not feasible, a St'd. GR-7 (Breakaway Cable Terminal) or GR-9 (Strong Post Alternate Breakaway Cable Terminal) including appropriate transitions should be used.

For run-off terminal treatment with St'd. GR-8 (weak post guardrail), the St'd. GR-8, Type II terminal is acceptable only for divided roadways or one-way traffic situations. When two-way traffic on an undivided facility would introduce the possibility of opposing traffic impacting an intended run-off terminal for another lane, a GR-6, GR-7 or GR-9 terminal must be used. Because the possibility would then exist for opposing traffic to impact the opposite end of the terminal, a transition (in accordance with the Road and Bridge Standards) must be used to join the St'd. GR-6, GR-7 or GR-9 terminal and the weak post guardrail system (GR-8) to minimize any possible impacts.

## (2) Semi-Rigid (Strong Post) Guardrail Installations -

With Standard GR-2 (Strong Post Guardrail), the preferred run-on terminal treatment on divided and undivided roadways is to bury the end of the guardrail into a cut slope, using St'd. GR-6 terminal, even if the guardrail must be extended 200 feet to accomplish this. If more than a 200 foot extension of St'd. GR-2 (Strong Post Guardrail) is necessary to tie a St'd. GR-6 terminal into the back slope, cost-effectiveness would justify use of a St'd. GR-7 (Breakaway Cable Terminal) or GR-9 (Alternate Breakaway Cable Terminal). Run-off terminals for use with undivided roadways with two-way traffic are handled in the same manner. However, for the run-off terminal on a divided roadway or with one-way traffic, a W-Beam End Section treatment in accordance with St'd. GR-HDW details is sufficient to terminate the St'd. GR-2.

### (3) Rigid (Concrete Barrier) Installations -

St'd. MB-7D, 7E, 7F, 12A, 12B and 12C Concrete Median Barriers are considered rigid installations, thus requiring special attention to the terminal treatment to minimize the hazard if impacted. For run-on treatment outside the clear zone and all run-off treatment, a concrete turned down terminal can be used to terminate concrete barrier.

A Standard Insertable Sheet is available in the CADD Insertable Sheet directory for a 12 foot section of the turned down terminal. A special design Impact Attenuator must be requested for all sites within the clear zone where concrete median barrier must be terminated.

## TERMINAL INSTALLATION

### (1) GR-8, Type II, Terminal Treatment Installation:

The St'd. GR-8, Type II, terminal is used only as a means of anchoring the run-off end of GR-8 (Weak Post) guardrail on divided or one-way roadways when installed outside the clear zone for opposing traffic. The guardrail is to be flush with the concrete anchor throughout the length of the anchor assembly in order for the installation to function properly without shearing the bolts.

### (2) GR-6 Terminal Treatment Installation:

The St'd. GR-6 terminal is used as a means of terminating run-on or run-off ends of St'd. GR-2 or GR-8 guardrail on divided or undivided roadways by burying the end of the guardrail into the cut slope.

### (3) GR-7 Breakaway Cable Terminal Installation:

When using the St'd. GR-7 terminals on standard shoulders, the 4-foot flare as specified in the standard drawing or manufacturer's specifications must be provided for the installation to function as tested. This is considered essential to proper performance for end-on impacts to eliminate the potential of spearing. In consideration of the 4-foot flare requirement to construct the terminal treatment for St'd. GR-7, the shoulder in the terminal area must be widened sufficiently to accommodate site preparation for the terminal. The terminal should be located, or the barrier may need to be extended as needed, to provide a clear run-out path behind the terminal.

On bridge replacement projects and other projects (involving guardrail updates) on which existing shoulders are of insufficient width and for which there are no provisions for widening such shoulders, additional fill material is required to be placed to ensure that the flare can be correctly installed. Typical installation details are shown in Standard GR-SP with a tabulation of the applicable widths. (Projects with paved shoulders - Details are shown on Special Design Drawing No. 2154-A, Asphalt Paving Under Guardrail).

When this situation occurs for the GR-7 terminals on projects without normal grading operations, a pay item [Guardrail Terminal site preparation (GR-SP) - Item Code 13349 with pay unit of Each] is to be used to cover the required embankment, benching and reseeding.

(A Special Provision Copied Note is available for use in contracts involving this pay item.)

New construction projects provide the necessary shoulder widening for the required guardrail terminals; therefore, the separate pay item for site preparation is not applicable.

(4) GR-9 Alternate Breakaway Cable Terminal Installation:

If the 4 foot offset cannot be achieved to properly install the Standard GR-7 terminal, evaluate using a St'd. GR-9 or request a special design terminal treatment from the Engineering Services Section. The GR-9 terminal treatment should only be used after an analysis including additional right of way costs indicates it is more cost effective than providing the proper site preparation to install a St'd. GR-7 or to extend the guardrail (200' maximum) to provide a St'd. GR-6 terminal. The estimated cost of the GR-9 terminal is \$2000.

The GR-9 terminal is intended solely for use on the end of a w-beam installation with no flare. The guardrail is anchored in a manner similar to the standard breakaway cable terminal and redirects side-impacting vehicles. For an "end-on" hit, the terminal essentially flattens and slides backward, absorbing crash energy.

The total length of the terminal is 50 feet. The length of need begins 12.5 feet from the first post. The maximum deflection for the terminal along the length of need is 4 feet. For GR-9 installations used to terminate GR-8 (weak post guardrail), an additional 50-foot transition of St'd. GR-2 (wood posts only) is required.

(5) W-Beam End Section Installation:

For run-off treatment on a divided or one-way roadway, St'd. GR-2 (Strong Post) guardrail can be terminated with a W-Beam End Section in accordance with the Standard GR-HDW details as long as the installation is outside the clear zone for opposing traffic. The "flared" or "rounded" treatment may be used if installed outside the clear zone for opposing traffic. Payment is length of St'd. GR-2 guardrail

## IMPACT ATTENUATORS (CRASH CUSHIONS)

During the preliminary design stages for new construction and for rehabilitation or reconstruction of existing highways, the need for and space requirements of crash cushions to shield non-removable fixed objects should be considered. This will ensure compatibility with the final design and the crash cushion that is to be installed. Since these devices are expensive to install and maintain, the hazard must be studied to determine if elimination is possible or its inherent hazard potential can be economically reduced to tolerable limits by less drastic safety treatments, such as guardrail, breakaway supports, set-back, safety shape, etc. Present procedure requires that the proposed site be selected by the roadway designer and reviewed by the Special Design section for the type of crash cushion to be used. When requesting the review and installation details from the Special Design section, submit a print of the plans with a transmittal slip giving the project number, PPMS numbers, activity number, roadway design speed and advertisement date. In no case will attenuation devices be designed for placement behind curbed locations. For additional data, refer to the AASHTO's Roadside Design Guide.

In 1993 the National Cooperative Highway Research Program (NCHRP) published NCHRP Report 350. As a result of that report the FHWA issued a requirement that all permanent safety hardware systems included in Federal Aid projects after August 1998 meet NCHRP 350. VDOT extended that requirement to include state funded projects as well.

Devices subjected to traffic speeds greater than 45 mph must meet NCHRP 350 Test Level 3.

Devices subjected to traffic speeds of 45 mph and less must meet NCHRP 350 Test Level 2.

For a list of approved devices see Instructional and Informational Memorandum LD-222.

Fixed roadside hazards vary in size and shape, and in the degree of danger they present. The traffic passing by varies as well in volume, speed and density. For these reasons a selection from various types of crash cushions can be designed to meet the special requirements of a particular hazard site.

Figure A-3-3 suggests the area that should be made available for crash cushion installation. Although it depicts a gore location, the same recommendations will generally apply to other types of fixed object hazards that require shielding. The unrestricted conditions represent the minimum dimensions for all locations except for those sites where it can be demonstrated that the increased costs for obtaining these dimensions (as opposed to those for restricted conditions) will be unreasonable. The preferred condition dimensions should be considered optimum. The space provided by these dimensions will seldom be fully used by a crash cushion.

These dimensions are recommended so there will be additional space available should experience dictate the need for a device capable of slowing larger vehicles than originally considered or for producing lower deceleration forces. In the meantime, the unoccupied space provides valuable motorist recovery area. Site conditions may dictate the type of attenuator needed. For example, fixed objects such as barrier ends which are less than 3 feet wide should be shielded by a narrow crash cushion. Similarly, wide hazards, e.g., those greater than 3 feet, can be effectively shielded best by a wide impact attenuator or approved sand barrier arrays.

Design Speed on Main line [mph]	Dimensions for Crash Cushion, Reserve Area [feet]								
	Minimum						Preferred		
	Restricted Conditions			Unrestricted Conditions					
	N	L	F	N	L	F	N	L	F
30	6	8	2	8	11	3	12	17	4
50	6	17	2	8	25	3	12	33	4
70	6	28	2	8	45	3	12	55	4
80	6	35	2	8	55	3	12	70	4

Source: The errata August 2001-February 2003 of the 2002 AASHTO Roadside Design Guide.

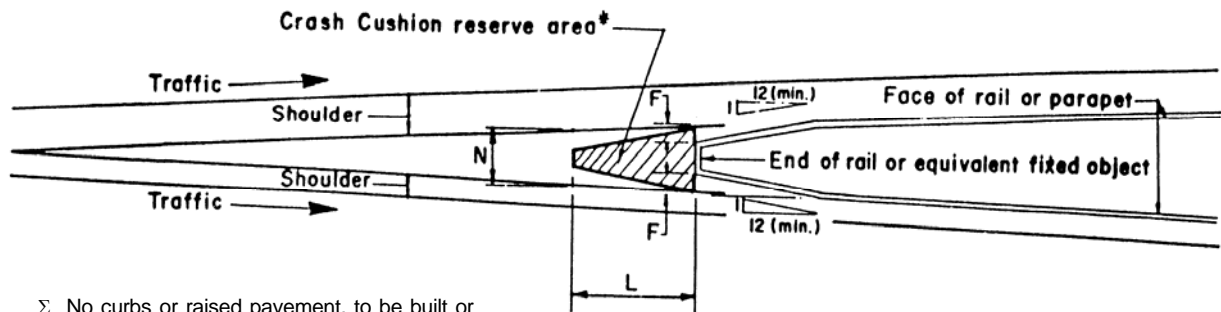

**FIGURE A-3-3**

Source: The 1988 AASHTO Roadside Design Guide.

## BRIDGES

When the proposed design calls for the utilization of an existing bridge having the older type parapet walls or rails, an appropriate detail showing the "Recommended Method for Attaching Guardrail to Bridge Rails" is to be obtained from the Engineering Services Section for inclusion in plans. Prints of the existing bridge rail should accompany the request. The method of measurement and basis of payment is for "Special Design Guardrail Bridge Attachment, (B or Str. No.), Lump Sum" which price bid shall include all materials, labor, tools, equipment, and incidentals necessary to complete the work connecting all segments of rail to one bridge.

When the use of guardrail on depressed medians is being planned to shield bridge piers, the designer should also consider the use of a Special Design Impact Attenuator Bull Nose Barrier. This design has been used for several years with excellent performance. The design utilizes a 5 foot radius W-beam guardrail and wooden breakaway posts; therefore, a 10 foot wide median would be the minimum. A similar design of the "Bull Nose Barrier" is shown in the AASHTO Roadside Design Guide. (Pay Item - Bull Nose Barrier-Each - Computer Est. No. 13601.) Installation layout details will be furnished by the Engineering Services Section for each Bull Nose Barrier location for inclusion in the plans. Bull nose barriers must not be used behind or on top of curbs or raised medians.

## SECONDARY PROJECTS

See Section A-1-Geometric Standards, GS-3, GS-4, GS-7 and GS-8 for additional widths to be added to the normal shoulders on secondary roads when guardrail is required.

## SAFETY/MAINTENANCE PROJECTS

When developing details for a Safety or Maintenance project, care must be taken to ensure proper barrier installation/maintenance/replacement to upgrade any outdated locations. There may be locations on a project where the guardrail has not been hit, but the installation may not be the safest that can currently be provided if an errant vehicle impacted the guardrail. Attention should be given to the following factors in evaluating these locations:

- (1) Location of barrier:
  - relative to hazard
  - relative to pavement
  - relative to shoulder break point
  - relative to fixed objects (such as bridges); face of guardrail should be aligned with bridge rail, not closer to the roadway

- (2) Type of guardrail used (Strong Post or Weak Post):
  - no longer use Weak Post guardrail adjacent to curb
  - cable guardrail normally used only on Limited Access facility with recoverable area exceeding 14 feet
  - sufficient space for maximum deflection for type used
  -
  
- (3) Terminals (need, type, proper installation, etc.):
  - end treatment needed on both ends of a run of barrier
  - terminals used with strong post guardrail
  - terminals used for run-on treatment with weak post guardrail
  - terminal treatment used as anchor for run-off end of weak post guardrail when not subject to two-way traffic
  - proper flare, anchor, post placement for terminal to effectively decrease damage caused to impacting vehicle
  - substandard terminals such as GR-5 (old turndown terminal), old standard GR-7 (those with 2' diameter concrete footings for first two posts), etc., should be replaced with approved terminals.
  - at bridges/walls, guardrail terminals should not be located closer to the roadway than the bridge rail or wall (fixed object attachment should be installed instead of separate units)
  
- (4) Shoulder width and site preparation:
  - provide sufficient width for site preparation
  - provide additional fill if necessary for proper flare installation
  - provide clear run-out area behind terminal installation
  
- (5) Fixed object attachments:
  - proper attachments to fixed objects (such as bridges/walls) to reduce possibility of snagging vehicles that impact the attachment
  - align guardrail with face of bridge rail so that the end of the bridge with the fixed object attachment will not become an additional hazard
  - include proper transition to gradually stiffen the overall approach

## **SECTION A-4-GUIDELINES FOR RRR PROJECTS**

### **OBJECTIVE**

The objective of the Virginia RRR Guidelines is to provide guidelines in the selection of projects where, with minimal improvements, the service life of the existing highway can be extended for a fraction of the cost of complete reconstruction.

Resurfacing, restoration, and rehabilitation (RRR) projects primarily involve work on an existing roadway surface and/or subsurface. In addition to extending the service life of the roadway, the purpose of RRR projects includes providing additional pavement strength, restoring or improving the existing cross section, decreasing noise characteristics, improving the ride of the roadway, improving bridges, and enhancing safety through the implementation of appropriate safety improvements, bridge improvements and preventive maintenance of bridges on appropriate Federal-aid roadways. Highway Bridge Replacement and Rehabilitation Program (HBRRP) Funds may be utilized for preventative maintenance (PM) for the purpose of system preservation activities on Federal-aid roadways except for those classified as local roads or rural minor collectors. Routine maintenance remains the responsibility of VDOT and/or locality.

Section 309 of the National Highway System Designation Act of 1995 (23 USC 116) states: "A preventive maintenance activity shall be eligible for Federal assistance under this title if the State demonstrates through the use of a systematic process, such as a Bridge Management System, to the satisfaction of the Secretary that the activity is a cost-effective means of extending the useful life of a Federal-aid highway."

The scope of a RRR project is influenced by many factors. Factors include roadside conditions, environmental concerns, changing traffic and land use patterns, surface deterioration rate, accident rates, funding constraints and scenic/historic areas.

Although RRR type improvements are normally accomplished within the existing right of way, the acquisition of additional right of way may be necessary. Horizontal and vertical alignment modifications, when required, are generally minor.

### **AUTHORITY**

The Transportation Research Board's Special Report 214, Designing Safer Roads, Practices for Resurfacing, Restoration, and Rehabilitation, 1987, was the result of a study on safety cost-effectiveness of highway geometric design standards for RRR projects. Virginia has developed and adopted this guideline for non-NHS RRR projects.

In the planning and design of any Secondary System improvements in rural areas, Virginia's RRR Guidelines shall be utilized to the extent possible.



On secondary projects that have a 15 year traffic projection of 750 vehicles per day or less, the RRR guidelines shall be the design concept of choice. Reconstruction under AASHTO design guidelines should be proposed on these projects only when the preliminary study report documents either:

1. The needed improvement is ineligible for development under the RRR concept.  
or
2. Extenuating circumstances preclude the use of the RRR Design concept.

Virginia RRR Guidelines may be utilized in improvements to urban streets **for which the localities receive maintenance payments.**

## **DEFINITIONS**

These definitions apply to RRR projects and are not an attempt to be all-inclusive of other related activities.

Maintenance - This work is directed toward preservation of the existing roadway and related appurtenances as necessary for safe and efficient operation. Design improvements are not normally the intent of maintenance operations. Seal coats, overlays less than 0.06 foot thick, crack sealing, etc., are considered maintenance items, and are not RRR activities.

Resurfacing - The addition of a layer, or layers, of paving material to provide additional structural integrity or improved serviceability and rideability.

Restoration - Work performed on pavement, or bridge decks, to render them suitable for an additional stage of construction. This may include supplementing the existing roadway by increasing surfacing and paving courses to provide structural capability, and widening up to a total of ten feet. Restoration will generally be performed within the existing right of way.

Rehabilitation - Similar to "Restoration", except the work may include restoring structural integrity or correcting major safety defects of bridges, reworking or strengthening the base or subbase, recycling or reworking existing materials to improve their structural integrity, adding underdrains, improving or widening shoulders, and shifts in both vertical and horizontal alignment involving less than 50 percent of the project length. Rehabilitation may require acquisition of additional right of way.

Reconstruction - This type of project is not considered RRR activity. A reconstruction project is designed in accordance with AASHTO design guidelines for new and major reconstruction projects and may include significant changes in cross section and shifts in both vertical and horizontal alignment. If 50 percent or more of the alignment changes, the project will be considered reconstruction. Reconstruction may require acquisition of additional right of way and may include all items of work usually associated with new construction.

## PROJECT SELECTION

Projects are identified and selected based on a variety of factors with the pavement condition being of utmost importance. The pavement condition itself will not have a significant effect on the extent of geometric improvements included in the project. Geometric improvements will be initiated to fulfill traffic service/safety needs.

Logical project termini are to be set; and, at no time, are project exceptions for segments of roadway or bridge, etc., to be established within the project termini due to excessive cost to provide the required improvements.

## ELIGIBILITY

Improvements to Existing Roadway:

### Eligible Items of Work \*

- Minor alterations to vertical and/or horizontal alignment.
  - Minor lane and/or shoulder widening.
  - Pavement structure and joint repair.
  - Resurfacing (non-maintenance activities).
  - Removal or protection of roadside obstacles.
  - Repairs to restore bridge structural integrity, installation of deck protective systems and upgrading substandard bridge rail.
  - Culvert Extensions.
  - **Repair or replace culverts.**
  - Restoration & relocation of curbs and gutters, raised medians, storm sewers, and other urban type improvements..
- Some RRR-type projects may be funded with either regular Federal-aid or separate categorical aid.

Examples:

Bridge rehabilitation project - RRR funding or the bridge replacement and rehabilitation program.

Roadside hazard removal and guardrail installation - RRR funding or hazard elimination program funds.

Ineligible Items of Work

- Projects in the National Highway System (NHS).
- New or additional through lanes.
- **New** Curbs and gutters, raised medians, storm sewers, and other **new** urban type improvements

**ACCIDENT RECORDS**

Evaluation of accident records often reveals problems requiring special attention. In addition, relative accident rates can be an important factor in establishing both the priority and the scope of RRR projects.

The Residency Administrator or Project Manager must request from the Traffic Engineering Division that the accident history for the project area be compiled and compared to the statewide average accident rate for the same type of road. This data review can be an integral part of the RRR project development process so that feasible safety modifications can be incorporated into the project as necessary.

The accident analysis shall be completed prior to the project field inspection/review and available for field review by the Federal Highway Administration.

**BRIDGE REHABILITATION OR REPLACEMENT SELECTION POLICY**

Existing bridges shall be evaluated and the necessary work shall be determined in accordance with the following provisions:

Bridges with overall deck area exceeding 20,000 square feet shall be evaluated and any necessary work shall be determined by the Structure and Bridge Engineer on a case-by-case basis.

All other bridges shall be replaced, rehabilitated, or allowed to remain in existing condition in accordance with the following:

- (1) Bridges shall be replaced under any one or more of the following conditions unless otherwise approved by the Structure and Bridge Engineer. The new replacement structure shall meet the current requirements of the Virginia Department of Transportation's Road and Bridge Standards. RRR guidelines may only be used for the total replacement of a bridge when the 15-year traffic projection is 750 vehicles per day or less.
  - a. If the estimated cost for rehabilitating the existing structure exceeds 65% of the estimated cost of a new structure.
  - b. If the existing or rehabilitated structure is overstressed under the loading specified in the AASHTO Manual for Maintenance Inspection of Bridges (i.e., if the bridge is to be posted for less than the legal load).
  - c. If the usable width of the existing or the rehabilitated bridge will be less than the minimum acceptable values for usable width of bridges on RRR projects shown in the table below, and it is not economically feasible to provide that width.
  
- (2) Bridges shall be rehabilitated as required or remain in the existing condition, if conditions in A, B, or C above do not prevail. The usable width of the existing or the rehabilitated bridge shall meet or exceed the minimum acceptable values for usable width of bridges on RRR projects shown in the Table hereinafter.

## MINIMUM BRIDGE WIDTHS ON RRR PROJECTS

SHALL BE AS FOLLOWS:

DESIGN YEAR VOLUME ADT	* USABLE BRIDGE WIDTH (FACE-TO-FACE OF CURB) FT.
0 - 750	WIDTH OF APPROACH LANES
751 - 2000	WIDTH OF APPROACH LANES + 2 FT
2001 - 4000	WIDTH OF APPROACH LANES + 4 FT
OVER 4000	WIDTH OF APPROACH LANES + 6 FT

NOTE: See [DRAINAGE DESIGN ELEMENTS](#) Bridge Restoration and Bridge Rehabilitation for hydraulic conditions that are to be evaluated.

- \* If lane widening is planned as part of the RRR project, the usable bridge width should be compared with the planned width of the approaches after they are widened.

### ENVIRONMENTAL CONSIDERATIONS

An environmental evaluation and documentation thereof, is required on all RRR Federal participation projects in accordance with current guidelines.

Prints are transmitted to the Environmental Engineer via Form LD-252.

### ACCESS CONTROL

Generally, a RRR project will not be designated as a [limited access](#) highway due to the project being along an existing corridor with access provided to adjoining properties.

The elimination of existing access to properties is beyond the scope of work for RRR projects.

Existing limited access roadways may qualify as a RRR project.

## PROJECT DEVELOPMENT

It is desirable that these projects be designed to meet the standards for new construction. If meeting these standards is not practical, due to limited funding, right of way and/or environmental restrictions, etc., improvements in roadway widths should still be considered.

The minimum roadway and travelway widths are shown under GEOMETRIC DESIGN CRITERIA, TABLE A-4-1. Lane and shoulder width requirements are provided for roadways with 10% or more trucks and for roadways with less than 10% trucks.

The design should not decrease the existing geometrics. Widths selected should be consistent throughout a given section. Minor lane and shoulder widening is acceptable. While additional new continuous traffic lanes are an ineligible type of work, the existing pavement may be widened up to a total of ten feet.

## ROADWAY AND TRAVELWAY WIDTHS

Wide lanes and shoulders provide motorists with increased separation between overtaking and meeting vehicles and an opportunity for safe recovery of vehicles leaving the road.

Additional safety benefits include reduced interruption of the traffic flow as the result of emergency stopping and road maintenance activities, less pavement and shoulder damage at the lane edge, and improved sight distance for horizontal curves.

## FUNCTIONAL CLASSIFICATION

The highway system in Virginia has been functionally classified as Principal Arterial, Minor Arterial, Collector and Local Service. The American Association of State Highway and Transportation Officials (AASHTO) utilizes, as presented in the publication: A Policy on Geometric Design of Highways and Streets, referred to as The AASHTO Book, a similar functional classification system. The designations used are: Freeway, Arterial, Collector, and Local Roads and Streets. Relationships between these two classification systems have been generally developed.

Principal and Minor Arterial Highways provide direct service between cities and larger towns and are high speed, high volume facilities. Collector highways serve small towns directly, connecting them and local roads to the arterial system.

## DESIGN TRAFFIC VOLUMES

Traffic projections should be checked to assure that:

The anticipated traffic being used is correct and that the roadway and travelway needs will be properly accommodated for the service life of the improvement.

The project service life for RRR projects should be from 8 to 12 years.

Turning movements are obtained at signalized and problem intersections and at major traffic generators.

Future traffic generators that are anticipated to be established during the service life should be considered.

## DESIGN SPEED

The design speed designated for a RRR project should be logical with respect to the character of terrain and type of highway and should be as high as practicable.

It is also important to consider the geometric conditions of adjacent sections of roadway when considering a RRR project. A uniform design speed should be maintained for a significant section of highway.

The design speed is a determining factor for required lane and shoulder widths. The following two methods may be used to determine the project design speed:

- (1) Select an overall project design speed that equals or exceeds the posted or regulatory speed on the section of highway being improved.
- (2) The average running speed throughout the project based on the "low volume" off peak hour traffic.

Average running speed is the speed of a vehicle over a specified section of highway, being the distance traveled divided by the running time (the time the vehicle is in motion).

An equivalent average running speed can be obtained on an existing facility where flow is reasonably continuous by measuring the spot speed.

The average spot speed is the arithmetic mean of the speeds of all traffic at a specified point.

For short sections of highway on which speed characteristics do not vary materially, the average spot speed may be considered as being representative of the average running speed.

On longer stretches of rural highway, spot speeds measured at several points, where each represents the speed characteristics pertinent to a selected segment of highway, may be averaged (taking relative lengths into account) to represent the average running speed.

## **TERRAIN**

Terrain is a significant factor which must be given strong consideration when establishing design criteria for a highway project. High design speeds (50 MPH and greater) can generally be achieved on flat terrain, and lower design speeds (40 MPH and lower) are generally dictated by rolling and mountainous terrain, (depending upon road classification). Intermediate design speeds are determined by a combination of these factors.

While terrain is an important factor to be considered when designing a new project, RRR projects must be designed considering all existing constraints, and held within RRR parameters. That is to say that eligible RRR elements, due to terrain and other constraints upon the original design, may not allow the desired speed and safety enhancements.

## **SAFETY**

All safety elements of the project are to be given specific consideration. Accidents, accident types, and accident rates for the project length shall be examined and documented.

The documentation may indicate deficiencies in one or more of the following areas, however, each should be examined:

- Horizontal and vertical alignment
- Cross-sectional geometrics
- Traffic control
- Access
- Railroad crossings
- Pedestrian facilities
- Bridges that remain in place
- Illumination
- Signing
- Channelization
- Intersections
- Pavement edge drop offs
- Pavement surface condition
- Maintenance of traffic
- Bicycle facilities



Improvements to the roadway surface may result in increased operating speeds. Geometrics should be examined and modified, if necessary, to maintain an acceptable level of operational safety.

Horizontal and vertical curvature and stopping sight distance are directly related to the speed of vehicles and major deviations from the desirable design may cause serious problems. These geometric characteristics can be the most difficult and costly to improve. Although every sight distance restriction can create a potential hazard, improvement on that basis alone may not be practical on every RRR project.

If curvature is shown to be the cause of numerous accidents, some corrective action should be taken. This corrective action can range from some form of positive guidance, which may include placement of additional warning signs and markings, to reconstruction.

Alignment improvements should be undertaken when accident experience is high, and if previously installed warning signs, markings, or other devices have not proven effective. In many cases, under both rural and urban conditions, existing horizontal and vertical alignments may be retained if a careful analysis indicates they can be adequately signed and marked.

If the calculated design speed for a particular horizontal or vertical curve is within 15 MPH of the design speed of the adjacent sections and the location is not an identified high accident location, (facilities with ADT < 750 vehicles per day), proper signs and markings informing drivers of the condition may be used in lieu of reconstruction to meet standards for the assumed design speed. When the difference is over 15 MPH or the design speed of the horizontal or vertical curve is less than 20 MPH, (facilities with ADT > 750 vehicles per day), corrective action must be considered and should be undertaken unless cost or other factors make the improvement impractical. If improvement is not possible, appropriate signs, markings and other provisions should be used to provide for proper speed transition.

Sight distance on horizontal curves, and at intersections, can often be improved by minor cut slope flattening, selective clearing or both. If such work is done, the actual sight distance must be measured, the maximum safe speed determined, and the location signed and marked accordingly.

Grades generally do not need to be flattened on RRR projects. Steep grades and restricted horizontal or vertical curvature in combination, however, may warrant corrective action.

A completed roadside hazard review is required. This will provide information regarding areas of potential concern relating to safety.

For safety, it is desirable to provide a roadside recovery area that is as wide as practical, but because of existing topographic features and right of way limitations associated with RRR work, considerable judgment must be used. The clear zone must be given particular attention at identified high roadside accident locations (fixed object and run-off-the-road accidents). An evaluation should be made to determine the consistency of the clear zone throughout the project limits.

Widening to provide more clear distance through short sections of rock cuts should be considered. In longer rock cuts, protrusions should be cut back or shielded if warranted. A review of accident data will help to define dangerous obstructions. Good engineering judgment, cost effectiveness, and consideration of community impact may also influence decisions.

Under urban conditions the minimum setback for any obstructions should be as close to the right of way line as possible or 1.5 feet behind the curb. Where sidewalks are to be included, it is desirable to locate all obstructions behind the sidewalk.

Safety items for reducing the severity of run-off-the-road accidents include traffic barriers (including bridge rails), flattening slopes to eliminate the need for either existing barrier or contemplated barrier placement, crash cushions, breakaway or yielding sign supports, and breakaway luminaire supports.

The priority for action relative to roadside hazards is to:

- Remove or redesign
- Relocate
- Make breakaway
- Redirect by using appropriate barrier
- Delineate

To enhance safety, all RRR projects should provide the following:

Evaluation of existing traffic barrier and end treatments to determine whether they are necessary and meet applicable guidelines and standards. The extent to which the barrier must be upgraded should be consistent.

Appropriate transition and connection of approach rail to bridge rail.

Mitered end sections for both parallel and cross-drain structures located in the clear zone.

Relocating, shielding, or providing breakaway features for sign supports and luminaires.

Protection for exposed bridge piers and abutments.

Drop inlets with traversable grates that are not a hazard to be used within the clear zone.

## GEOMETRIC DESIGN CRITERIA

The design criteria in Table A-4-1 for Minor Arterial, Collector and Local Road projects are based on the general approach in the "AASHTO Book" regarding functional classification and corresponding appropriate design volumes and also recommendations presented in TRB special Report 214, Practices for Resurfacing, Restoration, and Rehabilitation.

MINIMUM LANE AND SHOULDER WIDTH VALUES								
ARTERIAL/ COLLECTOR/ LOCAL ROAD AND STREET SYSTEMS								
DESIGN TRAFFIC VOLUME	DESIGN SPEED MPH	10% OR MORE TRUCKS (d)			LESS THAN 10% TRUCKS (d)			DITCH WIDTH 3:1 SLOPE
		LANE WIDTH		SHOULDER WIDTH (c)	LANE WIDTH		SHOULDER WIDTH (c)	
ADT		C&G	W/SHLD			C&G		W/SHLD
(a)	(b)	(FT.)	(FT.)	(FT.)	(FT.)	(FT.)	(FT.)	(FT.)
1 - 750	< 50	11 (e)	10 (e)	2 (i)	10	9	2 (i)	3 (h)
	≥ 50	11	10	2 (i)	11	10	2 (i)	3 (h)
751 - 2000	< 50	11	11 (f)	2 (l)	11	10	2 (l)	3
	≥ 50	12	12 (g)	3 (i)	11	11	3 (i)	3
2001 - 4000	ALL	12	12	6	11	12	6	4
4001 - OVER	ALL	12	12	6	12	12	6	4

## GEOMETRIC DESIGN CRITERIA

**TABLE A-4-1**

- (a) Design traffic volume is between 8 and 12 years from completion.
- (b) Highway segments should be classified as "Under 50" only if most vehicles have an average running speed of less than 50 MPH over the length of the segment.
- (c) Cut shoulder width may be reduced by one foot in mountainous terrain.
- (d) Trucks are defined as heavy vehicles with six or more tires.
- (e) Use 9' lane width for Rural/Local Road System with ADT of 1 - 250.  
(9' lane width is equal to new construction standards for Rural/Local Road System)  
Use 10' lane width with Curb and Gutter for Urban with ADT 1-250  
(10' lane width is equal to new construction standards)
- (f) Use 10' lane width for Collector Road and Local Road System in mountainous terrain. (10' lane width is equal to new construction standards.)
- (g) Use 11' lane width for Collector Road and Local Road System in level terrain. (11' lane width is equal to new construction standards.)
- (h) Use 2' ditch width with pavement depths (excluding cement stabilized courses) of 8" and less.
- (i) Minimum width of 4' if roadside barrier is utilized (minimum 2' from edge of pavement to face of G.R.).

NOTE: PAVEMENT AND SHOULDER WIDTHS NOTED ARE MINIMUMS FROM A DESIGN CRITERIA STANDPOINT. UNDER NO CIRCUMSTANCES SHALL THE EXISTING PAVEMENT OR SHOULDER WIDTHS BE REDUCED TO CONFORM TO THESE MINIMUM STANDARDS.

NOTE: FOR VALUES NOT SHOWN, SEE APPROPRIATE GEOMETRIC DESIGN STANDARD FOR THE FUNCTIONAL CLASSIFICATION OF ROADWAY (GS-2, GS-3 OR GS-4) CONTAINED IN THE VDOT ROAD DESIGN MANUAL, APPENDIX A, SECTION A-1.

NOTE: ROADSIDE HAZARDS AND PRIORITY FOR RELATIVE ACTION ARE COVERED ON PAGE A-29.

## **CLEAR ZONES AND SLOPES**

Wherever possible, existing side slopes should not be steepened when widening lanes and shoulders. When the initial slopes are relatively flat, however, the slope can be steepened to 6:1 with little effect, and steepening to 4:1 may be reasonable.

Consideration should be given to flattening side slopes of 3:1 or steeper at locations where run-off-the-road type accidents are likely to occur (e.g. on the outsides of horizontal curves). Accident data should be used (when available) to substantiate run-off-the-road accident locations.

Removing, relocating or shielding of isolated roadside obstacles should be evaluated in accordance with the Clear Zone and Traffic Barrier Guidelines contained in the Road Design Manual, Appendix A, Sections A-2 and A-3.

## **GRADES**

Grades generally do not need to be flattened on RRR projects. Steep grades and restricted horizontal or vertical curvature in combination, however, may warrant corrective action.

## **CREST VERTICAL CURVES**

An existing vertical curve may be retained as is, without further evaluation, if the existing design speed provides the stopping sight distance within 15 MPH of the overall project design speed and the average daily traffic volume is less than 750 vehicles per day.

Reconstruction of crest vertical curves is to be evaluated when the above speed and traffic volumes are exceeded and the vertical curve hides major hazards from view. Major hazards include, but are not limited to intersections or entrances, sharp horizontal curves and narrow bridges.

## SAG VERTICAL CURVES

Substandard sag vertical curves should be investigated to ensure that potential hazards do not exist, especially ones that become apparent when weather conditions, or darkness, reduces visibility.

## STOPPING SIGHT DISTANCES

Guidelines for determining the existing sight distances of vertical and horizontal curves are as follows:

- Existing road data to be determined from survey plan and profile sheets and/or old plans obtained from the plan library.

- Road and Bridge Standards [SD-1](#) and [SD-4](#) may be used to determine the sight distances using the following methods:

Vertical curves - Determine algebraic differences of grades in percent and length of vertical curve in feet from the survey plans, or old project plans, and the sight distance may be obtained from Standard [SD-4](#).

Horizontal curves - Determine the existing degree of curve and the middle ordinate or radial distance from centerline of inside lane to obstruction to view and the sight distance may be obtained from Standard [SD-1](#).

- Vertical and horizontal curve sight distances may be scaled from the plans using the following heights of driver's eye and object:

<u>Sight Distance</u>	<u>Height of Eye</u>	<u>Height of Object</u>
Stopping	3.5'	2'
Passing	3.5'	3.5'

## HORIZONTAL CURVES

An existing horizontal curve may be retained as is, without further evaluation, if the existing curve design speed, with correct superelevation provided, corresponds to a speed that is within 15 MPH of the running speeds of approaching vehicles and the average daily traffic volume is less than 750 vehicles per day.

Reconstruction of horizontal curves should be considered and evaluated when the above speed and/or volume criteria are exceeded.

When a roadway segment consists of a series of reverse curves or curves connected by short tangents, the succession of curves shall be analyzed as a unit rather than as individual curves.

The first substandard curve in a series should receive special attention because this change in alignment prepares the driver for the remaining curves in the series.

Any intermediate curve in a series of substandard curves that is significantly worse than the others in the series should be analyzed individually.

These controlling curves can be used to determine the safety and/or other mitigation measures to apply throughout the series.

### **PAVEMENT CROSS SLOPE**

Pavement resurfacing or rehabilitation will be accomplished such that the finished pavement on tangent sections will be crowned in accordance with new construction standards.

### **SUPERELEVATION REQUIREMENTS**

Standard superelevation will be provided on all curves to comply with the project design speed unless the following conditions exist:

- Excessive cost to provide superelevation.
- Excessive property damage.

Superelevations may be provided for design speeds up to a maximum of 15 MPH less than the project design speed for current traffic volumes of 750 vehicles per day or less, if the above conditions exist, with appropriate signing:

- Advisory curve signs and speed limit signs will be erected.

### **PAVEMENT EDGE DROP**

Pavement edge drops usually are caused by resurfacing of pavement without regrading the existing shoulder or erosion of gravel, turf, or earth shoulder materials.

This hazard shall be eliminated or mitigated by utilizing one or more of the following practices:

- Paving the full top width between shoulder breaks.

Selectively paving shoulders at points where vehicle encroachments are likely to create pavement edge drops, such as on the inside of horizontal curves.

Constructing a beveled or tapered pavement edge so that any edge drop that develops has a reduced impact on the recovery maneuver.

Reconstruction of shoulders.

## **INTERSECTIONS**

Many intersection improvements can be made at a relatively low cost and are safety cost-effective, particularly at higher traffic volumes.

The intersection improvements must be tailored to site-specific conditions and rely heavily on professional judgment and experience along with current Department guidelines.

## **DESIGN EXCEPTIONS**

All efforts should be made to adhere to the standards stated herein. However, under unusual conditions, it may be necessary to use values that are less than the minimum values shown. If lesser values are proposed for use, a justification report will be needed and approval by the State Location and Design Engineer and the Federal Highway Administration on Federal aid funded projects must be granted before developing the project further.

Methods of showing design exceptions on the plans are noted in Instructional and Informational Memorandum IIM-LD-227. Design Exceptions are to be requested on Form LD-440, maintained on the VDOT website at <http://www.extranet.vdot.state.va.us/forms/>. If approved, the completed Form LD-440 is to be attached to Form LD-430 Scoping Report for submittal at advertisement stage.

## **PLANNING DRAINAGE DESIGN ELEMENTS**

The hydraulic consequences of a highway improvement need to be addressed during the planning phase of the project.

Failure to assess the hydraulic aspects of the improvement could result in an increase in damages to adjacent property as well as the highway facility. Although detailed site information may not be required, it is important that a hydraulic assessment be made by a drainage engineer in the planning phase to determine that engineering and regulatory constraints can be met.

Items to be considered include:

- Hydraulic impacts
- Interaction with other agencies
- Utilities
- R/W and property owners' concerns
- Environmental concerns and permits.

## **REPLACEMENT OR REHABILITATION OF DRAINAGE ELEMENTS**

The decision to rehabilitate or replace a structure should not be made without checking hydraulic adequacy. Normally, the highway designs that improve upstream flooding conditions should generally result from meeting highway flooding criteria. Scour protection, spur dikes, or other protective measures should be included with the bridge rehabilitation.

The decision regarding the rehabilitation or replacement of existing bridges or culverts is often a structural or functional decision. Hydraulic input is important when the cost of the rehabilitation is high enough to consider replacement or where the contemplated rehabilitation involves a change in the roadway profile which, by lessening roadway overflow, could increase hydraulic stresses on the structure and change flow distribution.

Rehabilitation or replacement of culverts often becomes necessary when the culvert is no longer structurally sound. Consideration of the remaining service life of the existing culvert is, therefore, a very important factor in deciding to rehabilitate or to replace it.

In some instances, structures may require replacement due to inadequate waterway area and subsequent frequent interruption of traffic due to flooding. Prolonged ponding behind an embankment caused by an inadequate culvert may also lead to embankment saturation or piping along the culvert.

## **HYDRAULIC CHARACTERISTICS**

The hydraulic considerations for RRR improvement projects are, in many respects, the same as those for a highway on new alignment. The primary difference is that the hydraulic characteristics of the existing facility are already established. These hydraulic characteristics include:



- Culvert performance (inlet or outlet control or headwater at culvert sites).
- Culvert outlet velocities and scour tendencies.
- Flow lines and culvert alignment.
- Backwater at bridge sites.
- Flow distribution.
- Scour patterns at bridge piers, bridge abutments and adjacent banks.
- Skew and channel alignment.
- Storm drain systems and their performance.

The engineer must consider the need for changing and the consequences of changes to these hydraulic characteristics.

Most improvement projects will require some modification of the existing drainage structures. If the hydraulic performance of a drainage structure is changed, the change should be investigated for both upstream and downstream effects of the change.

Because the hydraulic effects of existing structures are usually well established, there is sometimes opposition to change from the landowner(s) affected. This is particularly true in developed areas.

Debris conditions may be changed and should be considered in design. Roadside ditch drainage patterns may be altered. These conditions should be thoroughly studied before any change is allowed.

## **SAFETY IMPROVEMENTS RELATIVE TO DRAINAGE DESIGN**

Where the hazard is a culvert headwall, the options usually are to extend the culvert, protect traffic with guardrail, or construct a protective grate over the headwall. The alternative selected should be based on particular site conditions. Grates on cross culverts with the potential to collect significant debris are undesirable because of the potential hazard created for local flooding. A good way to evaluate the risk is to assume the grate will be plugged and then determine what flood hazard will be created. In all cases, it is very important that grates on culvert end be inspected frequently and always cleared of debris. Spaces between grate bars should be as large as practicable in order to lessen the probability of plugging.

The wide openings tend to minimize the flood hazard by reducing the potential of debris plugging the culvert.

## **BRIDGE RESTORATION**

Hydraulically Equivalent Replacement Structure (HERS) definition:

The waterway opening of the proposed structure provides the same height, width obstructions (piers) and geometric configuration as the existing structure.

The proposed roadway grades on the approaches and the structure provide the same overtopping characteristics as the existing facility.

Any of the above characteristics of the proposed facility are less restrictive to the passage of flood flows than are the characteristics of the existing facility.

Every waterway crossing whose 1% exceedance probability discharge is anticipated, estimated or expected to be 500 cfs or greater **MUST** be reviewed by an appropriate river mechanics specialist. When the proposed facility is determined to be the hydraulic equivalent of the existing facility, no formal design analysis will be required.

If a rehabilitation of the structure and/or its approach roadway does not conform to the HERS requirements, it must be treated as a bridge replacement, and an engineering analysis is required.

## **BRIDGE REHABILITATION**

Bridge repairs are often required because of structural deterioration, damage from floods, and damage from vehicles. Bridge rehabilitation consists of physical changes to a bridge which are necessary because of inadequate width, structural capacity, hydraulic capacity, or because of scour or degradation.

Where bridge repair or rehabilitation is being considered, the cost of the repair should be compared with the cost of complete replacement. (see BRIDGE REHABILITATION OR REPLACEMENT SELECTION POLICY on page A-42). The hydraulic requirements of the bridge should also be reviewed when extensive repair or rehabilitation is being contemplated. This hydraulic review is particularly important if a change in the roadway profile is to be included in the rehabilitation.

In some cases, the grade may be raised so that roadway overflow is eliminated without changing the bridge size. This can be a deliberate change of the grade or a slow change, such as maintenance forces placing asphalt overlays on the grade over a period of years. These changes should always be reviewed by the hydraulics design section for effect on flow distribution, on backwater, and on velocity through the bridges.

A replacement bridge may have a deeper superstructure and solid rails. These differences will affect a stream crossing unless compensating adjustments are made in the profile gradeline.

Where the profile grade is raised, the effect may be to eliminate or lessen roadway overflow which could force more water to flow through the bridge opening. Solid rails can have the same effect. If the grade is lowered, the flow pattern and the amount of flow directed over the road and into downstream property could be increased.

When replacement bridges have shorter spans than the existing bridge, the resulting increase in the number of piers could add a debris and scour problems or increase backwater.

## **CULVERT REPLACEMENT**

When an existing culvert is to be replaced, an analysis should be made to see if the size of the existing culvert is either smaller or larger than necessary.

## **CULVERT REHABILITATION**

A properly installed culvert generally loses its structural integrity through corrosion and/or abrasion of its invert, although overall loss of material in the pipe wall can occur some installations due to the corrosive action of the backfill material or the water flowing through the culvert. Common restoration techniques include:

Provision for replacement of the culvert invert.

Threading of a smaller size culvert or liner plate through the original culvert and grouting of the voids between the two culverts.

Use of commercial products for relining pipe with epoxy-coated fabric materials.

Any proposed culvert rehabilitation scheme should be analyzed for hydraulic adequacy and outlet protection. Normally, the smaller cross sectional area resulting from culvert rehabilitation will lead to higher headwater elevation; however, this effect may be insignificant if there is storage upstream or if the potential for damage is minimal. Another consequence of a reduction in pipe size may be higher outlet velocities. This factor should also be assessed during the design of a culvert rehabilitation project.

Use of smooth linings, improved inlets, etc. may also improve the hydraulic performance of the relined culvert and essentially offset the loss of cross sectional area.

Many older culverts were built during a period when less attention was given to the need for accommodating fish passage. Such accommodations can often be incorporated by the addition of baffles in the culvert barrel; however, such designs should be checked to ensure that the revised design is hydraulically adequate.

## **CULVERT EXTENSIONS**

The extension of an existing culvert can result in significant changes to the hydraulic performance. Extending the inlet of a culvert operating in inlet control establishes a higher inlet flow line, which will raise the inlet headwater elevation an equal amount. Extending a culvert which operates under outlet control may also increase the headwater because of head losses associated with the longer barrel.

Culvert extensions can cause the approach or the exit flow alignment to be unacceptable. This can usually be corrected by either extending the culvert on a skew angle that will fit the channel alignment or modifying the channel.

Long culvert extensions could cause the culvert to switch from inlet control to barrel (outlet) control, which will result in an increase in headwater.

In addition to the above noted changes, a long culvert extension may also create problems with fish passage through the culvert that should be addressed during the design.

## **SIGNING, SIGNALS AND PAVEMENT MARKINGS**

Traffic control devices such as signing, signals, and pavement markings must be updated in accordance with the Manual on Uniform Traffic Control Devices and the VDOT's Road and Bridge Standards.

While traffic control devices cannot fully mitigate all problems associated with substandard geometric features, they are a relatively low cost measure that can compensate for certain operational deficiencies.

Where roadway geometry or other roadway or roadside features are less than standard, do not meet the driver's expectancy, and reconstruction is not feasible, additional signs, markings, delineation and other devices beyond normal requirements of the MUTCD should be considered.

Judicious use of special traffic regulations, positive guidance techniques, and traffic operational improvements can often forestall expensive reconstruction by minimizing or eliminating adverse safety and operational features on or along existing highways.

Signals are to be provided at warranted locations.

## **PLAN REVIEWS**

Preliminary Plan Reviews and Field Inspections are to be held in accordance with the standard procedures. The Federal Highway Administration (FHWA) is to be notified of each and invited to attend.

## **PUBLIC INVOLVEMENT**

RRR projects are to be developed utilizing the Department's Public Involvement Policy to keep the public sufficiently informed and involved as the project progresses so that a formal public hearing can be eliminated in most, if not all, cases.

## **RIGHT OF WAY**

Although RRR type improvements are normally made within the existing right of way, additional right of way may be required to provide the necessary improvements.

Any required right of way and/or easements will normally be secured by donation. However, right of way may be acquired.

All right of way negotiations are to be conducted in accordance with the applicable statutes, regulations, policies, and procedures stipulated in the Right of Way and Utilities Division's Manual of Instructions and related memoranda.

## **UTILITIES (UNDERGROUND AND OVERHEAD)**

Where utilities are involved on RRR projects, the Department's General Guidelines for Accommodating Utilities Within Highway Right of way are to be followed.

Relocation or adjustment may be required if the minimum clear zone requirements are not met or if the utility system conflicts with proposed RRR improvements and sufficient right of way is available. For Federally funded RRR projects, an exception request must be made if the project does not meet the minimum clear zone requirements.

In some cases, the utility system on RRR projects may be retained without adjustment or relocation if the accident history does not indicate the existence of a hazard or if the system has demonstrated adequate performance and does not conflict with proposed improvements.

## **TORT LIABILITY AND GEOMETRIC DESIGN**

In recent years highway agency administrations have become increasingly concerned about the growth of tort claims. Such claims allege that highway agencies have committed a legal wrong by improper or negligent highway design, operation, or maintenance that became a cause or partial cause of a highway accident. Claims against highway agencies are part of a nationwide problem of rising liability insurance premiums and increasing costs of tort actions.

Studies indicate that the geometric design features covered in RRR standards are usually not the central focus of tort claims. Pavement features, traffic control devices, and roadside barriers account for the large majority of tort claims.

## **BACKGROUND ON TORT LIABILITY**

Tort is defined as a civil wrong or injury, and a tort action seeks repayment for damages to property and injuries to an individual. If a defendant is found negligent in his actions, or lack of action, he is liable for a tort claim and must compensate the plaintiff. State laws and rulings differ regarding tort claims against a governmental entity. In Virginia, as in most states, the courts or state legislatures have eliminated sovereign immunity (whereby an individual cannot sue the state or its agents for negligence).

Highway agencies are spending substantial sums as a result of tort claims. The costs of handling tort claims include not only the direct costs of judgment awards, settlements, and insurance, but also attorneys' fees and the cost of engineers' and other staff time.

Negligence can be alleged on two grounds particularly relevant to highway agencies:

- Agency (or person) improperly performs its duties (misfeasance).
- Agency (or person) fails to perform its duties (nonfeasance).

## **RRR IMPROVEMENTS AND TORT CLAIMS**

Little is known about how frequently the geometric features addressed by RRR design standards are cited in tort claims against highway agencies. Few states maintain data on tort claims by alleged defect. Further, classifying tort lawsuits is difficult because most involve several defects that differ in importance.

Geometric features (such as cross-sections, alignment, and intersections) usually covered by RRR standards account for a small percentage of total claims filed against highway agencies. Of the cases in which a geometric feature is at issue, horizontal and vertical curves are the most often cited.

Pavement features including edge drops, potholes, surface deterioration and slippery pavements, account for large amounts of the settlement costs.

## **SUSCEPTIBILITY OF RRR PROJECTS AND STANDARDS TO TORT CLAIMS**

The standards selected for RRR projects, the design process followed, and the scope of the improvements may influence the litigation of future tort claims. The issues that might arise in a tort action are:

- Did the project meet the appropriate design standards?
- Are the standards reasonable?
- Was the design process reasonable?
- Did the improvements correct existing dangers?

- Should unimproved roads be judged by standards used for roads that are unimproved?

The resolution of tort claims alleging an inadequate geometric design is contingent on determining the appropriate set of design standards used to assess negligence.

Determining whether a highway improvement project is sufficiently extensive to qualify as reconstruction can be a key issue in a tort claim because reconstruction projects usually must meet current new construction standards.

Deficient roadside signs or pavement markings and pavement edge-drop problems, which are often the basis of tort claims, can be routinely corrected on RRR projects.

## **DEFENSE OF A RRR PROJECT DESIGN**

Although planning and design activities are exempt from liability in most states, this immunity has been held not to apply to decisions made without prior study or conscious deliberation.

Documentation of the planning process should be part of the state highway agency's defense.

For RRR projects, documentation should demonstrate that safety aspects of the roadway design were properly considered. Reports that identify deficiencies in existing roadways are potentially threatening to the public agency preparing the report if the deficiencies are not addressed. Thus, if any exception to an applicable design standard was granted, documentation should explain the reasons for the exception and show that logic and orderly procedures were followed in obtaining it.

When a highway agency contemplates a design exception for a geometric or roadside feature, it should be prepared to prove why the feature need not meet the same standards as other facets of the roadway design. Often, the best defense in this situation is to demonstrate that the safety cost-effectiveness of further upgrading the feature does not meet any reasonable criteria.

Courts seldom rule that the unavailability of funds is justification for not correcting an alleged defect, but the issue of availability of funds can be part of the defense in relation to the agency's programming procedures.

The following points are important to such a defense:

- The agency is aware of the condition of its facilities
- Deficiencies have been ranked on a logical basis
- Given the existing funding, items are being corrected in the order of priority

Appropriate warnings or other temporary measures should be used to alert the public that deficiencies have not been corrected. The highway agency can then affirm that it has performed its duties in the best way possible with the available resources.

In order to receive immunity for planning and design activities, a state must thoroughly document the design process in order to defend challenges.

A rational and orderly process must be followed if a plan or design is to be considered immune from claims of negligence. If a feature built during construction was not called for in the plans or was altered from the specifications, it is open to a claim of negligence in a tort action.

### **RRR NOTES ON PROJECT TITLE SHEET**

For applicable projects, the following note shall be placed on the plan [title sheet](#) under the Functional Classification and Traffic Data Block:

**NOTE: THESE PLANS WERE DESIGNED IN ACCORDANCE WITH VIRGINIA RRR GUIDELINES.**



## **SECTION A-5-BICYCLE FACILITY GUIDELINES**

### **INTRODUCTION**

These guidelines consist of six sections:

- A. INTRODUCTION
- B. DOT POLICY ON PARTICIPATION IN THE DEVELOPMENT OF BICYCLE FACILITIES
- C. SELECTING ROADWAY DESIGN TREATMENTS TO ACCOMMODATE BICYCLES; this report contains recommendations for bikeway design
- D. VDOT/AASHTO DESIGN GUIDELINES; these include bicycle path design guidelines and minimum bikeway design guidelines
- E. AASHTO APPROVED INTERSTATE BICYCLE ROUTES
- F. RESOURCES (followed by conversions from Imperial units to metric units)

The Transportation Planning Division will recommend to the road designer the inclusion of a bikeway on a particular project. Discussion will take place at the scoping meeting concerning the expected type of bicyclist that will use the facility and the type of facility to be designed. The district, locality, Transportation Planning Division and other interested parties will provide input. Types of bicyclist include Group A, advanced; Group B, basic; and Group C, children. AASHTO designates bicycle facility types as Shared Roadway (No Bikeway Designation), Signed Shared Roadway, Bike Lane or Bicycle Lane and Shared Use Path. Individuals involved in the planning and design of bicycle facilities should be familiar with and refer to the latest Guide for the Development of Bicycle Facilities published by the American Association of State Highway and Transportation Officials. At the printing of these VDOT guidelines the date of the AASHTO Guide was 1999.

In rural and some urban sections of highway with scattered development, it is recommended that the facility be designed for Group A bicyclists. In developed areas near parks, schools, recreation areas, etc., it is recommended that the facility be designed for Group B, C bicyclists. Separate bike paths are recommended in areas where bicyclists are expected to be children, pre-teen or casual recreation riders.

Guidelines in SELECTING ROADWAY DESIGN TREATMENTS TO ACCOMMODATE BICYCLES are recommended as bikeway design criteria, but in no case will a bikeway be designed with criteria less than those contained in the VDOT/AASHTO DESIGN GUIDELINES. Bicycle facility design guidelines are available only in the VDOT/AASHTO DESIGN GUIDELINES section. One set of pertinent plans, profiles and typical sections on appropriate projects are to be provided to the Location and Design Bicycle Facilities Coordinator prior to Preliminary Engineering, Field Inspection and after related comments are received at public information meetings.

The procedure for planning and designing a bicycle facility is:

1. Select the type of bicyclist; A, B or C or a combination of these.
2. Select the roadway design treatment or type of facility.
3. Design the facility in accordance with the VDOT Guidelines: FHWA and AASHTO

## **VDOT POLICY TO IMPROVE BICYCLE AND PEDESTRIAN ACCESS**

The Commonwealth Transportation Board (CTB) approved a new policy aimed at providing bicyclists and pedestrians greater access to safe transportation on roadways across the state. The policy became effect upon its adoption by the Board on March 18, 2004, and will apply to projects that reach the scoping phase after its adoption. This policy shall supersede all current department policies and procedures related to bicycle and pedestrian accommodations.

Highlights from the policy include:

- A framework through which VDOT will accommodate bicyclists and pedestrians, including pedestrians with disabilities, along with motorized transportation modes in the planning, funding, design, construction, operation, and maintenance of Virginia's transportation network to achieve a safe, effective, and balanced multimodal transportation system.
- Sidewalks, bike lanes, shared-use paths or other accommodations will be considered in the design of all new highway and major reconstruction projects, depending on safety issues and the need.

Project Managers should be familiar with the policy prior to starting the Project Development Process. The entire policy can be obtained at <http://www.virginiadot.org/infoservice/resources/Policy%20on%20Integrating%20BP%20Accommodations.pdf>

The following are a few excerpts from the policy:

The Virginia Department of Transportation (VDOT) will initiate all highway construction projects with the presumption that the projects shall accommodate bicycling and walking. VDOT will provide the leadership to implement this policy. During the decision process, the project manager and local representatives will, based on the factors listed in the policy, develop a recommendation on how and whether to accommodate bicyclists and pedestrians in a construction project prior to the public hearing. VDOT will promote the inclusion of bicycle and pedestrian accommodations in transportation planning activities at local, regional, and statewide levels. There are exceptions to the provision of accommodations.

Bicycle and pedestrian accommodations can be developed through projects that are independent of highway construction either within the highway right-of-way or on an independent right-of-way. Highway construction funds can be used to build bicycle and pedestrian accommodations either concurrently with highway construction projects or as independent transportation projects. Both types of bicycle and pedestrian accommodation projects will be funded in the same manner as other highway construction projects for each system (i.e., interstate, primary, secondary, or urban).

VDOT will work with localities to select and design accommodations, taking into consideration community needs, safety, and unique environmental and aesthetic characteristics as they relate to specific projects. The selection of the specific accommodations to be used for a project will be based on the application of appropriate planning design, and engineering principles. The accommodations will be designed and built, or installed, using guidance from VDOT and AASHTO publications, the MUTCD, and the Americans with Disabilities Act accessibility Guidelines (ADAAG). Methods for providing flexibility within safe design parameters, such as context sensitive solutions and design, will be considered.

During the preparations of an environmental impact statement (EIS), VDOT will consider the current and anticipated future use of the affected facilities by bicyclists and pedestrians, the potential impacts of the alternatives on bicycle and pedestrian travel, and proposed measures, if any, to avoid or reduce adverse impacts to the use of these facilities by bicyclists and pedestrians.

During project design VDOT will coordinate with the Virginia Department of Rail and Public Transportation (VDRPT) to address bicyclist and pedestrian access to existing and planned transit connections.

Requests for exceptions to design criteria must be submitted in accordance with VDOT's design exception review process. The approval of exceptions will be decided by the Federal Highway Administration or VDOT's Chief Engineer.

VDOT will ensure that accommodations for bicycling and walking are built in accordance with design plans and VDOT's construction standards and specifications.

## **BICYCLE ACCESS FACILITIES**

VDOT may participate in the development of bicycle access facilities to serve public recreational areas and historic sites based on the current Recreational Access Fund Policy.

## **EXISTING ROADS**

In some instances, for route continuity, bicycle facilities may be routed over existing facilities which are not planned for expansion. In these cases, the facilities are an operational feature and usually result in the identification of a bike lane, restriction of parking, or some other physical modification to accommodate bicycle travel. It is necessary for the Transportation Planning Engineer to coordinate with the District Administrator, the District Traffic Engineer, and appropriate Divisions in the Central Office to assure agreement on the method of treatment for a bikeway over an existing route. All the conditions of VDOT Bicycle Facility Participation Guidelines and VDOT Funding Guidelines need to be met except the bicycle facility is not required to be constructed concurrently with a highway construction project. VDOT's financial participation and funding will be the same as specified in VDOT Funding Guidelines.

## **MAJOR DEVELOPMENTS AND SITE PLANS**

When bicycle facilities are considered as part of the total development of a property where the road system will be maintained in the future by VDOT and the local government requires bikeways in new developments, the following conditions must be satisfied:

- The bicycle element of the entire plan for the development must be Reviewed and approved by the local government prior to final approval by the Transportation Planning Engineer. Appropriate Review must be made, and communication regarding the resolution of bicycle facility systems must be carried on between the Resident Engineer, District Traffic Engineer, and the Transportation Planning Engineer.
- Along any roadways identified in the site plan, which will be maintained in the future by VDOT, a bike path may be incorporated into the development parallel to but off of the right of way dedicated for street purposes. The maintenance and the responsibility for operating the bike path would fall on the owner, which would be the locality, the developer, or other entity with the responsibility of maintenance of the common land of the development and not the responsibility of VDOT. The bike path right of way will be exclusive of the road right of way; thus, future changes and/or modifications in the bike path would not be the responsibility of VDOT.
- Bikeways within the VDOT right of way shall be designed to meet AASHTO and VDOT guidelines.

For major developments and site plans where the road system will not be maintained in the future by VDOT, all bicycle facility connections to VDOT maintained facilities shall be subject to Review and approval by the District Administrator.

## **SELECTING ROADWAY DESIGN TREATMENTS TO ACCOMMODATE BICYCLES**

Choosing the appropriate facility type is important. No one type of bicycle facility or highway design suits every bicyclist. Within any given transportation corridor, bicyclists may be provided with more than one option to meet the travel and access needs of all potential users.

The choice of highway design will affect the level of use, the types of user that can be expected to use any given road, and the level of access and mobility that is afforded bicyclists. For example, a four-lane divided highway with 12-foot travel lanes, no shoulder and a 55 mph speed limit will attract only the most confident of riders. The same road with a 5-foot shoulder or bike lane might provide sufficient “comfortable operating space” for many more adult riders, but would still not be comfortable for children or less confident adults. This latter group might only be accommodated through an alternative route using neighborhood streets linked by short sections of shared use path. If such an alternative route is provided and the four-lane road has a continuous paved shoulder, most experienced and many casual adult riders will continue to use the shoulder for the sake of speed and convenience.

Facilities for bicyclists should also be planned to provide continuity and consistency for all users. Children using a path to get to school should not have to cross a major arterial without some intersection controls, and shoulders and bike lanes should not end abruptly and unannounced at a difficult intersection or busy stretch of highway.

The selection of a bicycle facility type is dependent on many factors, including the ability of the users, specific corridor conditions and facility cost. AASHTO designates bicycle facility types as Shared Roadway (No Bikeway Designation), Signed Shared Roadway, Bike Lane or Bicycle Lane and Shared Use Path. The following are explanations of when each of these facilities may be appropriate. Design parameters for these four types are discussed later in this publication.

- Shared Roadway (No Bikeway Designation) - Most bicycle travel in the United States now occurs on streets and highways without bikeway designations. In some instances, a community’s existing street system may be fully adequate for efficient bicycle travel and signing and striping for bicycle use may be unnecessary. In other cases, some streets and highways may be unsuitable for bicycle travel at present, and it would be inappropriate to encourage bicycle travel by designating the routes as bikeways. Finally, some routes may not be considered high bicycle demand corridors, and it would be inappropriate to designate them as bikeways regardless of roadway conditions (e.g., minor residential streets).
- Some rural highways are used by touring bicyclists for inner city and recreational travel. In most cases, such routes should only be designated as bikeways where there is a need for enhanced continuity with other bicycle routes. However, the development and maintenance of 4-foot paved shoulders with a 4-inch edge stripe can significantly improve the safety and convenience of bicyclists and motorists along such routes.

- Signed Shared Roadway - Signed-shared roadways are designated by bike route signs, and serve either to provide continuity to other bicycle facilities (usually Bike Lanes) or designate preferred routes through high-demand corridors.
- Bike Lane or Bicycle lane - Bike lanes are established with appropriate pavement markings and signing along streets in corridors where there is significant bicycle demand and where there are distinct needs that can be served by them. The purpose should be to improve conditions for bicyclists on the streets. Bike lanes are intended to delineate the right of way assigned to bicyclists and motorists and to provide for more predictable movements by each. Bike lanes also help to increase the total capacities of highways carrying mixed bicycle and motor vehicle traffic.
- Shared Use Path - Generally, shared use paths should be used to serve corridors not served by streets and highways or where wide utility or former railroad right-of-way exists, permitting such facilities to be constructed away from the influence of parallel streets. Shared use paths should offer opportunities not provided by the road system. They can provide a recreational opportunity or, in some instances, can serve as direct commute routes if cross flow by motor vehicles and pedestrians is minimized.

The tables in this section contain roadway design treatments and widths to accommodate bicycles found in the Federal Highway Administration Report "Selecting Roadway Design Treatments to Accommodate Bicycles", Publication Number FHWA-RD-92-073 January 1994. The controlling feature in the design of every bicycle facility is its location, whether it is on the roadway or on an independent alignment. The FHWA Report describes five basic types of facilities to accommodate bicyclists. The Shared Lane or Wide Outside Lane types may be appropriate designs for AASHTO's Shared Roadway (No Bikeway Designation) or Signed Shared Roadway types. The shoulder types may be appropriate designs for AASHTO's Shared Roadway (No Bikeway Designation). The Separate Bike Path correlates to AASHTO's Shared Use Path. The following are FHWA definitions of their five types of bicycle facilities:

- Shared Lane - Shared motor vehicle/bicycle use of a "standard" width travel lane.
- Wide Outside Lane (or wide curb lane) - An outside travel lane with a width of at least 14 feet.
- Bike Lane - A portion of the roadway designated by striping, signing, and/or pavement markings for preferential or exclusive use of bicycles. On urban projects the bike lane width is the distance from the face of the curb to the bike lane stripe. For VDOT projects, the bike lane stripe will lie 4 feet minimum from the edge of a gutter pan and 5 feet minimum from the face of curb.
- Shoulder - A paved portion of the roadway to the right of the edge stripe on which bicyclists may ride. These areas are not marked or signed as 'bike lanes'.

- Separate Bike Path - A facility physically separated from the roadway and intended for bicycle use.

The FHWA publication categorizes bicyclists into three groups. Group A are advanced bicyclists with experience who can operate under most traffic conditions. Group B are basic bicyclists who are casual or new adult and teenage riders with less confidence of their ability to operate in traffic without special provisions for bicycles. Group C, children, are pre-teen riders whose roadway use is initially monitored by parents.

Tables A-5-1 through A-5-6 indicate the appropriate design treatments given various sets of traffic operations and design factors. The design treatments are considered "desirable widths" by the FHWA. There are three basic types of roadway sections for bicycles; urban without parking, urban with parking, and rural. Controlled-access freeways are considered a special case and are not addressed by the tables.

Roadway improvements such as bicycle facilities depend on the roadway's design. Bicycle paths located on independent alignment depend on many factors, including the performance capabilities of the bicyclist and the bicycle. The following tables do not include any specific recommendations for separate bike paths and their design standards are addressed under VDOT/AASHTO Design Guidelines for Shared Use Paths.

average motor vehicle operating speed	average annual daily traffic (AADT) volume											
	less than 2,000				2,000-10,000				over 10,000			
	adequate sight distance		inadequate sight distance		adequate sight distance		inadequate sight distance		adequate sight distance		inadequate sight distance	
		truck,bus,rv				truck,bus,rv				truck,bus,rv		
less than 30 mph	sl 12	sl 12	wc 14	wc 14	sl 12	wc 14	wc 14	wc 14	wc 14	wc 14	wc 14	wc 14
30-40 mph	wc 14	wc 14	wc 15	wc 15	wc 14	wc 15	wc 15	wc 15	wc 14	wc 15	wc 15	wc 15
41-50 mph	wc 15	wc 15	wc 15	wc 15	wc 15	wc 15	sh 6	sh 6	wc 15	wc 15	sh 6	sh 6
over 50 mph	sh 6	sh 6	sh 6	sh 6	sh 6	sh 6	sh 6	sh 6	sh 6	sh 6	sh 6	sh 6

**TABLE A-5-1**

**GROUP A BICYCLISTS, URBAN SECTION, NO PARKING**

(widths are in feet)

For Table A-5-1: wc and sl widths represent “usable widths” of outer lanes, measured from lane stripe to edge of gutter pan, rather than to the face of curb. If no gutter pan is provided, add 1 ft. Minimum for shy distance from the face of curb.

Key: wc = wide curb lane; sh = shoulder; sl = shared lane; bl = bike lane; na = not applicable; truck, buses, and/or recreation vehicles (approximately 30 per hour or more)



average motor vehicle operating speed	average annual daily traffic (AADT) volume												
	less than 2,000				2,000-10,000				over 10,000				
	adequate sight distance		inadequate sight distance		adequate sight distance		inadequate sight distance		adequate sight distance		inadequate sight distance		
		truck,bus,rv				truck,bus,rv				truck,bus,rv			
less than 30 mph	wc 14	wc 14	wc 14	wc 14	wc 14	wc 14	wc 14	wc 14	wc 14	wc 14	wc 15	wc 15	wc 14
30-40 mph	wc 14	wc 14	wc 15	wc 15	wc 14	wc 15	wc 15	wc 15	wc 14	wc 15	wc 15	wc 15	wc 15
41-50 mph	wc 15	wc 15	wc 15	wc 15	wc 15	wc 16	wc 16	wc 16	wc 15	wc 15	wc 16	wc 16	wc 16
over 50 mph	na	na	na	na	na	na	na	na	na	na	na	na	na

**TABLE A-5-2**

**GROUP A BICYCLISTS, URBAN SECTION, WITH PARKING**

(widths are in feet)

For Table A-5-2: wc widths represent “usable widths” of outer travel lanes, measured from the left edge of the parking space (8 to 10 ft. minimum from the curb face) to the left stripe of the travel lane.

Source: FHWA’s “Selecting Roadway Design Treatments to Accommodate Bicycles” dated 1994.

average motor vehicle operating speed	average annual daily traffic (AADT) volume												
	less than 2,000				2,000-10,000				over 10,000				
	adequate sight distance		inadequate sight distance		adequate sight distance		inadequate sight distance		adequate sight distance		inadequate sight distance		
		truck,bus,rv				truck,bus,rv				truck,bus,rv			
less than 30 mph	sl 12	sl 12	wc 14	wc 14	sl 12	wc 14	wc 14	wc 14	wc 14	wc 14	wc 14	sh 4	sh 4
30-40 mph	wc 14	wc 14	sh 4	sh 4	wc 14	wc 15	sh 4	sh 4	sh 4	sh 4	sh 4	sh 4	sh 4
41-50 mph	sh 4	sh 4	sh 4	sh 4	sh 6	sh 6	sh 6	sh 6	sh 6	sh 6	sh 6	sh 6	sh 6
over 50 mph	sh 4	sh 6	sh 6	sh 4	sh 6	sh 6	sh 6	sh 6	sh 6	sh 6	sh 6	sh 6	sh 6

**TABLE A-5-3**  
**GROUP A BICYCLISTS, RURAL SECTION**  
(widths are in feet)

For Table A-5-3: wc and sl widths represent “usable widths” of outer lanes, measured from lane stripe to edge of the pavement if a smooth, firm, level shoulder is adjacent. If rough or dropped pavement edges or a soft shoulder exists, add 1 ft. minimum for shy distance from the edge of the pavement.

Key: wc = wide curb lane; sh = shoulder; sl = shared lane; bl = bike lane; na = not applicable; truck, buses, and/or recreation vehicles (approximately 30 per hour or more)

average motor vehicle operating speed	average annual daily traffic (AADT) volume											
	less than 2,000				2,000-10,000				over 10,000			
	adequate sight distance		inadequate sight distance		adequate sight distance		inadequate sight distance		adequate sight distance		inadequate sight distance	
		truck,bus,rv				truck,bus,rv				truck,bus,rv		
less than 30 mph	wc 14	wc 14	wc 14	wc 14	wc 14	wc 14	wc 14	wc 14	bl 5	bl 5	bl 5	bl 5
30-40 mph	bl 5	bl 5	bl 5	bl 5	bl 5	bl 6	bl 6	bl 5	bl 5	bl 6	bl 6	bl 5
41-50 mph	bl 5	bl 5	bl 5	bl 5	bl 6	bl 6	bl 6	bl 6	bl 6	bl 6	bl 6	bl 6
over 50 mph	bl 6	bl 6	bl 6	bl 6	bl 6	bl 6	bl 6	bl 6	bl 6	bl 6	bl 6	bl 6

**TABLE A-5-4**

**GROUP B/C BICYCLISTS, URBAN SECTION, NO PARKING**

(widths are in feet)

For Table A-5-4: wc widths represent “usable widths” of outer lanes, measured from lane stripe to edge of gutter pan, rather than to the face of curb. If no gutter pan is provided, add 1 ft. minimum for shy distance from the face of curb. bl widths represent the minimum width from the curb face. For VDOT projects, the bike lane stripe will lie 4 feet minimum from the edge of the gutter pan. The bike lane stripe will lie 5 feet minimum from the face of curb.

Source: FHWA’s “Selecting Roadway Design Treatments to Accommodate Bicycles” dated 1994.

average motor vehicle operating speed	average annual daily traffic (AADT) volume												
	less than 2,000				2,000-10,000				over 10,000				
	adequate sight distance		inadequate sight distance		adequate sight distance		inadequate sight distance		adequate sight distance		inadequate sight distance		
	wc	truck,bus,rv		wc	wc	truck,bus,rv		wc	bl	truck,bus,rv		bl	
less than 30 mph	14	14	14	14	14	14	14	14	14	5	5	5	5
30-40 mph	5	5	5	5	5	6	6	5	6	6	6	6	6
41-50 mph	6	6	6	6	6	6	6	6	6	6	6	6	6
over 50 mph	na	na	na	na	na	na	na	na	na	na	na	na	na

**TABLE A-5-5**

**GROUP B/C BICYCLISTS, URBAN SECTION,WITH PARKING**

(widths are in feet)

For Table A-5-5: wc and sl widths represent “usable widths” of outer lanes, measured from the left edge of the parking space (8 to 10 ft. minimum from the curb face) to the left stripe of the travel lane.

Key: wc = wide curb lane; sh = shoulder; sl = shared lane; bl = bike lane; na = not applicable; truck, buses. And/or recreation vehicles (approximately 30 per hour or more)

average motor vehicle operating speed	average annual daily traffic (AADT) volume											
	less than 2,000				2,000-10,000				over 10,000			
	adequate sight distance		inadequate sight distance		adequate sight distance		inadequate sight distance		adequate sight distance		inadequate sight distance	
	truck,bus,rv				truck,bus,rv				truck,bus,rv			
less than 30 mph	sh 4	sh 4	sh 4	sh 4	sh 4	sh 4	sh 4	sh 4	sh 4	sh 4	sh 4	sh 4
30-40 mph	sh 4	sh 4	sh 4	sh 4	sh 4	sh 6	sh 6	sh 4	sh 6	sh 6	sh 6	sh 6
41-50 mph	sh 6	sh 6	sh 6	sh 6	sh 6	sh 6	sh 6	sh 6	sh 6	sh 6	sh 6	sh 6
over 50 mph	sh 6	sh 6	sh 6	sh 6	sh 8	sh 8	sh 8	sh 8	sh 8	sh 8	sh 8	sh 8

**TABLE A-5-6**

**GROUP B/C BICYCLISTS, RURAL SECTION**

(widths are in feet)

Source: FHWA's "Selecting Roadway Design Treatments to Accommodate Bicycles" dated 1994

**VDOT/AASHTO DESIGN GUIDELINES**

The following design guidelines are to assist in the design of bicycle facilities and have been obtained from AASHTO's 1999 "Guide for the Development of Bicycle Facilities" and in combination with VDOT Policy. Only key information from AASHTO's Guide are contained in this VDOT publication. Individuals involved in the planning and design of bicycle facilities should be familiar with and refer to the latest AASHTO Guide for additional information. AASHTO criteria will be considered as "minimum criteria" by designers. These design guidelines consider four types of bicycle facilities: Shared Roadway (No Bikeway Designation), Signed Shared Roadway, Bike Lane or Bicycle Lane and Shared Use Path.

When bicycle facilities are proposed, the roadway conditions will be examined for potential problems specific to bicyclists. Safe drainage grates and railroad crossings, smooth pavements, and signals responsive to bicycles will be provided where warranted. Drainage grate inlets and utility covers in particular are potential problems to bicyclists and should be located in a manner which will minimize severe and/or frequent maneuvering by the bicyclist. When a new roadway is designed, all such grates and covers should be out of the bicyclists' expected path.

## SHARED ROADWAYS

The most critical variable affecting the ability of a roadway to accommodate bicycle traffic is width. Adequate width may be achieved by providing paved shoulders or wide outside lanes.

### Paved Shoulders

Paved shoulders should be at least 4 feet wide to accommodate bicycle travel. However, where 4 foot widths cannot be provided, any additional shoulder width is better than none at all. A shoulder width of 5 feet is recommended from the face of guardrail, curb or other roadside barriers. It is desirable to increase the width of shoulders where higher bicycle usage is expected. Additional shoulder width is also desirable if motor vehicle speeds exceed 50 mph, or the percentage of trucks, buses, and recreational vehicles is high, or if static obstructions exist at the right side of the roadway.

On rural and urban collector and local roads and streets, provide minimum 4 foot wide paved shoulders when:

- a) Design Year ADT > 2000 VPD, with  $\geq 5\%$  total truck and bus usage
- or
- b) The route is an AASHTO Approved Interstate Bicycle Route or designated as a bicycle route on a Locality's Thoroughfare Plan and the graded shoulder width is 6 feet or greater.

For the above situations, the remainder of the shoulder will be topsoil and seeded.

AASHTO's recommendations for shoulder width (as described in *A Policy on Geometric Design of Highways and Streets*) are the best guide for bicycles as well, since wider shoulders are recommended on heavily traveled and high-speed roads and those carrying large numbers of trucks. In order to be usable by bicyclists, the shoulder must be paved.

Rumble strips or raised pavement markers, where installed to discourage or warn motorists they are driving on the shoulder, are not recommended where shoulders are used by bicyclists unless there is a minimum clear path of 1 foot from the rumble strip to the traveled way, 4 feet from the rumble strip to the outside edge of paved shoulder, or 5 feet to adjacent guardrail, curb or other obstacle. If existing conditions preclude achieving the minimum desirable clearance, the width of the rumble strip may be decreased or other appropriate alternative solutions should be considered. VDOT's policy is to not install pavement markers along the outside edge line of a travelway.

## Wide Outside Lanes

Wide outside lanes for bicycle use are usually preferred where shoulders are not provided, such as in restrictive urban areas. On highway sections without designated bikeways, an outside or curb lane wider than 12 feet can better accommodate both bicycles and motor vehicles in the same lane and thus is beneficial to both bicyclists and motorists.

In general 14 feet of usable lane width is the recommended width for shared use in a wide outside lane. Usable width normally would be from edge stripe to lane stripe or from the longitudinal joint of the gutter pan to lane stripe (the gutter pan should not be included as usable width). On stretches of roadway with steep grades where bicyclists need more maneuvering space, the wide outside lane should be slightly wider where practicable (15 feet is preferred). The 15 foot width may also be necessary in areas where drainage grates, raised reflectors on the right-hand side of the road, or on-street parking effectively reduce the usable width. With these exceptions in mind, widths greater than 14 feet that extend continuously along a stretch of roadway may encourage the undesirable operation of two motor vehicles in one lane, especially in urban areas, and therefore are not recommended. In situations where more than 15 feet of pavement width exists, consideration should be given to striping bike lanes or shoulders.

- On-Street Parking

When there is on-street parking on urban roadways, the bicycle riding location is in the area between parked cars and moving motor vehicles. 12 feet of combined bicycle travel and parking width should be the minimum considered for this type of shared use. Striping should be provided to delineate the parking stalls. (See Figure A-5-1)

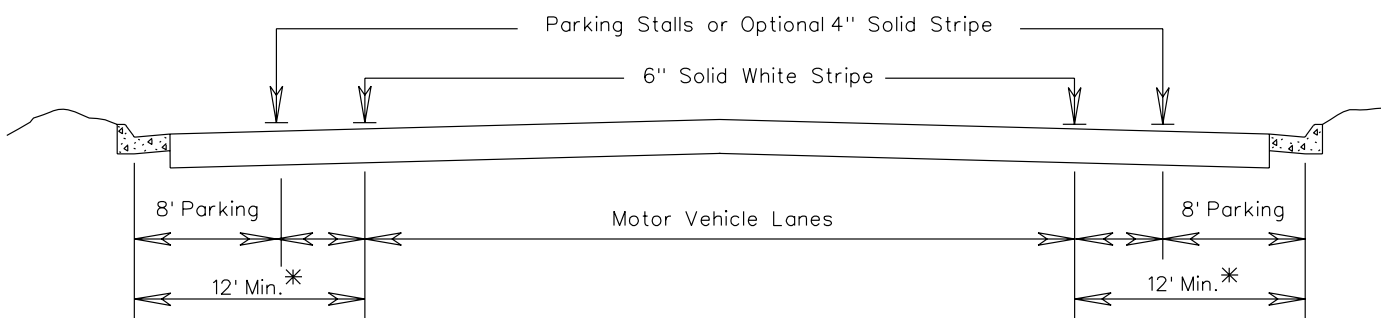

<sup>T</sup>13 feet is recommended where there is substantial parking or turn over of parked cars is high (e.g. commercial areas)

### **PARKING PERMITTED WITH PARKING STRIPE**

(Bike lane not designated or marked)

**FIGURE A-5-1**

## **SIGNED SHARED ROADWAYS**

The distinction between shared roadways and signed shared roadways is that signed are those that have been identified by signing as preferred bike routes.

## **BIKE LANES**

Bike lanes are incorporated into a roadway design when it is desirable to delineate available road space for use by bicyclists and motorists. Delineating bike lanes is not recommended within a required paved shoulder area. Urban settings will typically use a bike lane to accommodate bicyclists. Rural areas will normally make use of a 4' minimum paved shoulder to accommodate bicyclists. Drainage grates, railroad crossings, traffic control devices, etc must be evaluated and modified if necessary for bicycle use.

Bike lanes should be one-way facilities and carry bike traffic in the same direction as adjacent motor vehicle traffic. Two-way bike lanes on one side of the roadway are not recommended when they result in bicycle riding against the flow of motor vehicle traffic. In general, on one-way streets, a bike lane should be placed only on the right side of the street.



### (1) BIKE LANES

(With Curb and Gutter)

(Without Gutter)

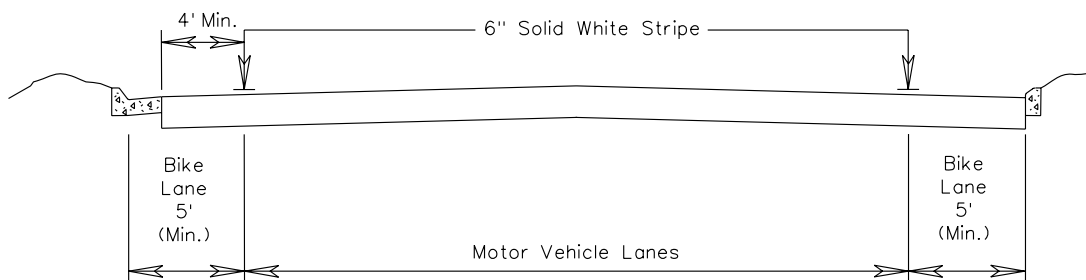

### (2) BIKE LANES WITH ON-STREET PARKING

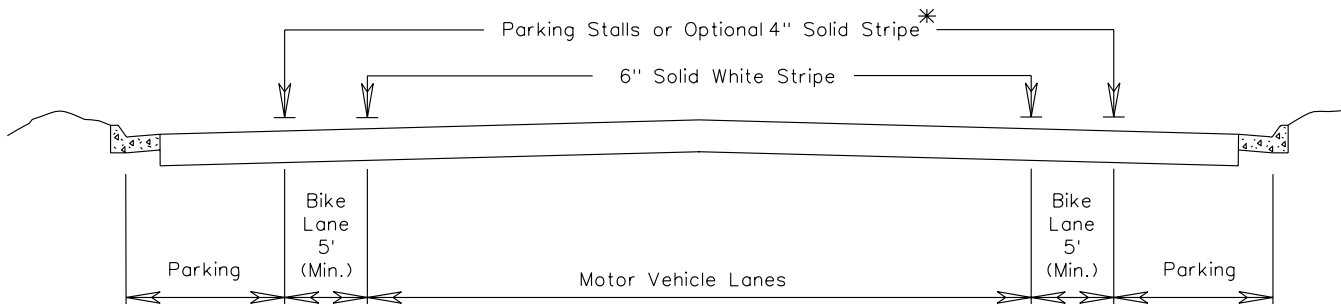

<sup>T</sup>The optional solid white stripe may be advisable where stalls are unnecessary (because parking is light) but there is concern that motorists may misconstrue the bike lane to be a traffic lane.

## TYPICAL BIKE LANE CROSS SECTIONS

FIGURE A-5-2

- Bike Lane Widths

The recommended width of a bike lane is 5 feet from the face of a curb to the bike lane stripe on roadways without a gutter pan. The recommended width of a bike lane is 4 feet from the edge of pavement to the bike lane stripe on curb and gutter roadways. Greater bike lane widths are desirable where substantial truck traffic is present, or where motor vehicle speeds exceed 50 mph. Where vehicle traffic volume is high or substantial truck, bus or recreational vehicle traffic is present or speeds warrant, 6 feet minimum is appropriate to the bike lane stripe from the face of curb. Figure A-5-2, Section (2), depicts a bike lane along the outer portion of an urban curbed street where parking is prohibited.

Bicyclists tend to ride a distance of 32 to 40 inches from a curb face and it is important that the surface in this area be smooth and free of structures. Drain inlets and utility covers that extend into this area may cause bicyclists to swerve, and have the effect of reducing the usable width of the lane. Where these structures exist, the bike lane width may need to be adjusted accordingly.

If parking is permitted, as in Figure A-5-2, Section (2), the bike lane should be placed between the parking area and the travel lane and have a minimum width of 5 feet. Bike lanes should never be placed between the parking lane and curb line.

### Bike Lanes and Turning Lanes

Bike lanes complicate bicycle and motor vehicle turning movements at intersections. It is preferable to continue the same width of bike lane through the intersection. Locations where a bike lane approaches an intersection (4 feet from the edge of pavement on a curb and gutter roadway), the 4 foot wide section should continue parallel to the left of a right turn lane.

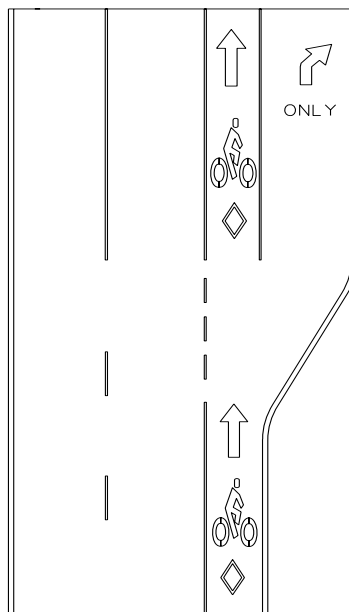

**RIGHT TURN ONLY LANE**

**FIGURE A-5-3**

- Bicycle Lanes Approaching Right-Turn-Only Lanes

NOTES: For other intersection situations see the AASHTO Guide for the Development of Bicycle Facilities. For current typical bicycle lane pavement markings see VDOT Road and Bridge Standards or current insertable sheets.

Figure A-5-3 presents a treatment for pavement markings where a bike lane approaches a motorist right-turn-only lane. The design of bike lanes should include appropriate signing at intersections to warn of conflicts. The approach shoulder width should be provided through the intersection, where feasible, to accommodate right turning bicyclists or bicyclists who prefer to use crosswalks to negotiate the intersection.

## SHARED USE PATHS

Shared use paths are facilities on exclusive right-of-way and with minimal cross flow by motor vehicles. Users are non-motorized and may include bicyclists, inline skaters, roller skaters, wheelchair users (both non-motorized and motorized) and pedestrians including walkers, runners, and people with baby strollers and people walking dogs. Shared use paths are most commonly designed for two-way travel, and the following guidance assumes a two-way facility is planned unless otherwise stated. When paths are planned, it is desirable to provide paths on both sides of the roadway to decrease the likelihood of children crossing the road. Pavement design for shared use paths are recommended by the Materials Division.

- Separation Between Shared Use Paths and Roadways

When two-way shared use paths are located adjacent to a roadway, wide separation between a shared use path and the adjacent highway is desirable to demonstrate to both the bicyclist and the motorist that the path functions as an independent facility for bicyclists and others. When this is not possible and the distance between the edge of the shoulder and the shared use path is less than 5 feet, a suitable physical barrier is recommended. On curb or curb and gutter roadways, when the distance between the travel way (edge of pavement) and the shared use path is less than 5 feet (7 feet recommended for new construction), a suitable physical barrier is recommended. Consideration should be given to future signs or mailboxes, which may require additional clearance. Such barriers serve both to prevent path users from making unwanted movements between the path and the highway shoulder and to reinforce the concept that the path is an independent facility. Where used, the barrier should be a minimum of 42 inches high (54 inches on structures), to prevent bicyclists from toppling over it. A barrier between a shared use path and adjacent highway should not impair sight distance at intersections, and should be designed to not be a hazard to motorists or bicyclist.

- Width and Clearance

The paved width and the operating width required for a shared use path are primary design considerations. Under most conditions, a recommended paved width for a two-directional shared use path is 10 feet. In rare instances, a reduced width of 8 feet can be adequate. This reduced width should be used only where the following conditions prevail:

- (1) bicycle traffic is expected to be low, even on peak days or during peak hours
- (2) pedestrian use of the facility is not expected to be more than occasional
- (3) there will be good horizontal and vertical alignment providing safe and frequent passing opportunities
- (4) during normal maintenance activities the path will not be subjected to maintenance vehicle loading conditions that would cause pavement edge damage. Under certain conditions it may be necessary or desirable to increase the width of a shared use path to 12 feet, or even 14 feet, due to substantial use by bicycles, joggers, skaters and pedestrians, use by large maintenance vehicles, and steep grades.

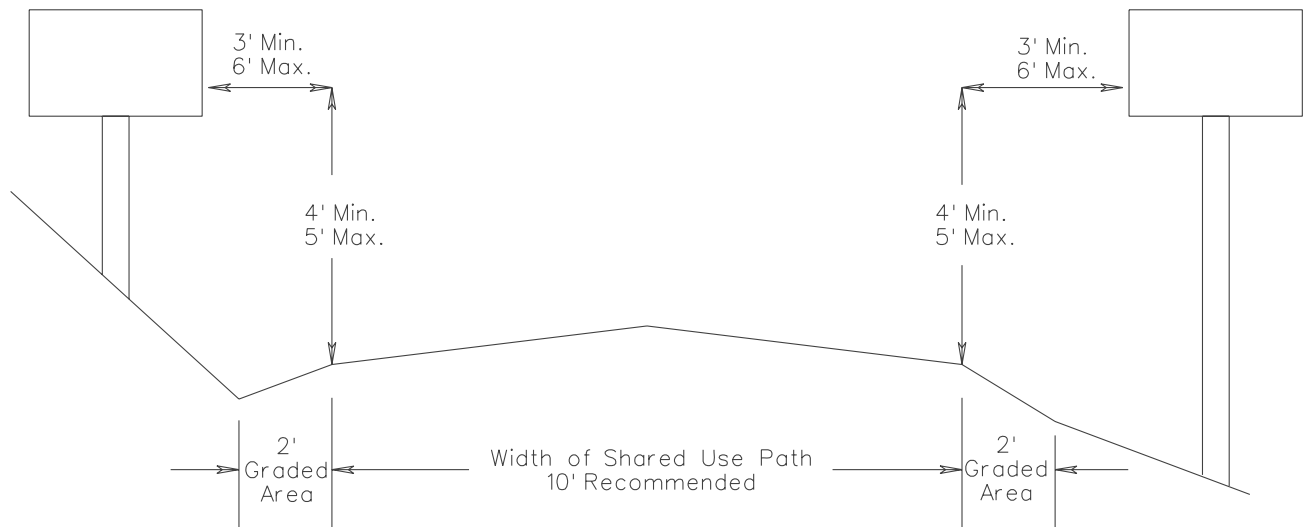

### CROSS SECTION OF TWO-WAY SHARED USE PATH ON SEPARATED RIGHT OF WAY

FIGURE A-5-4

The minimum width of a one-directional shared use path is 6 feet. A one-way path would rarely be designed and only in a special situation. It should be recognized that one-way paths often would be used as two-way facilities unless effective measures are taken to assure one-way operation. Without such enforcement, it should be assumed that shared use paths would be used as two-way facilities by both pedestrians and bicyclists and designed accordingly.

A minimum 2 foot wide graded area should be maintained adjacent to both sides of the path. A minimum 3 foot clearance should be maintained from the edge of the path to signs, trees, poles, walls, fences, guardrail, or other lateral obstructions. Where the path is adjacent to canals, ditches or slopes steeper than 1:3, a wider separation should be considered. A minimum 5 foot separation from the edge of the path pavement to the top of slope is desirable.

Where a slope of 1:2 or greater exist within 5 feet of a path and the fill is greater than 10 feet, a physical barrier such as dense shrubbery, railing or chain link fence should be provided along the top of slope. Other situations may also dictate a physical barrier, such as the height of embankment and condition at the bottom.

The vertical clearance to obstructions should be a minimum of 8 feet. However, vertical clearance may need to be greater to permit passage of maintenance and emergency vehicles. In undercrossings and tunnels, 10 feet is desirable for adequate vertical shy distance.

- Design Speed

Shared use paths should be designed for a selected speed that is at least as high as the preferred speed of the faster bicyclists. In general, a minimum design speed 20 mph should be used. When a downgrade exceeds 4 percent, or where strong prevailing tailwinds exist, a design speed of 30 mph or more is advisable.

- Horizontal Alignment

Most shared use paths built in the United States must also meet the requirements of the Americans with Disabilities Act, ADA guidelines require that cross slopes not exceed 2% to 3% to avoid the severe difficulties that greater cross slopes can create for people using wheelchairs. Thus, for most shared use paths, the maximum superelevation rate will be 3%. When transitioning a 3% superelevation, a minimum 25 foot transition distance should be provided between the end and beginning of consecutive and Reversing horizontal curves.

The coefficient of friction depends upon speed; surface type, roughness, and condition; tire type and condition; and whether the surface is wet or dry. Extrapolating from values used in highway design, design friction factors for paved shared use paths can be assumed to vary from 0.31 at 12 mph to 0.21 at 30 mph.

Based upon various design speeds of 12 to 30 mph and a desirable maximum lean angle of 15°, minimum radii of curvature for Paved **Shared Use** Paths can be selected from Table A-5-7:

Design Speed (V) (mph)	Minimum Radius ® (feet)
12	36
20	100
25	156
30	225

**Minimum Radii for Paved Shared Use PATHS BASED ON 15° LEAN ANGLE**

**TABLE A-5-7**

- Grade

Grades on shared use paths should be kept to a minimum, especially on long inclines. Grades greater than 5 percent are undesirable because the ascents are difficult for many bicyclists to climb and the descents cause some bicyclists to exceed the speeds at which they are competent or comfortable. On some shared use paths, where terrain dictates, designers may need to exceed the 5% grade recommended for bicycles for some short sections. For a general guide maximum grade lengths where the grade must exceed 5% see Table A-5-8.

5 to 6%	<b>For up to 800 feet</b>
7%	For up to 400 feet
8%	For up to 300 feet
9%	For up to 200 feet
10%	For up to 100 feet
11+%	For up to 50 feet

**MAXIMUM GRADE LENGTHS**

**TABLE A-5-8**

- Sight Distance

The following charts indicate the minimum stopping sight distance for various design speeds and grades based on a total perception and brake reaction time of 2.5 seconds and a coefficient of friction of 0.25 to account for the poor wet weather braking characteristics of many bicycles. For two-way shared use paths, the sight distance in the descending direction, that is, where “G” is negative, will control the design.

**Sight Distance Descending Grade (ft/ft)**

	0%	1%	2%	3%	4%	5%	6%	7%	8%	9%	10%	11%	12%	13%	14%	15%	16%	17%	18%	19%	20%
6 mph	27	27	27	27	28	28	28	29	29	30	30	31	31	32	33	34	35	37	39	42	46
12 mph	63	64	65	66	67	68	69	71	72	74	76	78	81	84	88	92	97	104	113	124	140
20 mph	127	129	131	134	137	140	144	147	152	157	162	169	176	185	195	207	222	240	264	296	340
25 mph	175	179	182	186	191	196	201	207	214	222	231	241	252	265	281	300	323	352	389	439	508
30 mph	230	235	241	246	253	260	268	277	287	298	310	324	341	360	383	410	443	485	539	610	710

**MINIMUM STOPPING SIGHT DISTANCE (FT.) DESCENDING GRADE**

**TABLE A-5-9**

**Sight Distance Ascending Grade (ft/ft)**

	0%	1%	2%	3%	4%	5%	6%	7%	8%	9%	10%	11%	12%	13%	14%	15%	16%	17%	18%	19%	20%
6 mph	27	27	26	26	26	26	26	26	26	26	25	25	25	25	25	25	25	25	25	25	25
12 mph	63	63	62	61	61	60	60	59	59	58	58	57	57	57	56	56	56	55	55	55	55
20 mph	127	125	123	121	119	118	116	115	114	113	111	110	109	108	108	107	106	105	104	104	103
25 mph	175	172	169	166	164	161	159	157	155	153	151	150	148	147	145	144	143	141	140	139	138
30 mph	230	225	221	217	214	210	207	204	201	198	196	193	191	189	187	185	183	182	180	178	177

**MINIMUM STOPPING SIGHT DISTANCE (FT.) ASCENDING GRADE**

**TABLE A-5-10**

$$S = \frac{V^2}{30 (f \pm G)} + 3.67 V$$

Where: S = stopping sight distance (feet)  
V = velocity (mph)  
F = coefficient of friction (use 0.25)  
G = grade (ft/ft) (rise/run)

Table A-5-11 indicates the minimum length of vertical curve necessary to provide minimum stopping sight distance at various speeds on crest vertical curves. The eye height of the bicyclist is assumed to be 4.5 feet and the object height is assumed to be 0 inches to recognize that impediments to bicycle travel exist at pavement level.

A (%)	"S" = Stopping Sight Distance (feet)														
	20	40	60	80	100	120	140	160	180	200	220	240	260	280	300
2												30	70	110	150
3								20	60	100	140	180	220	260	300
4						15	55	95	135	175	215	256	300	348	400
5					20	60	100	140	180	222	269	320	376	436	500
6				10	50	90	130	171	216	267	323	384	451	523	600
7				31	71	111	152	199	252	311	376	448	526	610	700
8			8	48	88	128	174	228	288	356	430	512	601	697	800
9			20	60	100	144	196	256	324	400	484	576	676	784	900
10			30	70	111	160	218	284	360	444	538	640	751	871	1000
11			38	78	122	176	240	313	396	489	592	704	826	958	1100
12		5	45	85	133	192	261	341	432	533	645	768	901	1045	1200
13		11	51	92	144	208	283	370	468	578	699	832	976	1132	1300
14		16	56	100	156	224	305	398	504	622	753	896	1052	1220	1400
15		20	60	107	167	240	327	427	540	667	807	960	1127	1307	1500
16		24	64	114	178	256	348	455	576	711	860	1024	1202	1394	1600
17		27	68	121	189	272	370	484	612	756	914	1088	1277	1481	1700
18		30	72	128	200	288	392	512	648	800	968	1152	1352	1568	1800
19		33	76	135	211	304	414	540	684	844	1022	1216	1427	1655	1900
20		35	80	142	222	320	436	569	720	889	1076	1280	1502	1742	2000
21		37	84	149	233	336	457	597	756	933	1129	1344	1577	1829	2100
22		39	88	156	244	352	479	626	792	978	1183	1408	1652	1916	2200
23		41	92	164	256	368	501	654	828	1022	1237	1472	1728	2004	2300
24	3	43	96	171	267	384	523	683	864	1067	1291	1536	1803	2091	2400
25	4	44	100	178	278	400	544	711	900	1111	1344	1600	1878	2178	2500

Heavy line represents S = L

when  $S > L$   $L = 2S - \frac{900}{A}$

L = Minimum Length of Vertical Curve (feet)

A = Algebraic Grade Difference (%)

when  $S < L$   $L = AS^2/900$

S = Stopping Sight Distance (feet)

Height of cyclist eye – 4.5 feet

Minimum Length of Vertical Curve = 3 feet

Height of object – 0 feet

**MINIMUM LENGTH OF CREST VERTICAL CURVE (L) BASED ON STOPPING SIGHT DISTANCE TABLE A-5-11**



Figure A-5-5 and Table A-5-12 indicate the minimum clearance that should be used to line of sight obstructions for horizontal curves. The lateral clearance is obtained from the stopping sight distance and the proposed horizontal radius of curvature. The stopping sight distance is obtained from Table A-5-9 and Table A-5-10.

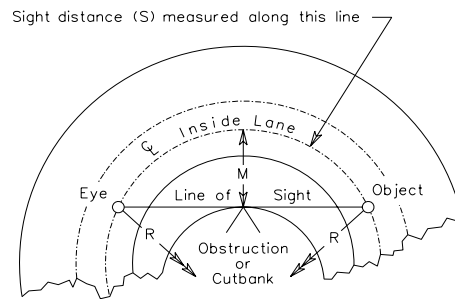

S = Sight distance in feet.  
 R = Radius of  $\mathcal{C}$  inside lane in feet.  
 M = Distance from  $\mathcal{C}$  inside lane in feet.  
 Angle is expressed in degrees

$$M = R \left[ 1 - \cos \left( \frac{28.65 S}{R} \right) \right]$$

$$S = \frac{R}{28.65} \left[ \cos^{-1} \left( \frac{R - M}{R} \right) \right]$$

Line of Sight is 2.3' above  $\mathcal{C}$  inside lane at point of obstruction.

Formula applies only when S is equal to or less than length of curve.

Formula applies only when S is equal to or less than length of curve.  
 Line of sight is 2.3 feet above centerline of inside lane at point of obstruction.

**FIGURE A-5-5**

R (feet)	"S" = Stopping Sight Distance (feet)														
	20	40	60	80	100	120	140	160	180	200	220	240	260	280	300
25	2.0	7.6	15.9												
50	1.0	3.9	8.7	15.2	23.0	31.9	41.5								
75	0.7	2.7	5.9	10.4	16.1	22.8	30.4	38.8	47.8	57.4	67.2				
95	0.5	2.1	4.7	8.3	12.9	18.3	24.7	31.8	39.5	48.0	56.9	66.3	75.9	85.8	
125	0.4	1.6	3.6	6.3	9.9	14.1	19.1	24.7	31.0	37.9	45.4	53.5	61.7	70.6	79.7
155	0.3	1.3	2.9	5.1	8.0	11.5	15.5	20.2	25.4	31.2	37.4	44.2	51.4	59.1	67.1
175	0.3	1.1	2.6	4.6	7.1	10.2	13.8	18.0	22.6	27.8	33.5	39.6	46.1	53.1	60.5
200	0.3	1.0	2.2	4.0	6.2	8.9	12.1	15.8		24.5	29.5	34.9	40.8	47.0	53.7
225	0.2	0.9	2.0	3.5	5.5	8.0	10.8	14.1	17.8	21.9	26.4	31.3	36.5	42.2	48.2
250	0.2	0.8	1.8	3.2	5.0	7.2	9.7	12.7	16.0	19.7	23.8	28.3	33.1	38.2	43.7
275	0.2	0.7	1.6	2.9	4.5	6.5	8.9	11.6	14.6	18.0	21.7	25.8	30.2	34.9	39.9
300	0.2	0.7	1.5	2.7	4.2	6.0	8.1	10.6	13.4	16.5	19.9	23.7	27.7	32.1	36.7
350	0.1	0.6	1.3	2.3	3.6	5.1	7.0	9.1	11.5	14.2	17.1	20.4	23.9	27.6	31.7
390	0.1	0.5	1.2	2.1	3.2	4.6	6.3	8.2	10.3	12.8	15.4	18.3	21.5	24.9	28.5
500	0.1	0.4	0.9	1.6	2.5	3.6	4.9	6.4	8.1	10.0	12.1	14.3	16.8	19.5	22.3
565		0.4	0.8	1.4	2.2	3.2	4.3	5.7	7.2	8.8	10.7	12.7	14.9	17.3	19.8
600		0.3	0.8	1.3	2.1	3.0	4.1	5.3	6.7	8.3	10.1	12.0	14.0	16.3	18.7
700		0.3	0.6	1.1	1.8	2.6	3.5	4.6	5.8	7.1	8.6	10.3	12.0	14.0	16.0
800		0.3	0.6	1.0	1.6	2.2	3.1	4.0	5.1	6.2	7.6	9.0	10.5	12.2	14.0
900		0.2	0.5	0.9	1.4	2.0	2.7	3.6	4.5	5.6	6.7	8.0	9.4	10.9	12.5
1000		0.2	0.5	0.8	1.3	1.8	2.4	3.2	4.0	5.0	6.0	7.2	8.4	9.8	11.2

**MINIMUM LATERAL CLEARANCE (M) FOR HORIZONTAL CURVES**

**TABLE A-5-12**

Bicyclists frequently ride side-by-side on shared use paths, and on narrow paths bicyclists have a tendency to ride near the middle of the path. For these reasons, and because of the higher potential for bicycle crashes, lateral clearances on horizontal curves should be calculated based on the sum of the stopping sight distances for bicyclists traveling in opposite directions around the curve. Where this is not possible or feasible, consideration should be given to widening the path through the curve, installing a yellow center line stripe, installing a "Curve Ahead" warning sign in accordance with the MUTCD, or some combination of these alternatives.

- Path-Roadway Intersections

Intersections between paths and roadways are often the most critical issue in shared use path design. Due to the potential conflicts at these junctions, careful design is of paramount importance to the safety of path users and motorists. Solutions are provided in the AASHTO guide and should be considered as guidelines, and not as absolutes. Each intersection is unique, and will require sound engineering judgment on the part of the designer as to the appropriate solution. Shared use paths should cross roadways as close to an intersecting road as practical, however, in no case should the crossing be closer than 4 feet from the edge of the parallel travelway. As the Path approaches the crossing it should be aligned with the destination of the crossing on the other side of the road. Curb cuts should be appropriately aligned and be the same width as the path. The crossing should also be perpendicular (or nearly so) to the road being crossed. Normally, two curb cuts are recommended at each corner where a path crosses an intersection. Sight distance should be evaluated and sound engineering judgement must be used in locating crossings. There may be situations, such as low traffic volumes where the crossing should be located further from the intersection.

When a shared use trail intersects a road, with no sidewalk, the trail should slope to a relatively level ( $1\% \pm$  slope) area at the road elevation and the curb opening should be the same width as the trail. This layout would be similar to the Typical Alternate Plan seen in VDOT's CG-12 Standard. The level area should be of exposed aggregate. If a sidewalk exist along the road, then the sidewalk must also slope to the same relatively level area at the road elevation.

When a paved shared use path or trail crosses a gravel road or drive, the road or drive should be paved a minimum of 3 feet, on each side of the path or trail.

- Signing and Marking

Adequate signing and marking are essential on shared use paths, especially to alert bicyclists to potential conflicts and to convey regulatory messages to both bicyclists and motorists at highway intersections. In addition, guide signing, such as to indicate directions, destinations, distances, route numbers and names of crossing streets, should be used in the same manner as they are used on highways. In general, uniform application of traffic control devices, as described in the MUTCD, provides minimum traffic control measures which should be applied.

- Pavement Structure

Hard, all weather pavement surfaces are preferred over those of crushed aggregate, sand, clay, or stabilized earth since these materials provide a much lower level of service and require higher maintenance.

- Structures

On new structures, the minimum clear width should be the same as the approach paved shared use path, plus the minimum 2 foot wide clear areas on both sides of the path. Carrying the clear areas across the structures provides a minimum horizontal shy distance from the railing or barrier and it provides needed maneuvering space to avoid conflicts with pedestrians and other bicyclists who are stopped on the bridge. The typical section, including the shared use path and the 2 foot wide clear areas, may be modified by the State Structure and Bridge Engineer because of expected low bicycle volume, budget considerations, or other reasons. Railings, fences, or barriers on both sides of a path on a structure shall be a minimum of 54 inches (4.5 feet) high. In situations where the structure crosses a high speed or high volume road and objects are subject to being thrown (dangerously) off the structure, it maybe desirable to totally enclose the path with fencing. Totally enclosing a path may also be desirable in other areas such as a waterway crossing.

- Drainage

The recommended minimum pavement cross slope of 2 percent adequately provides for drainage. Sloping in one direction instead of crowning is preferred and usually simplifies the drainage and surface construction. A smooth surface is essential to prevent water ponding and ice formation. On unpaved shared use paths, particular attention should be paid to drainage to avoid erosion.

- Lighting

Lighting for shared use paths is important and should be considered where night usage is expected, such as paths serving college students or commuters, and at highway intersections. Lighting should also be considered through underpasses or tunnels, and when nighttime security could be an issue.

- Restriction of Motor Vehicle Traffic

Shared use paths may need some form of physical barrier at highway intersections to prevent unauthorized motor vehicles from using the facilities. Provisions can be made for a lockable, removable (or reclining) barrier post to permit entrance by authorized vehicles.

- Railroad Crossings

Railroad-highway grade crossings should be at a right angle to the rails. The greater the crossing deviates from this ideal crossing angle, the greater is the potential for a bicyclist's front wheel to be trapped in the flangeway causing loss of steering control. Consideration should be given to the crossing surface materials and to the flangeway depth and width.

- Bicycle Facilities Through Interchange Areas

Turning roadways provided for interchange ramp ingress and egress often require bicyclists to perform merging, weaving or crossing maneuvers with other vehicles. These conflict points are made challenging when a wide disparity in speed exists between traffic on the ramp and bicycle traffic crossing the ramp, and when grade separations create significant profile gradients. If a bike lane or route must traverse an interchange area, these intersection or conflict points should be designed to limit the conflict areas or to eliminate unnecessary uncontrolled ramp connections to urban roadways.

## **AASHTO APPROVED INTERSTATE BICYCLE ROUTES**

VDOT provides signing along the designated AASHTO approved Interstate Bicycle Routes. Figure A-5-6 shows the corridors for Interstate Bicycle Routes 1 and 76 and the counties the routes pass through. The individual county maps provide detailed location information. County maps are to be checked by the plan designer to determine if their project is on a designated Interstate Bicycle Route. All proposed projects involving major construction or redevelopment along designated Interstate Bicycle Routes are to provide the necessary design features to facilitate bicycle travel in accordance with the parameters established in these guidelines.

## **RESOURCES**

It should be understood that this Guide is not all inclusive. The publications listed below will provide additional information to be used in the design of bicycle facilities.

“Guide for the Development of Bicycle Facilities.” AASHTO

“Manual on Uniform Traffic Control Devices.” Federal Highway Administration

“Selecting Roadway Design Treatments to Accommodate Bicycles.” Federal Highway Administration

“A Virginia Guide for Bicycle Facility Planning.” Virginia Department of Transportation

# Interstate Bicycle Routes 1 and 76

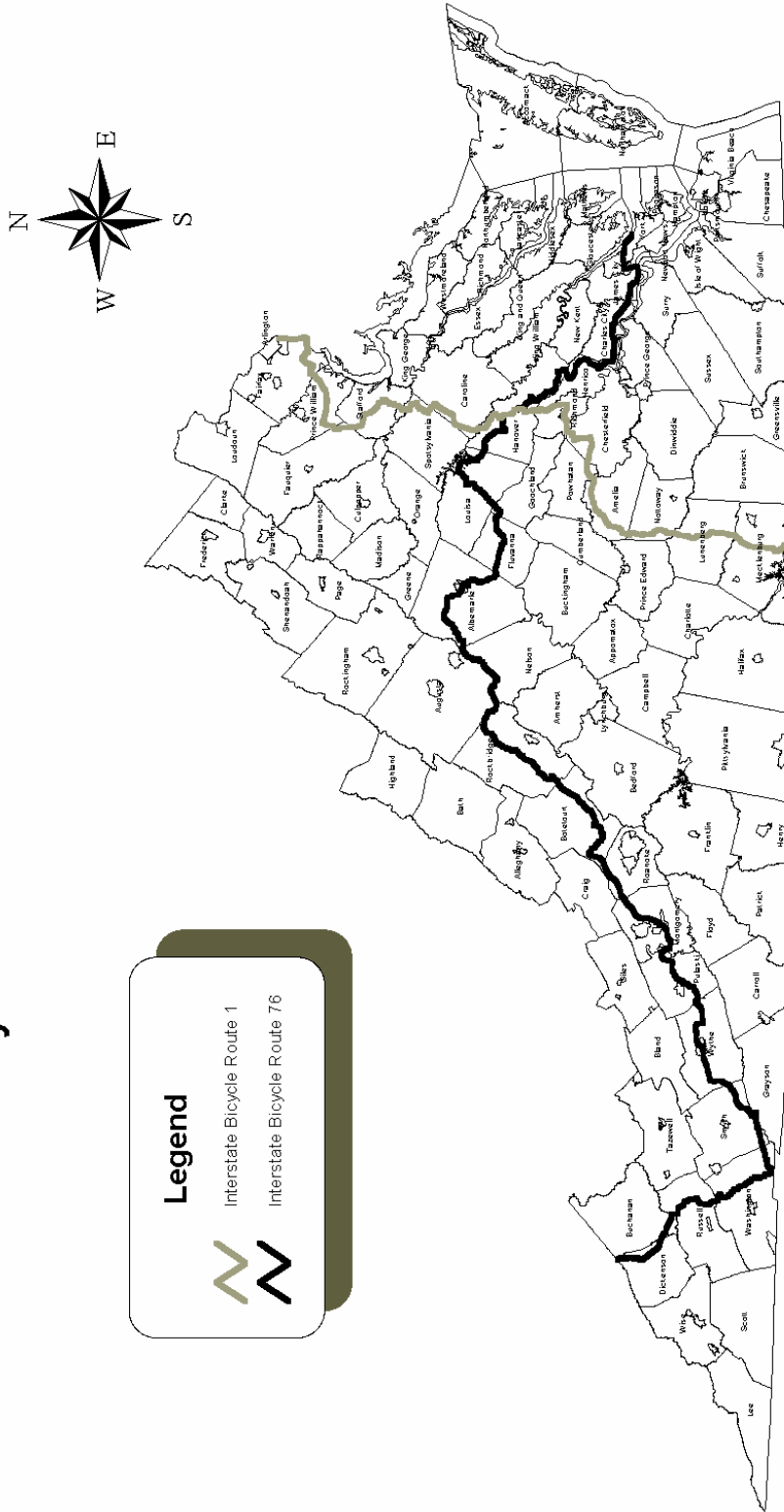

FIGURE A-5-6

feet	meters		mph	km/h		inches	mm
1	0.3		12	20		4	100
2	0.6		20	30		6	150
3	0.9		25	40			
4	1.2		30	50			
5	1.5		50	80			
6	1.8		55	85			
7	2.1					inches	meters
8	2.4					32	0.8
9	2.7					40	1.0
10	3.0					42	1.1
11	3.4						
12	3.6						
13	3.9						
14	4.2						
15	4.5						
16	4.9						

**CONVERSIONS FROM IMPERIAL UNITS TO METRIC UNITS**  
(for bicycle guidelines)

TO CONVERT	MULTIPLY BY	TO OBTAIN
feet	0.3048	meters
mph	1.6093	km/h
inches	0.0254	meters
inches	25.4	mm

- 1 foot = 0.3048 meter
- 1 mph = 1.6093 km/h
- 1 inch = 0.0254 meter
- 1 inch = 25.4 mm

**CONVERSION FACTORS FOR DIMENSIONS OR SPEEDS NOT SHOWN ABOVE :**

**TABLE A-5-13**

## **SECTION A-6 AIRPORT CLEARANCE REQUIREMENTS**

During the Project Planning Stage, the Designer will determine if there is a potential for substandard airway - highway clearance, or other potential hazard, as determined by the project's location listed below:

1. Within 20,000 feet of public use or military airports with at least one runway greater than 3,200 feet in length.
2. Within 10,000 feet of public use or military airports with runways with a length of 3200 feet or less.
3. Within 5,000 feet of public use, military, or hospital heliports.
4. Any permanent or temporary construction or alteration including any equipment, materials or apparatus that would be more than 200 feet in height above ground level at its site.
5. Construction of wetlands or stormwater management ponds within 5 miles of a public use or military airport.

The Designer will request a review and coordinate notice requirements for any project determined to be within the applicable limits as listed above. A list of airports, as of the printing of these instructions, is provided at the end of this section for assistance in locating applicable airports. The request for review will be made to the Location & Design Airport Clearance Coordinator in the Photogrammetry and Survey Section by Form LD-252.

The Airport Clearance Coordinator will determine current Federal Aviation Administration (FAA) requirements pertaining to the subject project and notify the FAA as early as possible. Part 77 of the Federal Aviation Regulations and the U. S. Department of Transportation FAA Advisory Circular 70/7460-21 contain FAA requirements as of the printing of these instructions.

All evaluations will be determined by using U.S.G.S. or N.G.S. (U.S.C. & G.S.) datum or datum matching quadrangle sheets. In no case will assumed data or local city or town datum be used.

When a new corridor is being developed or an existing corridor is being redeveloped to add lanes, interchanges, etc., the entire corridor is to be reviewed for clearance requirements at a very early stage.

For Final Design, the corridor will probably be divided into multiple projects and be handled by different design sections and/or in a District Office. The establishment of the proposed grade elevations based on the airport clearance requirements at an early stage is important because grade adjustments on a Final Design Project by a section may create major design adjustments on an adjoining project that is being prepared by another section or District Office.

When lighting is required on a project or a possible addition in the future, the pole heights are to be considered in the initial review for clearance requirements. Although a highway may present no problems with vertical clearances, the use of certain types of materials (such as fencing, lighting, etc.) may affect navigational equipment. Also, the use of large construction equipment (such as cranes) may cause encroachment of navigable airspace. Encroachment problems may also result from signs and/or lighting added several years after the roadway completion.

When proposed construction or maintenance activities initiated by other Divisions (i.e. Environmental, Structure and Bridge, Maintenance, Traffic Engineering) or a District Office are within the limits (specified earlier in this section) of airports or heliports, the Location and Design Highway Airport Clearance Coordinator is to be notified by Form LD-252.

When potential clearance conflicts are determined, the designer will contract the Highway Airport Clearance Coordinator via Form LD-252 and request a review. The Designer will submit Form LD-252; one (1) print of the title, typical section(s), and applicable plan and profile sheets for the Highway Airport Clearance Coordinator's review.

The Highway Airport Clearance Coordinator will evaluate the appropriate desirable clearance dimensions between highway surfaces and airway approach zones and, if necessary, request that the designer furnish prints of applicable project plan sheets. This is for early communication between the FHWA, FAA, and the Department and for alerting the FAA of potential hazards to aviation.

When a potential problem exists, FAA Form 7460-1 (notice of proposed construction or alternation), or current form, along with appropriate project review data will be filled by the Highway Airport Clearance Coordinator. A Notice of Construction or Alteration to the Federal Aviation Administrator is required for any proposed construction or alteration. This applies to, but is not limited to, the following:

1. Any object of natural growth or terrain.
2. Permanent or temporary construction or alteration, including equipment or materials used therein, and/or apparatus of a permanent or temporary character.



3. Structures with a change in height (including appurtenances) or lateral dimensions, including equipment or materials used therein.
4. Proposed changes in the land use practices that would attract or sustain hazardous wildlife populations at or near airports.

<b>ASSOCIATED CITY</b>	<b>AIRPORT</b>
Abingdon	Virginia Highlands Airport
Ashland	Hanover County Municipal Airport
Blacksburg	Virginia Tech Airport
Blackstone	Blackstone AAF/A. C. Perkinson
Bridgewater	Bridgewater Airpark
Brookneal	Brookneal-Campbell County Airport
Bumpass	Lake Anna Airport
Charlottesville	Charlottesville-Albemarle Co. Airport
Chase City	Chase City Airport
Chesapeake	Chesapeake Municipal Airport
Chesterfield	Chesterfield County Airport
Clarksville	Marks Municipal Airport
Crewe	Crewe Municipal Airport
Culpeper	Culpeper County Airport
Danville	Danville Regional Airport
Dublin	New River Valley Airport
Emporia	Emporia Municipal Airport
Farmville	Farmville Municipal Airport
Forest	New London Airport
Franklin	Franklin Municipal Airport
Fredericksburg	Shannon Airport
Front Royal	Front Royal-Warren County Airport
Galax	Twin County Airport
Gordonsville	Gordonsville Municipal Airport
Grundy	Grundy Municipal Airport
Hot Springs	Ingall's Field
Kenbridge	Lunenburg County Airport
Lawrenceville	Lawrenceville-Brunswick Co. Airport
Leesburg	Leesburg Municipal Airport
Louisa	Louisa County Airport/Freeman Field
Luray	Luray Caverns Airports
Lynchburg	Falwell Airport Lynchburg Regional Airport
Manassas	Manassas Municipal Airport Whitman Strip
Marion/ Wytheville	Mountain Empire

-continued-

**ASSOCIATED CITY      AIRPORT**

Martinsville	Blue Ridge Airport
Melfa	Accomack County Airport
Moneta	Smith Mountain Lake Airport
New Market	New Market Airport
Newport News	Newport News-Williamsburg International
Norfolk	Norfolk International Airport
Orange	Orange County Airport
Pennington Gap	Lee County Airport
Petersburg	Petersburg-Dinwiddie Airport
Portsmouth	Hampton Roads Airport
Quinton	New Kent Airport
Tazewell	Tazewell Airport
Richmond	Richmond International Airport
Chesterfield County	Chesterfield County Airport
Hanover County	Hanover County Municipal Airport
New Kent County	New Kent County Airport
Roanoke	Roanoke Regional Airport
Saluda	Hummel Field
Somerville	Hartwood Airport
South Boston	William M. Tuck Airport
South Hill	Mecklenburg-Brunswick Airport
Staunton	Shenandoah Valley Regional Airport
Suffolk	Suffolk Municipal
Tangier	Tangier Island Airport
Tappahannock	Tappahannock Municipal Airport
Wakefield	Wakefield Municipal Airport
Warrenton	Warrenton-Fauquier Airport
Washington, D.C.	Washington Dulles International Airport
Washington National	Washington National Airport
Waynesboro	Eagle's Nest
Weirwood	Kellam Field
West Point	West Point Municipal
Williamsburg	Williamsburg - Jamestown Airport
Newport News-Williamsburg	Newport News-Williamsburg International
Winchester	Winchester Regional Airport
Wise	Lonesome Pine Airport

**Associated Area      Military Airfields**

Fort Belvoir	Davidson AAF
Fort Eustis	Felker AAF
Norfolk	NAS Norfolk
Poquoson	Langley
Quantico	MCAF Quantico
Va. Beach	NAS Oceana
	NALF Fentress

## **SECTION A-7-"NO PLAN" AND "MINIMUM PLAN" PROJECTS**

### **GENERAL CONCEPTS**

#### **Description**

The "No Plan" and "Minimum Plan" concept provides for the accomplishment by contract of the type improvements that would not require complete and detailed surveys and plans, and where the use of modified Specifications would be appropriate. Generally, the improvements will consist of widening, grading, draining and stabilizing primary and secondary roads with relatively low traffic volumes by using engineering judgment. "No Plan" and "Minimum Plan" concepts are to be used only for projects where significant reductions in the cost of engineering and construction can be experienced by using these concepts to obtain the quality of improvement necessary for the particular situation. To optimize the usefulness of this concept, very careful initial study and project selection by the District and Residency staff is required. The Federal Highway Administration has concurred with the use of the "No Plan" and "Minimum Plan" concept on selected projects with Federal Oversight.

"No Plan" projects are used when no survey, engineering, hydraulic analysis or river mechanics studies are needed or when there will be no major structures with "B" or "D" designation numbers. Right of way may be acquired on "No Plan" projects provided it is acquired thru donations and no condemnation is required. A "No Plan" project is an assembly of letter size sketches showing the location of the project with a typical cross section and estimated quantities.

A "Minimum Plan" project differs in that limited survey is needed to provide the information necessary to secure right of way by the Right of Way and Utilities Division and a profile sheet is provided. In the establishment of such projects, attention should be given to determine that the project location and selection is in an area where disruption due to construction can be tolerated by the users of that particular roadway for a reasonable period of time.

### **PUBLIC HEARING AND RIGHT OF WAY**

All right of way negotiations are to be conducted in accordance with the applicable statutes, regulations, policies, and procedures stipulated in the Right of Way and Utilities Division's Manual of Instructions and related memoranda.

Rev. 7/06 Any required right of way and/or easements will normally be secured by donation. However, right of way may be purchased by individual deeds or under the minimum plan concept (see - second paragraph under "Minimum Plan" Projects).

The Commonwealth Transportation Board's resolution of February 16, 1961 specifies a minimum 40-foot right of way is to be provided for any initial improvement to the secondary system, except in extenuating circumstances.

Section 33.1 - 70.1, Code of Virginia permits consideration for hard surfacing of a secondary road on less than a 40-foot right of way.

#### Right of Way - Donations

Public hearing requirements will normally be waived on "No Plan" and "Minimum Plan" projects when all landowners are willing to donate the right of way provided there is no evidence of controversy, the landowners have been advised of their right to receive just compensation prior to requesting donations, and the project files have been so documented.

#### Right of Way - Acquisitions

When right of way must be acquired, a "Willingness to Hold a Public Hearing" will be advertised and public hearings will be conducted upon request. A public hearing handout and appropriate environmental document, on projects with Federal Oversight, will be prepared following the usual guidelines. If there are questions concerning the public hearing requirements or procedures, check with the State Location and Design Engineer.

### **SPECIAL DESIGN STRUCTURES, SOIL SURVEY AND PAVEMENT DESIGN**

"No Plan" projects may include drainage structures; however, major structures with "B" or "D" designation numbers and all standard box culverts that require a hydraulic study are to be constructed under the "Minimum Plan" concept. When pipes are to be extended and endwalls, end sections, pipe spillouts, etc., are to be provided, separate bid items are to be set up.

The District Materials section is to review the project site to determine if soil samples may be necessary and the District Materials Engineer is to furnish recommendations regarding any undercutting and pavement design.

### **MOBILIZATION AND FIELD OFFICE**

Mobilization is to be set up as a contract item on "No Plan" and "Minimum Plan" projects in accordance with VDOT's Road and Bridge Specifications.

When it is necessary to set up a field office, it is set up as a contract item in accordance with VDOT's Road and Bridge Specifications at the discretion of the District; however, other arrangements should be considered such as the use of existing facilities where feasible to eliminate the need for the extra cost of a field office.

## **EROSION AND SEDIMENT CONTROL**

Temporary and permanent erosion and sediment control measures are required in accordance with the Department's standard practices and procedures. Seeding operations, erosion control, and sedimentation measures shall be included as specific contract items in accordance with standard specifications and procedures or shall be performed by State Forces, at the discretion of the District. When seeding operations and other items are to be performed by State Forces, a plan note must be included to denote such State Force work; and, in the event of Federal Oversight, finding of cost effectiveness must be furnished in accordance with existing policy and procedures.

## **CONTRACT TIME LIMIT**

Generally, a 90 to 180 calendar day time limit should be established; however, the contract time limit should be determined after thorough consideration of the need to realize the lowest cost possible to provide the improvement at the earliest practical date.

## **PROCEDURES**

### **General**

A general description of the work must be provided on Form C-99 (No Plan and Minimum Plan Quantity Support Report) and the Field Narrative to denote the nature of the work to be performed, such as daylighting of slopes; realignment; intersection improvement; or widening of shoulders and ditchlines are to be completed by the District Construction Engineer or the District Administrator's Staff. "Simple" sketches may be used in lieu of the narrative. They are to be submitted with the project assembly for the purpose of providing information concerning the general description of construction work from which to develop and support the construction cost estimate. For all projects disturbing more than 10,000 square feet of soil (or greater than 2,500 square feet of soil in Tidewater Virginia), a plan narrative or sketch with profile which must include erosion and sediment control measures and specify placement of those items. Stormwater management facilities may be addressed in a similar fashion provided sufficient detail is included to ensure their proper construction. Sketches shall be included in the no-plan assembly to define the construction of these items. The Field Narrative will also become part of the contract assembly.

## PROJECT SCOPING & INITIAL FIELD REVIEW

All projects are to be scoped and an Initial Field Review is to be held in accordance with IIM LD-210. These procedures will define the potential need for field and office engineering as well as right of way and environmental requirements.

### "NO PLAN" PROJECTS

The "No Plan" concept should be used when:

- (a) survey data is not required
- \*(b) improvements to roadways do not involve major structures or special design items
- \*(c) Hydraulic or River Mechanics Studies are not required.
- (d) rights of way are acquired thru donations and no condemnation is required.
- (e) environmental permits will not normally be required
- (f) construction activities must be handled in an expeditious manner
- (g) detailed engineering is not required

\* Exception - when a project requires an extensive study (survey, hydraulic or river mechanics study, etc.) for a major structure, the "No Plan" concept may be used only if the necessary studies for the structure design are performed. When a major structure is located on a long No Plan project, the site should be treated as a Minimum Plan exception to the No Plan Project.

The District Construction Engineer normally obtains any donated right of way by use of the appropriate Right of Way Forms. When a "No Plan" project is to be constructed within existing right of way, a note must be placed on the title sheet indicating that "All construction is to be performed within existing right of way."

Metes and bounds plans are required for right of way from unique clients (e.g. Federal and State agencies, the National Forest, railroads, Virginia Power, etc.) - see VDOT's Road Design Manual Chapter 2E, Section 2E-5.

The construction baseline should generally follow the center of the existing roadway; however, minor relocation and alignment improvements (horizontal and vertical), roadway widening, and turn lanes may be accomplished. The geometrics should comply with the appropriate design standards. However, where it is impractical or not economical to obtain the minimum design and an exception is required, permission shall be secured from the State Location and Design Engineer and, if applicable, from the Federal Highway Administration.

The **Project Manager**, with the assistance of the project designer, determines the typical section and furnishes an estimate of quantities on the "Quantity Support Report" Form C-99. Grading should generally be balanced and set up as a lump sum quantity. Form C-99 should indicate an estimate of grading quantities, including anticipated waste quantities, to guide the Scheduling and Contract Division in preparing the construction cost estimate.

When borrow material is anticipated, "Borrow Excavation" is to be set up as a separate bid item in accordance with VDOT's Road and Bridge Specifications. Borrow sources should be located and designated whenever possible in accordance with VDOT's Road Design Manual Chapter 2E, Section 2E-1 - SOIL SURVEY AND PAVEMENT DESIGN.

A unit price for extra excavation is to be established by the **District Construction Engineer** or the District Administrator's staff and entered on Form C-99 for inclusion in the contract assembly by the contract section.

The **Project Manager** is responsible for conducting the utility field inspections and preparing the field inspection reports, determining utility conflicts, method of adjustment, cost responsibility and for obtaining and forwarding all plans and estimates from utility owners to the District Administrator (District Utilities Engineer) for processing. The **District Construction Engineer** is also responsible for advising the District Administrator (District Utilities Engineer) in writing, no later than 60 days prior to the advertisement of the project, when all arrangements have been made with the utility owners to adjust the utilities prior to or in conjunction with project construction. The Central Office Right of Way and Utilities Division will obtain any necessary FHWA authorization for utility work and will furnish the usual utility clearances and estimates to the Scheduling and Contract Division for contract projects and State Force projects with Federal Oversight. If no known utilities and/or railroads are involved, the plans will contain a note so stating.

The responsibility for compliance with applicable regulations, policies and standards is assumed by the District Administrator for "No Plan" secondary projects. The State Location and Design Engineer is responsible for all other roadway classifications. This responsibility is evidenced by affixing the signature of the District Administrator or the State Location and Design Engineer in the appropriate plan signature space.

On Secondary "No Plan" projects, the project designer will transmit the plan assembly directly to the Central Office Plan Coordination Section for processing, construction advertisement or authorization for State Force work on projects with Federal Oversight, whichever is applicable. Primary "No Plan" projects will continue to be transmitted to the Central Office Coordination Section for processing and recommended approval for advertisement. Construction plans will be retained in the District until right of way has been secured and arrangements made for utility adjustments. When retained, status reports (containing applicable correspondence) will be submitted the by District Administrator's staff by the plan-due-date and quarterly until clear.

## "MINIMUM PLAN" PROJECTS

Those sites that require an engineering evaluation should be designated as "Minimum Plan" projects. This will permit the development of required engineering studies and will provide a vehicle for transmitting critical information to the contractor.

Projects that should be developed with the "Minimum Plan" concept include:

- (a) locations requiring survey
- (b) major stream crossing sites
- (c) locations that will require environmental evaluation and/or permits
- (d) all projects with "B" and "D" designation numbers
- (e) locations requiring Hydraulic or River Mechanics studies
- (f) locations that involve the acquisition of right of way and/or condemnation

The basic difference between the "Minimum Plan" and the "No Plan" project is the need for a limited survey and topo to provide sufficient right of way plans necessary to acquire right of way. Form RW-205 or individual deed forms are to be used. If any additional right of way or easements are necessary, the usual right of way certification letter and release for advertisement will be required. If additional right of way or easements are not required, the "Minimum Plan" title sheet is to contain a note indicating that "All construction is to be performed within existing right of way."

"Minimum Plan" projects may include relocation or alignment improvements (horizontal or vertical), roadway widening, and the addition of turn lanes. The intent of the "Minimum Plan" project is for it to be constructed using engineering judgment; however, the complete project should not be required to be redesigned during construction. Special attention should be given to major drainage problems and the limits set for the proposed right of way. The geometrics should comply with the appropriate design standards. However, where it is impractical or not economical to obtain minimum design and an exception is required, permission must be secured from the State Location and Design Engineer and, if applicable, from the Federal Highway Administration.

Quantities, typical sections, entrance profiles and other similar information should be shown on the initial plan and profile sheets. A grade line is required when the grade is to be different than that of the existing road. In areas where right of way is to be obtained and entrance grading is necessary, a profile showing the approximate grade of the proposed entrance should be included in the plan assembly.

When borrow material is anticipated, "Borrow Excavation" is to be set up as a separate bid item in accordance with Section 303 of VDOT's Road and Bridge Specifications. Borrow sources should be located and designated, whenever possible, in accordance with VDOT's Road Design Manual, [Chapter 2E, Section 2E-1](#) - SOIL SURVEY AND PAVEMENT DESIGN.



A unit price for extra excavation is to be established by the **District Construction Engineer** or the District Administrator's staff and entered on Form C-99 for inclusion in the contract assembly by the contract section.

Utility adjustments shall be handled in accordance with IIM LD- 140 and 203.

A general description of work must be provided on Form C-99 and the Field Narrative to denote additional work that is not covered on the plans.

For all projects disturbing more than 10,000 square feet of soil (or greater than 2,500 square feet of soil in Tidewater Virginia\*\*), an Erosion and Sediment Control Plan must be developed, reviewed, and approved by appropriate qualified personnel in accordance with the latest version of IIM LD- 11.

For all projects disturbing greater than one acre of land, a Stormwater Management Plan must be developed, reviewed, and approved by appropriate qualified personnel in accordance with the latest version of IIM LD- 195.

\*\* Tidewater, VA, as defined by the Virginia Chesapeake Bay Preservation Act, Title 10.1, Chapter 21, Code of Virginia.

## **PERMITS AND REVIEWS ("NO PLAN" AND "MINIMUM PLAN" PROJECTS)**

The need for 401, 404, navigation, and other environmental permits is to be considered in accordance with the Guidelines for the Preparation of Permit Application. A Virginia Pollutant Discharge Elimination System (VPDES) permit is required on all projects with a total disturbed area of more than five continuous acres. (Request Form LD-252).

Historical and archaeological reviews are to be made. (Request Forms LD-252 and EQ-429).

For any project that disturbs greater than one acre of soil, (except certain maintenance projects specifically exempted by the General VPDES Construction Permit Regulations - 9VAC25-180-10 et seq.), an Erosion and Sediment Control Plan must be developed, reviewed, and approved by appropriate qualified personnel in accordance with the latest version of IIM LD- 11, and a Stormwater Management Plan must be developed, reviewed, and approved by appropriate qualified personnel in accordance with the latest version of IIM LD- 195.

## PLAN PREPARATION

The sample plan assemblies for both "No Plan" and "Minimum Plan" projects ([See Road Design Manual Volume 2, Metric](#)) provide the manner of showing the minimum essential information and the notes necessary to govern construction. For current versions of these sheets, see the CADD No Plan Directory, which is in Falcon under Engineering Services (eng-ser). Variation may be made to the formats to meet the specific project needs and to best utilize all available sheet space, thereby minimizing the total number of project assembly sheets. Careful attention should be given to the notes shown thereon.

The plan assemblies for both "No Plan" and "Minimum Plan" projects are to be placed in Falcon and transmitted electronically to the Plan Coordination Section in the Central Office. The document assembly instructions are located in Falcon along with the other typical drawings needed for "No and Minimum Plan" projects.

Generally, plan variations from AASHTO guidelines, as set forth in the Geometric Design Standards (See VDOT's [Road Design Manual](#), Appendix A), are not readily apparent in an office review; therefore, it is very important that the variations be defined in the project assembly (consisting of the plan details, Form C-99, cost analysis, and narrative or description of the work) by the **Project Manager** and/or District Administrator.

Aggregate Material No. 21, 21A, 25 or 26 should be set up as a contract item for roadway base or subbase, maintenance of traffic, private entrances, and mailbox turnouts. Normally, one contract item should cover all uses.

## SPECIFICATIONS

It is intended that modified versions of parts of VDOT's [Road and Bridge Specifications](#) will be followed in order to reduce the field engineering and final computations required; however, the use of such modifications must still be consistent with good construction practices in relation to the kind and type of improvement being provided.

A unit price for extra excavation is to be established by the **District Construction Engineer** or the District Administrator's staff and entered on Form C-99 for inclusion in the contract assembly by the contract section.

The Special Provisions for "No Plan and Minimum Plan Projects" (available from VDOT's Scheduling and Contract Division) are approved by the Federal Highway Administration for use on a project by project basis. When additional changes to the Specifications are necessary, such changes should be documented and submitted with the project assembly. (Any additional Special Provisions are to be reviewed by the Scheduling and Contract Division in ample time for inclusion in the project bid proposal.)

"No Plan" and "Minimum Plan" projects will often consist of small quantities of materials; therefore, materials testing requirements for most items will fall within the limits of minimum testing as set forth in VDOT's Materials Manual. Compactive effort must be provided by the Contractor in such a manner as to attain the required densities and random compaction tests will be performed to the extent required to assure proper compaction.

Generally, materials from sources that have proven to be satisfactory in the past will normally be accepted by certification as determined by VDOT's Materials Division, subject to visual inspection at the project site.

The Contractor shall perform all construction surveying on "No Plan" and "Minimum Plan" projects in accordance with the Special Provision "Copied Note" for Section 105.10 of VDOT's (See IIM LD- 152) VDOT's Road and Bridge Specifications.

Prospective bidders may be required to attend the Project Showing as a prerequisite for submitting a bid proposal for "No Plan" and "Minimum Plan" projects. When attendance is required, prospective bidders must register with the Engineer at the project showing and all attending parties are to be noted in the project showing letter. The Project Engineer and the Project Inspector must also attend the project showing. The Field Narrative will indicate if attendance is required.

## **PROJECT LAYOUT**

If deemed necessary by the District Administrator or **District Construction Engineer**, marked stakes shall be established showing the approximate depth at centerline of major fills and cuts which exceed 4 feet and/or other areas as required. Marked stakes shall be in place at the time of the Project Showing.

Survey work for "Minimum Plan" projects should normally be performed in accordance with the VDOT Survey Instructions Manual or as otherwise determined by the District Administrator or **Project Manager**. The designer should determine in the early stages of the plan development where additional survey is needed in order to alleviate any major problem during construction. Normally, on "Minimum Plan" projects, entrance profiles are taken where right of way donations are not anticipated; however, they should not be plotted unless the need for condemnation is required.

## **INSPECTION AND RECORD KEEPING**

Close coordination between the Project Inspector and the Contractor is necessary to assure the success of the "No Plan" and "Minimum Plan" concepts.

Only one loose leaf notebook is normally necessary on a "No Plan" or "Minimum Plan" project and it may be used as a combination diary, materials book, and sketch book provided that electronic versions of these materials are not available.

Alignment and sketches may be entered in accordance with standard procedures or, where feasible, small sketches may be glued into the notebook to properly indicate the work performed.

Where it is determined by the District that "As Built Plans" are more practical, they may be used in lieu of entering alignment, sketches, and summaries in the notebook. When "As Built Plans" are used, any changes, additions, or deletions of any nature are to be clearly indicated on the prints/files furnished to the Inspector with the diary and materials information entered in the notebook.

Upon the completion of a project, all records shall be submitted in accordance with standard procedures; except that after verification of the materials section by the District Materials Engineer, a reproducible copy of the materials section of the notebook/file is to be furnished to the State Materials Engineer in lieu of furnishing the original document/file.

## **SECTION A-8-SEQUENCE OF CONSTRUCTION/MAINTENANCE OF TRAFFIC**

### **INTRODUCTION**

These guidelines serve as a tool to assist the designer in plan preparation. Sequence of construction, maintenance of traffic and constructability are related topics and significantly affect the quality of our plans. Broad issues of constructability and quality control are commented on, however they are not the focus of these guidelines. The purpose is to familiarize individuals with the technique and importance of preparing an adequate sequence of construction and maintenance of traffic plan. Constructability issues concerning sequence of construction and maintenance of traffic are covered. Reference material is located elsewhere in this section and in the Instructional and Informational Memoranda (IIM). References listed at the end of these guidelines provide additional resources and the list of items to consider may serve as a checklist.

As related issues, the sequence of construction and maintenance of traffic are included in one plan. The plan includes diagrams and appropriate notes to inform the contractor of when each operation is to be accomplished. The plan delineates traffic control procedures necessary prior to, during and following construction. The sequence is to be a guide with a step by step procedure from the beginning to the end of construction. It is important to provide the plan in a clear and easy to follow manner. Do not sacrifice plan clarity to reduce pages. The plan is necessary to insure that a project can be built as designed without undue difficulty and with minimum work orders. Developing a sequence of construction and maintenance of traffic plan is an essential part of the overall project design and may affect the design of the facility itself. Design of the proposed improvements should be coordinated with the maintenance of traffic plan. There may be acceptable design alternatives which would improve tie-ins to existing pavement and facilitate significantly smoother flowing sequence of construction and maintenance of traffic.

A plan is necessary for complex projects when construction warrants a step by step explanation of the construction process. Such projects may have high traffic volumes, peak hour traffic backups, major cuts and fills, major drainage structures, bridges, or utility relocations requiring traffic detours or shifts. Begin planning in the very early stage of design and continue to solicit assistance throughout the design process to finalize the plan. Request input at Field Inspection and other appropriate meetings as necessary.

Throughout the design process it is important to keep in view the big picture. Before beginning to prepare a sequence of construction plan, walk or drive the project to become familiar with the project and critical construction areas. Take notes, make sketches, video tape and take pictures to assist in communicating issues to consider.

Develop a draft sequence of construction plan, thinking through each step as it relates to the other steps. These guidelines contain some helpful suggestions and references. Reviewing examples of well prepared sequence of construction plans is an excellent way to learn about the various issues. Brain storm alternative construction sequences to arrive at the most practical. It may be helpful to color code each phase of construction and make a written narrative of each phase.

Seek advice from individuals, sections or other divisions with particular expertise or experience necessary in preparing sequence of construction plans. Methods of obtaining advice include requesting individuals to review a sequence plan or setting up a meeting to discuss concerns and alternative solutions. There is a wealth of knowledgeable and experienced individuals within VDOT to consult when preparing sequence of construction and maintenance of traffic plans.

The road designer should consult and coordinate input from the Scheduling and Contract, Environmental, Asset Management, Materials, Right of Way, Structure and Bridge, Traffic Engineering, and Local Assistance Divisions, the Project Engineer and Inspector throughout the process of developing a sequence of construction and maintenance of traffic plan. It may be appropriate to contact the District and Central Office representatives of referenced Divisions, particularly the District Traffic Engineer. Advantage should be taken of all opportunities to solicit public input concerning the planned sequence of construction and maintenance of traffic. The public commutes the subject area every day and is in a position to point out situations of concern. Evolution of a sequence of construction and maintenance of traffic plan is an ongoing process and modifications will be necessary prior to and during construction as issues surface or difficulties develop.

The road designer is responsible for preparation of the plan for inclusion in the plan assembly. Preparation will involve requesting, coordinating and organizing input from numerous other individuals. The designer is not expected to know all of the traffic control options and construction techniques and other related expertise necessary to prepare a comprehensive plan. The plan should be located in the front portion of the plan assembly, within the 1 series of sheets.

The Location and Design policy concerning sequence of construction and maintenance of traffic plans is as follows:

Preliminary Maintenance of Traffic/Sequence of Construction Plans are to be developed by the roadway designer in the earliest possible stage of plan development and reviewed by the Traffic Engineer prior to Field Inspection.

Maintenance of Traffic/Sequence of Construction Plans should safely and efficiently maintain traffic while providing capacity and operating speed comparable to the typical highway conditions where feasible.

The following note is to be shown on the Maintenance of Traffic/Sequence of Construction Plan:

"Unless otherwise approved or directed by the Engineer, the Contractor shall plan and prosecute the work in accordance with the following:"

The Traffic Engineering Division will determine locations where detailed plans for traffic control devices are required for inclusion in the final Maintenance of Traffic/Sequence of Construction Plan.

Following the Field Inspection, plans are revised to incorporate the District Administrator's Field Inspection recommendations, and prints of updated plans are provided to the Traffic Engineer (Central Office or District). The Traffic Engineer prepares necessary plans for traffic control devices and provides plans to the road designer for inclusion in the construction plan assembly.

The Maintenance of Traffic/Sequence of Construction Plans are reviewed as follows:

1. Quality Review for Field Inspection
2. Field Inspection
  - a. Recommendations from the District Administrator at Field Inspection are submitted to the Location and Design Engineer and copied to the Traffic Engineer.
  - b. After accepted Field Inspection recommendations have been incorporated into the plans, prints are provided to the District Traffic Engineer and State Traffic Engineer for review prior to Public Hearing/Right of Way Stage.
  - c. Detours, right of way, and easements must be completed in sufficient detail for the right of way requirements to be incorporated into Public Hearing/Right of Way plans.
3. Right of Way and Constructability Review
4. Advertisement Quality Review
5. Pre-advertisement meeting

## **SEQUENCE OF CONSTRUCTION**

A sequence of construction plan is to include diagrams and appropriate notes to inform the contractor of when each operation may to be accomplished and advise of traffic control necessary during construction.

Except for the most simple projects, a sequence of construction is necessary. Delays and redesign during construction are often extremely costly, may also cause an unsafe situation and can unnecessarily cause additional disruption of traffic patterns. Our desire is to minimize the inconvenience to the public. To the extent possible, the plan should have flexibility. Recognize that the contractor may, with the Engineer's approval, modify the sequence of construction, but to approach a project without a plan is risky. The sequence may seem simple at first glance but thinking through the steps helps make us aware of possible difficulties. Each project presents unique challenges and developing a sequence of construction offers opportunities to address these concerns at an early stage.

The road designer is responsible for determining the need for barricades and detours during construction. The designer is also to review the plans carefully to determine if it will be necessary to shift traffic lanes away from the normal position during construction and determine required easements. If shifting lanes is necessary, a sequence of construction is to be prepared by the designer with input from the appropriate Assistant Scheduling and Contract Engineers and/or Assistant District Engineer. The sequence of construction plan is to be reviewed by District office representatives and individuals from applicable divisions and agencies at each stage of plan development. The Scheduling and Contract, Environmental, Asset Management, Materials, Right of Way, Structure and Bridge, Traffic Engineering, and Local Assistance Divisions, Project Engineer and Inspector should be consulted concerning their respective areas of responsibility.

When a Sequence of Construction Plan is necessary, it will be included in the plans that are distributed for review at the Field Inspection and it will be of sufficient detail to present the basic concept for discussion and determination of environmental, traffic, safety, and right-of-way requirements. Reviewing examples of well prepared sequences of construction plans is an excellent way to learn about the various issues to be addressed. Examples should address different construction challenges. Discussion should take place at the Field Inspection concerning a narrative if a Sequence of Construction Plan is not necessary. All of the above items are to be discussed thoroughly at the Field Inspection and recommendations included in the Field Inspection Report.



A copy of the sequence of construction plan, with the accepted Preliminary Field Inspection recommendations incorporated, is to be furnished to the Traffic Engineer prior to the Field Inspection/Right of Way stage. If detours, right of way or easements are required for the maintenance of traffic, the sequence of construction must be completed in sufficient detail for the right of way requirements to be incorporated into the Field Inspection /Right of Way plans.

When a sequence of construction plan or narrative is unnecessary for a particular project, the file will be documented accordingly with the listing of the names of those involved in the decision and the reasons for the decision. The field inspection prints must also indicate that a sequence of construction plan or narrative is not necessary and that only such items as flagging, warning lights, etc., will be required.

### **ITEMS TO ADDRESS UNDER SEQUENCE OF CONSTRUCTION:**

Adjoining projects and sequence of construction must be coordinated. There may be occasions where a portion of one project would be more efficiently constructed at a designated stage of the construction sequence of another project. This may apply at intersections or other locations. Surplus material may be utilized from an adjoining project. Section 105 of the Road and Bridge Specifications specifies that there shall be cooperation among contractors on adjoining projects.

Bridge construction should be addressed in the sequence of construction. The coordination of the bridge construction with the roadway portion should be evaluated relative to connecting temporary bridge parapet with the traffic barrier service to insure the proper tie when performing the installations. Bridge construction often requires very large cranes and other large equipment and materials. It is desirable to avoid constructing a bridge in sections. Also avoid setting beams over traffic. Input should be furnished by the Structure and Bridge, Scheduling and Contract and Traffic Engineering Divisions to provide a plan taking these issues into account. Detours may be necessary during periods of bridge construction.

Construction activity: Sequences of construction should be designed to prevent worker activity left and right of traffic at the same time. This situation makes the driver feel restricted, slows traffic and endangers workers. Construction normally takes place on the outside portion of the project and moves in (on major widening or reconstruction projects). Weather and other factors impact the length of construction time. Weather may affect concrete pavement and other concrete construction.

Drainage: Temporary ditches or pipes may be necessary. Replacement of existing drainage may require a temporary diversion ditch or pipe. Jacking versus open cut for pipe causes less interruption to traffic but is normally a considerably more expensive method of pipe installation.

Proposed pipes under roadways with high traffic volumes or difficult detours options are candidates for jacking. New construction and extensions of box culverts require considerable construction time. Urban projects should incorporate precast drainage items as much as practical, since improvements in urban areas are generally adjacent to and performed under traffic. Precast items would reduce worker exposure time to traffic and vice-versa since a precast item can be installed much quicker than a cast in place item. Openings for cross-drain pipes on interstates should be designed to prevent small children and animals from accessing the freeway.

Environmental concerns include avoiding wet lands and seeding disturbed slopes at the earliest appropriate stage of construction.

Excavation and earthwork: The Grading Summary and material hauls must match maintenance of traffic and sequence of construction plans. Consider borrow material versus surplus material at each stage of the sequence. Address locations where surplus material may be placed. Areas of graded slopes may be appropriate locations to waste surplus material. Consider areas of major cut or fill to anticipate slope tie in difficulties. In development of the Grading Diagram and Summary, it is essential that the project sequence of construction be taken into consideration to avoid specifying use of material which is not available in the appropriate phase of construction. On complex projects, it may be necessary for the designer to develop rough grading diagrams and summaries for each phase of work to accurately determine the grading effort required.

Example plans: Review example plans and seek advice from individuals with experience.

Funeral homes and Churches: Construction should be prohibited in the immediate vicinity of funeral homes and churches during services. This is common courtesy and enhances public relations. This consideration will normally be addressed during preconstruction meetings, but may warrant a plan note.

Intersection reconstruction may require a Sequence of Construction/Maintenance of Traffic Plan as these areas may be very involved.

Material hauls: The contractor should plan the transfer of materials and equipment in a manner that minimizes the impact on traffic movement, as much as practical.

Nighttime construction: In order to reduce the disruption of traffic flow and avoid stopping traffic, certain construction activities, such as the placement of bridge beams or overhead sign structures should be accomplished at night. However, additional safety precautions may be necessary when accomplishing this activity.

Note in the plans that the Contractor shall plan and execute the work in accordance with the Sequence of Construction Plan unless a change is approved or directed by the Engineer.

Note in the plans that it is not the intent of the sequence of construction plan to enumerate every detail which must be considered in the construction of each stage, but only to show the general handling of traffic.

Pavement or structure demolition sequence should be considered.

Railroad crossings or construction adjacent to rail lines should be considered. Input should be obtained from the Virginia Department of Rail and Public Transportation concerning special requirements. Avoid situations where traffic signals, road intersections, road grades and etc. could trap vehicles on the tracks.

Sound barrier walls: The sequence of constructing sound barriers should be closely reviewed, especially when located on the shoulder, since access for work vehicles may require a lane closure. Consideration should be given to sound barrier construction at an early stage of the project construction to help shield adjacent areas from noise.

Time of day, holidays or other day and time restrictions may be necessary stating when construction or traffic flow restraints are not allowed. Notes may be necessary stating specific dates/times. Local ordinances such as noise may restrict when work can be performed. Section 105 of the Road and Bridge Specifications specifies restricts Holiday work times unless permission is granted by the Engineer.

Utilities: On some projects utility relocations are complete prior to beginning the road construction. Existing utilities should be addressed in the sequence of construction as to when and by whom they will be relocated. A portion of the road construction may be necessary prior to installing or relocating utilities.

Walk or drive the project: Take pictures, notes, video and make sketches. This process will help in recalling and conveying to others the areas of concern.

## **MAINTENANCE OF TRAFFIC**

A maintenance of traffic plan is necessary to insure that motorists, pedestrians and construction workers can safely travel or perform their jobs during roadway construction.

A well-thought-out and carefully developed plan will contribute significantly to the safe and expeditious flow of traffic as well as the safety of the construction forces. The goal of any maintenance of traffic plan should be to safely route vehicle, bicycle, worker and pedestrian traffic, including persons with disabilities, through or around construction areas.

Geometrics and traffic control devices should operate in a manner comparable to the existing operating situation while providing room for the contractor to work effectively. A maintenance of traffic plan informs the contractor in writing as to how we expect the traffic to be maintained throughout the project and how the summaries have been worked up. The plan may constitute a traffic maintenance sequence and include drawings and diagrams to convey instructions. Traffic flow arrows are recommended.

It is advantageous to prepare and evaluate the maintenance of traffic plan from the motorist's point of view. We have all been delayed in traffic due to road construction. Many times it is unavoidable. Preparing an efficient maintenance of traffic plan is one way we can better serve the public. It has been said that the shortest distance between two points is always under construction. This may be the public's perception when they are inconvenienced. Imagine how a driver would view the plan in operation.

Realize that there may be an element of surprise or uncertainty for the driver, who will likely be unfamiliar with the revised traffic pattern and hazards. The maintenance of traffic plan must be coordinated with the sequence of construction. Reviewing examples of well prepared maintenance of traffic plans is an excellent way to learn about the various issues to be addressed. The examples should address different construction challenges. Do not hesitate to seek advice from Divisions, sections or individuals with expertise or experience in preparing a maintenance of traffic plan, particularly the District Traffic Engineer.

Maintaining a safe flow of traffic during construction must be carefully planned and executed. Although it is often better to provide detours, frequently it will be necessary to maintain the flow of traffic through the construction area. Construction areas are protected by barriers, appropriate speed limits, channelizing devices, signs, signals, lighting, impact attenuators, truck mounted crash cushions and flagging to provide safe traffic control during construction. Construction area devices may include variable message signs or divided highways. Sometimes it will also be necessary to encroach on the through-traffic lanes or shift lanes entirely in order that the construction can be undertaken. When this is necessary, designs for traffic maintenance should produce as minimal an effect as possible on normal traffic flow. The plan depends on the nature and scope of the improvement, volumes of traffic, highway or street pattern, and capacities of available highways or streets. The plan should have some built-in flexibility to accommodate unforeseen changes in work schedule, delays, or traffic patterns.

Adequate advance warning and sufficient follow-up information are needed for the motorist. Standards for the use and application of signs and other traffic control devices when highway construction occurs are set forth in Part VI of the Federal Highway Administration's Manual on Uniform Traffic Control Devices, MUTCD. Designs for the use and application of signs and other traffic control devices are developed by the Traffic Engineering Division of VDOT. Traffic control devices instructions published by the Traffic Engineering Division are included in The Virginia Supplement to the Manual on Uniform Traffic Control Devices.

Part VI of the Virginia Supplement was modified and reproduced as a separate publication, Virginia Work Area Protection Manual. Location and Design is responsible for the design of the facilities (except bridges) to accommodate the traffic.

The stopping of public traffic by a flagger or any other means should be avoided where possible and should be approved by the District Administrator. Designs that provide for constant movement around an obstruction in the roadway, even if it is slow, are more acceptable and are less irritating to drivers than requiring them to stop. Construction operations frequently create the need for adjustments in traffic patterns including the shifting of lanes.

Splitting traffic in the same direction on both sides of construction is not acceptable. The minimum taper length for lane transitions in construction areas can be computed by a formula found in the MUTCD. Various configurations are illustrated in the MUTCD and should be used in developing maintenance of traffic plans.

Designed shifts in traffic flows are to conform to the geometrics shown in the standards for detours (Standard GS-10) and/or as indicated in the "Safety Guidelines for Construction Zones" (See IIM LD- 93).

Depending on various project conditions, the Traffic Engineering Division may recommend one of the following methods of maintaining traffic for a project.

A. Under the following circumstances a simple sequence would normally be used:

1. If the Average Daily Traffic volume (ADT) is 1000 or less.
2. If there are no pipes that are 48" (1200 mm) or greater in diameter.
3. If there are no double lines of 24"(600 mm) pipe or greater.
4. If there are no major drainage structures.
5. If no major off-site detours are required.
6. If there are no major utility relocations required.

A simple sequence may read:

"Traffic is to be maintained throughout the project on the present road or on the grade where the present road is to be raised or lowered. Short periods of one-way, flag controlled traffic may be allowed at the option of the Engineer."

B. Under the following conditions a simple sequence requiring time restrictions should be considered, but keep in mind that these are only meant to be used as general guidelines. Time restrictions may not be necessary in all of the following situations:

1. If the ADT is 1000 or more and could present a problem with peak-hour traffic backup;
2. If there are pipes larger than 48"(1200 mm) in diameter;
3. If there are double lines of 24"(600 mm) pipe or larger.
4. If there are major drainage structures.

A simple sequence with "time" restrictions may read:

"Traffic is to be maintained throughout the project on the present road or on the grade where the present road is to be raised or lowered with a minimum lane width of \_\_\_\_\_. Two-way traffic is to be maintained between the hours of \_\_\_\_: a.m. to \_\_\_\_:\_\_\_\_ p.m. weekdays, and at all times on Saturdays, Sundays and Holidays, unless otherwise directed by the Engineer."

- C. A more in depth sequence or an off-site detour may be required in situations where neither of the simple sequences listed above are appropriate. This may require a step by step description of the sequence.

When construction operations are scheduled to take place adjacent to passing traffic, a clear zone should be called for in the plans between the work and the passing traffic. Under most conditions, positive barriers or time restrictions are justified.

#### **ITEMS TO BE ADDRESSED UNDER MAINTENANCE OF TRAFFIC INCLUDE:**

Access to adjacent residential and commercial properties should be maintained at all times. Maintenance of traffic and sequence of construction notes should reflect this policy and emphasize the requirement at fire stations, emergency rooms and other emergency facilities. Section 104 of the Road and Bridge Specifications specifies that entrances shall be maintained.

Asphalt medians: Temporary medians should be considered where construction creates situations with new traffic patterns for motorists. This channelizing will provide improved safety by forming a positive separation of opposing traffic.

Barrier, attenuator service and truck mounted attenuator guidelines and standards are contained in the Construction Zone Safety IIM LD-93. Engineering Services will be contacted to design the Impact Attenuators. The location of drums, barriers, or barricades, as means of channelizing traffic, should be detailed in the maintenance of traffic plans when special conditions exist. Channelizing devices are addressed in the Virginia Work Area Protection Manual (Page 50). Concrete barrier placement is important. There will be instances when construction access in runs of traffic barrier service will be necessary for the contractor to access with materials and equipment. These locations should be reviewed to determine if attenuators or a transition is needed, or time restrictions and use of surface treatment to prevent debris on public travelway. Runs of traffic barrier should be properly transitioned on either end, in the clear zone, as indicated in the Virginia Work Area Protection Manual, for the operating speed during construction. Otherwise, temporary impact attenuators will be required. Applicability of Quickset Barrier System; use of Quick Change barriers may facilitate

changing the number of lanes during rush hour. There may be times when it is practical to implement the Quick-change Traffic Barrier System to maintain roadway capacity in

the AM and PM peak hours, yet provide additional work space for specific work activities during off-peak times. The NEAT attenuator system is an end treatment for temporary work zones which has FHWA approval for use on these barrier systems.

Bridges; Temporary bridges may be cost effective for reconstruction of existing bridges.

Bridge rails, existing: In many instances, existing bridges do not have the accepted approach guardrail runs and terminal treatments. Due to the unusual and distracting work techniques used in bridge construction that may be in the immediate vicinity of traffic during the erection of the proposed structure, maintaining traffic on the existing structure may require guardrail, at least on the right side of approaching traffic to eliminate run off the road or fixed object impacts by an errant motorist.

Clear zone: Clear zone requirements should be maintained and the contractor should be instructed to maintain the clear zone free of stored materials and parked equipment as much as practical.

Construction equipment: Idle construction equipment must not impact sight distances at intersections and especially in school zones or entrances. When the construction site is in the vicinity of an airport, consideration should be given to include a note on the plans that the contractor shall be responsible to insure construction equipment does not violate Federal or airport clearance regulations.

Coordinate work: There may be times that several contractors are working in the same vicinity. During these times advanced work zone signing should be coordinated to insure driver expectancy is not compromised by the placement of unnecessary or conflicting signing.

Detours may be necessary to provide the smoothest and safest traffic flow around work zones. If a temporary detour is shown in the traffic control plan, it should be graphically indicated in the plan assembly, with the proper directional advanced signing for the contractors guidance prior to initiating work activities. Address issues of alignment, grade, length, width, pavement strength, truck restrictions, detour capacity for rerouting traffic, detour quantities (including grading, drainage, pavement, etc.) and a detour removal detail (with pay items). Temporary detour grades are necessary where such grades are not obvious such as paralleling existing pavement. When shoulders are used as a detour, the pavement width and strength should be reviewed to accommodate the appropriate vehicle loads.

Detour operating speed should approximate existing highway operating speed (every attempt should be made to not reduce the speed by more than 10 mph (16 km/h)). Attention should be given to maintaining emergency (fire, etc.) vehicle, bus and mail

routes. It may be appropriate to request District input, research or communication with the fire department, school authorities and other authorities concerning the maintenance of traffic patterns. Include traffic items provided by the District Traffic Engineer.

**Edgeline markings:** A one foot (0.3 m) offset should be provided between the face of traffic barriers and the edgeline marking. This provides some lateral distance for distracted or crowded drivers to maneuver if needed.

**Emergency access:** During construction of roadway improvements and especially one lane maintenance projects and bridge projects, construction and flagger crews should be alert to the access needs of fire, rescue and police vehicles in the vicinity. Safety of the workers and public on the project and elsewhere is of primary importance.

**Glare screens:** Consideration should be given to using glare screens where practical, and when sight distances will not impact merging motorists. Glare screens reduce motorists distractions to worker activity behind the traffic barrier service and may result in a better quality product since workers would not be distracted by traffic.

Also, reducing distractions will enhance safety, improve traffic flow and decrease rubber-necking.

Grades are important to consider when establishing maintenance of traffic. Vertical and horizontal alignment must be considered. Design alternatives for the vertical and horizontal alignment of the proposed improvements should consider the maintenance of traffic plan. There may be acceptable design alternatives which would improve tie ins to existing pavement and facilitate a significantly smoother flowing sequence of construction and maintenance of traffic. Detours, material haul roads, temporary access locations and road connections must be vertically and horizontally evaluated. Also, insure that required construction fill will not encroach on existing travel way and maintained traffic while constructing deep cuts and high fills. When sheet piling is necessary, it requires subsurface investigation.

Grading diagram coordination is important with the maintenance of traffic plan. Plan the traffic plan to facilitate implementation of the grading diagram.

Guardrail laps should be switched when traffic flow is reversed for a significant length of time.

**Highway advisory radio:** Interstate improvements may warrant the need for highway advisory radio broadcast, to provide advanced warning to motorists that delays should be expected unless the suggested alternate route is used.



**Impact attenuators:** These are required at the introductory locations of traffic barrier service, unless the traffic barrier can be transitioned as indicated in the Virginia Work Area Protection Manual. Engineering Services will be contacted to design the Impact Attenuators.

**Lane closures:** When lane closures are proposed in the traffic control and sequence of construction plan, the use of electronic arrowboards and variable message signs should be addressed. This subject is normally addressed at Field Inspection by the Traffic Engineer.

**Lanes, number of:** While it may not always be possible to provide the same number of lanes that were available prior to initiating construction activities, the same number of lanes should be provided during peak hours. Lane restrictions may not be appropriate during certain periods and this should be noted on the plan.

**Lane shifting:** Lane shifting should be designed to accommodate the operating speed for the particular work zone. When these areas are on 4 lane divided facilities and the operating speed is considerably high, the proper superelevation is imperative. Also, the adequate horizontal and vertical alignment must be available to maintain driver expectancy and should not be designed for more than a 10 mph (16 km/h) speed reduction than that of the remainder of the work zone.

**Lane widths:** Adequate lane widths should be available. Geometric Design Standards in the front of Appendix A of the Road Design Manual specify lane widths. Lane widths should be a minimum of 11' (3.3 m) and in minor work zones 10' (3.0 m). When determining lane widths, the percent of truck traffic should be considered.

**Navigable streams:** Advanced up and down stream signing should be provided for sportsmen, canoeist and fishermen when overhead construction activities are required for bridge placement over navigable streams.

**Pavement design** should incorporate existing pavement when practical. Pavement design should consider temporary markings, so proper courses may be specified at appropriate construction stages. Milling may excessively weaken existing road pavement strength, such as at bridge approaches and the Materials Division should be consulted for appropriate instructions.

**Pavement markings** for temporary use may be covered with the final pavement course. Details should provided for any special pavement marking requirements. Pavement marking eradication information is in IIM LD- 93. Temporary pavement markers should be considered to provide more positive guidance at nighttime and during inclement weather.

Pavement surface within the construction and detour areas should be maintained in a condition that will permit the safe movement of traffic at a reasonable speed.

Peak traffic hour work: The maintenance of traffic plan should direct the contractor not to perform work which would impede the flow of traffic during peak hours of traffic congestion, holidays, etc.

Pedestrian traffic must be maintained. The maintenance of traffic plan should accommodate pedestrian traffic as well as automobile traffic, particularly in urban areas.

Phases: Engineering studies indicate work zone lengths should not exceed 0.5 mile (0.8 km) in length. Research in work zones indicates an increase in accident rates when motorists are subjected to extended travel times adjacent to work zone activities. Consideration should be given to constructing the facility in phases containing 0.5 mile (0.8 km) work zone lengths, where practical. There may be situations with minimal driver distractions and inconvenience where a work zone should be as much as two miles in length.

Railway crossings must be considered. Avoid designs where traffic signals, road intersections, road grades and etc. could trap vehicles on the tracks. This was also mentioned under sequence of construction.

Right of way or temporary construction easements may be required for construction or temporary detours: Sheet piling may be more economical in some situations.

Safety issues are always of paramount importance. They encompass more items when maintaining traffic through a construction site because safety of the workers is an additional element. The worker is often protected only by the barriers or other features of the maintenance of traffic plan.

Shoulders: In relatively long work zone areas, the construction of an adequate shoulder is desirable, to provide lateral placement of stalled or disabled vehicles beyond the travel lanes.

Sight distance: Adequate vertical and horizontal sight distance must be maintained for safety reasons.

Signalization, temporary and permanent: Existing and proposed pole locations must be taken into account. Signal timing: When construction activities, such as resurfacing, require the closure of an existing lane, it may be necessary to lengthen the green time for that leg. This would help retain the capacity of the intersection.

The State Traffic Engineer is responsible for preparation of the sign, signal and lighting plans. Temporary traffic signalization may be required at some locations for construction purposes. They will require detailed plans, just as permanent signals.

Signs with variable messages: Due to terrain or inclement weather, the use of passive signing may not be enough to maintain the desired element of safety. It may be appropriate to install variable message signs to attract the driver's attention when approaching a changing traffic pattern.

State police: There may be certain roadway improvements where the worker is adjacent to motorists and there is a danger of automobile encroachment into the work area. These projects may require the participation of state police for the enforcement of posted speed limits within the work zone. See State Police Participation in IIM LD- 93. Interstate roadway improvements may warrant an increase in the number of existing safety patrols to reduce delays and provide assistance to stranded motorists within the travel lanes.

Stubs should be designed where appropriate to facilitate improved maintenance of traffic for future road extension. Pavement stubs and "tie-in" construction should be addressed in the maintenance of traffic plan.

Tapers are needed for lane drops or at locations where traffic must be shifted laterally. Appropriate values for taper lengths can be found in Part VI of the MUTCD.

Traffic volume capacity: Attempt to maintain the traffic volume capacity of existing roads.

Turn lanes should be maintain (left and right).

Utility adjustment must be accommodated.

Wrecker service: Some work zones, mainly on limited access facilities, may require the implementation of 24 hour wrecker availability for the towing of disabled vehicles.

**NOTES WHICH MAY BE APPROPRIATE ON MAINTENANCE OF TRAFFIC AND SEQUENCE OF CONSTRUCTION PLANS INCLUDE:**

(These notes should be developed in coordination with the District Traffic Engineer)

Unless otherwise approved or directed by the Engineer, the contractor shall plan and prosecute the work in accordance with the following sequence of construction and maintenance of traffic plan and this shall be coordinated with the bridge plans.

It is not the intent of the sequence of construction plan to enumerate every detail which must be considered in the construction of each stage, but only to show the general handling of traffic.

All areas excavated below existing pavement surface and within the clear zone, at the conclusion of each workday, shall be back filled to form an approximate 6:1 wedge, against the existing pavement surface for the safety and protection of vehicular traffic. All cost for placing, maintaining and removing the 6:1 wedge shall be included in the price bid for other items in the contract and no additional compensation will be allowed.

Traffic barrier service shall be installed and removed so as not to present any blunt end or hazard to the motoring public. The placement and removal of the traffic barrier service and barricades are to be coordinated by the Project Safety Officer.

**LIMITATION OF OPERATION** notes may include:

The following restrictions will apply, except in cases where the Engineer determines they are not in the best interest of the Department and/or the traveling public.

Traffic shall not be detained on route \_\_\_\_\_ for longer than five minutes at any time, unless directed by the Engineer.

Closing of traffic lanes or shoulders is only permitted between 10:00 P.M. and 6:00 A.M. Monday through Friday.

No lane restrictions will be permitted from 12:00 Noon Friday until 9:00 A.M. Monday and during the following period: 6:00 A.M. Dec. 23, 2006 through 7:00 P.M. Jan. 3, 2007;

Note concerning southbound traffic may read: All travel lanes shall be open between the hours of 4:00 P.M. and 6:00 P.M. Monday through Friday. One travel lane may be closed all other times with the exception of dates listed below.

## **CONSTRUCTABILITY**

Constructability relates to whether the project can be constructed as designed with the information shown in the plans. Many of the necessary items to consider when determining the constructability of a project are included in the Road Design Manual's Quality Control Checklist.

There is a huge advantage in having a construction expert review the concept of a project before even preliminary plans begin. A construction expert can review the proposed project and what it is intended to achieve, the proposed location of a project, the duration for design and construction and various design alternatives. This review should involve a dialogue with the design leaders of the project.

The construction expert will look at the proposed project through the eyes of the constructor and will consider the advantages and disadvantages of the potential design alternatives. There should be a review of the site and of the surrounding areas.

Geology, topography, accessibility, utilities, existing infrastructure, businesses, residences, etc., should be examined from the contractor's perspective. Potential strategies likely to be adopted by the contractors to deal with all these site issues should be discussed with the design team to see how the design might be developed to dovetail with strategies that are beneficial to the contractors and the local population in the prosecution of the project.

The review may go several miles beyond the environs of the project to examine access for large equipment.

There are issues that can impact design decisions and should be examine early. It provides the opportunity for the designer to begin design with certain key issues in mind which can frequently be accommodated in the design without adverse cost impact to the design. It is not that constructability issues drive the design but that design accommodates constructability in its evaluation. This is much better than trying to inject constructability into the design later.

The construction expert should have a broad knowledge of construction in several fields, not just highways and bridges, together with an understanding of, and empathy with, both the designer and the constructor. Constructability is more than simply making life easier for the contractor. It is the incorporation of construction expertise into the design process so that it will meet all of the design requirements, including aesthetics, at the lowest reasonable cost of construction.

A construction expert will have this broad expertise, together with the ability to work cooperatively and sympathetically with the design team and to respect the integrity of their design. In this way, the constructability review process becomes a team operation where the constructability resource and the design team work together cooperatively to integrate constructability into the design process.

#### **ITEMS TO BE ADDRESSED UNDER CONSTRUCTABILITY INCLUDE:**

Access to adjacent residential and commercial properties should be maintained at all times.

Contractor operations: Adequately evaluate and explain appropriate construction task and operations. This may include the order of construction activities.

Drainage issues: Drainage network errors have had the largest dollar impact and account for 25% of total errors on plans; last minute design changes to the roadway plans, which often require adjustments to the drainage plans, caused many of these errors. Check inverts of culverts and systems to insure positive drainage and outfall. Utility conflicts can significantly affect the sequence of construction. Address the need for temporary drainage for construct, detours, slope drains, etc. (IIM LD-11).

Easements and right of way must be sufficient to construct Project. Few issues can cause more construct delay than the lack of necessary easements or right of way.

Environmental issues: These are issues that can cause more construction delay or unexpected cost. Environmental Division representatives will provide guidance on these issues such as permits required for construction in live streams or concerning wetlands.

Equipment necessary such as piers, cranes, etc.: Adequate equipment clearance such as a crane swing radius is a constructability issue, for safety and functional reasons. Large equipment deserves special consideration as to how it will be transported to the job site and to provide adequate maneuvering clearance during construction. The Scheduling and Contracts Division is a source for advice.

Excavation near existing structures: One issue may be a question of providing adequate horizontal distance to maintain the integrity of existing structures. A subsurface investigation may be appropriate for some locations. The Scheduling and Contract Division is a source for advice.

Materials supply: Consider where and how materials may be supplied to the project. Consider what form of transportation may be utilized to transport material to the job site.

Picture how each aspect of the project will be constructed from the beginning as it would look in the field rather than from plan view.

Plan information: Provide comprehensive plan information for construction of the project.

Plan views, profiles and cross sections must agree.

Precast versus cast-in-place structures should be addressed when appropriate.

Quantity summaries must be complete.

Right of way and easements must be adequate to construct project, store material and operate equipment. Signing, lighting, signalization and other issues present possible needs for additional easements or right of way.

Utility conflicts and relocations can significantly affect project construction schedules.

## **REFERENCES:**

Guidance concerning sequence of construction, maintenance of traffic and their impact on constructability are found in the following references:

### Road Design Manual:

- |       |  |
|-------|--|
| 1E- 1 | Quality Control and Checklist                      |
| 2D-24 | Pavement Termination                               |
| 2E-11 | Traffic Barriers - Guardrail and Concrete Barriers |
| 2E-74 | Safety Items and Sequence of Construction          |
| 2G-11 | Temporary Detours                                  |

## **INSTRUCTIONAL AND INFORMATIONAL MEMORANDA:**

- LD- 11 Erosion and Sediment Control, construction entrances
- LD- 93 Construction Zone Safety
- LD-138 Earthwork Quantities, Sheet 3 (first paragraph)
- LD-173 Construction Access, Temporary Construction Causeway Design
- LD-213 Pavement Markings, Construction Signs, Type III Barricades,  
Insertable Sheets to be included in applicable plan assemblies

### Road and Bridge Standards:

Standard GS-10, Minimum Design Criteria for Temporary Detours

### Road and Bridge Specifications:

Section 104, Scope of Work and Section 107, Legal Relations and Responsibility to the Public

The Federal Highway Administration's Manual on Uniform Traffic Control Devices, MUTCD

The Virginia Supplement to the Manual on Uniform Traffic Control Devices

The Virginia Work Area Protection Manual replaces Part VI of the Virginia Supplement to the Manual on Uniform Traffic Control Devices

## **SEQUENCE OF CONSTRUCTION AND MAINTENANCE OF TRAFFIC ITEMS TO CONSIDER**

### **A. SEQUENCE OF CONSTRUCTION**

- (Items to Consider)
- Adjoining projects
- Bridge construction
- Construction activity
- Drainage
- Environmental concerns
- Excavation and earthwork
- Example plans



Funeral homes and Churches  
Intersection reconstruction  
Material hauls  
Nighttime construction  
Note in the plans  
Pavement demolition  
Railroad crossings  
Sound barrier walls  
Time of day, holidays or other time restrictions  
Utilities  
Walk the project; take notes, make sketches and take pictures and videos.

**B . MAINTENANCE OF TRAFFIC**

(Items to Consider)

Access to adjacent properties  
Asphalt medians, temporary  
Barrier and attenuator service  
Bridge rails, existing  
Clear zone  
Construction equipment  
Coordinate work  
Detours  
Edgeline markings  
Emergency access  
Glare screens  
Grades  
Grading diagram  
Guardrail laps  
Highway advisory radio  
Impact attenuators  
Lane closures  
Lanes, number  
Lane shifting  
Lane widths  
Navigable streams  
Pavement design  
Pavement markings  
Pavement surface

## **MAINTENANCE OF TRAFFIC**

(Items to Consider)

-continued-

Peak traffic hour work  
Pedestrian traffic  
Phases  
Railroad crossings  
Right of way and easements  
Safety issues  
Shoulders  
Sight distance  
Signalization  
Signs with variable messages  
State police  
Stubs  
Tapers  
Temporary grade separation  
Traffic volume capacity  
Turn lanes  
Utility adjustment  
Wrecker service

## **C. CONSTRUCTABILITY**

(Items to Consider)

Contractor operations  
Drainage  
Easements and right of way  
Environmental  
Equipment  
Excavation  
Materials  
Picture each aspect  
Plan  
Plan/profiles/cross sections agree  
Precast versus cast-in-place  
Quantity summaries  
Signing, lighting, signalization  
Utility conflicts