

APPENDIX A

SECTION A-1-GEOMETRIC DESIGN STANDARDS

| | |
|--|------|
| Introduction | A-1 |
| Flexibility In Design | A-1 |
| Secondary Project Improvements | A-2 |
| Roadway Width | A-3 |
| Design Speed (V)..... | A-3 |
| Operating Speed | A-7 |
| Posted Speed..... | A-7 |
| Design Waivers | A-8 |
| Design Exceptions..... | A-8 |
| Functional Classification..... | A-8 |
| Lane/Shoulder/Pavement Transitions, Merging Tapers & Speed Change Lengths | A-10 |
| Geometric Design Standards For Rural Principal Arterial System (GS-1)..... | A-11 |
| Geometric Design Standards For Rural Minor Arterial System (GS-2)..... | A-12 |
| Geometric Design Standards For Rural Collector Road System (GS-3) | A-13 |
| Geometric Design Standards For Rural Local Road System (GS-4)..... | A-14 |
| Geometric Design Standards For Urban Principal Arterial System (GS-5)..... | A-15 |
| Geometric Design Standards For Urban Minor Arterial Street System (GS-6)..... | A-16 |
| Geometric Design Standards For Urban Collector Street System (GS-7) | A-17 |
| Geometric Design Standards For Urban Local Street System (GS-8) | A-18 |
| Geometric Design Standards For Service Roads (GS-9)..... | A-19 |
| Geometric Design Standards For Interchange Ramps (GS-R) | A-20 |
| Geometric Design Standards For Temporary Diversion (GS-10) | A-21 |
| Geometric Design Standards For Shoulder Design (GS-11)..... | A-22 |
| Geometric Design Standards For Shoulder Design For Local Road & Streets (GS-12)..... | A-23 |
| Geometric Design Standards For Graded Median Design (GS-13) | A-24 |

SECTION A-2-CLEAR ZONE/LATERAL OFFSET GUIDELINES

| | |
|---|------|
| Introduction | A-25 |
| Roadways with Shoulders | A-25 |
| Roadways with Curb | A-26 |
| Clear Zone Cost-Effectiveness Analysis | A-30 |
| Embankment Slopes | A-31 |
| Horizontal Curve Adjustments..... | A-32 |
| Showing Clear Zones/ Lateral Offsets on Typical Sections..... | A-33 |
| Non-Recoverable Parallel Slopes | A-35 |

SECTION A-3-TRAFFIC BARRIER INSTALLATION CRITERIA

This Information Is Now Located In Appendix I In The Road Design Manual.

SECTION A-4-GUIDELINES FOR RRR PROJECTS

| | |
|---|------|
| Objective | A-38 |
| Authority | A-38 |
| Definitions | A-39 |
| Project Selection | A-40 |
| Eligibility | A-40 |
| Accident Records | A-41 |
| Bridge Rehabilitation or Replacement Selection Policy | A-41 |
| Environmental Considerations | A-42 |
| Access Control | A-42 |
| Project Development | A-42 |
| Roadway and Travelway Widths | A-42 |
| Design Traffic Volumes | A-43 |
| Design Speed | A-43 |
| Terrain | A-44 |
| Safety | A-44 |
| Geometric Design Criteria | A-47 |
| Clear Zones and Slopes | A-48 |
| Grades | A-48 |
| Crest Vertical Curves | A-48 |
| Sag Vertical Curves | A-48 |
| Stopping Sight Distances | A-49 |
| Horizontal Curves | A-49 |
| Pavement Cross Slope | A-50 |
| Superelevation Requirements | A-50 |
| Pavement Edge Drop | A-50 |
| Intersections | A-50 |
| Design Exceptions | A-51 |
| Planning Drainage Design Elements | A-51 |
| Replacement or Rehabilitation of Drainage Elements | A-51 |
| Hydraulic Characteristics | A-52 |
| Safety Improvements Relative to Drainage Design | A-53 |
| Bridge Restoration | A-53 |
| Bridge Rehabilitation | A-53 |
| Culvert Replacement | A-54 |
| Culvert Rehabilitation | A-54 |
| Culvert Extensions | A-55 |
| Signing, Signals and Pavement Markings | A-55 |
| Plan Reviews | A-55 |
| Public Involvement | A-56 |
| Right of Way | A-56 |
| Utilities (Underground and Overhead) | A-56 |
| Tort Liability and Geometric Design | A-56 |
| Background on Tort Liability | A-57 |
| RRR Improvements and Tort Claims | A-57 |
| Susceptibility of RRR Projects and Standards to Tort Claims | A-57 |
| Defense of a RRR Project Design | A-58 |
| RRR Notes on Project Title Sheet | A-59 |
| Preventive Maintenance (PM) Projects / RRR Projects Utilizing Federal Funding on National Highway System (NHS) Roadways | A-59 |

SECTION A-5-BICYCLE AND PEDESTRIAN FACILITY GUIDELINES

| | |
|--|-------|
| VDOT Policy to Improve Bicycle and Pedestrian Access | A-64 |
| Bicycle Access Facilities | A-66 |
| Existing Roads | A-67 |
| Major Developments and Site Plans | A-67 |
| Selecting Roadway Design Treatments to Accommodate Bicycles | A-68 |
| VDOT/AASHTO Design Guidelines..... | A-76 |
| Shared Roadways | A-77 |
| Signed Shared Roadways..... | A-79 |
| Bike Lanes | A-79 |
| Shared Use Paths | A-82 |
| AASHTO Approved Interstate Bicycle Routes..... | A-98 |
| Resources | A-99 |
| Trails and Trailheads..... | A-101 |
| Rails – With – Trails | A-104 |
| Curb Ramp and Pedestrian Access Route Goals and Objectives..... | A-106 |
| Miscellaneous Notes | A-107 |
| Guidelines For Curb Ramp Locations | A-107 |
| Curb Ramp Elements and Types | A-108 |
| Ramp..... | A-108 |
| Landing | A-108 |
| Perpendicular Curb Ramp (CG-12, Type A)..... | A-109 |
| Parallel Curb Ramp (CG-12, Type B)..... | A-110 |
| Combined (Parallel & Perpendicular) Curb Ramp (CG-12, Type C) | A-111 |
| Pedestrian Access Route | A-111 |
| New Construction..... | A-112 |
| Technically Infeasible | A-112 |
| Alterations | A-113 |
| Procedure For Determining The Location & Design of Curb Ramps..... | A-114 |
| Guidelines For Alterations | A-114 |
| Alteration (Retrofit) CG-12 into Existing Curb and Gutter and/or Sidewalk Locations | A-115 |
| Curb Ramp Application Details | A-116 |
| One Curb Ramp Shall Be Provided For Each Direction of Intersection Crossing, Where Feasible. (CG-12, Type A, B or C) | A-116 |
| Diagonal Curb Ramp..... | A-117 |
| Public Right of Way..... | A-121 |
| Buffer Strip | A-122 |
| Sidewalks | A-123 |
| Sidewalk Transition From Roadway onto Bridge..... | A-128 |

SECTION A-6 AIRPORT CLEARANCE REQUIREMENTS

| | |
|---|-------|
| Associated City Public-Use Airport..... | A-131 |
|---|-------|

SECTION A-7-"NO PLAN" AND "MINIMUM PLAN" PROJECTS

General ConceptsA-133
Public Hearing and Right of WayA-134
Special Design Structures, Soil Survey and Pavement Design.....A-136
Mobilization and Field OfficeA-136
Drainage Facilities and Erosion and Sediment Control MeasuresA-136
Post Construction Stormwater Management Plan and VSMP Construction PermitA-137
Contract Time LimitA-137
Procedures.....A-137
Project Scoping Field Review.....A-137
"No Plan" ProjectsA-138
"Minimum Plan" ProjectsA-140
Permits and Reviews ("No Plan" and "Minimum Plan" Projects)A-142
Plan PreparationA-142
SpecificationsA-143
Project LayoutA-144
Inspection and Record KeepingA-144

SECTION A-8-SEQUENCE OF CONSTRUCTION/ TRANSPORTATION MANAGEMENT PLANS (TMP)

IntroductionA-166
Sequence of ConstructionA-169
Items to Address Under Sequence of Construction:A-170
Temporary Traffic Control PlansA-172
Items to be Addressed Under Maintenance of Traffic Include:.....A-175
Notes Which May Be Appropriate on Temporary Traffic Control and Sequence of Construction Plans Include:.....A-181
Constructability.....A-182
Items to be Addressed Under Constructability Include:.....A-183
References:.....A-184
Sequence of Construction and Temporary Traffic Control Items to ConsiderA-185
A. Sequence of Construction.....A-185
B. Temporary Traffic ControlA-186
C. ConstructabilityA-187

LIST OF FIGURES

| | |
|--|-------|
| Figure A-1-1 Geometric Design Standards For Rural Principal Arterial System (GS-1)..... | A-11 |
| Figure A-1-2 Geometric Design Standards For Rural Minor Arterial System (GS-2)..... | A-12 |
| Figure A-1-3 Geometric Design Standards For Rural Collector Road System (GS-3) | A-13 |
| Figure A-1-4 Geometric Design Standards For Rural Local Road System (GS-4)..... | A-14 |
| Figure A-1-5 Geometric Design Standards For Urban Principal Arterial System (GS-5) | A-15 |
| Figure A-1-6 Geometric Design Standards For Urban Minor Arterial Street System (GS-6)..... | A-16 |
| Figure A-1-7 Geometric Design Standards For Urban Collector Street System (GS-7) | A-17 |
| Figure A-1-8 Geometric Design Standards For Urban Local Road System (GS-8) | A-18 |
| Figure A-1-9 Geometric Design Standards For Service Roads (GS-9)..... | A-19 |
| Figure A-1-10 Geometric Design Standards For Interchange Ramps (GS-R) | A-20 |
| Figure A-1-11 Geometric Design Standards For Temporary Detours (GS-10) | A-21 |
| Figure A-1-12 Geometric Design Standards For Shoulder Design (GS-11)..... | A-22 |
| Figure A-1-13 Geometric Design Standards For Shoulder Design For Local Road and Streets (GS-12) | A-23 |
| Figure A-1-14 Geometric Design Standards For Graded Median Design (GS-13) | A-24 |
| Table A-2-1 Clear Zone Distances (In Feet From Edge of Driving Lane)..... | A-27 |
| Figure A-2-1 Clear Zone (Lateral Offset) Cases | A-28 |
| Figure A-2-1A Clear Zone (Lateral Offset) Cases | A-29 |
| Figure A-2-2 Cost Effective Selection Procedures..... | A-31 |
| Table A-2-2 Horizontal Curve Adjustments | A-32 |
| Figure A-2-4 Example of a Parallel Embankment Slope Design | A-34 |
| Table A-4-1 Geometric Design Criteria | A-47 |
| Table A-5-1 Group A Bicyclists, Urban Section, No Parking | A-71 |
| Table A-5-2 Group A Bicyclists, Urban Section, With Parking | A-72 |
| Table A-5-3 Group A Bicyclists, Rural Section | A-73 |
| Table A-5-4 Group B/C Bicyclists, Urban Section, No Parking | A-74 |
| Table A-5-5 Group B/C Bicyclists, Urban Section, With Parking | A-75 |
| Table A-5-6 Group B/C Bicyclists, Rural Section..... | A-76 |
| Figure A-5-1 (1) Bike Lane With on Street Parking | A-78 |
| Figure A-5-1 (2) Parking Permitted Without Parking Stripe or Stall..... | A-79 |
| Figure A-5-2 (2) Typical Bike Lane Cross Sections | A-80 |
| Figure A-5-3 Right Turn Only Lane | A-81 |
| Figure A-5-4 Shared Use Paths | A-84 |
| Figure A-5-5 Cross Section of Two-Way Shared Use Path..... | A-85 |
| Figure A-5-6 Physical Barrier For Shared-Use Path | A-86 |
| Table A-5-7 Minimum Radii For Paved Shared Use Paths Based on 20° Lean Angle..... | A-88 |
| Table A-5-8 Minimum Stopping Sight Distance (Ft.) Descending Grade | A-90 |
| Table A-5-9 Minimum Stopping Sight Distance (Ft.) Ascending Grade | A-90 |
| Table A-5-10 Minimum Length of Crest Vertical Curve (L) Based on Stopping Sight Distance | A-91 |
| Figure A-5-8 Minimum Clearance For Line of Sight | A-92 |
| Table A-5-11 Minimum Lateral Clearance For Horizontal Curves..... | A-92 |
| Figure A-5-9 Shared Use Path Transition From Roadway Onto Bridge For Design Speeds >45 mph | A-98 |
| Figure A-5-10 Interstate Bicycle Route 1 and 76 | A-100 |
| Figure A-5-11 Separation Between Active Rail Lines and Paths (RWT)..... | A-104 |
| Table A-5-12 Separation Between Active Rail Lines and Paths (RWT) | A-105 |

Figure A-5-12 Perpendicular CG-12, Type A A-109
Figure A-5-13 Parallel CG-12, Type B A-110
Figure A-5-14 Parallel and Perpendicular CG-12, Type C..... A-111
Figure A-5-15 Two CG-12 Type B For Each Direction at Intersection A-116
Figure A-5-17 Single Diagonal Parallel Curb Ramp, CG-12, Type B A-118
Figure A-5-18 Single Diagonal Parallel Curb Ramp, CG-12, Type B A-119
Figure A-5-18 Type B Layout Without Buffer Strip A-120
Figure A-5-19 CG-12, Type B Layout, With Buffer Strip A-121
Figure A-5-20 Sidewalk Transition From Roadway Onto Bridge For Design Speeds >45 Mph A-128

APPENDIX A

SECTION A-1-GEOMETRIC DESIGN STANDARDS

INTRODUCTION

VDOT has formally adopted the 2011 AASHTO *A Policy on Geometric Design of Highways and Streets*, commonly referred to as the AASHTO “Green Book”, as our minimum design standards. Therefore, **all** design criteria must meet AASHTO minimum standards.

Highway improvement plans are based on established AASHTO geometric design standards for various elements of the roadway under design. The tables on the following pages provide the **minimum** geometric standards, which are to be used for development of VDOT projects except those projects which can be developed using the Guidelines for RRR Projects located in Appendix A, Section A-4 of this manual. Note that there are no specific RRR standards for Interstate projects. If the designer has determined that Guidelines for RRR Projects do not apply to the project in question, the Geometric Design Standard tables on pages A-11 to A-20 should be used for project development.

The Geometric Standard Tables were developed using *A Policy on Geometric Design of Highways and Streets* published by the American Association of State Highway and Transportation Officials (AASHTO). These tables present basic practical guidelines compatible with traffic, topography and safety; however, due to the restrictive format, all variables could not be included. The designer is urged to refer to the above named publication and other related chapters in the *Road Design Manual* for further discussion of design considerations before selecting the proper design speed criteria for a given project.

THE APPLICATION OF THE CRITERIA PROVIDED IN THE GEOMETRIC DESIGN STANDARD TABLES MUST BE MADE IN RELATION TO THEIR EFFECT ON THE ROADWAY SYSTEM AND IN CONJUNCTION WITH SOUND ENGINEERING JUDGMENT TO ENSURE AN APPROPRIATE DESIGN. The economic, environmental and social factors involved in highway design shall also be considered. The designer should always attempt to provide for the highest degree of safety and best level of service that is economically feasible. The "minimum" design criteria shown in the tables should only be used when overriding economic or environmental considerations so dictate.

FLEXIBILITY IN DESIGN

The policies and procedures addressed in [IIM-LD-235](#) (Context Sensitive Solutions) are intended to clarify and emphasize VDOT's commitment to project and program development processes that provide flexibility, innovative design and Context Sensitive Solutions (CSS) to transportation challenges.

* Rev. 1/15

These processes have been structured and oriented to include stakeholders and citizens in the design of transportation systems that improve public mobility, while reflecting the community's values, preserving the scenic, aesthetic, historic and environmental resources, and without compromising safety and mobility

This policy emphasizes the importance of recognizing the flexibility within established standards, especially AASHTO's *Policy on Geometric Design of Highways and Streets* (Green Book), AASHTO's *A Guide for Achieving Flexibility in Highway Design and AASHTO's Guidelines for Geometric Design of Low-Volume Local Roads (ADT ≤ 400)*. While practicable and innovative approaches to using the flexibility inherent in existing standards is encouraged by this policy, individual project development decisions on specific applications of flexibility ultimately rest with the responsible person working with the project manager and the project team. These decisions are made after carefully processing input from all project stakeholders as well as the project team, and evaluating this input with respect to project goals as well as safety and mobility concerns.

For applicable projects, the following note shall be placed on the title sheet under the Functional Classification and Traffic Data Block: NOTE: THESE PLANS WERE DESIGNED IN ACCORDANCE WITH THE AASHTO GUIDELINES FOR GEOMETRIC DESIGN OF VERY LOW-VOLUME LOCAL ROADS (ADT ≤ 400).

SECONDARY PROJECT IMPROVEMENTS

The Special Session II of the 2008 General Assembly passed HB 6016, which amended and reenacted [§33.2-326](#) of the Code of Virginia relating to improvements to the state secondary highway system components. The intent of this Bill is to ensure that the Department provides flexibility in the use of design criteria for improvements to any secondary highway system component(s) by not requiring the Department to comply with all design and engineering standards that would be applicable if the project involved new construction.

The Department currently utilizes the following flexible design Guidelines:

- **RRR Design Guidelines**, which involves the use of minimal improvements to extend the service life and safety for the existing roadway at a fraction of the cost. On Secondary projects that have a 15 year traffic projection of 750 vpd or less, the RRR guidelines are the design concept of choice.
- **Rural Rustic Road Design Guidelines**, which are used on the secondary highway system that have 1500 vpd or less to pave unpaved secondary roads with no or little geometric improvements.

In addition to the above mentioned practices that follow their own set of guidelines, the Department also encourages roadway designers to identify context sensitive solutions to project issues. It is the responsibility of the roadway design Engineer working with the project manager to identify areas where flexibility can be introduced into the design process without compromising safety and mobility.

* Rev. 10/14

The Department has a process for documenting design solutions that do not meet current VDOT and AASHTO design geometric standards in the form of design waivers and design exceptions that shall be submitted in accordance with [LD-IIM-227](#). Any design exception not granted may be appealed to the Chief Engineer.

ROADWAY WIDTH

Roadway width as referenced in this section is the portion of the highway, including graded shoulders, for vehicular use.

DESIGN SPEED (V)

Design speed is defined as a speed determined for design and correlation of the physical features of a highway that influence vehicle operation - the maximum safe speed maintainable over a specified section of highway when conditions permit design features to govern.

Except for local streets where speed controls are frequently included intentionally, every effort should be made to use as high a Design Speed as practical to attain a desired degree of safety, mobility, and efficiency within the constraints of environmental quality, economics, aesthetics, and social or political impacts (See 2011 AASHTO Green Book, Chapter 2).*

The geometric tables indicate a design speed range, or a portion of a range, for each functional classification. The design speed range for each roadway classification is available in the AASHTO Green Book. The selection of the proper design speed to be used on a particular project is of primary importance in project development. The design speed selected should:

- be logical with respect to topography, anticipated operating speed, adjacent land use, and functional classification of the highway.
- be as high as practicable to attain a desired degree of safety, mobility and efficiency while under the constraints of environmental quality, economics, aesthetics and social or political impacts.
- be consistent with the speed a driver is likely to expect. Drivers do not adjust their speeds to the importance of the highway, but to their perception of the physical limitations and traffic.

Although the design speeds for rural highways are coupled with a terrain classification, terrain is only one of the several factors involved in determining the appropriate design speed of a highway.

* Rev. 7/14

Although the selected design speed establishes the maximum degree of curvature and minimum sight distance necessary for safe operation, there should be no restriction on the use of flatter horizontal curves or greater sight distances where such improvements can be provided as a part of economic design. However, if a succession of flatter curves or tangent sections would encourage drivers to operate at higher speeds, that section of highway should be designed for a higher speed and all geometric features, particularly that of sight distance on crest vertical curves and intersection sight distance should be related to it.

The minimum Design Speed shall be based on the following criteria: *

1) For roadways with a Posted Speed:

a) For high-speed designs (50 mph and greater) Design Speed shall be a minimum of 5 mph greater than the Posted Speed.

- Example - Design Speed 60 mph – Posted Speed 55 mph

b) For low-speed designs (45 mph and less) Design Speed shall be equal to or greater than Posted Speed.

- Example - Design Speed 40 mph – Posted Speed 40 mph

2) For unposted roadways: Design Speed shall be equal to Statutory Speed or 85% percentile speed (based on speed analysis, rounded up to nearest 5 mph increment).

3) Roadways with ADT < 400, see the VDOT Road Design Manual, Appendix B(1), Tables 1 through 3 and AASHTO's "Guidelines for Geometric Design of Very Low-Volume Local Roads (ADT ≤ 400)".

Whenever VDOT criteria (provided above in cases 1-3) are not met, a design waiver is required to document the design speed.

A Design Exception is required if AASHTO minimum design speeds for individual geometric elements are not met.

Additional information is available in NCHRP Report 504 "Design Speed, Operating Speed and Posted Speed Practices", at:

http://onlinepubs.trb.org/onlinepubs/nchrp/nchrp_rpt_504.pdf .

For the determination of the roadway posted speed limits, the plans are to indicate the Design Speed (V) of each horizontal and vertical (crest and sag) curve along with the horizontal and vertical curve data.

* Added 7/14

The Design Speeds (V) are to be determined as follows:*

- Crest Vertical Curves

- See “Sight Distance on Crest Vertical Curves” (VDOT’s [Road & Bridge Standards](#), Section 600) to determine sight distance parameters.
- See 2011 AASHTO Green Book “Crest Vertical Curve” criteria, pages 3-151 through 3-157 to determine the Design Controls.

- Sag Vertical Curves

- See 2011 AASHTO Green Book “Sag Vertical Curve” criteria, pages 3-157 through 3-161 to determine the Design Controls.

Horizontal Curves

- The appropriate Transition Curve Standard (TC-5.01R, TC-5.01U, or TC-5.04ULS, TC-5.11R, TC-5.11U, or TC-5.11ULS) from VDOT’S [Road and Bridge Standards](#), Section 800, provides the Design Speed (V) for horizontal curves (based on the radius of curvature (R) and the superelevation rate (E) provided by GeoPak.

SHOWING DESIGN SPEED (V) FOR HORIZONTAL CURVES ON PLANS

The Design Speed shown on the plans for each horizontal curve is not necessarily the Minimum Design Speed shown on the Title Sheet.

GEOPAK supplies the superelevation dependent upon the input (urban/rural, radius, etc.) for each curve but does not provide the design velocity.

Designers shall determine the Design Speed (V) for each curve. This data is to be shown on the plans in the horizontal curve data for each curve.

Example:

Title Sheet:

Urban Principal Arterial (TC-5.11U - 2011 AASHTO Green Book)
45 mph Minimum Design Speed

Horizontal Curve on plans:

Radius = 1533'
Superelevation = 3.3% (provided by GEOPAK)
V = ?

1. To verify the velocity of the horizontal curve compare project radius and superelevation with Design Factors Charts in Section 800 of the Road and Bridge Standards.

* Added 7/14

2. Start with Page 803.29 TC-5.11U for given Design Speed shown above (45 mph).^{*}
 - ⇒ Chart shows that a curve with 3.3% superelevation and radius of 1446' will support a velocity of 45 mph. The radius on the plans is greater than 1446' (1533').
3. Go to Section 803.30 (50 mph Design Speed).
 - ⇒ Chart shows that a curve with 3.3% superelevation and radius of 1857' will support a velocity of 50 mph, but the radius on the plans is less than 1857' (1533').
4. Therefore, the project radius and superelevation will not support a 50 mph design velocity. The more conservative $V = 45$ mph shall be shown on the plans as the velocity of the curve.

A Design Exception is required whenever the curve radius and superelevation do not support the minimum design speed. See [IIM-LD-227](#) for information on Design Exceptions.

ADDITIONAL RESOURCES

Transportation Research Board, *NCHRP Report 504*, Design Speed, Operating Speed, and Posted Speed Practices, available at:
http://trb.org/publications/nchrp/nchrp_rpt_504.pdf

2004 AASHTO Green Book, "Speed", Chapter 2.

NS 23 CFR 625 available at:
<http://www.fhwa.dot.gov/legregs/directives/fapg/0625sup.htm>

The Federal Aide Policy Guide (FAPG)

"Compatibility of Design Speed, Operating Speed and Posted Speed" (1995 - By FHWA and TXDOT)

ITE's *"Speed: Understanding Design, Operating and Posted Speed"* (1997 - By Ray Krammes (FHWA) and Kay Fitzpatrick (TTI))

[Manual on Uniform Traffic Control Devices](#) (MUTCD, 2009 Edition)

- Note that the statutory speed limit is 55 mph for cars and 45 mph for trucks with the following exceptions: 25 mph in residence and business districts; 35 mph in cities and towns; 35 mph on Rural Rustic Roadways; 35 mph on non-surface treated highways. See the Code of Virginia (Speed Limits).

^{*} Added 7/14

SHOWING DESIGN SPEED ON TITLE SHEET*

See the current version of *Instructional and Informational Memorandum IIM-LD-204* for the method of showing design speed data on the plans.

An asterisk is to be shown adjacent to the Design Speed (Example - * 60 MPH) on the title sheet and the following note shown:

* See Plan and Profile Sheets for the horizontal and vertical curve design speeds.

OPERATING SPEED

Operating Speed is the speed at which drivers are observed operating their vehicles during free-flow conditions. The 85th percentile of the distribution of observed speeds is the most frequently used measure of the operating speed associated with a particular location or geometric feature of a highway, or highway segment.

POSTED SPEED

The Posted Speed for existing, new or reconstructed roadways should be determined by factors outlined in the *MUTCD*, Section 2B.13. The MUTCD requires that an engineering study be conducted in accordance with established engineering practice. VDOT has a standard study template for developing speed limit recommendations which incorporates the MUTCD, Section 2B.13 as well as other considerations pertaining to VDOT's decision-making process for speed limit approvals, including enforcement consensus.

After a project is constructed, the Regional Traffic Engineer will re-establish the speed limit based on established traffic engineering policies. An engineering study will be performed as needed in accordance with documented traffic engineering practices.

It is important to note that the Design Speed shown on the project title sheet may not be the same as the Design Speed of the individual geometric elements. Each curve on the project (horizontal and vertical) should show a Design Speed for that particular feature. Although these curves may present isolated instances where the physical roadway dictates the speed of vehicles, they shall not be the sole basis for determining the posted speed limit. It is more appropriate to address these locations by warning signs. It is only where the physical roadway features dictate the speed of the vehicles on extended sections, for a major portion of the roadway that they should be considered as a limiting factor in setting the speed limit. Such limitations in speed due to physical features will become apparent in the speed analysis conducted as part of the engineering study.

For design criteria and instructions on signing roadways with a design speed < 25 mph, see the VDOT Road Design Manual, Appendix B(1), Tables 1 through 3 and AASHTO's "Guidelines for Geometric Design of Very Low-Volume Local Roads (ADT ≤ 400).

* Added 7/14

DESIGN WAIVERS

Design Waivers are required when deviations from VDOT's design criteria occur. When design criteria meet or exceed AASHTO minimal design but fall short of VDOT's minimal design, a Design Waiver shall be required. Design Waivers will be applicable to all projects regardless of functional classification and funding and shall be documented and approved in accordance with the Design Waiver Request Form [LD-448](#). Please refer to [IIM-LD-227](#) for specific guideline on obtaining design waiver. **This Design Waiver Policy is applicable to VDOT owned and maintained roadways only.**

DESIGN EXCEPTIONS

If there are geometric values that are below AASHTO minimum guidelines, the Project Manager/ Design Engineer shall seek to obtain approval of these design exceptions from the State Location and Design Engineer (all projects) and FHWA (if applicable) no later than Public Hearing Stage. Please refer to [IIM-LD-227](#) for specific guideline on obtaining design exceptions.

FUNCTIONAL CLASSIFICATION

The highway system in Virginia has been functionally classified as Principal Arterial, Minor Arterial, Collector and Local Service. The American Association of State Highway and Transportation Officials (AASHTO) utilizes, as presented in the publication: *A Policy on Geometric Design of Highways and Streets*, referred to as the AASHTO "Green^{*} Book", a similar functional classification system. The designations used are: Freeway, Arterial, Collector, and Local Roads and Streets. Relationships between these two classification systems have been generally developed.

Principal and Minor Arterial Highways provide direct service between cities and larger towns and are high speed, high volume facilities. Collector highways serve small towns directly, connecting them and local roads to the arterial system.

* Rev. 7/12

BACKGROUND

- All roadways are classified as to how the facility functions in accordance with Federal guidelines.
- The Geometric Design Standards in Appendix A of VDOT's *Road Design Manual* are divided by Functional Classification (FC).*
- The terms "Urban" and "Rural" used in the FC do not necessarily coincide with the terms as applied to highway systems in Virginia.

Urban - Urbanized areas within set boundaries having a population of 5,000 or more. This may include areas outside of incorporated cities and towns.

Rural - Areas not designated as Urban. Includes incorporated cities and towns with populations less than 5,000.

VIRGINIA HIGHWAY SYSTEMS

Urban - Roadways within the boundaries of incorporated towns and cities with a population of 3,500 or more plus eight other designated urbanized areas (Bridgewater, Chase City, Elkton, Grottoes, Narrows, Pearisburg, Saltville and Woodstock). The urban program is administered by the Local Assistance Division.

Primary - Primary Roadways

Secondary - All secondary roadways except those in Arlington and Henrico Counties. Projects are administered by the Local Assistance Division.

- A project classified as Urban in FC may be part of the Interstate, Arterial, Primary, or Secondary System and will be administered as such. This applies also to projects classified as Rural.
- The Functional Classification block on the title sheet is to show the Geometric Design Standard used.

If more than one standard is used in the design, it will be necessary to set up two Functional Classification blocks since in most cases there would be a change in traffic volumes and scope of work.

* Rev. 7/09

EXAMPLE

- When the Functional Classification for a project would normally warrant either Geometric Design Standard GS-1, GS-2, GS-3, or GS-4 and Geometric Design Standard GS-5, GS-6, GS-7 or GS-8, respectively, is used then it will be necessary to show the standard used in the design on the title sheet under the Functional Classification.
- If the normal Geometric standard would be GS-3 and Geometric Standard GS-7 is used, the title sheet is to show:

RURAL COLLECTOR-ROLLING-DIVIDED (Urban St'd. GS-7 was used)

LANE/SHOULDER/PAVEMENT TRANSITIONS, MERGING TAPERS & SPEED CHANGE LENGTHS

Lane/shoulder/pavement transitions typically occur where new or reconstructed roadways tie-in to existing roadways. This also applies to where roadways tie-in to bridges. Lane/pavement transitions, merging tapers and speed change lengths shall meet the minimum length provided by the following equations:

For ≤ 40 mph

$$L = S^2W \div 60$$

For > 40 mph*

$$L = W \times S$$

L = length of transition

S = Design Speed

W = Width of offset on each side

Source: 2009 MUTCD, Section 6, Table 6C-4

For Permanent Shoulder and Shifting Tapers see 2009 MUTCD, Section 6, Table 6C-3 and 6C-4.

For Passing/ Left Turn lanes on Two-Lane Highway See Appendix "F", Figure 3-4.

NOTE:

A pavement transition length of 1/2L (calculate L by using the applicable formula above) is to be used when establishing project termini for the majority of small bridge replacement and/or major bridge rehabilitation projects when "NO" horizontal or vertical geometric changes are required to tie into the existing approach alignment. For additional information see Volume 5, Part 2, of the Structure and Bridge Manual.

Pavement transition is separate from the length of need for guardrail. Length of need and shoulder prep for guardrail shall be in accordance with the VDOT RDM Appendix A and the Road & Bridge Standards.

* 7/15

GEOMETRIC DESIGN STANDARDS FOR RURAL PRINCIPAL ARTERIAL SYSTEM (GS-1)

| | TERRAIN | DESIGN SPEED (MPH) | MIN. RADIUS | (6) MINIMUM STOPPING SIGHT DISTANCE | MIN. WIDTH OF LANE | (1) MIN. WIDTH OF TOTAL SHOULDERS (GRADED & PAVED) | | (2) PAVED SHOULDER WIDTH | | (3) MINIMUM WIDTH OF DITCH FRONT SLOPE | (4) SLOPE | NEW AND RECONSTRUCTED MINIMUM BRIDGE WIDTHS AND VERTICAL CLEARANCES |
|-------------|---------|--------------------|-------------|-------------------------------------|--------------------|--|------------|--------------------------|-----|--|-----------|---|
| | | | | | | FILL W/GR | CUT & FILL | LT. | RT. | | | |
| FREEWAYS | LEVEL | 75 | 2215' | 820' | 12' | 17' | 14' | 4' | 12' | 12' | CS-4B | See Footnote (5) |
| | | 70 | 1821' | 730' | | | | | | | | |
| | ROLLING | 60 | 1204' | 570' | | | | | | | | |
| MOUNTAINOUS | 50 | 760' | 425' | 12' | 13' | 10' | 4' | 8' | 10' | CS-4/ CS-4B CS-4/ CS-4E CS-3/ CS-3B | | |
| LEVEL | 70 | 1821' | 730' | | | | | | | | | |
| | 60 | 1204' | 570' | | | | | | | | | |
| ROLLING | 60 | 1204' | 570' | | | | | | | | | |
| | 50 | 760' | 425' | | | | | | | | | |
| MOUNTAINOUS | 50 | 760' | 425' | | | | | | | | | |
| | 45 | 589' | 360' | | | | | | | | | |
| | | 40 | 446' | 305' | | | | | | | | |

GENERAL NOTES

Freeways - A design speed of 75 mph should be used for Rural Freeways. Where terrain is mountainous a design speed of 60 mph or 50 mph, which is consistent with driver expectancy, may be used. All new and major reconstructed Interstate facilities will have a 75 mph design speed unless a lower design speed is approved by the Location and Design Engineer and FHWA.

Other Principal Arterials - A design speed of 40 to 70 mph should be used depending on terrain, driver expectancy and whether the design is constructed on new location or reconstruction of an existing facility. An important safety consideration in the selection of one of the lower design speeds in each range is to have a properly posted speed limit which is enforced during off peak hours.

Incorporated towns or other built-up areas, Urban Standard GS-5 may be used for design. "Built-up" is where there is sufficient development along the roadway that justifies a need to channelize traffic into and out of properties utilizing curb and gutter.

Standard TC-5.11R superelevation based on 8% maximum is to be used for all Rural Principal Arterials.

Clear Zone and Recoverable Area information can be found in Appendix A, Section A-2 of the *Road Design Manual*.

If medians are included, see [Section 2E-3 of Chapter 2E](#) of the *Road Design Manual*.

For additional information on roadway widths and maximum grades relative to terrain and design speed, see AASHTO Green Book, Chapter 7, Section 7.2.2, page 7-4, Tables 7-2 and Section 7.2.3, page 7-5, Table 7-3; for Freeways, see Chapter 8, Section 8.2.7, page 8-4, Table 8-1.

FOOTNOTES

- (1) Graded Shoulders (including the paved portion); Shoulder widths shown are for right shoulders and independently graded median shoulders. No additional width is necessary for guardrail situations.
For 4-lane non-Interstate (2 lanes in each direction) with independently graded median shoulders, an 8' graded median shoulder will be provided. For 6 or more lanes, the graded median shoulder shall be the same as right graded shoulder. For Freeways with truck < 250 DDHV, the graded shoulder width shall be a minimum of 15' for fills and 12' for cuts.
- (2) Paved Shoulders: When the mainline is 6 or more lanes, the left paved shoulder width should be the same as the right paved shoulder. On Freeways, if truck traffic is < 250 DDHV, the right paved shoulder width shall be a minimum of 10'.
- (3) Ditch slopes to be 6:1 - 10' and 12' widths and 4:1 - 6' width. A hydraulic analysis is necessary to determine actual depth requirement.
- (4) Additional or modified slope criteria to apply where shown on typical sections.
- (5) See [Manual of the Structure and Bridge Division – Volume V – Part 2 Design Aids – Chapter 6 Geometrics](#).
- (6) For additional information on sight distance requirements on grades of 3 percent or greater, see Section 3.2.2, page 3-5, Tables 3-2 of the AASHTO Green Book.

FIGURE A - 1 - 1*

GEOMETRIC DESIGN STANDARDS FOR RURAL MINOR ARTERIAL SYSTEM (GS-2)

| TRAFFIC VOLUME | TERRAIN | DESIGN SPEED (MPH) | MIN. RADIUS | (8) MINIMUM STOPPING SIGHT DISTANCE | (2) MIN. WIDTH OF LANE | (3) MIN. WIDTH OF TOTAL SHOULDERS (GRADED & PAVED) | | (4) PAVED SHOULDER WIDTH | | (5) MINIMUM WIDTH OF DITCH FRONT SLOPE | (6) SLOPE | NEW AND RECONSTRUCTED MINIMUM BRIDGE WIDTHS AND VERTICAL CLEARANCES |
|-----------------------|-------------|--------------------|-------------|-------------------------------------|------------------------|--|------------|--------------------------|-----|--|----------------------|---|
| | | | | | | FILL W/GR | CUT & FILL | LT. | RT. | | | |
| (1) ADT OVER 2000 | LEVEL | 70 | 1821' | 730' | 12' | 13' | 10' | 4' | 8' | 10' | CS-4, CS-4A OR CS-4C | See Footnote (7) |
| | | 60 | 1204' | 570' | | | | | | | | |
| | ROLLING | 60 | 1204' | 570' | | | | | | | | |
| | | 50 | 760' | 425' | | | | | | | | |
| | MOUNTAINOUS | 50 | 760' | 425' | | | | | | | | |
| | | 45 | 589' | 360' | | | | | | | | |
| 40 | 446' | 305' | 6' | CS-3/CS-3B | | | | | | | | |
| (1) ADT 1500 TO 2000 | LEVEL | 70 | 1821' | 730' | 12' | 11' | 8' | 4' | 6' | 6' | CS-4, CS-4A OR CS-4C | |
| | | 60 | 1204' | 570' | | | | | | | | |
| | ROLLING | 60 | 1204' | 570' | | | | | | | | |
| | | 50 | 760' | 425' | | | | | | | | |
| | MOUNTAINOUS | 50 | 760' | 425' | | | | | | | | |
| | | 45 | 589' | 360' | | | | | | | | 11' |
| 40 | 446' | 305' | | | | | | | | | | |
| (1) ADT 400 TO 1500 | LEVEL | 70 | 1821' | 730' | 12' | 11' | 8' | 4' | 6' | 6' | CS-4, CS-4A OR CS-4C | |
| | | 60 | 1204' | 570' | | | | | | | | |
| | ROLLING | 60 | 1204' | 570' | | | | | | | | |
| | | 50 | 760' | 425' | | | | | | | | |
| | MOUNTAINOUS | 50 | 760' | 425' | | | | | | | | |
| | | 45 | 589' | 360' | | | | | | | | 11' |
| 40 | 446' | 305' | | | | | | | | | | |
| CURRENT ADT UNDER 400 | LEVEL | 70 | 1821' | 730' | 12' | 9' | 6' | 4' | 4' | 6' | CS-4, CS-4A OR CS-4C | |
| | | 60 | 1204' | 570' | | | | | | | | |
| | ROLLING | 60 | 1204' | 570' | | | | | | | | |
| | | 50 | 760' | 425' | | | | | | | | |
| | MOUNTAINOUS | 50 | 760' | 425' | | | | | | | | |
| | | 45 | 589' | 360' | | | | | | | | 11' |
| 40 | 446' | 305' | | | | | | | | | | |

GENERAL NOTES

Rural Minor Arterials are designed with design speeds of 50 to 70 MPH, dependent on terrain features and traffic volumes, and occasionally may be as low as 40 MPH in mountainous terrain.

In incorporated towns or other built-up areas, Urban Standard GS-6 may be used for design. "Built-up" is where there is sufficient development along the roadway that justifies a need to channelize traffic into and out of properties utilizing curb and gutter.

Standard TC-5.11R superelevation based on 8% maximum is to be used for Rural Minor Arterials.

If medians are included, see Section 2E-3 of Chapter 2E of the *Road Design Manual*.

Clear Zone and Recoverable Area information can be found in Appendix A, Section A-2 of the *Road Design Manual*.

For Passing Sight Distance Criteria, see AASHTO Green Book, Section 3.2.4, page 3-8.

For maximum grades relative to terrain and design speed, see AASHTO Green Book, Chapter 7, Section 7.3.2, page 7-29, Table 7-2.

- (2) Lane width to be 12' at all interchange locations. For projects not on the National Highway System, width of traveled way may remain at 22' on reconstructed highways where alignment and safety records are satisfactory.
- (3) When the mainline is 4 lanes (2 lanes in each direction) and a graded median is used, the width of the graded median shoulder is to be 8'.
- (4) When the mainline is 4 lanes (2 lanes in each direction) a minimum 8' wide paved shoulder shall be provided on the right of traffic and a minimum 4' wide paved shoulder on the median side. Where the mainline is 6 or more lanes, both right and median paved shoulders shall be 8' in width. For additional guidance on shoulder widths/reductions, see AASHTO Green Book, Chapter 7, Section 7.2.11, page 7-13.
- (5) Ditch slopes to be 6:1 - 10' width, 4:1 - 6' width. A hydraulic analysis is necessary to determine actual depth requirement.
- (6) Additional or modified slope criteria to be applied where shown on typical sections.
- (7) See *Manual of the Structure and Bridge Division - Volume V - Part 2 Design Aids - Chapter 6 Geometrics*.
- (8) For additional information on sight distance requirements on grades of 3 percent or greater, see AASHTO Green Book, Chapter 3, Section 3.2.2, page 3-5, Table 3-2.

FOOTNOTES

- (1) Use Design Year ADT for new construction and reconstruction projects (not applicable to R.R.R. projects or roads with ADT < 400) in accordance with *Road Design Manual*, Chapter 2A, "REQUEST FOR TRAFFIC DATA" and Form LD-104.

FIGURE A-1-2*

* Rev. 7/15

GEOMETRIC DESIGN STANDARDS FOR RURAL COLLECTOR ROAD SYSTEM (GS-3)

| TRAFFIC VOLUME | TERRAIN | DESIGN SPEED (MPH) | MIN. RADIUS | (8) MINIMUM STOPPING SIGHT DISTANCE | (2) MIN. WIDTH OF LANE | (3) (4) MINIMUM WIDTH OF GRADED SHOULDERS | | (5) MINIMUM WIDTH OF DITCH FRONT SLOPE | (6) SLOPE | NEW AND RECONSTRUCTED MINIMUM BRIDGE WIDTHS AND VERTICAL CLEARANCES |
|-----------------------|---------------------|--------------------|-------------|-------------------------------------|------------------------|---|-------------|--|----------------------|---|
| | | | | | | FILL W/GR | CUT & FILL | | | |
| (1) ADT OVER 2000 | LEVEL | 60 | 1204' | 570' | 12' | 11' | 8' | 10' | CS-4, CS-4A OR CS-4C | See Footnote (7) |
| | ROLLING | 50 | 760' | 425' | | | | 6' | | |
| | MOUNTAINOUS | 45 | 589' | 360' | | | | | 4' | |
| | | 40 | 446' | 305' | | | | | | |
| (1) ADT 1500 TO 2000 | LEVEL | 50 | 760' | 425' | 11' | 9' | 6' | 6' | CS-4, CS-4A OR CS-4C | |
| | ROLLING | 45 | 589' | 360' | | | | | | |
| | | 40 | 446' | 305' | | | | | | |
| | MOUNTAINOUS | 35 | 316' | 250' | | | | 4' | CS-3/ CS-3B | |
| | | 30 | 215' | 200' | | | | | | |
| | (1) ADT 400 TO 1500 | LEVEL | 50 | 760' | | | | 425' | 11' | |
| ROLLING | | 45 | 589' | 360' | | | | | | |
| | | 40 | 446' | 305' | | | | | | |
| MOUNTAINOUS | | 35 | 316' | 250' | 10' | 4' | CS-3/ CS-3B | | | |
| | | 30 | 215' | 200' | | | | | | |
| CURRENT ADT UNDER 400 | | LEVEL | 45 | 589' | 360' | 10' | 7' | 2' | | 6' |
| | 40 | | 446' | 305' | | | | | | |
| | ROLLING | 35 | 316' | 250' | 4' | | | | | |
| | | 30 | 215' | 200' | | | | | | |
| | MOUNTAINOUS | 25 | 135' | 155' | | | | | | |
| | | 20 | 77' | 125' | | | | | | |

GENERAL NOTES

Geometric design features should be consistent with a design speed appropriate for the conditions.

Low design speeds (45 MPH and below) are generally applicable to highways with curvilinear alignment in rolling or mountainous terrain and where environmental conditions dictate.

High speed design (50 MPH and above) are generally applicable to highways in level terrain or where other environmental conditions are favorable.

Intermediate design speeds would be appropriate where terrain and other environmental conditions are a combination of those described for low and high design speed.

The designer should strive for higher values than the minimum where conditions of safety dictate and costs can be supported.

In incorporated towns or other built-up areas, Urban Standard GS-7 may be used. "Built-up" is where there is sufficient development along the roadway that justifies a need to channelize traffic into and out of properties utilizing curb and gutter.

Standard TC-5.11R superelevation based on 8% maximum is to be used for Rural Collectors.

Clear zone and Recoverable Area information can be found in Appendix A, Section A-2 of the *Road Design Manual*.

For Passing Sight Distance Criteria see AASHTO Green Book, Chapter 3, Section 3.2.4, page 3-8.

For maximum grades relative to terrain and design speed, see AASHTO Green Book, Chapter 6, Section 6.2.1, page 6.2, Table 6-2.

FOOTNOTES

- (1) Use Design Year ADT for new construction and reconstruction projects (not applicable to R.R.R. projects or roads with ADT < 400) in accordance with *Road Design Manual*, Chapter 2A, "REQUEST FOR TRAFFIC DATA" and Form LD-104.
- (2) Lane width to be 12' at all interchange locations.
- (3) Provide 4' wide paved shoulders when design year ADT exceeds 2000 VPD, with 5% or more truck and bus usage. All shoulders not being paved will have the mainline pavement structure extended 1' on the same slope into the shoulder to eliminate raveling at the pavement edge. For additional guidance on shoulder widths, see AASHTO Green Book, Chapter 6, Section 6.2.2, page 6-5.
- (4) When the mainline is four lanes with ADT >2000, a minimum paved shoulder width of 6' right of traffic and 3' left of traffic will be provided.
- (5) Ditch slopes to be 6:1 - 10' width, 4:1 - 6' width, 3:1 - 4' width. A hydraulic analysis is necessary to determine actual depth requirement.
- (6) Additional or modified slope criteria to be applied where shown on typical sections.
- (7) See *Manual of the Structure and Bridge Division – Volume V – Part 2 Design Aids – Chapter 6 Geometrics*.
- (8) For additional information on sight distance requirements on grades of 3 percent or greater, see AASHTO Green Book, Chapter 3, Section 3.2.2, page 3-3, Table 3-2.
- (9) Shoulder width may be reduced to 4' (7' with guardrail) where appropriate as long as a minimum roadway width of 30' is maintained. See AASHTO Green Book, Chapter 6, Section 6.2.2, page 6-6, Table 6-5.

FIGURE A - 1 - 3*

GEOMETRIC DESIGN STANDARDS FOR RURAL LOCAL ROAD SYSTEM (GS-4)

| TRAFFIC VOLUME | TERRAIN | DESIGN SPEED (MPH) | MIN. RADIUS | (9) MINIMUM STOPPING SIGHT DISTANCE | (2) MINIMUM WIDTH OF SURFACING OR PAVEMENT | (3) (4) (5) MINIMUM WIDTH OF GRADED SHOULDERS | | (6) MINIMUM WIDTH OF DITCH FRONT SLOPE | (7) SLOPE | NEW AND RECONSTRUCTED MINIMUM BRIDGE WIDTHS AND VERTICAL CLEARANCES |
|-----------------------|-------------|--------------------|-------------|-------------------------------------|--|---|------------|--|---------------|---|
| | | | | | | FILL W/GR | CUT & FILL | | | |
| (1) ADT OVER 2000 | LEVEL | 50 | 760' | 425' | 24' | 11' (10) | 8' | 6' | CS-4, 4A / 4C | See Footnote (8) |
| | ROLLING | 45 | 589' | 360' | | | | | CS-3, 3A / 3B | |
| | | 40 | 446' | 305' | | | | | | |
| | MOUNTAINOUS | 35 | 316' | 250' | | | | | 4' | |
| 30 | | 215' | 200' | | | | | | | |
| (1) ADT 1500 TO 2000 | LEVEL | 50 | 760' | 425' | 22' | 9' (10) | 6' | 6' | CS-4, 4A / 4C | |
| | ROLLING | 45 | 589' | 360' | | | | | CS-3, 3A / 3B | |
| | | 40 | 446' | 305' | | | | | | |
| | MOUNTAINOUS | 35 | 316' | 250' | | | | | 4' | |
| 30 | | 215' | 200' | | | | | | | |
| (1) ADT 400 TO 1500 | LEVEL | 50 | 760' | 425' | 22' | 8' (10) | 5' | 6' | CS-1 | |
| | ROLLING | 45 | 589' | 360' | | | | | | |
| | | MOUNTAINOUS | 40 | 446' | 305' | | | | | 20' |
| | 35 | | 316' | 250' | | | | | | |
| 30 | 215' | 200' | | | | | | | | |
| CURRENT ADT UNDER 400 | LEVEL | 45 | 589' | 360' | 18' | 7' (10) | 2' | 4' | CS-1 | |
| | | 40 | 446' | 305' | | | | | | |
| | ROLLING | 35 | 316' | 250' | | | | | | |
| | | 30 | 215' | 200' | | | | | | |
| | MOUNTAINOUS | 25 | 135' | 155' | | | | | | |
| | | 20 | 77' | 125' | | | | | | |

GENERAL NOTES

FOOTNOTES

Low design speeds are generally applicable to roads with winding alignment in rolling or mountainous terrain where environmental conditions dictate.

High design speeds are generally applicable to roads in level terrain or where other environmental conditions are favorable.

Intermediate design speeds would be appropriate where terrain and other environmental conditions are a combination of those described for low and high speed.

For minimum design speeds for 250 ADT and under, see AASHTO Green Book, Chapter 5, Section 5.2.1, page 5-2, Table 5-1.

Standard TC-5.11R superelevation based on 8% maximum is to be used.

In incorporated towns or other built-up areas, Urban Standard GS-8 may be used. "Built-up" is where there is sufficient development along the roadway that justifies a need to channelize traffic into and out of properties utilizing curb and gutter.

For Passing Sight Distance Criteria See AASHTO Green Book, Chapter 3, Section 3.2.4, page 3-8.

For maximum grades relative to terrain and design speed, see AASHTO Green Book, Chapter 5, Section 5.2.1, page 5-3, Table 5-2.

For Recreational Access Road design standards, see AASHTO Green Book, Chapter 5, Section 5.4.2, page 5-24.

- (1) Use Design Year ADT for new construction and reconstruction projects in accordance with *Road Design Manual*, Chapter 2A, "REQUEST FOR TRAFFIC DATA" and Form LD-104. For RRR projects or roads with ADT < 400, See *Road Design Manual*, Appendix A, "GUIDELINES FOR RRR PROCTS."
- (2) Lane width to be 12' at all interchange locations.
- (3) In mountainous terrain or sections with heavy earthwork, the graded width of shoulder in cuts may be decreased by 2', but in no case shall the shoulder width be less than 2'.
- (4) Minimum shoulder slope shall be 8% on low side and same slope as pavement on high side (See St'd. GS-12).
- (5) Provide 4' wide paved shoulders when design year ADT exceeds 2000 VPD, with 5% or more truck and bus usage. All shoulders not being paved will have the mainline pavement structure extended 1' on the same slope into the shoulder to eliminate raveling at the pavement edge. For additional guidance on shoulder widths, see AASHTO Green Book, Chapter 5, Section 5.2.2, page 5-5.
- (6) Ditch slopes to be 4:1 - 6' width, 3:1 - 4' width. A hydraulic analysis is necessary to determine actual depth requirement.
- (7) Additional or modified slope criteria to be applied where shown on typical sections.
- (8) See *Manual of the Structure and Bridge Division - Volume V - Part 2 Design Aids - Chapter 6 Geometrics*.
- (9) For additional information on sight distance requirements on grades of 3 percent or greater, see AASHTO Green Book, Chapter 3, Section 3.2.2, page 3-3, Table 3-2.
- (10) See *Road and Bridge Standards, Section 500*, GR-INS for Guardrail Installation.

FIGURE A - 1 - 4*

GEOMETRIC DESIGN STANDARDS FOR URBAN PRINCIPAL ARTERIAL SYSTEM (GS-5)

| | DESIGN SPEED (MPH) | MINIMUM RADIUS | | (13) MINIMUM STOPPING SIGHT DISTANCE | MIN. WIDTH OF LANE | (1) MINIMUM WIDTH OF TOTAL SHOULDERS | | | (2) PAVED SHOULDER WIDTH | | (3) MINIMUM WIDTH OF DITCH FRONT SLOPE | (4) SLOPE | NEW AND RECONSTRUCTED MINIMUM BRIDGE WIDTHS AND VERTICAL CLEARANCES |
|---|--------------------|----------------|------|--------------------------------------|------------------------|--------------------------------------|--------------------|----------------------------|--------------------------|------|--|------------|---|
| | | U | ULS | | | FILL W/GR | FILL | CUT | LT. | RT. | | | |
| FREEWAYS | 70 | # | - | 730' | 12' | 17' | 14' | 14' | 4' | 12' | 12' | CS-4 OR 4B | See Footnote (7) |
| | 60 | # | - | 570' | | | | | | | | | |
| | 50 | # | - | 425' | | | | | | | | | |
| OTHER PRINCIPAL ARTERIAL WITH SHOULDER DESIGN | 60 | # | - | 570' | (12) | 13' | 10' | 10' | 4' | 8' | 10' | CS-4 OR 4E | |
| | 50 | 929' | - | 425' | 12' | | | | | | | | |
| | 45 | 713' | 795' | 360' | (5) (6) (12) 11' | | | | | | 6' | CS-3 OR 3B | |
| | 40 | 536' | 593' | 305' | | | | | | | | | |
| | 35 | 373' | 408' | 250' | | | | | | | | | |
| | 30 | 251' | 273' | 200' | | | | | | | | | |
| | DESIGN SPEED (MPH) | MINIMUM RADIUS | | (13) MINIMUM STOPPING SIGHT DISTANCE | MIN. WIDTH OF LANE | (8) STANDARD CURB & GUTTER | BUFFER STRIP WIDTH | (9) MINIMUM SIDEWALK WIDTH | (10) SLOPE | | | | |
| | | U | ULS | | | | | | | | | | |
| OTHER PRINCIPAL ARTERIAL WITH CURB & GUTTER | 60 | # | - | 570' | (12) | CG-7 | (11) | 5' | 2:1 | | | | |
| | 50 | 929' | - | 425' | 12' | | | | | | | | |
| | 45 | 713' | 795' | 360' | (5) (6) (12) 11' | | | | | CG-6 | | | |
| | 40 | 536' | 593' | 305' | | | | | | | | | |
| | 35 | 373' | 408' | 250' | | | | | | | | | |
| | 30 | 251' | 273' | 200' | | | | | | | | | |

GENERAL NOTES *

Freeways - Urban Freeways should accommodate desired safe operating speeds during non-peak hours, but should not be so high as to exceed the limits of prudent construction, right of way and socioeconomic costs due to the large proportion of vehicles which are accommodated during periods of peak flow when lower speeds are necessary. The design speeds for Freeways should never be less than 50 mph.

On many Urban Freeways, particularly in suburban areas, a design speed of 60 mph or higher can be provided with little additional cost above that required for 50 mph design speed. The corridor of the mainline may be relatively straight and the character and location of interchanges may permit high speed design. Under these conditions, a design speed of 70 mph is most desirable because the higher design speeds are closely related to the overall quality and safety of the facility.

Other Principal Arterials - Design speeds for Urban Arterials generally range from 40 to 60 mph, and occasionally may be as low as 30 mph. The lower (40 mph and below) speeds apply in the central business district and intermediate areas. The higher speeds are more applicable to the outlying business and developing areas.

Standard TC-5.11R (Rural) superelevation based on 8% maximum is to be used for **ALL** Freeways (50 – 70 mph) and is to be used for Other Principal Arterials with a design speed of 60 mph. # For minimum radius, See GS-1.

Standard TC-5.11U (Urban) superelevation based on 4% maximum is to be used on Other Principal Arterials with a design speed of 50 mph and less.

Standard TC-5.11ULS (Urban Low Speed) 1 superelevation based on 2% maximum is to be used on Other Principal Arterials with a design speed less than or equal to 45 mph.

Clear Zone and Recoverable Area information can be found in Appendix A, Section A-2 of the Road Design Manual.

If medians are included, see Section 2E-3 of Chapter 2E of the Road Design Manual.

For minimum widths for roadway and right of way used within incorporated cities or towns to qualify for maintenance funds see Code of Virginia Section 33.2-319.

For guidelines on Interchange Ramps, see Standard GS-R.

For maximum grades relative to terrain and design speed, see AASHTO Green Book, Chapter 7, Section 7.3.3, page 7-29, Table 7-4, for Freeways, see Chapter 8, Section 8.2.1, page 8-4, Table 8-1.

FOOTNOTES

- (1) Shoulder widths shown are for right shoulders and independently graded median shoulders. An 8' graded median shoulder will be provided when the mainline is 4 lanes (2 lanes in each direction). For 6 or more lanes, the median shoulder provided will be the same as that shown for independent grading. On Freeways, if truck traffic is less than 250 DDHV, the minimum width of graded shoulder shall be 15' for fills and 12' for cuts.
- (2) When the mainline is 6 or more lanes, the left paved shoulder width should be the same as the right paved shoulder. On Freeways, if truck traffic is less than 250 DDHV, the minimum right paved shoulder width shall be 10'.
- (3) Ditch slopes to be 6:1 - 10' and 12' widths and 4:1 - 6' width. A hydraulic analysis is necessary to determine actual depth requirement.
- (4) Additional or modified slope criteria apply where shown on typical sections.
- (5) Minimum lane widths to be 12' at all interchange locations.
- (6) Where heavy truck volume (equal to or greater than 10%) or bus traffic is anticipated, an additional 1 foot width should be considered.
- (7) See Manual of the Structure and Bridge Division – Volume V – Part 2 Design Aids – Chapter 6 Geometrics.
- (8) Or equivalent City or Town design.
- (9) Width of 8' or more may be needed in commercial areas.
- (10) 3:1 and flatter slopes shall be used when the right of way is behind the sidewalk (or sidewalk space) in residential or other areas where slopes will be maintained by the property owner.
- (11) For buffer strip widths see Appendix A, Section A-5 Bicycle & Pedestrian Facility Guidelines.
- (12) Situations having restrictions on trucks may allow the use of lanes 1 foot less in width.
- (13) For additional information on sight distance requirements on grades of 3 percent or greater, see AASHTO Green Book, Section 3.2.2, page 3-3, Table 3-2.
- (14) Intersection sight distance requirements see Append. F, Table 2-7.

FIGURE A - 1 - 5

GEOMETRIC DESIGN STANDARDS FOR URBAN MINOR ARTERIAL STREET SYSTEM (GS-6)

| | DESIGN SPEED (MPH) | MINIMUM RADIUS | | (12) MINIMUM STOPPING SIGHT DISTANCE | (11) MIN. WIDTH OF LANE | (3) (10) STANDARD CURB & GUTTER | BUFFER STRIP WIDTH | | (4) MINIMUM SIDEWALK WIDTH | (5) SLOPE | NEW AND RECONSTRUCTED MINIMUM BRIDGE WIDTHS AND VERTICAL CLEARANCES | |
|-----------------------------------|--------------------|----------------|------|--------------------------------------|-------------------------|--|--------------------|--------------------------|----------------------------|--|---|-----------|
| | | U | ULS | | | | | | | | | |
| STREETS WITH CURB & GUTTER | 60 | 1204' | - | 570' | 12' | CG-7 | (10) | | 5' | 2:1 | See Footnote (6) | |
| | 50 | 929' | - | 425' | | | | | | | | |
| | 45 | 713' | 795' | 360' | (1) (2) 11' | CG-6 | | | | | | |
| | 40 | 536' | 593' | 305' | | | | | | | | |
| | 35 | 373' | 408' | 250' | | | | | | | | |
| | 30 | 251' | 273' | 200' | | | | | | | | |
| | DESIGN SPEED (MPH) | MINIMUM RADIUS | | (12) MINIMUM STOPPING SIGHT DISTANCE | (11) MIN. WIDTH OF LANE | (7) (13) MINIMUM WIDTH GRADED SHOULDER | | (8) PAVED SHOULDER WIDTH | | (9) MINIMUM WIDTH OF DITCH FRONT SLOPE | | (5) SLOPE |
| | | U | ULS | | | FILL W/GR | CUT & FILL | LT. | RT. | | | |
| (13) STREETS WITH SHOULDER DESIGN | 60 | 1204' | - | 570' | 12' | 13' | 10' | 4' | 8' | 10' | | 2:1 |
| | 50 | 929' | - | 425' | | | | | | (1) (2) 11' | | |
| | 45 | 713' | 795' | 360' | | | | | | | | |
| | 40 | 536' | 593' | 305' | | | | | | | | |
| | 35 | 373' | 408' | 250' | | | | | | | | |
| | 30 | 251' | 273' | 200' | | | | | | | | |

GENERAL NOTES*

Design Speeds for Urban Arterials generally range from 40 to 60 mph and occasionally may be as low as 30 mph. The lower (40 mph and below) speeds apply in the central business district and intermediate areas. The higher speeds are more applicable to the outlying business and developing areas.

Standard TC-5.11R (Rural) superelevation based on 8% maximum is to be used for 60 mph design speed.

Standard TC-5.11U (Urban) superelevation based on 4% maximum is to be used for design speeds less than 60 mph.

Standard TC-5.11ULS (Urban Low Speed) superelevation based on 2% maximum may be used for design speeds less than or equal to 45 mph.

Clear Zone and Recoverable Area information can be found in Appendix A, Section A-2 of the *Road Design Manual*.

If medians are included, see [Section 2E-3 of Chapter 2E](#) of the *Road Design Manual*.

For minimum widths for roadway and right of way used within incorporated cities or towns to qualify for maintenance funds see [Code of Virginia Section 33.2-319](#).

For maximum grades relative to terrain and design speed, see AASHTO Green Book, Chapter 7, Section 7.3.3, page 7-29, Table 7-4.

FOOTNOTES

- (1) Lane width to be 12' at all interchanges.
- (2) Where heavy truck volume (equal to or greater than 10%) or bus traffic is anticipated, an additional 1 foot width should be considered.
- (3) Or equivalent City or Town design.
- (4) A width of 8' or more may be needed in commercial areas.
- (5) Slopes 3:1 and flatter shall be used when the right of way is behind the sidewalk (or sidewalk space) in residential or other areas where slopes will be maintained by the property owner.
- (6) See [Manual of the Structure and Bridge Division – Volume V – Part 2 Design Aids – Chapter 6 Geometrics](#).
- (7) If graded median is used, the width of median shoulder is to be 8' (See Standard GS-11 for shoulder design).
- (8) When the mainline is 4 lanes (2 lanes in each direction) a minimum 8' wide paved shoulder will be provided on the right of traffic and a minimum 4' wide paved shoulder on the median side. Where the mainline is 6 or more lanes, both right and median paved shoulders will be 8' in width. For additional guidance on shoulder widths/reductions, see AASHTO Green Book, Chapter 7, Section 7.2.11, page 7-13.
- (9) Ditch slope to be 6:1 - 10' width and 4:1 - 6' width. A hydraulic analysis is necessary to determine actual depth requirement.
- (10) For buffer strip widths see Appendix A, Section A-5 Bicycle & Pedestrian Facility Guidelines.
- (11) Situations having restrictions on trucks may allow the use of lanes 1 foot less in width.
- (12) For additional information on sight distance requirements on grades of 3 percent or greater, see AASHTO Green Book, Chapter 3, Section 3.2.2, page 3-3, Table 3-2.
- (13) For information on reduced shoulder widths, see AASHTO Green Book, Chapter 7, Section 7.2.3, page 7-5, Table 7-3.

FIGURE A - 1 - 6

GEOMETRIC DESIGN STANDARDS FOR URBAN COLLECTOR STREET SYSTEM (GS-7)

| | DESIGN SPEED (MPH) | MINIMUM RADIUS | | (10) MINIMUM STOPPING SIGHT DISTANCE | (13) MINIMUM WIDTH OF LANE | (3) (9) STANDARD CURB & GUTTER | BUFFER STRIP WIDTH | (4) MINIMUM SIDEWALK WIDTH | (5) SLOPE | NEW AND RECONSTRUCTED MINIMUM BRIDGE WIDTHS AND VERTICAL CLEARANCES |
|----------------------------------|--------------------|----------------|------|--------------------------------------|----------------------------|--|--------------------|--|-----------|---|
| | | U | ULS | | | | | | | |
| STREET WITH CURB & GUTTER | 50 | 929' | - | 425' | 12' | CG-7 | (9) | 5' | 2:1 | See Footnote (8) |
| | 45 | 713' | 794' | 360' | (1) (2) (12) 11' | | | | | |
| | 40 | 536' | 593' | 305' | | CG-6 | | | | |
| | 35 | 373' | 408' | 250' | | | | | | |
| | 30 | 251' | 273' | 200' | | | | | | |
| | DESIGN SPEED (MPH) | MINIMUM RADIUS | | (10) MINIMUM STOPPING SIGHT DISTANCE | (13) MINIMUM WIDTH OF LANE | (7) (11) MINIMUM WIDTH OF GRADED SHOULDERS | | (6) MINIMUM WIDTH OF DITCH FRONT SLOPE | (5) SLOPE | |
| | | U | ULS | | | FILL W/GR | CUT & FILL | | | |
| (11) STREET WITH SHOULDER DESIGN | 50 | 929' | - | 425' | 12' | 11' | 8' | 6' | 2:1 | |
| | 45 | 713' | 795' | 360' | (1) (2) (12) 11' | | | | | |
| | 40 | 536' | 593' | 305' | | | | | | |
| | 35 | 373' | 408' | 250' | | | | | | |
| | 30 | 251' | 273' | 200' | | | | 4' | | |

GENERAL NOTES

A minimum design speed of 30 mph or higher should be used for collector streets, depending on available right of way, terrain, adjacent development and other area controls.

In the typical street grid, the closely spaced intersections usually limit vehicular speeds and thus make the effect of design speed of less significance. Nevertheless, the longer sight distances and curve radii commensurate with design speeds higher than the value indicated result in safer highways and should be used to the extent practicable.

Standard TC-5.11U (Urban) superelevation based on 4% maximum.

Standard TC-5.11ULS (Urban-Low Speed) superelevation based on 2% maximum may be used with a design speed of 45 mph or less.

For minimum widths for roadway and right of way used within incorporated cities or towns to qualify for maintenance funds see [Code of Virginia Section 33.2-319](#).

Clear zone and Recoverable Area information can be found in Appendix A, Section A-2 of the [Road Design Manual](#).

For maximum grades relative to terrain and design speed, see AASHTO Green Book, Chapter 6, Section 6.3.1, page 6-12, Table 6-8.

FOOTNOTES

(1) Lane width should be 12' in industrial areas. Where Right of Way is restricted 11' lanes may be used in industrial areas. (See AASHTO Green Book Chapter 6, Section 6.2.2 and 6.3.2, page 6-6, Table 6-6).

- (2) Lane width to be 12' at all interchange locations.
- (3) Or equivalent City or Town Design.
- (4) 8' or more may be needed in commercial areas.
- (5) 3:1 and flatter slopes shall be used when right of way is behind the sidewalk (or sidewalk space) in residential or other areas where the slopes will be maintained by the property owner.
- (6) Ditch slopes to be 4:1 - 6' width and 3:1 - 4' width. A hydraulic analysis is necessary to determine actual depth requirement.
- (7) When Design year ADT exceeds 2000 VPD, with greater than 10% total truck and bus usage: Provide 4' wide paved shoulders when the graded shoulder is 5' wide or greater. All shoulders not being paved will have the mainline pavement structure extended 1', on the same slope, into the shoulder to eliminate raveling at the pavement edge. (See Standard GS-11 for shoulder design).
- (8) See [Manual of the Structure and Bridge Division – Volume V – Part 2 Design Aids – Chapter 6 Geometrics](#).
- (9) For buffer strip widths see Appendix A, Section A-5 Bicycle & Pedestrian Facility Guidelines.
- (10) For additional information on sight distance requirements on grades of 3 percent or greater, see AASHTO, Green Book, Chapter 3, Section 3.2.2, page 3-3, Table 3-2.
- (11) For information on reduced shoulder widths, see AASHTO Green Book, Chapter 6, Section 6.2.2, page 6-6, Table 6-5.
- (12) Where heavy truck volume (equal to or greater than 10%) or bus traffic is anticipated, an additional 1 foot width should be considered.
- (13) Situations having restrictions on trucks may allow the use of lanes 1 foot less in width.

FIGURE A - 1 - 7*

GEOMETRIC DESIGN STANDARDS FOR URBAN LOCAL STREET SYSTEM (GS-8)

| | DESIGN SPEED (MPH) | MINIMUM RADIUS | | (1) MAXIMUM PERCENT OF GRADE | (10) MINIMUM STOPPING SIGHT DISTANCE | (2) MINIMUM WIDTH OF LANE | (3) STANDARD CURB & GUTTER | BUFFER STRIP WIDTH | (5) MINIMUM SIDEWALK WIDTH | (6) SLOPE | NEW AND RECONSTRUCTED MINIMUM BRIDGE WIDTHS AND VERTICAL CLEARANCES |
|----------------------------------|--------------------|----------------|------|------------------------------|--------------------------------------|---------------------------|--|--------------------|--|-----------|---|
| | | U | ULS | | | | | | | | |
| STREET WITH CURB & GUTTER | 30 | 251' | 273' | 15 | 200' | 10' | CG-6 | (4) | 5' | 2:1 | See Footnote (9) |
| | 25 | 155' | 167' | | 155' | | | | | | |
| | 20 | 92' | 92' | | 125' | | | | | | |
| | DESIGN SPEED (MPH) | MINIMUM RADIUS | | (1) MAXIMUM PERCENT OF GRADE | (10) MINIMUM STOPPING SIGHT DISTANCE | (2) MINIMUM WIDTH OF LANE | (7) (11) MINIMUM WIDTH OF GRADED SHOULDERS | | (8) MINIMUM WIDTH OF DITCH FRONT SLOPE | SLOPE | |
| | | U | ULS | | | | FILL W/GR | CUT & FILL | | | |
| (11) STREET WITH SHOULDER DESIGN | 30 | 251' | 273' | 15 | 200' | 10' | 11' | 8' | 4' | 3:1 | |
| | 25 | 155' | 167' | | 155' | | | | | | |
| | 20 | 92' | 92' | | 125' | | | | | | |

GENERAL NOTES

Design Speed is not a major factor for local streets. For consistency in design elements, design speeds ranging from 20 to 30 mph may be used, depending on available right of way, terrain, adjacent development and other area controls.

In the typical street grid, the closely spaced intersections usually limit vehicular speeds, making the effect of a design speed of less significance.

Design speeds exceeding 30 mph in residential areas may require longer sight distances and increased curve radii, which would be contrary to the basic function of a local street.

Standard TC-5.11U (Urban) superelevation based on 4% maximum.

Standard TC-5.11ULS (Urban Low Speed) superelevation based on 2% maximum may be used with a design speed of 45 mph or less.

For minimum widths for roadway and right of way used within incorporated cities or towns to qualify for maintenance funds see [Code of Virginia Section 33.2-319](#).

FOOTNOTES

- (1) Grades in commercial and industrial areas should be less than 8 percent; desirably, less than 5 percent. For maximum grades relative to terrain and design speed, see AASHTO Green Book, Chapter 5, Section 5.2.1, page 5-5, Table 5-4.
- (2) Where feasible, lanes should be 11' wide and in industrial areas should be 12' wide; however, where available or attainable right of way imposes severe limitations, 9' lanes can be used in residential areas and 11' lanes can be used in industrial areas.

- (3) Or equivalent City or Town design.
- (4) For buffer strip widths see Appendix A, Section A-5 Bicycle & Pedestrian Facility Guidelines.
- (5) A width of 8' or more may be needed in commercial areas.
- (6) 3:1 and flatter slopes shall be used when the right of way is behind the sidewalk (or sidewalk space) in residential or other areas where slopes will be maintained by the property owner.
- (7) When Design year ADT exceeds 2000 VPD, with greater than 5% total truck and bus usage: Provide 4' wide paved shoulders when the graded shoulder is 5' wide or greater. All shoulders not being paved will have the mainline pavement structure extended 1', on the same slope, into the shoulder to eliminate raveling at the pavement edge (See Standard GS-12 for shoulder design).
- (8) Ditch slopes to be 3:1 - 4' width. A hydraulic analysis is necessary to determine actual depth requirement.
- (9) See [Manual of the Structure and Bridge Division – Volume V – Part 2 Design Aids – Chapter 6 Geometrics](#).
- (10) For additional information on sight distance requirements on grades of 3 percent or greater, see AASHTO Green Book, Chapter 3, Section 3.2.2, page 3-3, Table 3-2.
- (11) For information on reduced shoulder widths, see AASHTO Green Book, Chapter 5, Section 5.2.2, page 5-6, Table 5-5.

FIGURE A - 1 - 8*

GEOMETRIC DESIGN STANDARDS FOR SERVICE ROADS (GS-9)

| (1) DEAD END SERVICE ROADS UNDER 25 VPD | | | | | | | | |
|---|--------------------|----------------|-------------------------|------------------------------|---------------------------|------------|--|-------|
| PROPERTIES SERVED | DESIGN SPEED (MPH) | MINIMUM RADIUS | STOPPING SIGHT DISTANCE | (2) MINIMUM TRAVEL WAY WIDTH | MINIMUM WIDTH OF SHOULDER | | (3) MINIMUM WIDTH OF DITCH FRONT SLOPE | SLOPE |
| | | | | | FILL W/GR | CUT & FILL | | |
| 1 | 10 | 30' | 50' | 12' | 5' | 2' | 3' | (4) |
| | 15 | 38' | 80' | | | | | |
| OVER 1 | 20 | 77' | 125' | 16' | | | | |
| | 25 | 135' | 155' | | | | | |
| | 30 | 215' | 220' | 18' | | | | |
| | 35 | 316' | 250' | | | | | |
| 40 | 446' | 305' | | | | | | |

GENERAL NOTES

The minimum design speed for service roads should be 20 mph except for one lane service roads serving one property which may have a minimum design speed of 10 mph.

Standard TC-5.11R superelevation is based on 8% maximum.

For Passing Sight Distance Criteria See AASHTO Green Book, Chapter 3, Section 3.2.4, page 3-8.

FOOTNOTES

- (1) For through service roads and dead end service roads with over 25 VPD, use Standards shown for Local Roads and Streets (Also See Standard GS-12).
- (2) Under adverse conditions, intermittent shoulder sections or turnouts for passing may be required (see AASHTO Green Book, Chapter 5, Section 5.4.2, page 5-29).
- (3) Ditch slope to be 3:1. A hydraulic analysis is necessary to determine actual depth requirement.
- (4) Slopes to be same as mainline when service road is parallel to or otherwise visible from the mainline. For other cases, slopes should be in accordance with standards for Local Roads and Streets.

| RELATIONSHIP OF MAXIMUM GRADES TO DESIGN SPEED | | | | |
|--|--------------------|----|----|----|
| TYPE OF TERRAIN | DESIGN SPEED (MPH) | | | |
| | 10 | 20 | 30 | 40 |
| | GRADES (PERCENT) | | | |
| LEVEL | 8 | 8 | 7 | 7 |
| ROLLING | 12 | 11 | 10 | 9 |
| MOUNTAINOUS | 18 | 16 | 14 | 12 |

FIGURE A - 1 - 9*

* Rev. 1/14

GEOMETRIC DESIGN STANDARDS FOR INTERCHANGE RAMPS (GS-R)

| | RAMP DESIGN SPEED (MPH) | MINIMUM RADIUS | (6) MINIMUM STOPPING SIGHT DISTANCE | (1) MINIMUM RAMP PAVEMENT WIDTHS | MINIMUM WIDTH OF SHOULDER | | | | (5) MINIMUM WIDTH OF DITCH FRONT SLOPE | NEW AND RECONSTRUCTED MINIMUM BRIDGE WIDTHS AND VERTICAL CLEARANCES | |
|-------------------|-------------------------|----------------|-------------------------------------|----------------------------------|---------------------------|------------|---------------------|------------------|--|---|---------------------|
| | | | | | LEFT OF TRAFFIC | | RIGHT OF TRAFFIC | | | | |
| | | | | | GRADED WIDTH | | (2) (3) PAVED WIDTH | (7) GRADED WIDTH | | | (2) (3) PAVED WIDTH |
| | | | | | FILL W/GR | CUT & FILL | | | | | |
| INTERCHANGE RAMPS | 60 | 1204' | 570' | 16' | 9' | 6' | 4' | 10' | 8' | 10' | See Footnote (4) |
| | 50 | 760' | 425' | | | | | | | | |
| | 45 | 589' | 360' | | | | | | | | |
| | 40 | 446' | 305' | | | | | | | | |
| | 35 | 316' | 250' | | | | | | | | |
| | 30 | 215' | 200' | 18' | | | | | | | |
| | 25 | 135' | 155' | | | | | | | | |
| 20 | 77' | 125' | | | | | | | | | |
| AUXILIARY LANES | | | | | | | | | | AUXILIARY LANE SHOULDER WIDTHS ARE TO BE THE SAME AS MAINLINE THROUGH LANES | |

GENERAL NOTES

FOOTNOTES

The determination of the proper design speed for any particular ramp should be made using guidelines shown in the AASHTO Green Book, Chapter 10, Section 10.9.6, page 10-89, Table 10-1.

Standard TC-5.11R is to be used. Maximum ramp superelevation is to be 8%.

Clear Zone and Recoverable Area information can be found in Appendix A, Section A-2 of the *Road Design Manual*.

| RELATIONSHIP OF MAXIMUM GRADES TO DESIGN SPEED | | | |
|--|---------|---------|---------|
| DESIGN SPEED (MPH) | | | |
| 15 - 20 | 25 - 30 | 35 - 40 | 45 - 50 |
| GRADES (PERCENT) | | | |
| 6 - 8 | 5 - 7 | 4 - 6 | 3 - 5 |

Where topographic conditions dictate, grades steeper than desirable may be used. One-way descending gradients on ramps should be held to the same general maximums, but in special cases they may be 2 percent greater. However, downgrades with sharp horizontal curvature and significant heavy truck or bus traffic should be limited to 4 percent. See page 10-92 of the AASHTO Green Book.

See the AASHTO Green Book Chapter 10, Section 10.9.6, page 10-87 for further guidance on ramp design.

- Interchange ramp widths shown are for one lane traffic. For two lane or other conditions see Table 3-29 in the AASHTO Green Book.
- Shoulder widths on ramps with a design speed of 40 mph or less may be reduced to 6' right, or 3' left, when justifiable. However, the sum of the right and left shoulder shall not be less than 10'. See AASHTO Green Book, Chapter 10, Section 10.9.6, page 10-102.
- On ramps with a radius of less than 500', consider (depending on degree of curvature, percent of trucks) the extension of the full pavement structure (on the same slope as the pavement) through the inside paved shoulder area to eliminate raveling of the pavement edge.
- See [Manual of the Structure and Bridge Division – Volume V – Part 2 Design Aids – Chapter 6 Geometrics](#).
- Ditch slopes to be 6:1. A hydraulic analysis is necessary to determine actual depth requirement.
- For additional information on sight distance requirements on grades of 3 percent or greater, see the AASHTO Green Book, Chapter 3, Section 3.2.2, page 3-3, Table 3-2.
- Shoulder width to be increased additional 3' when guardrail is required.

FIGURE A - 1 - 10*

* Rev. 1/14

GEOMETRIC DESIGN STANDARDS FOR TEMPORARY DIVERSION (GS-10)

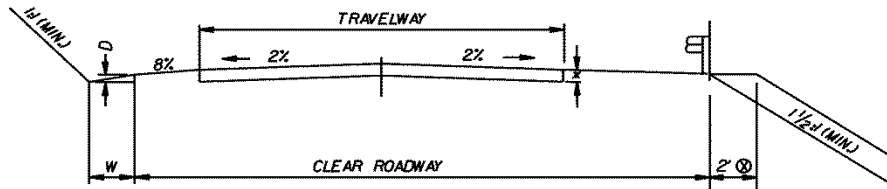

* SEE PLANS FOR BASE DEPTH AND TYPE AND PAVED SURFACE TREATMENT WHERE REQUIRED.

TYPICAL SECTION

⊗ FOR GUARDRAIL:
ADD 2' TO 4' SHOULDERS
ADD 3' TO ALL OTHER SHOULDERS

BRIDGE WIDTH = APPROACH ROADWAY WIDTH (CLEAR ROADWAY).

| WIDTHS FOR TWO WAY TRAFFIC (LESSER WIDTH MAY BE USED FOR ONE-WAY) | | | | | | | | |
|--|----------------|-------------------|---------|-------|-------------------------------------|-----------------|-----------------|----------|
| TYPE | CURRENT ADT | * TRAVELWAY WIDTH | SURFACE | | MIN. ROADWAY SHOULDER TO SHOULDER ⊗ | DITCH WIDTH (W) | DITCH DEPTH (D) | PAY ITEM |
| | | | UNPAVED | PAVED | | | | |
| A | 0-250 | 18' | ✓ | | 22' | 4' | 16' | LF. |
| B | 251-750 | 20' | ✓ | | 24' ABS. 30' DES. | 4' | 16' | LF. |
| C | 751-2000 | 22' | | ✓ | 30' ABS. 34' DES. | 4' | 16' | * * |
| D | 2001-5500 | 24' | | ✓ | 40' | 4' | 16' | * * |
| E | 5501-15,000 | 24' | | ✓ | 40' | 4' | 16' | * * |
| F | 15,000 - ABOVE | 24' | | ✓ | 40' | 6' | 18' | * * |

* CURVES TO BE WIDENED IN ACCORDANCE WITH ST'D.TC-5.II.R.
** PAID FOR BY INDIVIDUAL QUANTITIES.

| GEOMETRICS | | | | | | | |
|-------------------------|------|-------|--------|--------|--------|---------|---------|
| DESIGN SPEED M.P.H. | | 20 | 30 | 40 | 50 | 60 | 70 |
| MIN. RADII | | 77' R | 215' R | 446' R | 760' R | 1204' R | 1821' R |
| MAX. % GRADE | DES. | 8% | 7% | 7% | 6% | 5% | 5% |
| | ABS. | 16% | 14% | 13% | 10% | 6% | 6% |
| STOPPING SIGHT DISTANCE | DES. | 125' | 200' | 325' | 475' | 650' | 850' |
| | MIN. | | | 305' | 425' | 570' | 730' |
| MAXIMUM SUPERELEVATION | | 8% | 8% | 8% | 8% | 8% | 8% |

IF GEOMETRICS AND WIDTHS SHOWN IN THESE CHARTS ARE GREATER THAN THE FINISHED CONTRACT DESIGN, APPROVAL MAY BE GRANTED BY THE DEPARTMENT FOR LESSER VALUES.

MINIMUM DESIGN CRITERIA FOR TEMPORARY DIVERSION
(MAINTENANCE OF TRAFFIC)

FIGURE A - 1 - 11*

GEOMETRIC DESIGN STANDARDS FOR SHOULDER DESIGN (GS-11)

GRADED MEDIAN SHOULDERS

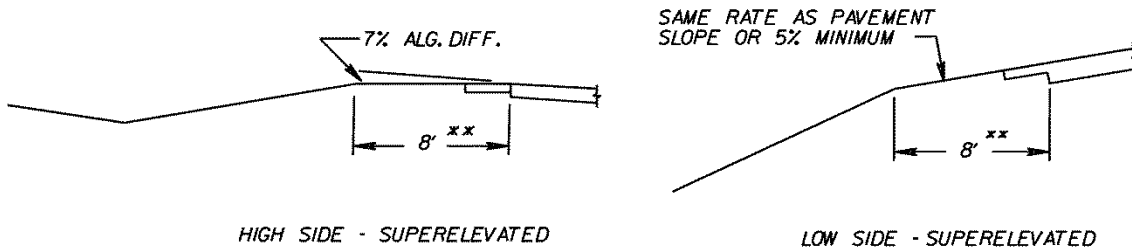

** WHERE MAINLINE IS 6 OR MORE LANES GRADED SHOULDER WIDTH IS TO BE THE SAME AS THAT SHOWN FOR FILL SHOULDER FOR INDEPENDENT GRADING.

OUTSIDE SHOULDERS

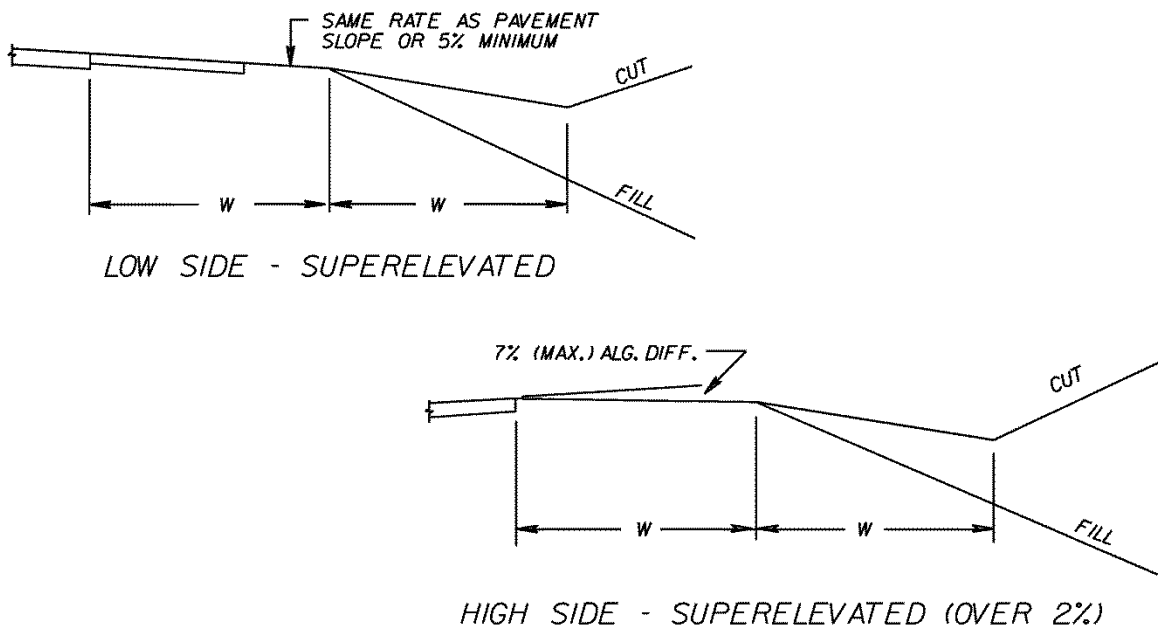

NOTE: FOR WIDTH OF SHOULDERS AND DITCHES (W) SEE GEOMETRIC DESIGN STANDARDS.

STANDARD SHOULDER DESIGN FOR ALL SYSTEMS EXCEPT LOCAL ROADS AND STREETS

FIGURE A - 1 - 12*

* Rev. 7/14

GEOMETRIC DESIGN STANDARDS FOR SHOULDER DESIGN FOR LOCAL ROAD AND STREETS (GS-12)

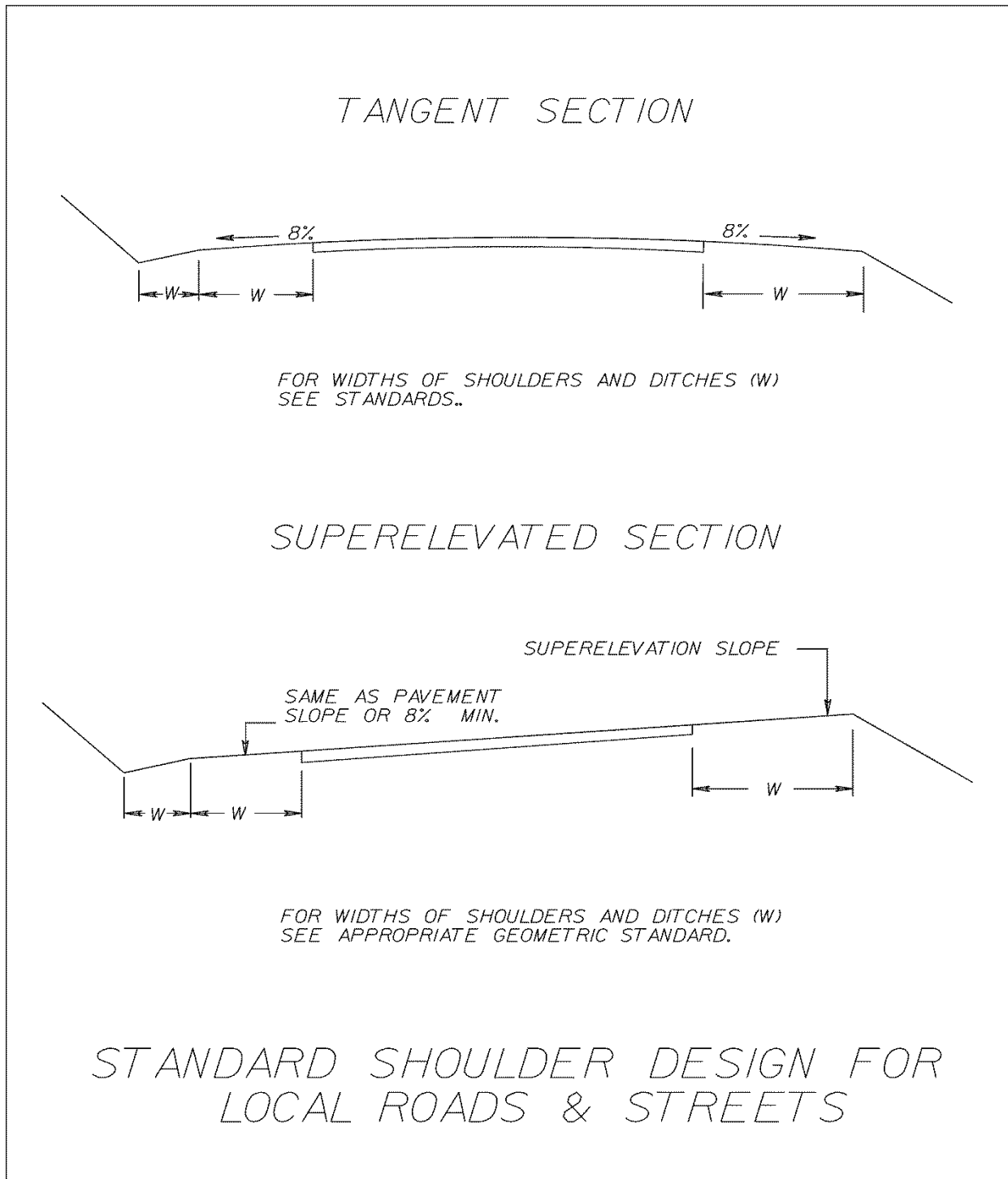

FIGURE A - 1 - 13*

* Added 1/12

GEOMETRIC DESIGN STANDARDS FOR GRADED MEDIAN DESIGN (GS-13)

MEDIAN EDGES OF SHOULDER AT SAME OR APPROXIMATELY SAME ELEVATION

(GRADING TO CENTER OF MEDIAN)

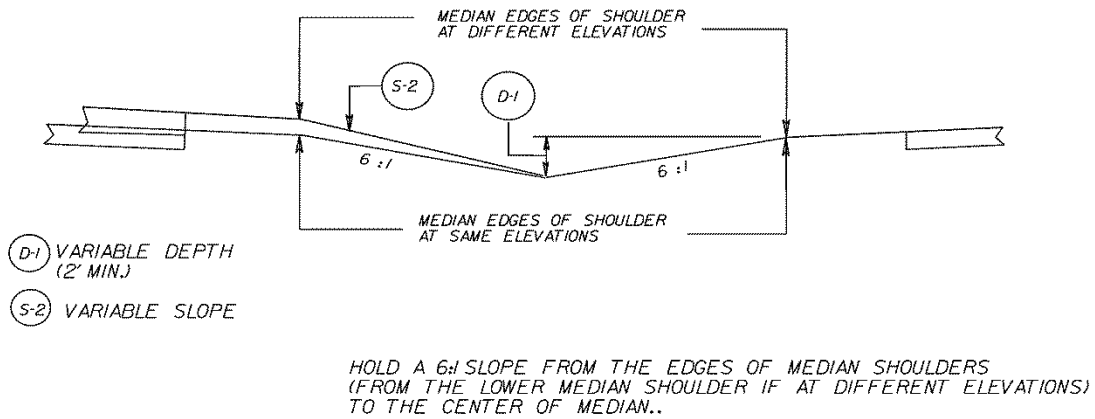

MEDIAN EDGES OF SHOULDER AT DIFFERENT ELEVATIONS

(GRADING FROM HIGH SHOULDER TO DITCH ADJACENT TO LOWER ROADWAY)

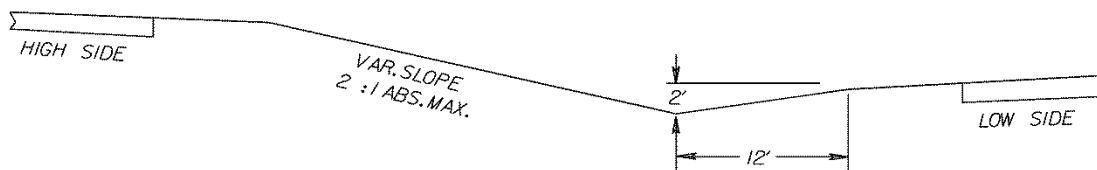

HOLD A 2' DITCH DEPTH, 12' WIDE, ADJACENT TO LOWER SHOULDER.

STANDARD GRADED MEDIAN DESIGNS

FIGURE A - 1 - 14*

* Added 1/12

SECTION A-2-CLEAR ZONE/LATERAL OFFSET GUIDELINES

INTRODUCTION

The term “clear zone” is used to describe the unobstructed, traversable area provided beyond the edge of the **through** traveled way for the recovery of an errant vehicle. The clear zone includes shoulders, bike lanes, parking lanes and auxiliary lanes (except those auxiliary lanes that function like through lanes). Clear zone distances are based upon traffic volume, speed, and embankment slopes.

A recoverable area is to be provided that is clear of all unyielding obstacles such as trees, sign supports, utility poles, light poles, or any other fixed objects that might severely damage an out-of-control vehicle (See 2011 AASHTO *A Policy on Geometric Design of Highways and Streets*, Chapter 5). Determining a practical clear zone often involves a series of compromises between absolute safety, engineering judgment, environmental and economic constraints. Additional information is available in AASHTO’s *Roadside Design Guide*.

ROADWAYS WITH SHOULDERS

In rural environments, where speeds are higher and constraints are fewer, a clear zone appropriate for the traffic volume, design speed, and facility type should be provided in accordance with the AASHTO *Roadside Design Guide*, Chapter 3. These values also are applicable for freeways and other controlled-access facilities in urban areas. For an example, see Figure A-2-1, Case 1.

Whenever adequate right of way is available, urban projects should be designed with shoulders in lieu of curbs (unless city ordinances require otherwise) and clear zone widths should be consistent with the requirements for roadways with shoulders. (See 2011* AASHTO *“A Policy on Geometric Design of Highways and Streets”*, Chapter 7). The justification for providing a curb is to be documented in the project file (e.g. Preliminary Field Inspection Report, recommendation from Right of Way and Utilities Division, etc.).

For Rural Local Roads, Urban Local Streets with paved shoulders and Collectors with design speeds ≤ 45 mph, as much clear zone as practical should be provided, with a minimum of 10’ beyond the traveled way. (See 2011 AASHTO *A Policy on Geometric Design of Highways and Streets*, Chapters 4, 5 and 6). For an example, see Figure A-2-1, Case 2.

On projects such as RRR, intersection improvements, etc. recoverable areas are not always practical due to the intent of the project to provide minimal improvements and extend the service life of the existing roadway for a fraction of the costs of reconstruction. However, as much clear zone as practical should be provided.

Sources: *TRB Special Report 214, Designing Safer Roads* / 2011 AASHTO *A Policy on Geometric Design of Highways and Streets*, Chapters 4-7 / 2011 AASHTO *Roadside Design Guide*.

* Rev. 7/13

ROADWAYS WITH CURB

For urban arterials and other non-controlled access facilities in an urban environment, right of way is often extremely limited. In many cases, establishing a clear zone using the guidance in the *Roadside Design Guide*, Chapter 3 is not practical. These urban environments are characterized by sidewalks beginning at the face of the curb, enclosed drainage, numerous fixed objects (e.g. signs, utility poles, luminaire supports, fire hydrants, sidewalk furniture), and frequent traffic stops. These environments typically have lower operating speeds and in many instances, on-street parking. In these environments, a lateral offset to vertical obstructions (e.g. signs, utility poles, luminaire supports, fire hydrants), including breakaway devices, is needed to accommodate motorist operating on the highway.

When providing clear zone in accordance with the *Roadside Design Guide* in an urban area is not practical, consideration should be given to establishing as much lateral offset as practical, or incorporating as many clear-zone concepts as practical, such as removing roadside objects or making them crashworthy. Ideally, appurtenances (e.g. benches, trash barrels, bicycle racks) should be located as far away as practical, but at least 4 feet from the face of curb. Breakaway designs shall* be used for poles and appurtenances located less than 6 feet from the face of curb. See Figure A-2-1, Case 4 and Case 5.

Although the clear roadway concept is still the goal, many compromises are likely in urban or restricted environments. A minimum lateral offset of 1.5 feet shall be provided beyond the face of curb, with 3 feet minimum at intersections and driveway openings (10'–15' recommended, See *Roadside Design Guide*, Chapter 10). Note that this minimum lateral offset does not meet clear zone criteria but simply enables normal facility operations by providing clearance for turning trucks, etc. Consideration should be given to providing more than the minimum lateral offset to obstructions by placing fixed objects behind the sidewalk or sidewalk space. See Figure A-2-1, Case 2.*

Note that curb is applicable to roadways with design speeds ≤ 45 mph and should be used on roadways > 45 mph only in special situations. These situations may include, but are not limited to drainage considerations, a need for access control and right of way restrictions.

When a vertical drop-off or other hazard (see Section I-3, Guardrail Warrants) is located within 6' of the face of curb, guardrail should be considered. For instructions on the placement of guardrail adjacent to curb, see Section I-3, Guardrail Installation in Urban Settings. Contact the Location and Design Standards and Special Design Section for details.

Any fixed objects (signs, luminaire supports, large trees, etc.) located within a curbed median should not be located less than 6' from the face of curb. See Figure A-2-1, Case 5.

Source: AASHTO Green Book, Chapter 4, Section 4.7.1, page 4-16 / *Roadside Design Guide*, Chapter 10

* Rev. 1/15

| DESIGN SPEED | DESIGN ADT | FORESLOPES | | | BACKSLOPES | | |
|------------------------|------------------------|--------------------|--------------------|-----|------------|------------|----------------|
| | | 6:1 or Flatter | 5:1 to 4:1 | 3:1 | 3:1 | 5:1 to 4:1 | 6:1 or Flatter |
| 40 mph or less | Under 750 ^c | 7-10 | 7-10 | b | 7-10 | 7-10 | 7-10 |
| | 750-1500 | 10-12 | 12-14 | b | 10-12 | 10-12 | 10-12 |
| | 1500-6000 | 12-14 | 14-16 | b | 12-14 | 12-14 | 12-14 |
| | Over 6000 | 14-16 | 16-18 | b | 14-16 | 14-16 | 14-16 |
| 45-50 mph | Under 750 ^c | 10-12 | 12-14 | b | 8-10 | 8-10 | 10-12 |
| | 750-1500 | 14-16 | 16-20 | b | 10-12 | 12-14 | 14-16 |
| | 1500-6000 | 16-18 | 20-26 | b | 12-14 | 14-16 | 16-18 |
| | Over 6000 | 20-22 | 24-28 | b | 14-16 | 18-20 | 20-22 |
| 55 mph | Under 750 ^c | 12-14 | 14-18 | b | 8-10 | 10-12 | 10-12 |
| | 750-1500 | 16-18 | 20-24 | b | 10-12 | 14-16 | 16-18 |
| | 1500-6000 | 20-22 | 24-30 | b | 14-16 | 16-18 | 20-22 |
| | Over 6000 | 22-24 | 26-32 ^a | b | 16-18 | 20-22 | 22-24 |
| 60 mph | Under 750 ^c | 16-18 | 20-24 | b | 10-12 | 12-14 | 14-16 |
| | 750-1500 | 20-24 | 26-32 ^a | b | 12-14 | 16-18 | 20-22 |
| | 1500-6000 | 26-30 | 32-40 ^a | b | 14-18 | 18-22 | 24-26 |
| | Over 6000 | 30-32 ^a | 36-44 ^a | b | 20-22 | 24-26 | 26-28 |
| 65-70 ^d mph | Under 750 ^c | 18-20 | 20-26 | b | 10-12 | 14-16 | 14-16 |
| | 750-1500 | 24-26 | 28-36 ^a | b | 12-16 | 18-20 | 20-22 |
| | 1500-6000 | 28-32 ^a | 34-42 ^a | b | 16-20 | 22-24 | 26-28 |
| | Over 6000 | 30-34 ^a | 38-46 ^a | b | 22-24 | 26-30 | 28-30 |

Source: AASHTO *Roadside Design Guide*, Chapter 3.

TABLE A-2-1

CLEAR ZONE DISTANCES (IN FEET FROM EDGE OF DRIVING LANE)*

- a. When a site specific investigation indicates a high probability of continuing crashes, or when such occurrences are indicated by crash history, the designer may provide clear zone distances greater than the clear zone shown in Table A-2-1. Clear zones may be limited to 30 feet for practicality and to provide a consistent roadway template if previous experience with similar projects or designs indicates satisfactory performance.
- b. Because recovery is less likely on the unshielded, traversable 3:1 fill slopes, fixed objects should not be present in the vicinity of the toe of these slopes. Recovery of high speed vehicles that encroach beyond the edge of shoulder may be expected to occur beyond the toe of slope. Determination of the width of the recovery area at the toe of slope should take into consideration right of way availability, environmental concerns, economic factors, safety needs, and crash histories. Also, the distance between the edge of the travel lane and the beginning of the 3:1 slope should influence the recovery area provided at the toe of slope. While the application may be limited by several factors, the fill slope parameters which may enter into determining a maximum desirable recovery area are illustrated in FIGURE A-2-4. A 10 foot recovery area at the toe of slope should be provided for all traversable, non-recoverable fill slopes.
- c. For roadways with low volumes it may not be practical to apply even the minimum values found in Table A-2-1. Refer to Chapter 12 for additional considerations for low volume roadways and Chapter 10 for additional guidance for urban applications in AASHTO *Roadside Design Guide*.
- d. When design speeds are greater than the values provided, the designer may provide clear zone distances greater than those shown in Table A-2-1.

* Rev. 1/16

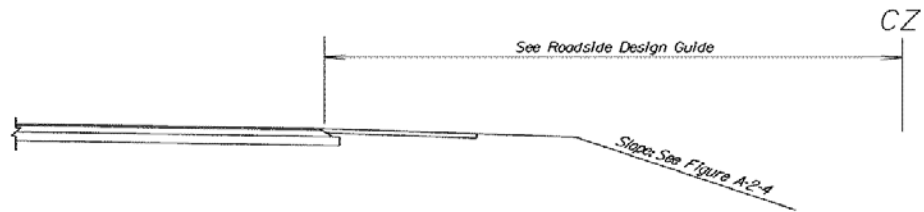

CASE 1

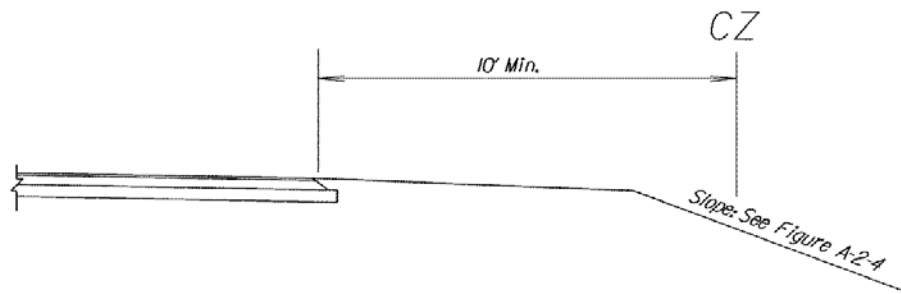

CASE 2

* 1.5' Absolute Minimum Lateral Offset In
Constrained Low-Speed Urban Environments.

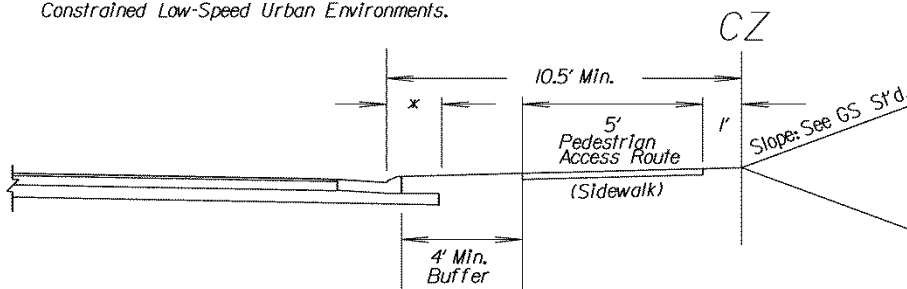

CASE 3 – CURB WITH BUFFER STRIP AND SIDEWALK

FIGURE A-2-1*

* Rev. 7/15

* 1.5' Absolute Minimum Lateral Offset in Constrained Low-Speed Urban Environments.

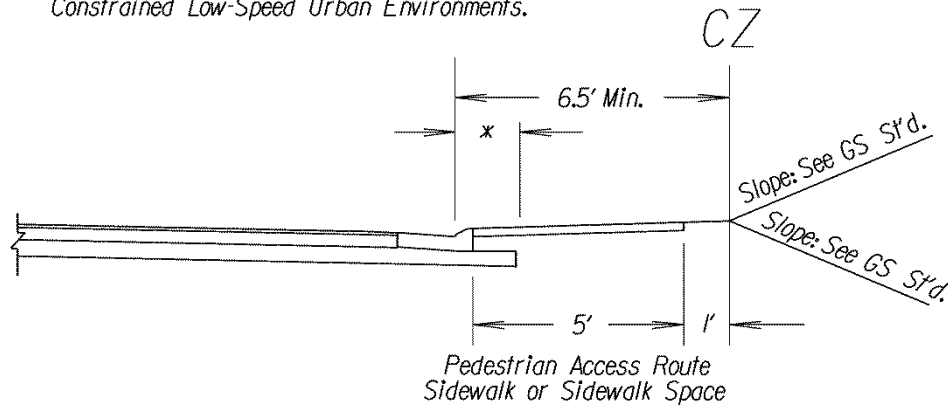

CASE 4 – CURB SIDEWALK OR SIDEWALK WITH SPACE*

* 1.5' Absolute Minimum Lateral Offset in Constrained Low-Speed Urban Environments.

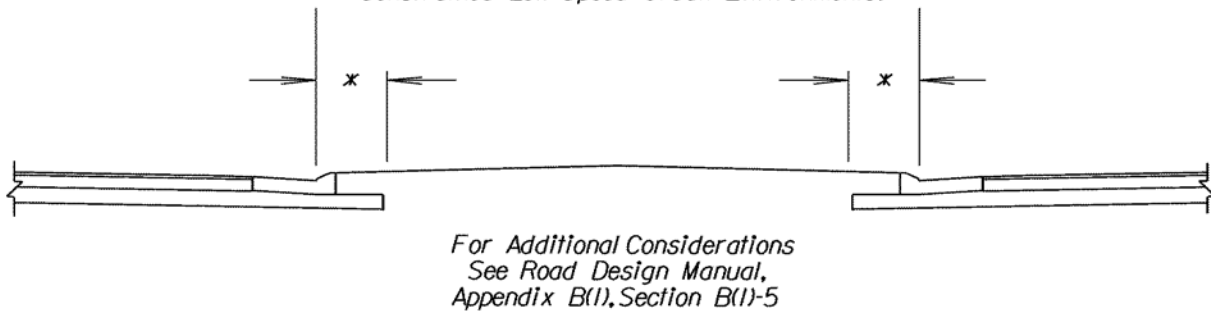

CASE 5 – CURBED MEDIAN
FIGURE A-2-1A

* Rev. 7/15

CLEAR ZONE COST-EFFECTIVENESS ANALYSIS

For projects where the clear zone widths from the AASHTO *Roadside Design Guide* are under consideration, Freeways; Rural and Urban Arterials (with shoulders); and Rural and Urban Collectors (with shoulders) with design speeds of 50 mph or greater and with a design year ADT greater than 2000, an early cost-effectiveness analysis is required to determine the feasibility of providing the recoverable areas to meet the clear zone requirements shown in TABLE A-2-1.

This analysis should be done during the preliminary plan development process and should involve determining the additional construction and R/W costs to provide the desired clear zone. Refer to AASHTO's *Roadside Design Guide*, Chapter 2, for "Economic Evaluation of Roadside Safety".* Any other procedure which will provide this cost is acceptable as long as it is documented in the project files. After the additional cost to provide the recoverable area is determined, it should be compared to the estimated accident cost without the recoverable area. This cost comparison along with good engineering judgment should be used to determine the feasibility of providing the recoverable areas through the project and should be documented on the Field Review and Scoping Report [PM-100](#).

Prior to establishing the additional construction and R/W cost estimate, the developed areas that would involve heavy R/W damages and/or relocations or environmental restrictions such as park properties, historic areas or wetlands should be noted and where practicable horizontal and vertical alignment adjustments are to be made to provide the desired recoverable areas and clear zones. In these situations alternate designs may include elimination of ditches and/or median width reductions with possible incorporation of raised medians or median barrier to reduce required R/W.

A suggested procedure is shown in FIGURE A-2-2 to develop the difference in cost between the typical section based on the project's functional classification and proper Geometric Design Standards and the typical section with the desired recoverable areas.

* Rev. 1/12

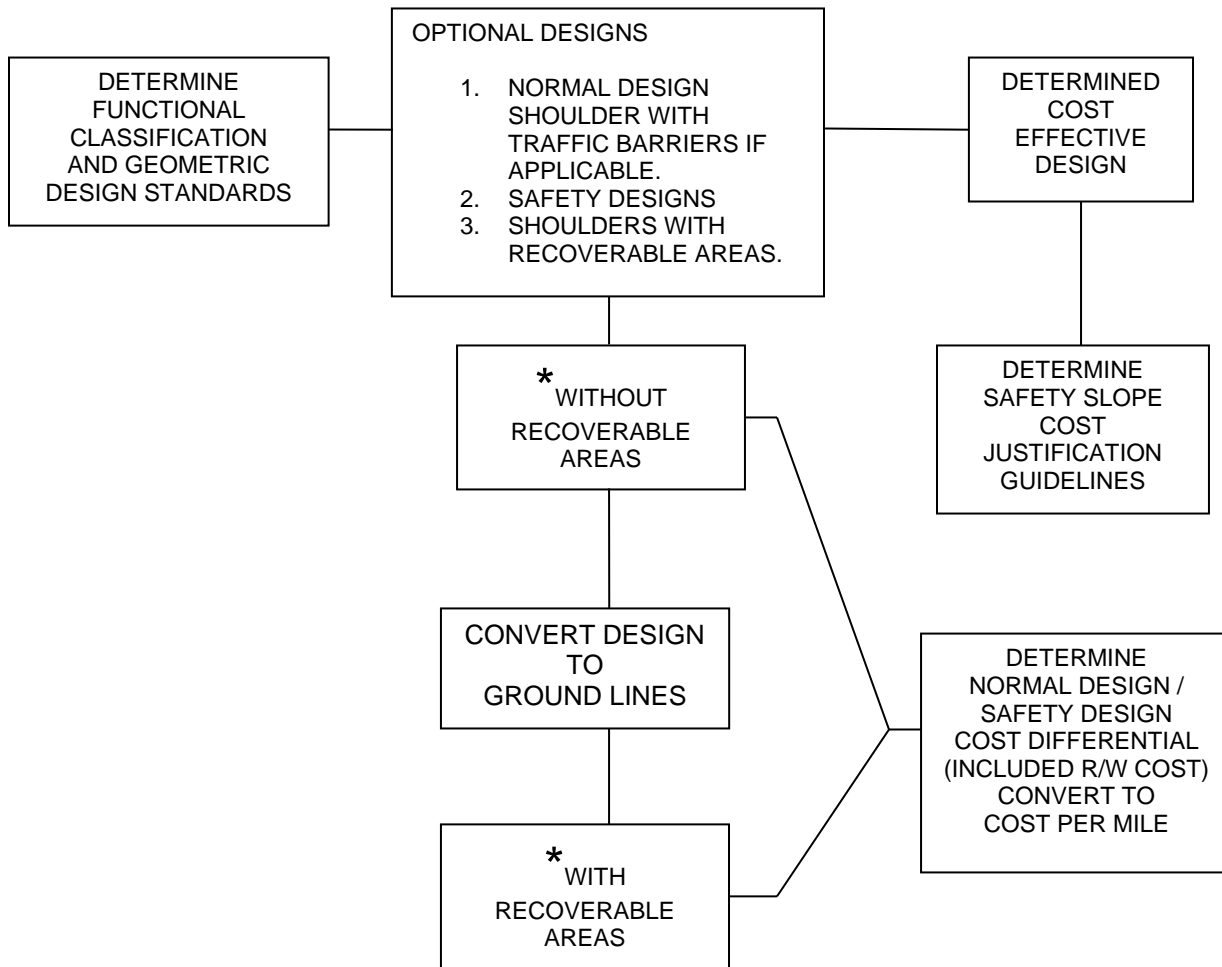

* GEOPAK DESIGN CROSS SECTION LISTING
EARTHWORK VOLUME COMPUTATIONS

FIGURE A-2-2
COST EFFECTIVE SELECTION PROCEDURES

Note: Upon receipt of normal design and safety design earthwork quantities, a cursory review may indicate that the cost per side for the earthwork alone far exceeds the cost per mile for safety slopes, thereby eliminating the need to determine the other additional costs such as drainage extensions, right of way, etc*.

EMBANKMENT SLOPES

Embankment slopes must have a relatively smooth and firm surface to be truly recoverable or traversable.

* Rev. 7/06

Fill slopes between 3:1 and 4:1 are traversable, but non-recoverable slopes, defined as one from which most motorists will be unable to stop or to return to the roadway easily. Vehicles on such slopes typically can be expected to reach the bottom. Since a high percentage of encroaching vehicles will reach the toe of these slopes, the recovery area cannot logically end on the slope. Fixed obstacles should not be constructed along such slopes and a clear runout area (10' min.) at the base is desirable. FIGURE A-2-4 provides an example of a clear zone computation for non-recoverable slopes.

Any non-traversable hazards or fixed objects, including but not limited to those listed in TABLE A-3-1, which are located within the clear zone as determined from TABLE A-2-1 should preferably be removed, relocated, made yielding, or as a last resort, shielded with a barrier.

HORIZONTAL CURVE ADJUSTMENTS

The distances in TABLE A-2-1 may be increased on horizontal curves by the values shown in TABLE A-2-2. See the AASHTO *Roadside Design Guide*, Chapter 3 for further instructions.

These modifications are normally considered where crash* histories indicate such a need, when a specific site investigation shows a definitive crash potential that could be significantly lessened by increasing the clear zone width, and when such increases are cost effective. In these situations, the clear zone distance is increased by the factor in the table below:

| RADIUS (ft) | DESIGN SPEED (mph) | | | | | | |
|----------------|--------------------|-----|-----|-----|-----|-----|-----|
| | 40 | 45 | 50 | 55 | 60 | 65 | 70 |
| 2950 | 1.1 | 1.1 | 1.1 | 1.2 | 1.2 | 1.2 | 1.2 |
| 2300 | 1.1 | 1.1 | 1.2 | 1.2 | 1.2 | 1.2 | 1.3 |
| 1970 | 1.1 | 1.2 | 1.2 | 1.2 | 1.3 | 1.3 | 1.4 |
| 1640 | 1.1 | 1.2 | 1.2 | 1.3 | 1.3 | 1.3 | 1.4 |
| 1475 | 1.2 | 1.2 | 1.3 | 1.3 | 1.4 | 1.4 | 1.5 |
| 1315 | 1.2 | 1.2 | 1.3 | 1.3 | 1.4 | 1.4 | - |
| 1150 | 1.2 | 1.2 | 1.3 | 1.4 | 1.5 | 1.5 | - |
| 985 | 1.2 | 1.3 | 1.4 | 1.5 | 1.5 | - | - |
| 820 | 1.3 | 1.3 | 1.4 | 1.5 | - | - | - |
| 660 | 1.3 | 1.4 | 1.5 | - | - | - | - |
| 495 | 1.4 | 1.5 | - | - | - | - | - |
| 330 | 1.5 | - | - | - | - | - | - |

TABLE A-2-2

Source: AASHTO *Roadside Design Guide*, Chapter 3

$$CZ_c = (L_c) (K_{cz})$$

Where

CZ_c = clear zone on outside of curvature, ft.

L_c = clear zone distance ft., Table A-2-1

K_{cz} = curve correction factor

Note: Clear zone correction factor is applied to outside of curves only. Curves flatter than 2950 feet don't typically require an adjusted clear zone.

* Rev. 1/12

SHOWING CLEAR ZONES/ LATERAL OFFSETS ON TYPICAL SECTIONS

The clear zone width(s) shall be clearly shown on the project typical sections if traversable slopes are being provided so that other divisions will be aware of the desirable clear zones for a project. When varying clear zone widths occur, furnish station to station breakdown. Following are typical methods of showing clear zone/lateral offset* data on typical sections.

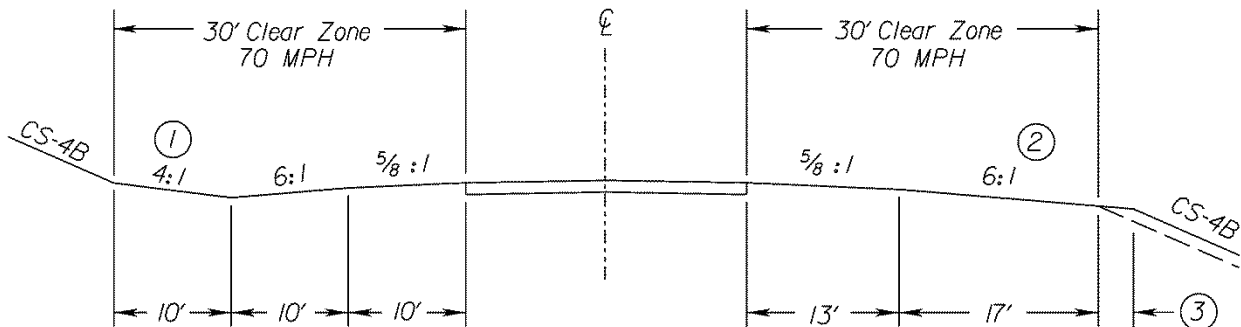

EXAMPLE OF A TYPICAL RURAL SECTION

(Other Principal Arterial - Std. CS- 4B used for example)

Design ADT > 6000

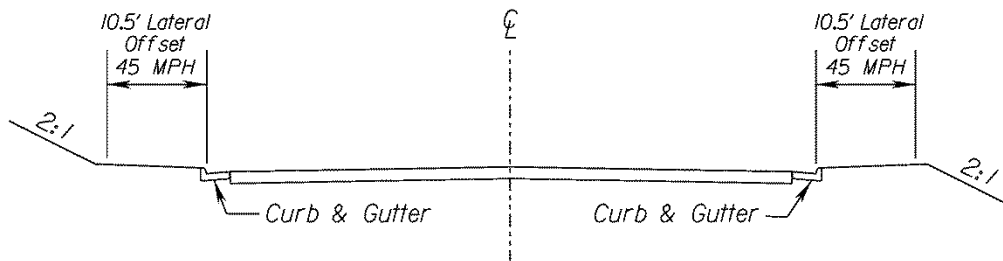

EXAMPLE OF A TYPICAL URBAN SECTION

(Minor Arterial Street used for example)

TYPICAL METHOD OF SHOWING CLEAR ZONE/ LATERAL OFFSET DATA ON TYPICAL SECTIONS

NOTES:

1. If the front slope of ditch is 6:1, the back slope should be 4:1, and if the front slope is 3:1, the back slope should be flat.
2. The preferred slope for recoverable areas with fills is 6:1 or flatter.
3. Width to be increased 3' when Guardrail is required.

* Rev. 7/13

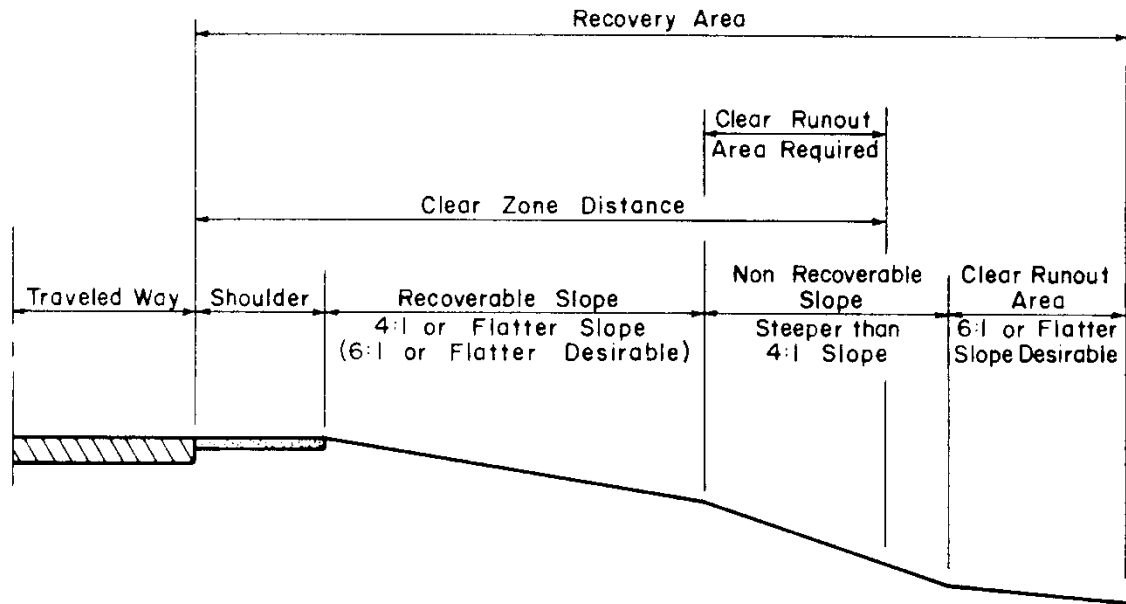

FIGURE A-2-4 EXAMPLE OF A PARALLEL EMBANKMENT SLOPE DESIGN

Source: AASHTO *Roadside Design Guide*, Chapter 3

This figure illustrates a recoverable slope followed by a non-recoverable slope. Since the clear zone distance extends onto a non-recoverable slope, the portion of the clear zone distance on such a slope may be provided beyond the non-recoverable slope if practical. This clear runout area would then be included in the total recovery area. The clear runout area may be reduced in width based on existing conditions or site investigations. Such a variable slope typical section is often used as a compromise between roadside safety and economics. By providing a relatively flat recovery area immediately adjacent to the roadway, most errant motorists can recover before reaching the steeper slope beyond. The slope break may be liberally rounded so an encroaching vehicle does not become airborne. It is suggested that the steeper slope be made as smooth as practical and rounded at the bottom.

NON-RECOVERABLE PARALLEL SLOPES

Foreslopes* from 3:1 up to 4:1 are considered traversable if they are smooth and free of fixed object hazards. However, since many vehicles on slopes this steep will continue on to the bottom, a clear run-out area beyond the toe of the slope is desirable. The extent of this clear run-out area could be determined by first finding the available distance between the edge of the through traveled way and the breakpoint of the recoverable foreslope to the non-recoverable foreslope. This distance is then subtracted from the total recommended clear zone distance based on the slope that is beyond the toe of the non-recoverable foreslope and should be at least 10' if practicable. The result is the desirable clear run-out area. The following example illustrates this procedure:

EXAMPLE

Design ADT: 7000

Design Speed: 60 mph

Recommended clear zone distance for the 8:1 slope: 30-32 feet (from
TABLE A-2-1)

Recovery distance before breakpoint of non-recoverable foreslope: 17 feet

Clear run-out area at toe of slope: 30-32 feet minus 17 feet or 13-15 feet

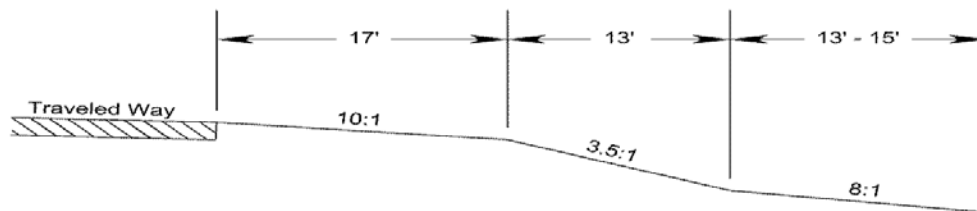

(For Example of Alternate Design to reduce CZ requirement, see below)

Discussion: Using the steepest recoverable foreslope before or after the non-recoverable foreslope, a clear zone distance is selected from Table A-2-1. In this example, the 8:1 slope beyond the base of the fill dictates a 30-32 foot clear zone area. Since 17 feet is available at the top, an additional 13-15 feet could be provided at the bottom. Since this is less than the 10' recovery area that should be provided at the toe of all the non-recoverable slopes, the 10' should be applied. All foreslope breaks may be rounded and no fixed objects would normally be built within the upper or lower portions of the clear zone or on the intervening foreslope.

The designer may find it safe and practical to provide less than the entire 13-15 feet at the toe of the slope. A smaller recovery area could be applicable based on the rounded slope breaks, the flatter slope at the top or past accident histories. A specific site investigation may be appropriate in determining an appropriate recovery area at the toe of the slope.

* Rev. 7/13

**EXAMPLE OF ALTERNATE DESIGN (INCORPORATING MINOR SLOPE ADJUSTMENT)
TO REDUCE TOTAL CLEARANCE REQUIREMENT:**

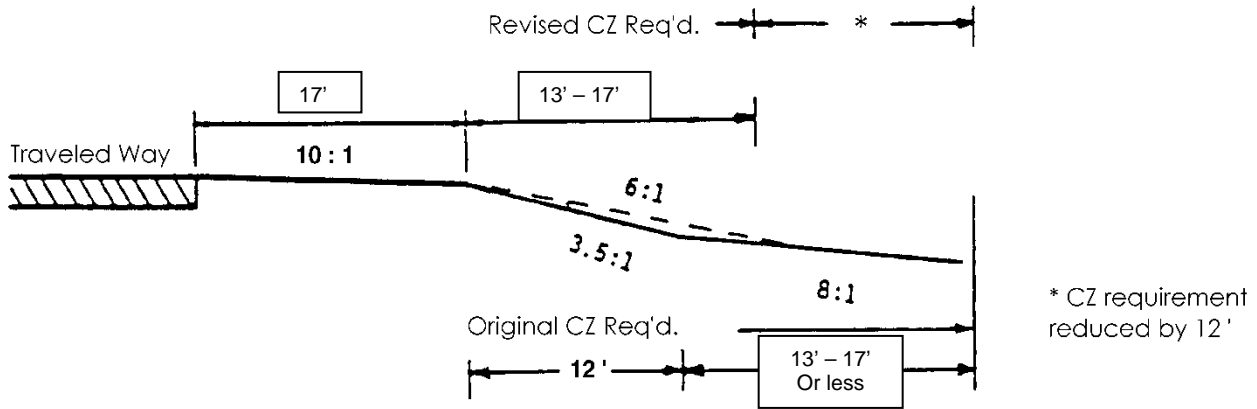

Source: *Roadside Design Guide*, Chapter 3

When traffic barriers must be provided because hazardous conditions cannot be eliminated, see **Appendix I** - Barrier Installation Criteria.

* Rev. 1/15

SECTION A-3-TRAFFIC BARRIER INSTALLATION CRITERIA

[THIS INFORMATION IS NOW LOCATED IN APPENDIX I IN THE ROAD DESIGN MANUAL.](#)*

SECTION A-4-GUIDELINES FOR RRR PROJECTS

OBJECTIVE

The objective of the Virginia RRR Guidelines is to provide guidelines in the selection of projects where, with minimal improvements, the service life of the existing highway can be extended for a fraction of the cost of complete reconstruction.

Resurfacing, restoration, and rehabilitation (RRR) projects primarily involve work on an existing roadway surface and/or subsurface. In addition to extending the service life of the roadway, the purpose of RRR projects includes providing additional pavement strength, restoring or improving the existing cross section, decreasing noise characteristics, improving the ride of the roadway, improving bridges, and enhancing safety through the implementation of appropriate safety improvements, bridge improvements and preventive maintenance of bridges on appropriate Federal-Aid roadways. Highway Bridge Replacement and Rehabilitation Program (HBRRP) Funds may be utilized for preventative maintenance (PM) for the purpose of system preservation activities on Federal-Aid roadways except for those classified as local roads or rural minor collectors. Routine maintenance remains the responsibility of VDOT and/or locality.*

Section 309 of the National Highway System Designation Act of 1995 (23 USC 116) states: "A preventive maintenance activity shall be eligible for Federal assistance under this title if the State demonstrates through the use of a systematic process, such as a Bridge Management System, to the satisfaction of the Secretary that the activity is a cost-effective means of extending the useful life of a Federal-Aid highway."

The scope of a RRR project is influenced by many factors. Factors include roadside conditions, environmental concerns, changing traffic and land use patterns, surface deterioration rate, accident rates, funding constraints and scenic/historic areas.

Although RRR type improvements are normally accomplished within the existing right of way, the acquisition of additional right of way may be necessary. Horizontal and vertical alignment modifications, when required, are generally minor.

AUTHORITY

The Transportation Research Board's *Special Report 214, Designing Safer Roads, Practices for Resurfacing, Restoration, and Rehabilitation, 1987*, was the result of a study on safety cost-effectiveness of highway geometric design standards for RRR projects. Virginia has developed and adopted this guideline for non-NHS RRR projects.

In the planning and design of any Secondary System improvements in rural areas, Virginia's RRR Guidelines shall be utilized to the extent possible.

* Rev. 1/06

Reconstruction under AASHTO design guidelines should be proposed on these projects only when the preliminary study report documents either:

1. The needed improvement is ineligible for development under the RRR concept.
or
2. Extenuating circumstances preclude the use of the RRR Design concept.

Virginia RRR Guidelines may be utilized in improvements to urban streets for which the localities receive maintenance payments.

DEFINITIONS

These definitions apply to RRR projects and are not an attempt to be all-inclusive of other related activities.

Maintenance - This work is directed toward preservation of the existing roadway and related appurtenances as necessary for safe and efficient operation. Design improvements are not normally the intent of maintenance operations. Seal coats, overlays less than 2 inches* thick, crack sealing, etc., are considered maintenance items, and are not RRR activities.

Resurfacing - The addition of a layer, or layers, of paving material to provide additional structural integrity or improved serviceability and ride ability.

Restoration - Work performed on pavement, or bridge decks, to render them suitable for an additional stage of construction. This may include supplementing the existing roadway by increasing surfacing and paving courses to provide structural capability, and widening up to a total of ten feet. Restoration will generally be performed within the existing right of way.

Rehabilitation - Similar to "Restoration", except the work may include restoring structural integrity or correcting major safety defects of bridges, reworking or strengthening the base or subbase, recycling or reworking existing materials to improve their structural integrity, adding underdrains, improving or widening shoulders, and shifts in both vertical and horizontal alignment involving less than 50 percent of the project length. Rehabilitation may require acquisition of additional right of way.

* Rev. 1/10

Reconstruction - This type of project is not considered RRR activity. A reconstruction project is designed in accordance with AASHTO design guidelines for new and major reconstruction projects and may include significant changes in cross section and shifts in both vertical and horizontal alignment. If 50 percent or more of the alignment changes, the project will be considered reconstruction. Reconstruction may require acquisition of additional right of way and may include all items of work usually associated with new construction.

PROJECT SELECTION

Projects are identified and selected based on a variety of factors with the pavement condition being of utmost importance. The pavement condition itself will not have a significant effect on the extent of geometric improvements included in the project. Geometric improvements will be initiated to fulfill traffic service/safety needs.

Logical project termini are to be set; and, at no time, are project exceptions for segments of roadway or bridge, etc., to be established within the project termini due to excessive cost to provide the required improvements.

ELIGIBILITY

Improvements to Existing Roadway*:

Eligible Items of Work *

- Minor alterations to vertical and/or horizontal alignment.
- Minor lane and/or shoulder widening.
- Pavement structure and joint repair.
- Resurfacing (non-maintenance activities).
- Removal or protection of roadside obstacles.
- Repairs to restore bridge structural integrity, installation of deck protective systems and upgrading substandard bridge rail.
- Culvert Extensions.
- Repair or replace culverts.
- Restoration & relocation of curbs and gutters, raised medians, storm sewers, and other urban type improvements.

* Rev. 1/06

- Some RRR-type projects may be funded with either regular Federal-Aid or separate categorical aid.

Examples:

Bridge rehabilitation project - RRR funding or the bridge replacement and rehabilitation program.

Roadside hazard removal and guardrail installation - RRR funding or hazard elimination program funds.

Ineligible Items of Work

- National Highway System (NHS). However some projects may be eligible, see “PREVENTIVE MAINTENANCE (PM) PROJECTS / RRR PROJECTS UTILIZING FEDERAL FUNDING ON NATIONAL HIGHWAY SYSTEM (NHS) ROADWAYS” at the end of Section A-4 for guidelines.
- New or additional through lanes.
- New Curbs and gutters, raised medians, storm sewers, and other new urban type improvements.

ACCIDENT RECORDS

Evaluation of accident records often reveals problems requiring special attention. In addition, relative accident rates can be an important factor in establishing both the priority and the scope of RRR projects.

The Project Manager must request from the Traffic Engineering Division that the accident history for the project area be compiled and compared to the statewide average accident rate for the same type of road. This data review can be an integral part of the RRR project development process so that feasible safety modifications can be incorporated into the project as necessary.

The accident analysis shall be completed prior to the project field inspection/review and available for field review by the Federal Highway Administration.

BRIDGE REHABILITATION OR REPLACEMENT SELECTION POLICY

See VOLUME V – PART 2 DESIGN AIDS AND TYPICAL DETAILS, Chapter 6 – Geometrics, which can be accessed at <http://www.virginiadot.org/business/bridge-manuals-default.asp>.

* Rev. 1/12

ENVIRONMENTAL CONSIDERATIONS

An environmental evaluation and documentation thereof, is required on all RRR Federal participation projects in accordance with current guidelines.

Prints are transmitted to the Environmental Engineer via Form [LD-252](#).

ACCESS CONTROL

Generally, a RRR project will not be designated as a [limited access](#) highway due to the project being along an existing corridor with access provided to adjoining properties.

The elimination of existing access to properties is beyond the scope of work for RRR projects.

Existing limited access roadways may qualify as a RRR project.

PROJECT DEVELOPMENT

It is desirable that these projects be designed to meet the standards for new construction. If meeting these standards is not practical, due to limited funding, right of way and/or environmental restrictions, etc., improvements in roadway widths should still be considered.

The design should not decrease the existing geometrics. Widths selected should be consistent throughout a given section. Minor lane and shoulder widening is acceptable. While additional new continuous traffic lanes are an ineligible type of work, the existing pavement may be widened up to a total of ten feet.

ROADWAY AND TRAVELWAY WIDTHS

The minimum roadway and travelway widths are shown under GEOMETRIC DESIGN CRITERIA, TABLE A-4-1. Lane and shoulder width requirements are provided for roadways with 10% or more trucks and for roadways with less than 10% trucks.*

Wide lanes and shoulders provide motorists with increased separation between overtaking and meeting vehicles and an opportunity for safe recovery of vehicles leaving the road.

Additional safety benefits include reduced interruption of the traffic flow as the result of emergency stopping and road maintenance activities, less pavement and shoulder damage at the lane edge, and improved sight distance for horizontal curves.

* Rev. 7/12

DESIGN TRAFFIC VOLUMES

Traffic projections should be checked to assure that:

The anticipated traffic being used is correct and that the roadway and travelway needs will be properly accommodated for the service life of the improvement.

The project service life for RRR projects should be from 8 to 12 years.

Turning movements are obtained at signalized and problem intersections and at major traffic generators.

Future traffic generators that are anticipated to be established during the service life should be considered.

DESIGN SPEED

The design speed designated for a RRR project should be logical with respect to the character of terrain and type of highway and should be as high as practicable.

It is also important to consider the geometric conditions of adjacent sections of roadway when considering a RRR project. A uniform design speed should be maintained for a significant section of highway.

The design speed is a determining factor for required lane and shoulder widths. The following two methods may be used to determine the project design speed:

- (1) Select an overall project design speed that equals or exceeds the posted or regulatory speed on the section of highway being improved.
- (2) The average running speed throughout the project based on the "low volume" off peak hour traffic.

Average running speed is the speed of a vehicle over a specified section of highway, being the distance traveled divided by the running time (the time the vehicle is in motion).

An equivalent average running speed can be obtained on an existing facility where flow is reasonably continuous by measuring the spot speed.

The average spot speed is the arithmetic mean of the speeds of all traffic at a specified point.

For short sections of highway on which speed characteristics do not vary materially, the average spot speed may be considered as being representative of the average running speed.

On longer stretches of rural highway, spot speeds measured at several points, where each represents the speed characteristics pertinent to a selected segment of highway, may be averaged (taking relative lengths into account) to represent the average running speed.

TERRAIN

Terrain is a significant factor which must be given strong consideration when establishing design criteria for a highway project. High design speeds (50 MPH and greater) can generally be achieved on flat terrain, and lower design speeds (45* MPH and lower) are generally dictated by rolling and mountainous terrain, (depending upon road classification). Intermediate design speeds are determined by a combination of these factors.

While terrain is an important factor to be considered when designing a new project, RRR projects must be designed considering all existing constraints, and held within RRR parameters. That is to say that eligible RRR elements, due to terrain and other constraints upon the original design, may not allow the desired speed and safety enhancements.

SAFETY

All safety elements of the project are to be given specific consideration. Accidents, accident types, and accident rates for the project length shall be examined and documented.

The documentation may indicate deficiencies in one or more of the following areas, however, each should be examined:

- Horizontal and vertical alignment
- Cross-sectional geometrics
- Traffic control
- Access
- Railroad crossings
- Pedestrian facilities
- Bridges that remain in place
- Illumination
- Signing
- Channelization
- Intersections
- Pavement edge drop offs
- Pavement surface condition
- Maintenance of traffic
- Bicycle facilities

Improvements to the roadway surface may result in increased operating speeds. Geometrics should be examined and modified, if necessary, to maintain an acceptable level of operational safety.

Horizontal and vertical curvature and stopping sight distance are directly related to the speed of vehicles and major deviations from the desirable design may cause serious problems. These geometric characteristics can be the most difficult and costly to improve. Although every sight distance restriction can create a potential hazard, improvement on that basis alone may not be practical on every RRR project.

* Rev. 7/12

If curvature is shown to be the cause of numerous accidents, some corrective action should be taken. This corrective action can range from some form of positive guidance, which may include placement of additional warning signs and markings, to reconstruction.

Alignment improvements should be undertaken when accident experience is high, and if previously installed warning signs, markings, or other devices have not proven effective. In many cases, under both rural and urban conditions, existing horizontal and vertical alignments may be retained if a careful analysis indicates they can be adequately signed and marked.

Sight distance on horizontal curves, and at intersections, can often be improved by minor cut slope flattening, selective clearing or both. If such work is done, the actual sight distance must be measured, the maximum safe speed determined, and the location signed and marked accordingly.

A completed **Roadside Safety Assessment** is required **to be performed by the Regional Traffic Engineer.*** This will provide information regarding areas of potential concern relating to safety.

For safety, it is desirable to provide a roadside recovery area that is as wide as practical, but because of existing topographic features and right of way limitations associated with RRR work, considerable judgment must be used. The clear zone must be given particular attention at identified high roadside accident locations (fixed object and run-off-the-road accidents). An evaluation should be made to determine the consistency of the clear zone throughout the project limits.

Widening to provide more clear distance through short sections of rock cuts should be considered. In longer rock cuts, protrusions should be cut back or shielded if warranted. A review of accident data will help to define dangerous obstructions. Good engineering judgment, cost effectiveness, and consideration of community impact may also influence decisions.

* Rev. 7/12

Under urban conditions the minimum setback for any obstructions should be as close to the right of way line as possible or 1.5 feet behind the curb. Where sidewalks are to be included, it is desirable to locate all obstructions behind the sidewalk.

Safety items for reducing the severity of run-off-the-road accidents include traffic barriers (including bridge rails), flattening slopes to eliminate the need for either existing barrier or contemplated barrier placement, crash cushions, breakaway or yielding sign supports, and breakaway luminaire supports.

The priority for action relative to roadside hazards is to:

- Remove or redesign
- Relocate
- Make breakaway
- Redirect by using appropriate barrier
- Delineate

To enhance safety, all RRR projects should provide the following:

Evaluation of existing traffic barrier and end treatments to determine whether they are necessary and meet applicable guidelines and standards. The extent to which the barrier must be upgraded should be consistent.

Appropriate transition and connection of approach rail to bridge rail.

Mitered end sections for both parallel and cross-drain structures located in the clear zone.

Relocating, shielding, or providing breakaway features for sign supports and luminaires.

Protection for exposed bridge piers and abutments.

Drop inlets with traversable grates that are not a hazard to be used within the clear zone.

GEOMETRIC DESIGN CRITERIA

The design criteria in Table A-4-1 for Minor Arterial, Collector and Local Road projects are based on the general approach in the "AASHTO Book" regarding functional classification and corresponding appropriate design volumes and also recommendations presented in TRB special Report 214, Practices for Resurfacing, Restoration, and Rehabilitation.

| MINIMUM LANE AND SHOULDER WIDTH VALUES | | | | | | | | |
|--|------------------|------------------------|--------------|--------------------|--------------------------|-----------|--------------------|-----------------------------|
| ARTERIAL/ COLLECTOR/ LOCAL ROAD AND STREET SYSTEMS | | | | | | | | |
| DESIGN TRAFFIC VOLUME | DESIGN SPEED MPH | 10% OR MORE TRUCKS (d) | | | LESS THAN 10% TRUCKS (d) | | | DITCH WIDTH 3:1 FRONT SLOPE |
| | | LANE WIDTH | | SHOULDER WIDTH (c) | LANE WIDTH | | SHOULDER WIDTH (c) | |
| ADT (a) | (b) | C&G (FT.) | W/SHLD (FT.) | | (FT.) | C&G (FT.) | | W/SHLD (FT.) |
| 1 - 750 | < 50 | 11 (e) | 10 (e) | 2 (i) | 10 | 9 | 2 (i) | 3 (h) |
| | ≥ 50 | 11 | 10 | 2 (i) | 11 | 10 | 2 (i) | 3 (h) |
| 751 - 2000 | < 50 | 11 | 11 (f) | 2 (i) | 11 | 10 | 2 (i) | 3 |
| | ≥ 50 | 12 | 12 (g) | 3 (i) | 11 | 11 | 3 (i) | 3 |
| 2001 - 4000 | ALL | 12 | 12 | 6 | 11 | 11 | 6 | 4 |
| 4001 - OVER | ALL | 12 | 12 | 6 | 11 | 11 | 6 | 4 |

TABLE A-4-1 GEOMETRIC DESIGN CRITERIA

- (a) Design traffic volume is between 8 and 12 years from completion.
- (b) Highway segments should be classified as "Under 50" only if most vehicles have an average running speed of less than 50 MPH over the length of the segment.
- (c) Cut shoulder width may be reduced by one foot in mountainous terrain.
- (d) Trucks are defined as heavy vehicles with six or more tires.
- (e) Use 9' lane width for Rural/Local Road System with ADT of 1 - 250.
(9' lane width is equal to new construction standards for Rural/Local Road System)
Use 10' lane width with Curb and Gutter for Urban with ADT 1-250
(10' lane width is equal to new construction standards)
- (f) Use 10' lane width for Collector Road and Local Road System in mountainous terrain. (10' lane width is equal to new construction standards.)
- (g) Use 11' lane width for Collector Road and Local Road System in level terrain. (11' lane width is equal to new construction standards.)
- (h) Use 2' ditch width with pavement depths (excluding cement stabilized courses) of 8" and less.
- (i) Minimum width of 4' if roadside barrier is utilized (minimum 2' from edge of pavement to face of G.R.).
(See Guardrail Installation Standard, Section 500, in VDOT Road and Bridge Standards).

NOTE: PAVEMENT AND SHOULDER WIDTHS NOTED ARE MINIMUMS FROM A DESIGN CRITERIA STANDPOINT. UNDER NO CIRCUMSTANCES SHALL THE EXISTING PAVEMENT OR SHOULDER WIDTHS BE REDUCED TO CONFORM TO THESE MINIMUM STANDARDS.

NOTE: FOR VALUES NOT SHOWN, SEE APPROPRIATE GEOMETRIC DESIGN STANDARD FOR THE FUNCTIONAL CLASSIFICATION OF ROADWAY (GS-2, GS-3 OR GS-4) CONTAINED IN THE VDOT ROAD DESIGN MANUAL, APPENDIX A, SECTION A-1.

NOTE: ROADSIDE HAZARDS AND PRIORITY FOR RELATIVE ACTION ARE COVERED ON PAGE A-33.

CLEAR ZONES AND SLOPES

Wherever possible, existing side slopes should not be steepened when widening lanes and shoulders. When the initial slopes are relatively flat, however, the slope can be steepened to 6:1 with little effect, and steepening to 4:1 may be reasonable.

Consideration should be given to flattening side slopes of 3:1 or steeper at locations where run-off-the-road type accidents are likely to occur (e.g. on the outsides of horizontal curves). Accident data should be used (when available) to substantiate run-off-the-road accident locations.

Removing, relocating or shielding of isolated roadside obstacles should be evaluated in accordance with the Clear Zone and Traffic Barrier Guidelines contained in the Road Design Manual, Appendix A, Sections A-2 and A-3.

GRADES

Grades generally do not need to be flattened on RRR projects. Steep grades and restricted horizontal or vertical curvature in combination, however, may warrant corrective action.

CREST VERTICAL CURVES

An existing vertical curve may be retained as is, without further evaluation, if the existing design speed provides the stopping sight distance within 15 MPH of the overall project design speed and the average daily traffic volume is less than 750 vehicles per day.

Reconstruction of crest vertical curves is to be evaluated when the above speed and traffic volumes are exceeded and the vertical curve hides major hazards from view. Major hazards include, but are not limited to intersections or entrances, sharp horizontal curves and narrow bridges.

SAG VERTICAL CURVES

Substandard sag vertical curves should be investigated to ensure that potential hazards do not exist, especially ones that become apparent when weather conditions, or darkness, reduce visibility.

STOPPING SIGHT DISTANCES

Guidelines for determining the existing sight distances of vertical and horizontal curves are as follows:

- Existing road data to be determined from survey plan and profile sheets and/or old plans obtained from the plan library.
- Road and Bridge Standards [SD-1](#) and [SD-4](#) may be used to determine the sight distances using the following methods:

Vertical curves - Determine algebraic differences of grades in percent and length of vertical curve in feet from the survey plans, or old project plans, and the sight distance may be obtained from Standard [SD-4](#).

Horizontal curves - Determine the existing degree of curve and the middle ordinate or radial distance from centerline of inside lane to obstruction to view and the sight distance may be obtained from Standard [SD-1](#).

- Vertical and horizontal curve sight distances may be scaled from the plans using the following heights of driver's eye and object:

| <u>Sight Distance</u> | <u>Height of Eye</u> | <u>Height of Object</u> |
|-----------------------|----------------------|-------------------------|
| Stopping | 3.5' | 2' |
| Passing | 3.5' | 3.5' |

HORIZONTAL CURVES

An existing horizontal curve may be retained as is, without further evaluation, if the existing curve design speed, with correct superelevation provided, corresponds to a speed that is within 15 MPH of the running speeds of approaching vehicles and the average daily traffic volume is less than 750 vehicles per day.

Reconstruction of horizontal curves should be considered and evaluated when the above speed and/or volume criteria are exceeded.

When a roadway segment consists of a series of reverse curves or curves connected by short tangents, the succession of curves shall be analyzed as a unit rather than as individual curves.

The first substandard curve in a series should receive special attention because this change in alignment prepares the driver for the remaining curves in the series.

Any intermediate curve in a series of substandard curves that is significantly worse than the others in the series should be analyzed individually.

These controlling curves can be used to determine the safety and/or other mitigation measures to apply throughout the series.

PAVEMENT CROSS SLOPE

Pavement resurfacing or rehabilitation will be accomplished such that the finished pavement on tangent sections will be crowned in accordance with new construction standards.

SUPERELEVATION REQUIREMENTS

Standard superelevation will be provided on all curves to comply with the project design speed unless the following conditions exist:

- Excessive cost to provide superelevation.
- Excessive property damage.

Superelevations may be provided for design speeds up to a maximum of 15 MPH less than the project design speed for current traffic volumes of 750 vehicles per day or less, if the above conditions exist, with appropriate signing:

- Advisory curve signs and speed limit signs will be erected.

PAVEMENT EDGE DROP

Pavement edge drops usually are caused by resurfacing of pavement without regrading the existing shoulder or erosion of gravel, turf, or earth shoulder materials.

This hazard shall be eliminated or mitigated by utilizing one or more of the following practices:

- Paving the full top width between shoulder breaks.

- Selectively paving shoulders at points where vehicle encroachments are likely to create pavement edge drops, such as on the inside of horizontal curves.

- Constructing a beveled or tapered pavement edge so that any edge drop that develops has a reduced impact on the recovery maneuver.

- Reconstruction of shoulders.

INTERSECTIONS

Many intersection improvements can be made at a relatively low cost and are safety cost-effective, particularly at higher traffic volumes.

The intersection improvements must be tailored to site-specific conditions and rely heavily on professional judgment and experience along with current Department guidelines.

DESIGN EXCEPTIONS

All efforts should be made to adhere to the standards stated herein. However, under unusual conditions, it may be necessary to use values that are less than the minimum values shown. If lesser values are proposed for use, a design exception* will be needed and approval by the State Location and Design Engineer and the Federal Highway Administration on Federal aid funded projects must be granted before developing the project further.

Methods of showing design exceptions on the plans are noted in Instructional and Informational Memorandum IIM-LD-227. Design Exceptions are to be requested on Form LD-440, maintained on the VDOT website at <http://vdotforms.vdot.virginia.gov/>. If approved, the completed Form LD-440 is to be attached to Form LD-430 Scoping Report for submittal at advertisement stage.

PLANNING DRAINAGE DESIGN ELEMENTS

The hydraulic consequences of a highway improvement need to be addressed during the planning phase of the project.

Failure to assess the hydraulic aspects of the improvement could result in an increase in damages to adjacent property as well as the highway facility. Although detailed site information may not be required, it is important that a hydraulic assessment be made by a drainage engineer in the planning phase to determine that engineering and regulatory constraints can be met.

Items to be considered include:

- Hydraulic impacts
- Interaction with other agencies
- Utilities
- R/W and property owners' concerns
- Environmental concerns and permits

REPLACEMENT OR REHABILITATION OF DRAINAGE ELEMENTS

The decision to rehabilitate or replace a structure should not be made without checking hydraulic adequacy. Normally, the highway designs that improve upstream flooding conditions should generally result from meeting highway flooding criteria. Scour protection, spur dikes, or other protective measures should be included with the bridge rehabilitation.

The decision regarding the rehabilitation or replacement of existing bridges or culverts is often a structural or functional decision. Hydraulic input is important when the cost of the rehabilitation is high enough to consider replacement or where the contemplated rehabilitation involves a change in the roadway profile which, by lessening roadway overflow, could increase hydraulic stresses on the structure and change flow distribution.

* Rev. 1/14

Rehabilitation or replacement of culverts often becomes necessary when the culvert is no longer structurally sound. Consideration of the remaining service life of the existing culvert is, therefore, a very important factor in deciding to rehabilitate or to replace it.

In some instances, structures may require replacement due to inadequate waterway area and subsequent frequent interruption of traffic due to flooding. Prolonged ponding behind an embankment caused by an inadequate culvert may also lead to embankment saturation or piping along the culvert.

HYDRAULIC CHARACTERISTICS

The hydraulic considerations for RRR improvement projects are, in many respects, the same as those for a highway on new alignment. The primary difference is that the hydraulic characteristics of the existing facility are already established. These hydraulic characteristics include:

- Culvert performance (inlet or outlet control or headwater at culvert sites).
- Culvert outlet velocities and scour tendencies.
- Flow lines and culvert alignment.
- Backwater at bridge sites.
- Flow distribution.
- Scour patterns at bridge piers, bridge abutments and adjacent banks.
- Skew and channel alignment.
- Storm drain systems and their performance.

The engineer must consider the need for changing and the consequences of changes to these hydraulic characteristics.

Most improvement projects will require some modification of the existing drainage structures. If the hydraulic performance of a drainage structure is changed, the change should be investigated for both upstream and downstream effects of the change.

Because the hydraulic effects of existing structures are usually well established, there is sometimes opposition to change from the landowner(s) affected. This is particularly true in developed areas.

Debris conditions may be changed and should be considered in design. Roadside ditch drainage patterns may be altered. These conditions should be thoroughly studied before any change is allowed.

SAFETY IMPROVEMENTS RELATIVE TO DRAINAGE DESIGN

Where the hazard is a culvert headwall, the options usually are to extend the culvert, protect traffic with guardrail, or construct a protective grate over the headwall. The alternative selected should be based on particular site conditions. Grates on cross culverts with the potential to collect significant debris are undesirable because of the potential hazard created for local flooding. A good way to evaluate the risk is to assume the grate will be plugged and then determine what flood hazard will be created. In all cases, it is very important that grates on culvert end be inspected frequently and always cleared of debris. Spaces between grate bars should be as large as practicable in order to lessen the probability of plugging.

The wide openings tend to minimize the flood hazard by reducing the potential of debris plugging the culvert.

BRIDGE RESTORATION

Hydraulically Equivalent Replacement Structure (HERS) definition:

The waterway opening of the proposed structure provides the same height, width obstructions (piers) and geometric configuration as the existing structure.

The proposed roadway grades on the approaches and the structure provide the same overtopping characteristics as the existing facility.

Any of the above characteristics of the proposed facility are less restrictive to the passage of flood flows than are the characteristics of the existing facility.

Every waterway crossing whose 1% exceedance probability discharge is anticipated, estimated or expected to be 500 cfs or greater **MUST** be reviewed by an appropriate river mechanics specialist. When the proposed facility is determined to be the hydraulic equivalent of the existing facility, no formal design analysis will be required.

If a rehabilitation of the structure and/or its approach roadway does not conform to the HERS requirements, it must be treated as a bridge replacement, and an engineering analysis is required.

BRIDGE REHABILITATION

Bridge repairs are often required because of structural deterioration, damage from floods, and damage from vehicles. Bridge rehabilitation consists of physical changes to a bridge which are necessary because of inadequate width, structural capacity, hydraulic capacity, or because of scour or degradation.

Where bridge repair or rehabilitation is being considered, the cost of the repair should be compared with the cost of complete replacement. The hydraulic requirements of the bridge should also be reviewed when extensive repair or rehabilitation is being contemplated. This hydraulic review is particularly important if a change in the roadway profile is to be included in the rehabilitation.

In some cases, the grade may be raised so that roadway overflow is eliminated without changing the bridge size. This can be a deliberate change of the grade or a slow change, such as maintenance forces placing asphalt overlays on the grade over a period of years. These changes should always be reviewed by the hydraulics design section for effect on flow distribution, on backwater, and on velocity through the bridges.

A replacement bridge may have a deeper superstructure and solid rails. These differences will affect a stream crossing unless compensating adjustments are made in the profile gradeline.

Where the profile grade is raised, the effect may be to eliminate or lessen roadway overflow which could force more water to flow through the bridge opening. Solid rails can have the same effect. If the grade is lowered, the flow pattern and the amount of flow directed over the road and into downstream property could be increased.

When replacement bridges have shorter spans than the existing bridge, the resulting increase in the number of piers could add debris and scour problems or increase backwater.

CULVERT REPLACEMENT

When an existing culvert is to be replaced, an analysis should be made to see if the size of the existing culvert is either smaller or larger than necessary.

CULVERT REHABILITATION

A properly installed culvert generally loses its structural integrity through corrosion and/or abrasion of its invert, although overall loss of material in the pipe wall can occur, some installations due to the corrosive action of the backfill material or the water flowing through the culvert. Common restoration techniques include:

- Provision for replacement of the culvert invert.

- Threading of a smaller size culvert or liner plate through the original culvert and grouting of the voids between the two culverts.

- Use of commercial products for relining pipe with epoxy-coated fabric materials.

Any proposed culvert rehabilitation scheme should be analyzed for hydraulic adequacy and outlet protection. Normally, the smaller cross sectional area resulting from culvert rehabilitation will lead to higher headwater elevation; however, this effect may be insignificant if there is storage upstream or if the potential for damage is minimal. Another consequence of a reduction in pipe size may be higher outlet velocities. This factor should also be assessed during the design of a culvert rehabilitation project.

Use of smooth linings, improved inlets, etc. may also improve the hydraulic performance of the relined culvert and essentially offset the loss of cross sectional area.

Many older culverts were built during a period when less attention was given to the need for accommodating fish passage. Such accommodations can often be incorporated by the addition of baffles in the culvert barrel; however, such designs should be checked to ensure that the revised design is hydraulically adequate.

CULVERT EXTENSIONS

The extension of an existing culvert can result in significant changes to the hydraulic performance. Extending the inlet of a culvert operating in inlet control establishes a higher inlet flow line, which will raise the inlet headwater elevation an equal amount. Extending a culvert which operates under outlet control may also increase the headwater because of head losses associated with the longer barrel.

Culvert extensions can cause the approach or the exit flow alignment to be unacceptable. This can usually be corrected by either extending the culvert on a skew angle that will fit the channel alignment or modifying the channel.

Long culvert extensions could cause the culvert to switch from inlet control to barrel (outlet) control, which will result in an increase in headwater.

In addition to the above noted changes, a long culvert extension may also create problems with fish passage through the culvert that should be addressed during the design.

SIGNING, SIGNALS AND PAVEMENT MARKINGS

Traffic control devices such as signing, signals, and pavement markings must be updated in accordance with the [Manual on Uniform Traffic Control Devices](#) and the VDOT's [Road and Bridge Standards](#).

While traffic control devices cannot fully mitigate all problems associated with substandard geometric features, they are a relatively low cost measure that can compensate for certain operational deficiencies.

Where roadway geometry or other roadway or roadside features are less than standard, do not meet the driver's expectancy, and reconstruction is not feasible, additional signs, markings, delineation and other devices beyond normal requirements of the [MUTCD](#) should be considered.

Judicious use of special traffic regulations, positive guidance techniques, and traffic operational improvements can often forestall expensive reconstruction by minimizing or eliminating adverse safety and operational features on or along existing highways.

Signals are to be provided at warranted locations.

PLAN REVIEWS

Preliminary Plan Reviews and Field Inspections are to be held in accordance with the standard procedures. The Federal Highway Administration (FHWA) is to be notified of each and invited to attend.

PUBLIC INVOLVEMENT

RRR projects are to be developed utilizing the Department's Public Involvement Policy to keep the public sufficiently informed and involved as the project progresses so that a formal public hearing can be eliminated in most, if not all, cases.

RIGHT OF WAY

Although RRR type improvements are normally made within the existing right of way, additional right of way may be required to provide the necessary improvements.

Any required right of way and/or easements will normally be secured by donation. However, right of way may be acquired.

All right of way negotiations are to be conducted in accordance with the applicable statutes, regulations, policies, and procedures stipulated in the Right of Way and Utilities Division's Manual of Instructions and related memoranda.

UTILITIES (UNDERGROUND AND OVERHEAD)

Where utilities are involved on RRR projects, the Department's General Guidelines for Accommodating Utilities Within Highway Right of way are to be followed.

Relocation or adjustment may be required if the minimum clear zone requirements are not met or if the utility system conflicts with proposed RRR improvements and sufficient right of way is available. For Federally funded RRR projects, an exception request must be made if the project does not meet the minimum clear zone requirements.

In some cases, the utility system on RRR projects may be retained without adjustment or relocation if the accident history does not indicate the existence of a hazard or if the system has demonstrated adequate performance and does not conflict with proposed improvements.

TORT LIABILITY AND GEOMETRIC DESIGN

In recent years highway agency administrations have become increasingly concerned about the growth of tort claims. Such claims allege that highway agencies have committed a legal wrong by improper or negligent highway design, operation, or maintenance that became a cause or partial cause of a highway accident. Claims against highway agencies are part of a nationwide problem of rising liability insurance premiums and increasing costs of tort actions.

Studies indicate that the geometric design features covered in RRR standards are usually not the central focus of tort claims. Pavement features, traffic control devices, and roadside barriers account for the large majority of tort claims.

BACKGROUND ON TORT LIABILITY

Tort is defined as a civil wrong or injury, and a tort action seeks repayment for damages to property and injuries to an individual. If a defendant is found negligent in his actions, or lack of action, he is liable for a tort claim and must compensate the plaintiff. State laws and rulings differ regarding tort claims against a governmental entity. In Virginia, as in most states, the courts or state legislatures have eliminated sovereign immunity (whereby an individual cannot sue the state or its agents for negligence).

Highway agencies are spending substantial sums as a result of tort claims. The costs of handling tort claims include not only the direct costs of judgment awards, settlements, and insurance, but also attorneys' fees and the cost of engineers' and other staff time.

Negligence can be alleged on two grounds particularly relevant to highway agencies:

- Agency (or person) improperly performs its duties (misfeasance).
- Agency (or person) fails to perform its duties (nonfeasance).

RRR IMPROVEMENTS AND TORT CLAIMS

Little is known about how frequently the geometric features addressed by RRR design standards are cited in tort claims against highway agencies. Few states maintain data on tort claims by alleged defect. Further, classifying tort lawsuits is difficult because most involve several defects that differ in importance.

Geometric features (such as cross-sections, alignment, and intersections) usually covered by RRR standards account for a small percentage of total claims filed against highway agencies. Of the cases in which a geometric feature is at issue, horizontal and vertical curves are the most often cited.

Pavement features including edge drops, potholes, surface deterioration and slippery pavements, account for large amounts of the settlement costs.

SUSCEPTIBILITY OF RRR PROJECTS AND STANDARDS TO TORT CLAIMS

The standards selected for RRR projects, the design process followed, and the scope of the improvements may influence the litigation of future tort claims. The issues that might arise in a tort action are:

- Did the project meet the appropriate design standards?
- Are the standards reasonable?
- Was the design process reasonable?
- Did the improvements correct existing dangers?
- Should unimproved roads be judged by standards used for roads that are improved?

The resolution of tort claims alleging an inadequate geometric design is contingent on determining the appropriate set of design standards used to assess negligence.

Determining whether a highway improvement project is sufficiently extensive to qualify as reconstruction can be a key issue in a tort claim because reconstruction projects usually must meet current new construction standards.

Deficient roadside signs or pavement markings and pavement edge-drop problems, which are often the basis of tort claims, can be routinely corrected on RRR projects.

DEFENSE OF A RRR PROJECT DESIGN

Although planning and design activities are exempt from liability in most states, this immunity has been held not to apply to decisions made without prior study or conscious deliberation.

Documentation of the planning process should be part of the state highway agency's defense.

For RRR projects, documentation should demonstrate that safety aspects of the roadway design were properly considered. Reports that identify deficiencies in existing roadways are potentially threatening to the public agency preparing the report if the deficiencies are not addressed. Thus, if any exception to an applicable design standard was granted, documentation should explain the reasons for the exception and show that logic and orderly procedures were followed in obtaining it.

When a highway agency contemplates a design exception for a geometric or roadside feature, it should be prepared to prove why the feature need not meet the same standards as other facets of the roadway design. Often, the best defense in this situation is to demonstrate that the safety cost-effectiveness of further upgrading the feature does not meet any reasonable criteria.

Courts seldom rule that the unavailability of funds is justification for not correcting an alleged defect, but the issue of availability of funds can be part of the defense in relation to the agency's programming procedures.

The following points are important to such a defense:

- The agency is aware of the condition of its facilities
- Deficiencies have been ranked on a logical basis
- Given the existing funding, items are being corrected in the order of priority
- Appropriate warnings or other temporary measures should be used to alert the public that deficiencies have not been corrected. The highway agency can then affirm that it has performed its duties in the best way possible with the available resources.

In order to receive immunity for planning and design activities, a state must thoroughly document the design process in order to defend challenges.

A rational and orderly process must be followed if a plan or design is to be considered immune from claims of negligence. If a feature built during construction was not called for in the plans or was altered from the specifications, it is open to a claim of negligence in a tort action.

RRR NOTES ON PROJECT TITLE SHEET

For applicable projects, the following note shall be placed on the plan [title sheet](#) under the Functional Classification and Traffic Data Block:

NOTE: THESE PLANS WERE DESIGNED IN ACCORDANCE WITH VIRGINIA RRR GUIDELINES.

PREVENTIVE MAINTENANCE (PM) PROJECTS / RRR PROJECTS UTILIZING FEDERAL FUNDING ON NATIONAL HIGHWAY SYSTEM (NHS) ROADWAYS*

On April 28, 2009 VDOT and FHWA signed an Agreement for Maintenance Projects on the National Highway System (NHS) to utilize federal funding to perform maintenance/resurfacing, restoration, and rehabilitation (RRR) type work across the Commonwealth. A number of meetings were held between FHWA and VDOT's Location and Design and Maintenance Divisions to discuss the Scope for these type projects, establish a process for the development of these type projects, and to agree upon the level of involvement/oversight that the FHWA will provide. The FHWA and VDOT recognize the fact that the intent of these projects is to preserve the existing infrastructure and provide additional service life for the roadway and/or bridges through a particular corridor with the appropriate level of Preliminary Engineering expenses and a short design/construction time period. FHWA and VDOT agree that by developing guidelines that will provide clarification, flexibility and structure to the use of maintenance/RRR criteria, it will reduce inefficiencies in preliminary engineering and improve these types of projects across the Commonwealth.

* Rev.7/09

The guardrail for both RRR and Preventive Maintenance (PM) projects shall be reviewed for proper height. In cases where the guardrail height is less than 26 inches, it shall be reset as part of the RRR project. The guardrail in preventive maintenance projects will be reset if the paving operations resulted in a reduction of guardrail height.*

It is agreed that FHWA will be invited to briefing/scoping meetings for all PM and RRR projects on the Interstate. Since many of these projects will not meet the thresholds for "Full Oversight", FHWA will maintain a programmatic review of the process.

It is the intent of this policy is to identify the characteristics and document procedures to be used in the development of projects within each of the following two categories:

Category 1: Preventative maintenance and resurfacing.

Category 2: Heavy maintenance and RRR.

Category 1: Preventative Maintenance and Resurfacing:

The activities must be clearly of a preventative measure as opposed to reacting once a corrective action is required. Projects that address deficiencies in pavement structure or increase capacity of the facility are not considered preventive maintenance. All preventative maintenance projects shall maintain and preserve the current level of safety and accessibility and consider additional low cost safety improvements.

Procedural steps for the development of Category 1 projects:

- Identify high crash locations throughout the proposed corridor and conduct a field review to determine isolated or obvious deficiencies that should be addressed as part of a future project.
- Determine whether additional safety improvements such as upgrading guardrail and end treatments, installation of traffic signs and pavement markings, and edge line rumble strips should be included in the proposed project where they are determined to be a cost effective way to improve safety. In no way shall preventative maintenance type projects adversely impact the safety of the traveled way or its users.

* Rev.7/09

- It is agreed that to maintain program flexibility, and in accordance with 23 U.S.C. 109(q), safety improvements for preventative maintenance projects can be deferred and included in future projects in the Statewide Transportation Improvement Program (STIP). It is expected that safety improvements would be programmed within 2 years of the preventative maintenance project. However, extensions beyond the two years can be made with the approval of FHWA. Roadside hardware upgrades will be implemented in accordance with VDOT's Location and Design Division, Instructional and Informational Memorandum, [IIM-LD-220](#) (or any subsequent revisions to the IIM), which can be accessed at <http://www.virginiadot.org/business/locdes/rd-ii-memoranda-index.asp>.*
- Projects shall have an appropriate environmental document to satisfy the National Environmental Policy Act (NEPA), generally a Programmatic Categorical Exclusion (PCE) prepared by the VDOT District Environmental Unit.

Examples of eligible activities under Category 1:

- Corrosion protection activities (Area wide program)
- Highway sign face cleaning (Area wide program)
- Any corrective, restorative or rehabilitative/reconstruction of highway pavement, which extends the service life of pavement for 5 – 15 years
- Milling and replacement of pavement materials
- Addition of a layer or layers of paving materials. (<2.0")
- Replacing surface treatment materials with plant mix asphalt
- Concrete joint sealing
- Diamond grinding of concrete surface
- Thin concrete overlay
- Crack sealing of mainline asphalt pavement or shoulders
- Applying surface treatments to mainline asphalt pavement or shoulders (example: chip seals, slurry seals, latex/micro-surfacing, thin friction course, etc)
- Thin hot mix asphalt overlay (<2.0")
- Grouting, mud jacking and under sealing
- Retro fitting of dowel bars
- Shoulder pulling and wedging for pavement edge drop-off mitigation

Eligible bridge related activities under Category 1:

- Seal or replace leaking joints, reconstruction of joint areas during joint replacement or elimination of deck joints.
- Deck overlays. (Thin bonded overlays, rigid overlays, and asphalt overlays with waterproof membranes).
- Spot and zone painting/coating of structural steel to include bearings for pre-stressed concrete members.

- Painting/coating of structural steel.
- Cathodic Protection (CP) Systems for Bridge Decks.
- Cathodic Protection Systems for Substructure Elements.
- Cathodic Protection Systems for Superstructure Elements other than decks.
- Electrochemical Chloride Extraction (ECE) Treatment for decks.
- Electrochemical Chloride Extraction Treatment for substructure elements.
- Scour countermeasures installation.
- Removing large debris from channels.
- Retrofit of fracture critical members.
- Retrofit of fatigue prone details. (Methods to increase the fatigue life of fatigue prone details, like using ultrasonic impact treatment on welds at ends of cover plates or connection plates welds not positively connected to flanges.)
- Concrete deck repairs in conjunction with installation of deck overlays, CP systems, or ECE treatment.
- Substructure concrete repairs in conjunction with installation of CP systems, ECE treatment, or galvanic anodes (when there are several sources or experimental basis when only one source). (Includes substructure units with cathodic protection jackets.)
- Application of sealants, coatings, and membranes for surface protection of the concrete.
- Bridge cleaning and/or washing service. (Decks, joints, drains, superstructure and substructure horizontal elements.)
- Place concrete mat along the flow line of steel pipe culverts.

NOTE: When eligible substructure work and/or painting/coating of ends of girders under joint locations are leaking, then it is required to have a contract for the work during the same year or the following year to seal the joints.

Category 2: Heavy Maintenance and RRR:

The purpose for this category project is to restore and rehabilitate the pavement structure to extend the service life of the corridor by 15 to 20 years. Projects will typically involve variable depth milling and pavement build up, minimal changes to the vertical and horizontal alignment, include guardrail and roadside hardware improvements and will stay within the existing right of way. The pavement structure may be removed and replaced in its entirety for up to 50% of the project length. Projects will not provide for additional capacity through the corridor. This work is not considered preventive maintenance because of the improvements to the pavement structure.*

* Rev. 7/09

Procedural steps for the development of Category 2 projects:^{*}

- VDOT will review the proposed project to validate that the scope and purpose meets the intent of a RRR project as outlined in this letter.
- Engineering design and analysis will be done to ascertain locations of existing or potential congestion and safety concerns. This analysis will be conducted with the following in mind:
 - (1) Early in the project development phase, VDOT will analyze the proposed project location to establish the applicable controlling design criteria. Any existing geometric features that are not brought up to current standards but meet the design standard during original construction/reconstruction will be documented by VDOT in the project files and copies sent to FHWA for their concurrence. The documentation will be in accordance with VDOT's Road Design Manual, Section A-4, Guidelines for RRR Projects (or any subsequent revisions to the guidelines).
 - (2) The controlling design criteria for Interstate projects are the design criteria used in the original construction or most recent reconstruction. For example, if a project was constructed in 1964, the standards in place at that time and any design exceptions approved at that time would be the allowable design criteria for the RRR project. This is allowed per AASHTO's A Policy on Design Standards Interstate System.
 - (3) VDOT will provide formal design exceptions only for those instances where an existing geometric feature is made worse. In these instances, VDOT will provide the same level of engineering and documentation and follow the normal steps associated with processing a design exception for FHWA approval. However, every effort will be made to bring these substandard geometric features to existing AASHTO design standards.
- Road Safety Audits will be conducted to identify low cost safety countermeasures such as Rumble Strips and Rumble Stripes, Median Barriers, Safety Edges, Left and Right Turn Lanes at Stop-controlled Intersections, Yellow Change Intervals, Medians and Pedestrian Refuge areas and Walkways and will be included in the proposed project where they are determined to be cost effective by the project manager and agreed to by the project team.
- Projects shall have an appropriate environmental document to satisfy NEPA, generally a Programmatic Categorical Exclusion (PCE) prepared by the VDOT District Environmental Unit.

* Rev. 7/09

SECTION A-5-BICYCLE AND PEDESTRIAN FACILITY GUIDELINES

VDOT POLICY TO IMPROVE BICYCLE AND PEDESTRIAN ACCESS

The Commonwealth Transportation Board (CTB) approved a new policy aimed at providing bicyclists and pedestrian's greater access to safe transportation on roadways across the state. The policy became effective upon its adoption by the CTB on March 18, 2004, and will apply to projects that reach the scoping phase after its adoption. This policy shall supersede all current department policies and procedures related to bicycle and pedestrian accommodations.

Highlights from the policy include:

- A framework through which VDOT will accommodate bicyclists and pedestrians, including pedestrians with disabilities, along with motorized transportation modes in the planning, funding, design, construction, operation, and maintenance of Virginia's transportation network to achieve a safe, effective, and balanced multimodal transportation system.
- Sidewalks, bike lanes, shared-use paths or other accommodations will be considered in the design of all new highway and major reconstruction projects, depending on safety issues and the need.

Project Managers should be familiar with the policy prior to starting the Project Development Process. The entire policy can be obtained at http://www.virginiadot.org/programs/resources/bike_ped_policy.pdf

The following are a few excerpts from the policy:

The Virginia Department of Transportation (VDOT) will initiate all highway construction projects with the presumption that the projects shall accommodate bicycling and walking. VDOT will provide the leadership to implement this policy. During the decision process, the project manager and local representatives will, based on the factors listed in the policy, develop a recommendation on how and whether to accommodate bicyclists and pedestrians in a construction project prior to the public hearing. VDOT will promote the inclusion of bicycle and pedestrian accommodations in transportation planning activities at local, regional, and statewide levels. There are exceptions to the provision of accommodations.

Bicycle and pedestrian accommodations can be developed through projects that are independent of highway construction either within the highway right-of-way or on an independent right-of-way. Highway construction funds can be used to build bicycle and pedestrian accommodations either concurrently with highway construction projects or as independent transportation projects. Both types of bicycle and pedestrian accommodation projects will be funded in the same manner as other highway construction projects for each system (i.e., interstate, primary, secondary, or urban).

VDOT will work with localities to select and design accommodations, taking into consideration community needs, safety, and unique environmental and aesthetic characteristics as they relate to specific projects. The selection of the specific accommodations to be included in a project shall be based on the application of appropriate planning design, and engineering principles. Bicycle and Pedestrians accommodations shall be designed and built, or installed, using the VDOT *Road Design Manual*, VDOT *Roads and Bridge Standards and Specifications*, the AASHTO *Guide for the Development of Bicycle facilities*, AASHTO *Guide for the Planning Design and Operation of Pedestrian Facilities*, the *Proposed Accessibility Guidelines for Pedestrian Facilities in the Public Rights-of-Way* and the *Manual on Uniform Traffic Control Devices (MUTCD)*. On August 20, 2013 FHWA issued a *Memorandum* expressing support for taking a flexible approach to bicycle and pedestrian facility design. In doing so, FHWA supports the use of the *NACTO Urban Bikeway Design Guide* and the *ITE Designing Urban Walkable Thoroughfares: A context Sensitive Approach* to build upon the flexibilities provided in the AASHTO guides, which can help communities plan and design safe and convenient facilities for pedestrians and bicyclists. On July 25, 2014, FHWA's Offices of Planning, Environment, and Realty; Infrastructure; Safety; and Operations jointly issued a *Memorandum* announcing their official support and endorsement of *NACTO Urban Street Design Guide*. In May 2015, FHWA released the *Separated Bike Lane Planning and Design Guide*, which outlines planning considerations for separated bike lanes (also sometimes called "cycle tracks" or "protected bike lanes") and provides a menu of design options covering typical one and two-way scenarios. The guide consolidates lessons learned from practitioners designing and implementing separated bike lanes throughout the U.S.*

During the preparations of an environmental impact statement (EIS), VDOT will consider the current and anticipated future use of the affected facilities by bicyclists and pedestrians, the potential impacts of the alternatives on bicycle and pedestrian travel, and proposed measures, if any, to avoid or reduce adverse impacts to the use of these facilities by bicyclists and pedestrians.

During project design VDOT will coordinate with the Virginia Department of Rail and Public Transportation (VDRPT) to address bicyclist and pedestrian access to existing and planned transit connections.

VDOT will ensure that accommodations for bicycling and walking are built in accordance with design plans and VDOT's construction standards and specifications.

* Rev. 7/15

PLANNING AND DESIGN OF BICYCLE FACILITIES

Discussion will take place at the scoping meeting concerning the expected type of bicyclist that will use the facility and the type of facility to be designed. The District, Transportation and Mobility Planning Division, Locality and other interested parties will provide input on the inclusion of a bikeway on a particular project. * Types of bicyclist include Group A, advanced; Group B, basic; and Group C, children. AASHTO designates bicycle facility types as Shared Roadway (No Bikeway Designation), Signed Shared Roadway, Bike Lane or Bicycle Lane and Shared- Use Path.

Individuals involved in the planning and design of bicycle facilities should be familiar with the resources mentioned in the previous section titled: “**VDOT POLICY to improve bicycle and pedestrian access**”.

In rural and some urban sections of highway with scattered development, it is recommended that the facility be designed for Group A bicyclists. In developed areas near parks, schools, recreation areas, etc., it is recommended that the facility be designed for Group B, C bicyclists. Shared-Use Paths are recommended in areas where bicyclists are expected to be children, pre-teen or casual recreation riders.

Guidelines in SELECTING ROADWAY DESIGN TREATMENTS TO ACCOMMODATE BICYCLES are recommended as bicycle facility design criteria, but in no case will a bicycle facility be designed with criteria less than those contained in the VDOT/AASHTO DESIGN GUIDELINES. When a bicycle facility is proposed on a project one set of pertinent plans, profiles and typical sections are to be provided to the Location and Design Bicycle/Pedestrian Facilities Coordinator prior to Preliminary Engineering, Field Inspection and after related comments are received at public information meetings.

The procedure for planning and designing a bicycle facility is:

1. Select the type of bicyclist; A, B or C or a combination of these.
2. Select the roadway design treatment or type of facility.
3. Design the facility in accordance with the resources mentioned in the previous section titled “**VDOT POLICY TO IMPROVE BICYCLE AND PEDESTRIAN ACCESS**”.

BICYCLE ACCESS FACILITIES

VDOT may participate in the development of bicycle access facilities to serve public recreational areas and historic sites based on the current Recreational Access Fund Policy.

* Rev. 7/14

EXISTING ROADS

In some instances, for route continuity, bicycle facilities may be routed over existing facilities which are not planned for expansion. In these cases, the facilities are an operational feature and usually result in the identification of a bike lane, restriction of parking, or some other physical modification to accommodate bicycle travel. It is necessary for the State Transportation and Mobility Planning Administrator to coordinate with the District **Engineer/Administrator**, the Regional Traffic Engineer, and appropriate Divisions in the Central Office to assure agreement on the method of treatment for a bikeway over an existing route. All the conditions of VDOT Bicycle Facility Participation Guidelines and VDOT Funding Guidelines need to be met except the bicycle facility is not required to be constructed concurrently with a highway construction project. VDOT's financial participation and funding will be the same as specified in VDOT Funding Guidelines.

MAJOR DEVELOPMENTS AND SITE PLANS

When bicycle facilities are considered as part of the total development of a property where the road system will be maintained in the future by VDOT and the local government requires bicycle facilities in new developments, the following conditions must be satisfied:

- The bicycle element of the entire plan for the development must be reviewed and approved by the local government prior to final approval by the State Transportation and Mobility Planning Administrator. Appropriate review must be made, and communication regarding the resolution of bicycle facility systems must be carried on between the Transportation Land-Use Director, Regional Traffic Engineer, and the State Transportation and Mobility Planning Administrator.
- Along any roadways identified in the site plan, which will be maintained in the future by VDOT, a bicycle facility may be incorporated into the development parallel to but off of the right of way dedicated for street purposes. The maintenance and the responsibility for operating the bicycle facility would fall on the owner, which would be the locality, the developer, or other entity with the responsibility of maintenance of the common land of the development and not the responsibility of VDOT. The bicycle facility right of way will be exclusive of the roadway right of way; thus, future changes and/or modifications in the bicycle facility would not be the responsibility of VDOT.
- Bicycle facilities within the VDOT right of way shall be designed in accordance with the resources mentioned in the previous section titled: **“VDOT POLICY TO IMPROVE BICYCLE AND PEDESTRIAN ACCESS”**.

For major developments and site plans where the roadway system will not be maintained in the future by VDOT, all bicycle facility connections to VDOT maintained facilities shall be subject to review and approval by the District **Engineer/Administrator**.

* Rev. 7/15

SELECTING ROADWAY DESIGN TREATMENTS TO ACCOMMODATE BICYCLES

Choosing the appropriate facility type is important. No one type of bicycle facility or highway design suits every bicyclist. Within any given transportation corridor, bicyclists may be provided with more than one option to meet the travel and access needs of all potential users.

The choice of highway design will affect the level of use, the types of user that can be expected to use any given road and the level of access and mobility that is afforded bicyclists. For example, a four-lane divided highway with 12-foot travel lanes, no shoulder and a 55 mph speed limit will attract only the most confident of riders. The same road with a 5-foot shoulder or bike lane might provide sufficient “comfortable operating space” for many more adult riders, but would still not be comfortable for children or less confident adults. This latter group might only be accommodated through an alternative route using neighborhood streets linked by short sections of a shared-use path. If such an alternative route is provided and the four-lane road has a continuous paved shoulder, most experienced and many casual adult riders will continue to use the shoulder for the sake of speed and convenience.

Facilities for bicyclists should also be planned to provide continuity and consistency for all users. Children using a bicycle facility to get to school should not have to cross a major arterial without some intersection controls, and shoulders and bike lanes should not end abruptly and unannounced at a difficult intersection or busy stretch of highway.

The selection of a bicycle facility type is dependent on many factors, including the ability of the users, specific corridor conditions and facility cost. AASHTO designates bicycle facility types as Shared Roadway (No Bikeway Designation), Signed Shared Roadway, Bike Lane or Bicycle Lane and Shared-Use Path. The following are explanations of when each of these facilities may be appropriate. Design parameters for these four types are discussed later in this publication.

- Shared Roadway (No Bikeway Designation) - Most bicycle travel in the United States now occurs on streets and highways without bikeway designations. In some instances, a community’s existing street system may be fully adequate for efficient bicycle travel and signing and striping for bicycle use may be unnecessary. In other cases, some streets and highways may be unsuitable for bicycle travel at present, and it would be inappropriate to encourage bicycle travel by designating the routes as bikeways. Finally, some routes may not be considered high bicycle demand corridors, and it would be inappropriate to designate them as bikeways regardless of roadway conditions (e.g., minor residential streets).
- Some rural highways are used by touring bicyclists for inner city and recreational travel. In most cases, such routes should only be designated as bikeways where there is a need for enhanced continuity with other bicycle routes. However, the development and maintenance of 4-foot paved shoulders with a 4-inch edge stripe can significantly improve the safety and convenience of bicyclists and motorists along such routes.

- Signed Shared Roadway - Signed-shared roadways are designated by bike route signs, and serve either to provide continuity to other bicycle facilities (usually Bike Lanes) or designate preferred routes through high-demand corridors.
- Bike Lane or Bicycle lane - Bike lanes are established with appropriate pavement markings and signing along streets in corridors where there is significant bicycle demand and where there are distinct needs that can be served by them. The purpose should be to improve conditions for bicyclists on the streets. Bike lanes are intended to delineate the right of way assigned to bicyclists and motorists and to provide for more predictable movements by each. Bike lanes also help to increase the total capacities of highways carrying mixed bicycle and motor vehicle traffic.
- Shared-Use Path - Generally, shared use paths should be used to serve corridors not served by streets and highways or where wide utility or former railroad right-of-way exists, permitting such facilities to be constructed away from the influence of parallel streets. Shared use paths should offer opportunities not provided by the road system. They can provide a recreational opportunity or, in some instances, can serve as direct commute routes if cross flow by motor vehicles and pedestrians is minimized.

The tables in this section contain roadway design treatments and widths to accommodate bicycles found in the Federal Highway Administration Report "Selecting Roadway Design Treatments to Accommodate Bicycles", Publication Number FHWA-RD-92-073 January 1994. The controlling feature in the design of every bicycle facility is its location, whether it is on the roadway or on an independent alignment. The FHWA Report describes five basic types of facilities to accommodate bicyclists. The Shared Lane or Wide Outside Lane types may be appropriate designs for AASHTO's Shared Roadway (No Bikeway Designation) or Signed Shared Roadway types. The shoulder types may be appropriate designs for AASHTO's Shared Roadway (No Bikeway Designation). The Separate Bike Path correlates to AASHTO's Shared Use Path. The following are FHWA definitions of their five types of bicycle facilities:

- Shared Lane - Shared motor vehicle/bicycle use of a "standard" width travel lane.
- Wide Outside Lane (or wide curb lane) - An outside travel lane with a width of at least 14 feet. Also see Table A-5-1 through A-5-6 for design treatments for various traffic operations and design factors.
- Bike Lane - A portion of the roadway designated by striping, signing, and/or pavement markings for preferential or exclusive use of bicycles. On urban projects the bike lane width is the distance from the face of the curb or front edge of gutter pan* to the bike lane stripe. Therefore, the bike lane stripe will lie 4 feet minimum from the front edge of the gutter pan and 5 feet minimum from the face of curb without gutter pan. See Figure A-5-2.

Note: Delineating bike lanes within the limits of a required shoulder area is not permitted.

* Rev. 1/16

- Shoulder - A paved portion of the roadway to the right of the edge stripe on which bicyclists may ride. These areas are not to be marked or signed as 'bike lanes'.
- Separate Bike Path - A facility physically separated from the roadway and intended for bicycle use.

The FHWA publication categorizes bicyclists into three groups. Group A are advanced bicyclists with experience who can operate under most traffic conditions. Group B are basic bicyclists who are casual or new adult and teenage riders with less confidence of their ability to operate in traffic without special provisions for bicycles. Group C, children, are pre-teen riders whose roadway use is initially monitored by parents.

Tables A-5-1 through A-5-6 indicates the appropriate design treatments given various sets of traffic operations and design factors. The design treatments are considered "desirable widths" by the FHWA. There are three basic types of roadway sections for bicycles; urban without parking, urban with parking, and rural. Controlled-access freeways are considered a special case and are not addressed by the tables.

Roadway improvements such as bicycle facilities depend on the roadway's design. Bicycle facilities located on independent alignment depend on many factors, including the performance capabilities of the bicyclist and the bicycle. The following tables do not include any specific recommendations for separate bike facilities and their design standards are addressed under VDOT/AASHTO Design Guidelines for Shared-Use Paths.

| Average Motor Vehicle Operating Speed | Average Annual Daily Traffic (AADT) Volume | | | | | | | | | | | |
|---------------------------------------|--|----------------|---------------------------|----------|-------------------------|----------------|---------------------------|----------|-------------------------|----------------|---------------------------|----------|
| | less than 2,000 | | | | 2,000-10,000 | | | | over 10,000 | | | |
| | Adequate Sight Distance | | Inadequate Sight Distance | | Adequate Sight Distance | | Inadequate Sight Distance | | Adequate Sight Distance | | Inadequate Sight Distance | |
| | | Truck, Bus, Rv | | | | Truck, Bus, Rv | | | | Truck, Bus, Rv | | |
| less than 30 mph | sl 12 | sl 12 | wc 14 | wc 14 | sl 12 | wc 14 | wc 14 | wc 14 | wc 14 | wc 14 | wc 14 | wc 14 |
| 30-40 mph | wc 14 | wc 14 | wc 15 | wc 15 | wc 14 | wc 15 | wc 15 | wc 15 | wc 14 | wc 15 | wc 15 | wc 15 |
| 41-50 mph | wc 15 | wc 15 | wc 15 | wc 15 | wc 15 | wc 15 | sh 6 | sh 6 | wc 15 | wc 15 | sh 6 | sh 6 |
| over 50 mph | sh 6 | sh 6 | sh 6 | sh 6 | sh 6 | sh 6 | sh 6 | sh 6 | sh 6 | sh 6 | sh 6 | sh 6 |

TABLE A-5-1
GROUP A BICYCLISTS, URBAN SECTION, NO PARKING
 (Widths are in feet)

For Table A-5-1: wc and sl widths represent “usable widths” of outer lanes, measured from lane stripe to edge of gutter pan, rather than to the face of curb. If no gutter pan is provided, add 1 ft. Minimum for shy distance from the face of curb.

Key: wc = wide curb lane; sh = shoulder; sl = shared lane; bl = bike lane; na = not applicable; truck, buses, and/or recreation vehicles (approximately 30 per hour or more)

Source: FHWA’s “Selecting Roadway Design Treatments to Accommodate Bicycles” dated 1994.

| Average Motor Vehicle Operating Speed | Average Annual Daily Traffic (AADT) Volume | | | | | | | | | | | | |
|---------------------------------------|--|----------------|---------------------------|----------|-------------------------|----------------|---------------------------|----------|-------------------------|----------------|---------------------------|----------|----------|
| | less than 2,000 | | | | 2,000-10,000 | | | | over 10,000 | | | | |
| | Adequate Sight Distance | | Inadequate Sight Distance | | Adequate Sight Distance | | Inadequate Sight Distance | | Adequate Sight Distance | | Inadequate Sight Distance | | |
| | | Truck, Bus, Rv | | | | Truck, Bus, Rv | | | | Truck, Bus, Rv | | | |
| less than 30 mph | wc 14 | wc 14 | wc 14 | wc 14 | wc 14 | wc 14 | wc 14 | wc 14 | wc 14 | wc 14 | wc 15 | wc 15 | wc 14 |
| 30-40 mph | wc 14 | wc 14 | wc 15 | wc 15 | wc 14 | wc 15 | wc 15 | wc 15 | wc 14 | wc 15 | wc 15 | wc 15 | wc 15 |
| 41-50 mph | wc 15 | wc 15 | wc 15 | wc 15 | wc 15 | wc 16 | wc 16 | wc 16 | wc 15 | wc 15 | wc 16 | wc 16 | wc 16 |
| over 50 mph | na | na | na | na | na | na | na | na | na | na | na | na | na |

TABLE A-5-2
GROUP A BICYCLISTS, URBAN SECTION, WITH PARKING
 (Widths are in feet)

For Table A-5-2: wc widths represent “usable widths” of outer travel lanes, measured from the left edge of the parking space (8 to 10 ft. minimum from the curb face) to the left stripe of the travel lane.

Key: wc = wide curb lane; sh = shoulder; sl = shared lane; bl = bike lane; na = not applicable; truck, buses, and/or recreation vehicles (approximately 30 per hour or more)

Source: FHWA’s “Selecting Roadway Design Treatments to Accommodate Bicycles” dated 1994.

| Average Motor Vehicle Operating Speed | Average Annual Daily Traffic (AADT) Volume | | | | | | | | | | | |
|---------------------------------------|--|----------------|---------------------------|----------|-------------------------|----------------|---------------------------|----------|-------------------------|----------------|---------------------------|---------|
| | less than 2,000 | | | | 2,000-10,000 | | | | over 10,000 | | | |
| | Adequate Sight Distance | | Inadequate Sight Distance | | Adequate Sight Distance | | Inadequate Sight Distance | | Adequate Sight Distance | | Inadequate Sight Distance | |
| | | Truck, Bus, Rv | | | | Truck, Bus, Rv | | | | Truck, Bus, Rv | | |
| less than 30 mph | sl 12 | sl 12 | wc 14 | wc 14 | sl 12 | wc 14 | wc 14 | wc 14 | wc 14 | wc 14 | sh 4 | sh 4 |
| 30-40 mph | wc 14 | wc 14 | sh 4 | sh 4 | wc 14 | wc 15 | sh 4 | sh 4 | sh 4 | sh 4 | sh 4 | sh 4 |
| 41-50 mph | sh 4 | sh 4 | sh 4 | sh 4 | sh 6 | sh 6 | sh 6 | sh 6 | sh 6 | sh 6 | sh 6 | sh 6 |
| over 50 mph | sh 4 | sh 6 | sh 6 | sh 4 | sh 6 | sh 6 | sh 6 | sh 6 | sh 6 | sh 6 | sh 6 | sh 6 |

TABLE A-5-3
GROUP A BICYCLISTS, RURAL SECTION
 (Widths are in feet)

For Table A-5-3: wc and sl widths represent “usable widths” of outer lanes, measured from lane stripe to edge of the pavement if a smooth, firm, level shoulder is adjacent. If rough or dropped pavement edges or a soft shoulder exists, add 1 ft. minimum for shy distance from the edge of the pavement.

Key: wc = wide curb lane; sh = shoulder; sl = shared lane; bl = bike lane; na = not applicable; truck, buses, and/or recreation vehicles (approximately 30 per hour or more)

Source: FHWA’s “Selecting Roadway Design Treatments to Accommodate Bicycles” dated 1994.

| Average Motor Vehicle Operating Speed | Average Annual Daily Traffic (AADT) Volume | | | | | | | | | | | | |
|---------------------------------------|--|----------------|---------------------------|----------|-------------------------|----------------|---------------------------|----------|-------------------------|----------------|---------------------------|---------|---------|
| | less than 2,000 | | | | 2,000-10,000 | | | | over 10,000 | | | | |
| | Adequate Sight Distance | | Inadequate Sight Distance | | Adequate Sight Distance | | Inadequate Sight Distance | | Adequate Sight Distance | | Inadequate Sight Distance | | |
| | | Truck, Bus, Rv | | | | Truck, Bus, Rv | | | | Truck, Bus, Rv | | | |
| less than 30 mph | wc 14 | wc 14 | wc 14 | wc 14 | wc 14 | wc 14 | wc 14 | wc 14 | wc 14 | bl 5 | bl 5 | bl 5 | bl 5 |
| 30-40 mph | bl 5 | bl 5 | bl 5 | bl 5 | bl 5 | bl 6 | bl 6 | bl 5 | bl 5 | bl 6 | bl 6 | bl 6 | bl 5 |
| 41-50 mph | bl 5 | bl 5 | bl 5 | bl 5 | bl 6 | bl 6 | bl 6 | bl 6 | bl 6 | bl 6 | bl 6 | bl 6 | bl 6 |
| over 50 mph | bl 6 | bl 6 | bl 6 | bl 6 | bl 6 | bl 6 | bl 6 | bl 6 | bl 6 | bl 6 | bl 6 | bl 6 | bl 6 |

TABLE A-5-4
GROUP B/C BICYCLISTS, URBAN SECTION, NO PARKING
 (Widths are in feet)

For Table A-5-4: wc widths represent “usable widths” of outer lanes, measured from lane stripe to edge of gutter pan, rather than to the face of curb. If no gutter pan is provided, add 1 ft. minimum for shy distance from the face of curb. bl widths represent the minimum width from the curb face. For VDOT projects, the bike lane stripe will lie 4 feet minimum from the edge of the gutter pan. The bike lane stripe will lie 5 feet minimum from the face of curb.

Key: wc = wide curb lane; sh = shoulder; sl = shared lane; bl = bike lane; na = not applicable; truck, buses, and/or recreation vehicles (approximately 30 per hour or more)

Source: FHWA’s “Selecting Roadway Design Treatments to Accommodate Bicycles” dated 1994.

| Average Motor Vehicle Operating Speed | Average Annual Daily Traffic (AADT) Volume | | | | | | | | | | | | |
|---------------------------------------|--|----------------|---------------------------|----------|-------------------------|----------------|---------------------------|----------|-------------------------|----------------|---------------------------|---------|---------|
| | less than 2,000 | | | | 2,000-10,000 | | | | over 10,000 | | | | |
| | Adequate Sight Distance | | Inadequate Sight Distance | | Adequate Sight Distance | | Inadequate Sight Distance | | Adequate Sight Distance | | Inadequate Sight Distance | | |
| | | Truck, Bus, Rv | | | | Truck, Bus, Rv | | | | Truck, Bus, Rv | | | |
| less than 30 mph | wc 14 | wc 14 | wc 14 | wc 14 | wc 14 | wc 14 | wc 14 | wc 14 | wc 14 | bl 5 | bl 5 | bl 5 | bl 5 |
| 30-40 mph | bl 5 | bl 5 | bl 5 | bl 5 | bl 5 | bl 6 | bl 6 | bl 5 | bl 6 | bl 6 | bl 6 | bl 6 | bl 6 |
| 41-50 mph | bl 6 | bl 6 | bl 6 | bl 6 | bl 6 | bl 6 | bl 6 | bl 6 | bl 6 | bl 6 | bl 6 | bl 6 | bl 6 |
| over 50 mph | na | na | na | na | na | na | na | na | na | na | na | na | na |

TABLE A-5-5
GROUP B/C BICYCLISTS, URBAN SECTION, WITH PARKING
 (Widths are in feet)

For Table A-5-5: wc and sl widths represent “usable widths” of outer lanes, measured from the left edge of the parking space (8 to 10 ft. minimum from the curb face) to the left stripe of the travel lane.

Key: wc = wide curb lane; sh = shoulder; sl = shared lane; bl = bike lane; na = not applicable; truck, buses and/or recreation vehicles (approximately 30 per hour or more).

Source: FHWA's "Selecting Roadway Design Treatments to Accommodate Bicycles" dated 1994.

| Average Motor Vehicle Operating Speed | Average Annual Daily Traffic (AADT) Volume | | | | | | | | | | | | |
|---------------------------------------|--|----------------|---------------------------|---------|-------------------------|----------------|---------------------------|---------|-------------------------|----------------|---------------------------|---------|---------|
| | less than 2,000 | | | | 2,000-10,000 | | | | over 10,000 | | | | |
| | Adequate Sight Distance | | Inadequate Sight Distance | | Adequate Sight Distance | | Inadequate Sight Distance | | Adequate Sight Distance | | Inadequate Sight Distance | | |
| | | Truck, Bus, Rv | | | | Truck, Bus, Rv | | | | Truck, Bus, Rv | | | |
| less than 30 mph | sh 4 | sh 4 | sh 4 | sh 4 | sh 4 | sh 4 | sh 4 | sh 4 | sh 4 | sh 4 | sh 4 | sh 4 | sh 4 |
| 30-40 mph | sh 4 | sh 4 | sh 4 | sh 4 | sh 4 | sh 6 | sh 6 | sh 4 | sh 6 | sh 6 | sh 6 | sh 6 | sh 6 |
| 41-50 mph | sh 6 | sh 6 | sh 6 | sh 6 | sh 6 | sh 6 | sh 6 | sh 6 | sh 6 | sh 6 | sh 6 | sh 6 | sh 6 |
| over 50 mph | sh 6 | sh 6 | sh 6 | sh 6 | sh 8 | sh 8 | sh 8 | sh 8 | sh 8 | sh 8 | sh 8 | sh 8 | sh 8 |

TABLE A-5-6
GROUP B/C BICYCLISTS, RURAL SECTION
(Widths are in feet)

Key: sh = shoulder;

Source: FHWA's "Selecting Roadway Design Treatments to Accommodate Bicycles" dated 1994.

VDOT/AASHTO DESIGN GUIDELINES

The following design guidelines are to be used in the design of bicycle facilities and have been obtained from AASHTO's 2012 "Guide for the Development of Bicycle Facilities" and in combination with VDOT Policy. Only key information from AASHTO's Guide is contained in this VDOT publication. Individuals involved in the planning and design of bicycle facilities should be familiar with and refer to the latest AASHTO Guide for additional information. AASHTO criteria will be considered as "minimum criteria" by designers. These design guidelines consider four types of bicycle facilities: Shared Roadway (No Bikeway Designation), Signed Shared Roadway, Bike Lane or Bicycle Lane and Shared-Use Path.

When bicycle facilities are proposed, the roadway conditions will be examined for potential problems specific to bicyclists.

Deleted Information*

* Rev. 1/15

SHARED ROADWAYS

The most critical variable affecting the ability of a roadway to accommodate bicycle traffic is width. Adequate width may be achieved by providing paved shoulders or wide outside lanes.

- Paved Shoulders

Paved shoulders should be at least 4 feet wide to accommodate bicycle travel. However, where 4 foot **minimum*** widths cannot be provided, any additional shoulder width is better than none at all. A shoulder width of 5 feet is **required** from the face of guardrail, curb or other roadside barriers. It is desirable to increase the width of shoulders where higher bicycle usage is expected. Additional shoulder width is also desirable if motor vehicle speeds exceed 50 mph, or the percentage of trucks, buses, and recreational vehicles is high, or if lateral obstructions exist at the right side of the roadway. Paved shoulders are not to be marked or signed as “bike lanes”.

On rural and urban collector and local roads and streets, provide minimum **5** foot wide paved shoulders when:

- a) Design Year ADT > 2000 VPD, with \geq 5% total truck and bus usage
or
- b) The route is an AASHTO Approved **U.S.** Bicycle Route or designated as a bicycle route on a Locality’s Thoroughfare Plan and the graded shoulder width is 6 feet or greater.

For the above situations, the remainder of the shoulder will be topsoil and seeded.

AASHTO’s recommendations for shoulder width (as described in *A Policy on Geometric Design of Highways and Streets*) are the best guide for bicycles as well, since wider shoulders are recommended on heavily traveled and high-speed roads and those carrying large numbers of trucks. In order to be usable by bicyclists, the shoulder must be paved.

Rumble strips or raised pavement markers, where installed to discourage or warn motorists they are driving on the shoulder, are not recommended where shoulders are used by bicyclists unless there is a minimum clear path of 1 foot from the rumble strip to the traveled way, 4 feet from the rumble strip to the outside edge of paved shoulder, or 5 feet to adjacent guardrail, curb or other obstacle. If existing conditions preclude achieving the minimum desirable clearance, the width of the rumble strip may be decreased or other appropriate alternative solutions should be considered. VDOT’s policy is to not install pavement markers along the outside edge line of a travelway.

* Rev. 7/12

- Wide Outside Lanes

Wide outside lanes for bicycle use are usually preferred where shoulders are not provided, such as in restrictive urban areas. On highway sections without designated bikeways, an outside or curb lane wider than 12 feet can better accommodate both bicycles and motor vehicles in the same lane and thus is beneficial to both bicyclists and motorists.

In general 14 feet of usable lane width is the recommended width for shared use in a wide outside lane. Usable width normally would be from edge stripe to lane stripe or from the longitudinal joint of the gutter pan to lane stripe (the gutter pan should not be included as usable width). On stretches of roadway with steep grades where bicyclists need more maneuvering space, the wide outside lane should be slightly wider where practicable (15 feet is preferred). The 15 foot width may also be necessary in areas where drainage grates, raised reflectors on the right-hand side of the road, or on-street parking effectively reduce the usable width. With these exceptions in mind, widths greater than 14 feet that extend continuously along a stretch of roadway may encourage the undesirable operation of two motor vehicles in one lane, especially in urban areas, and therefore are not recommended. In situations where more than 15 feet of pavement width exists, consideration should be given to striping bike lanes or shoulders.

- On-Street Parking

When there is on-street parking on urban roadways, the bicycle riding location is in the area between parked cars and moving motor vehicles. 12 feet of combined bicycle travel and parking width should be the minimum considered for this type of shared use. Striping should be provided to delineate the parking stalls (See Figure A-5-1 Section 1).

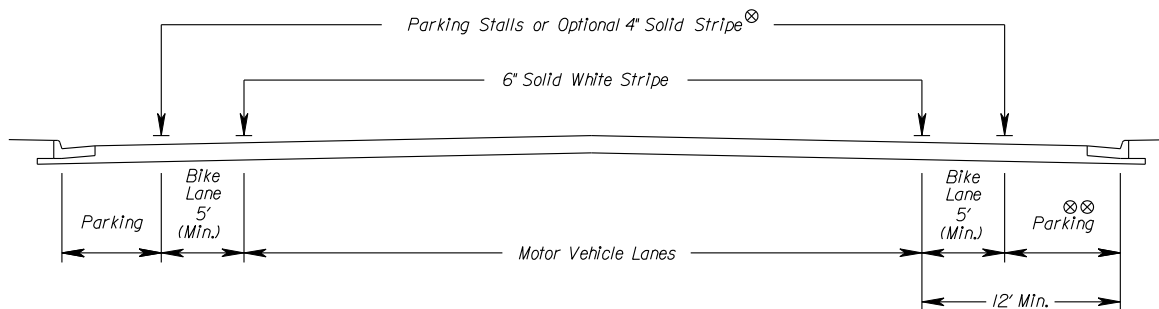
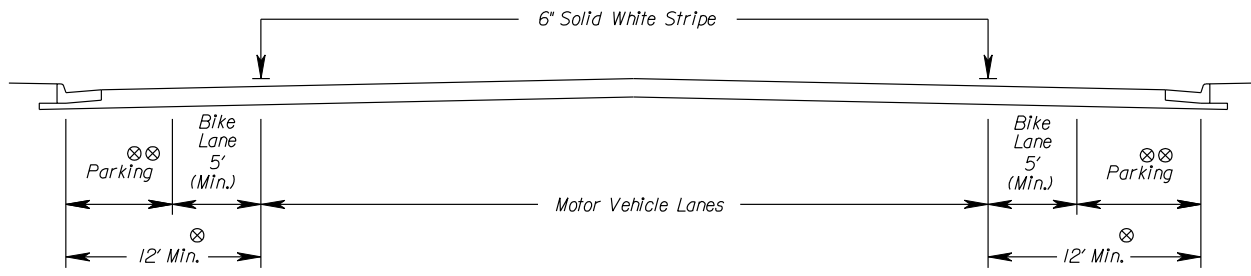

FIGURE A-5-1
(1) BIKE LANES WITH ON-STREET PARKING

⊗The optional solid white stripe may be advisable where stalls are unnecessary (because parking is light) but there is concern that motorists may misconstrue the bike lane to be a traffic lane.

⊗⊗ 7' for Residential Street and 8' Commercial and mix use.*



- ⊗ 13 feet is recommended where there is substantial parking or turnover of parked cars is high (e.g. commercial areas).
- ⊗⊗ 7 feet for Residential Streets and 8 feet for Commercial and mix use Streets.

FIGURE A-5-1
(2) PARKING PERMITTED WITHOUT PARKING STRIPE OR STALL
 (Bike lane not designated or marked)

SIGNED SHARED ROADWAYS

The distinction between shared roadways and signed shared roadways is that signed are those that have been identified by signing as preferred bike routes.

BIKE LANES

Bike lanes are incorporated into a roadway design when it is desirable to delineate available road space for use by bicyclists and motorists. Delineating bike lanes within the limits of a required paved shoulder area is not permitted. Urban settings will typically use a bike lane to accommodate bicyclists (See Figure A-5-2, (1)). Rural areas will normally make use of a 4' minimum paved shoulder to accommodate bicyclists (See Figure A-5-2, (2)).

Bike lanes should be one-way facilities and carry bike traffic in the same direction as adjacent motor vehicle traffic. Two-way bike lanes on one side of the roadway are not recommended when they result in bicycle riding against the flow of motor vehicle traffic. In general, on one-way streets, a bike lane should be placed only on the right side of the street.

Deleted Information*

* Rev. 1/15

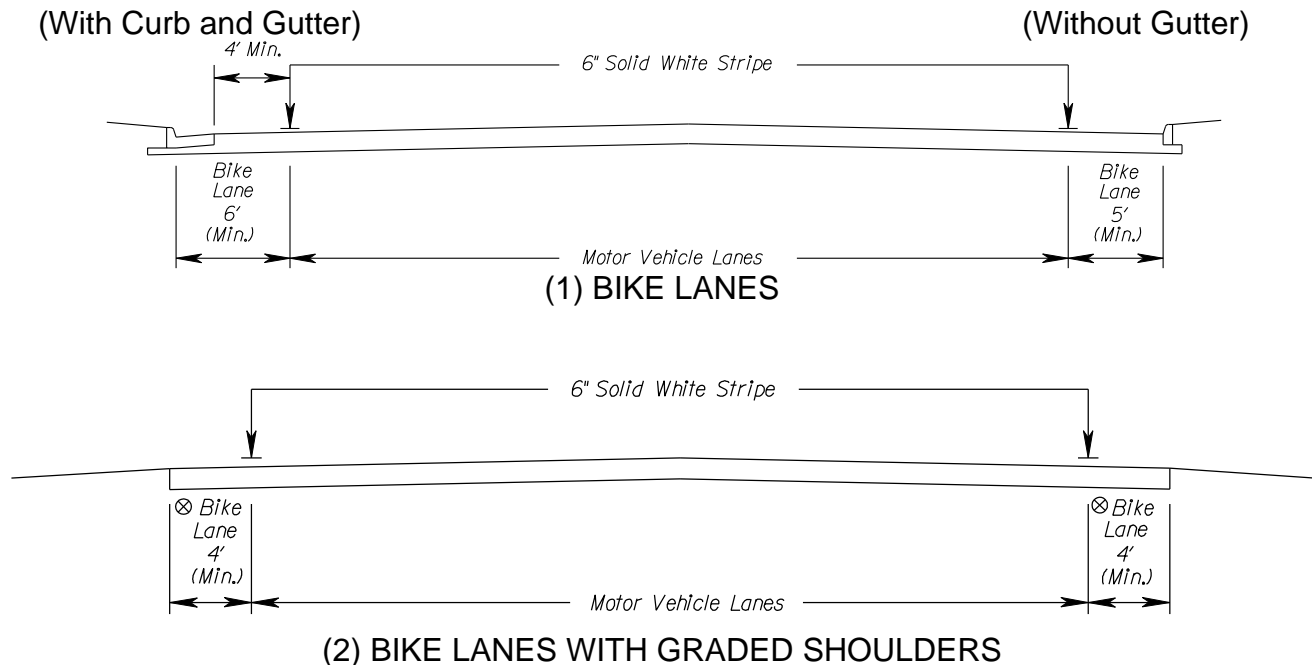

⊗ Delineating bike lanes within the limits of a required paved shoulder area is not permitted*.

FIGURE A-5-2
TYPICAL BIKE LANE CROSS SECTIONS

- Bike Lane Widths

The width of a bike lane is 5 feet minimum from the face of a curb to the bike lane stripe on roadways without a gutter pan. The width of a bike lane is 4 feet minimum from the edge of pavement (face of gutter pan) to the bike lane stripe on curb and gutter roadways. Greater bike lane widths are desirable where substantial truck traffic is present, or where motor vehicle speeds exceed 50 mph. Where vehicle traffic volume is high or substantial truck, bus or recreational vehicle traffic is present or speeds warrant, 6 feet minimum is appropriate to the bike lane stripe from the face of curb. Figure A-5-2, Section (1), depicts a bike lane along the outer portion of an urban curbed street where parking is prohibited.

Bicyclists tend to ride a distance of 32 to 40 inches from a curb face and it is important that the surface in this area be smooth and free of structures. Drain inlets and utility covers that extend into this area may cause bicyclists to swerve, and have the effect of reducing the usable width of the lane. Where these structures exist, the bike lane width may need to be adjusted accordingly.

If parking is permitted, as in Figure A-5-1, Section (1), the bike lane shall be placed between the parking area and the travel lane and have a minimum width of 5 feet. Bike lanes should never be placed between the parking lane and curb line.

- Bike Lanes and Turning Lanes

Bike lanes complicate bicycle and motor vehicle turning movements at intersections. It is preferable to continue the same width of bike lane through the intersection. For example,* locations where a bike lane approaches an intersection (4 feet from the edge of pavement on a curb and gutter roadway), the bike lane should continue parallel to the left of a right turn lane. See Figure A-5-3 below.

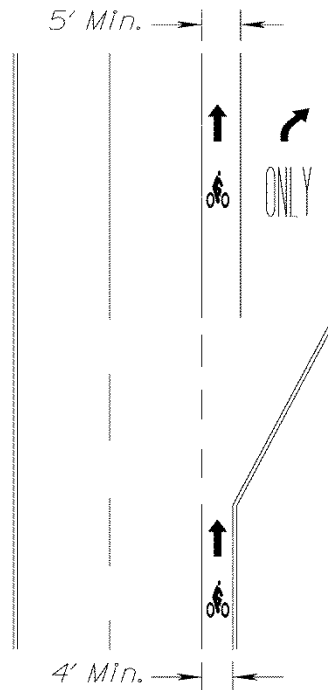

FIGURE A-5-3
RIGHT TURN ONLY LANE

- Bicycle Lanes Approaching Right-Turn-Only Lanes

NOTES: For other intersection situations see the AASHTO Guide for the Development of Bicycle Facilities. For current typical bicycle lane pavement markings see VDOT [Road and Bridge Standards](#) or current insertable sheets.

Figure A-5-3 presents a treatment for pavement markings where a bike lane approaches a motorist right-turn-only lane. The design of bike lanes should include appropriate signing at intersections to warn of conflicts. The approach shoulder width should be provided through the intersection, where feasible, to accommodate right turning bicyclists or bicyclists who prefer to use crosswalks to negotiate the intersection.

* Rev. 7/15

SHARED USE PATHS

Shared use paths are facilities physically separated from motorized vehicular traffic by an open space (buffer) or barrier and either within the highway right of way or within an independent right of way. Users are non-motorized and may include bicyclists, inline skaters, roller skaters, wheelchair users (both non-motorized and motorized) and pedestrians including walkers, runners, and people with baby strollers and people walking dogs. Shared use paths are most commonly designed for two-way travel, and the following guidance assumes a two-way facility is planned unless otherwise stated. When paths are planned, it is desirable to provide paths on both sides of the roadway to decrease the likelihood of children crossing the road. Pavement design for shared use paths are recommended by the Materials Division.

Care should be taken not to use shared use path and trail interchangeably because they have distinctly different design guidelines.

- Separation Between Shared Use Paths and Roadways

Shoulder and Ditch Typical Section:

When two directional shared use paths are located adjacent to a roadway, wide separation between a shared use path and the adjacent highway is desirable to demonstrate to both the bicyclist and the motorist that the path functions as an independent facility for bicyclists and others. On shoulder and ditch typical sections shared use paths should be placed behind the ditch in a manner that will be compatible with the roadway if the roadway is converted to a curb and/or curb and gutter typical section. When this is not possible and the distance between the outside edge of the graded shoulder and the shared use path is less than 5 feet, a suitable physical barrier is required.* A suitable physical barrier is defined as dense shrubbery, railing or chain link fence. Such barriers serve both to prevent path users from making unwanted movements between the path and the highway shoulder and to reinforce the concept that the path is an independent facility. Where used, the barrier should be a minimum of 42 inches high (54 inches on structures), to prevent bicyclists from toppling over it. A barrier between a shared use path and adjacent highway should not impair sight distance at intersections, and should be designed to not be a hazard to motorists or bicyclist.

Curb and/or Curb and Gutter Typical Sections:

For curb and/or curb and gutter streets, the separation between from face of the curb to the edge of the shared use path shall be a minimum of 8 feet in order to meet the minimum lateral offset distance to install signs for the roadway and the shared use path in accordance with MUTCD Part 2 and part 9. If signs are required on the outside of the shared use path due to horizontal and vertical grade changes then a minimum of 6.5' of right of way from the edge of the path shall be provided. If signs are not required, a minimum 3' of right of way shall be provided. See Figure A-5-4.

* Rev. 7/13

- Separation between Shared Use Paths and Equestrian Trail

Horses can be startled easily and may act unpredictably if they perceive approaching bicyclists as a danger. Measures to mitigate bicyclist-equestrian conflicts include provision of separate bridle paths, maintenance of adequate sight lines so that bicycles and equestrians are able to see each other well in advance, and signing that clarifies appropriate passing techniques and yielding responsibilities. Along paths with high to moderate use, the separate paved and unpaved tread should be divided by at least a 6 ft. wide vegetation buffer or barrier.*

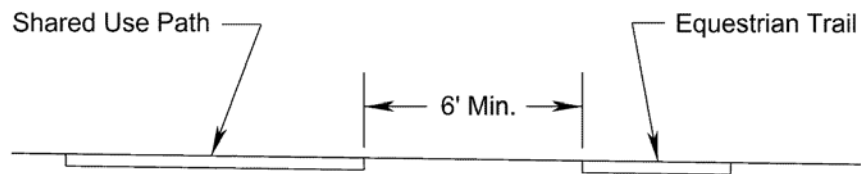

Source: AASHTO, *Guide for the Development of Bicycle Facilities*, 2012

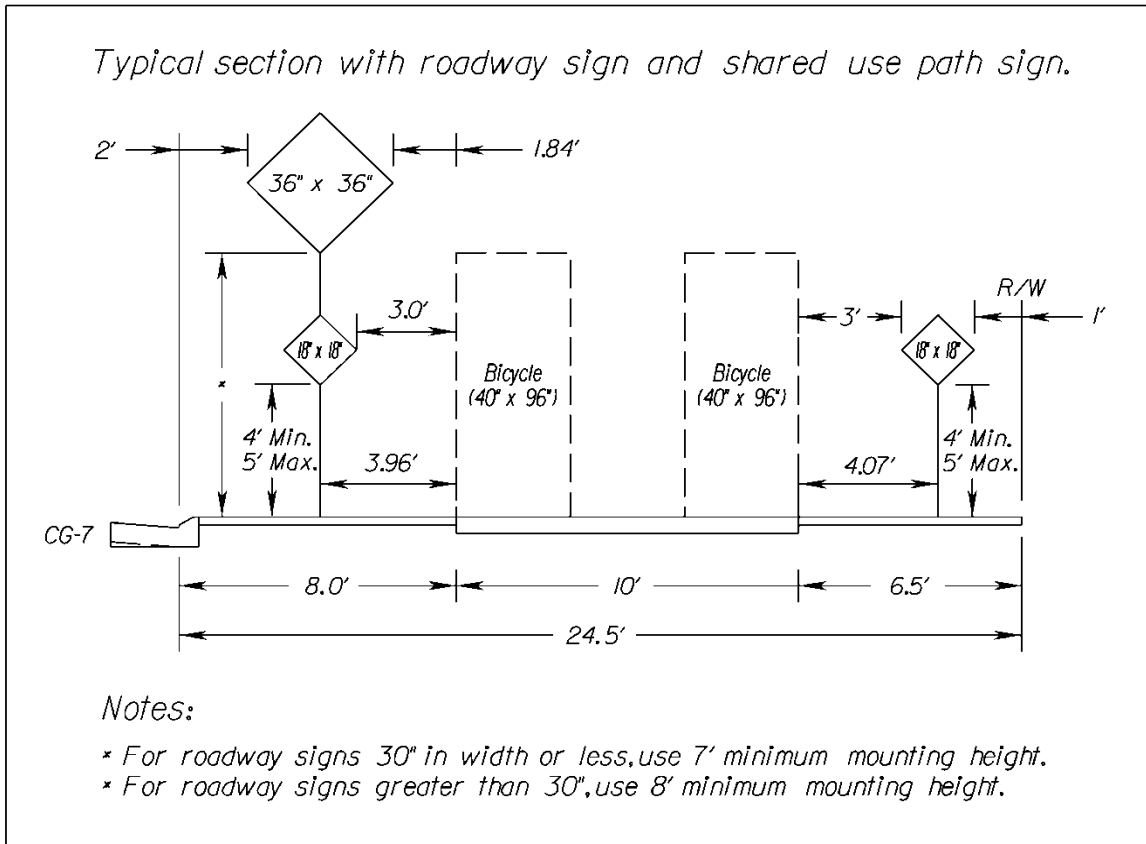

FIGURE A-5-4
SHARED USE PATHS

- Width and Horizontal Clearance

The paved width and the operating width required for a shared use path are primary design considerations. The minimum paved width for a two-directional shared use path is 10 feet. See Figure A-5-5. However in rare instances, a reduced width of 8 feet may be used. This reduced width may be used only where the following conditions prevail:

- (1) Bicycle traffic is expected to be low, even on peak days or during peak hours.
- (2) Pedestrian use of the facility is not expected to be more than occasional.
- (3) There will be good horizontal and vertical alignment providing safe and frequent passing opportunities, and
- (4) During normal maintenance activities the path will not be subjected to maintenance vehicle loading conditions that would cause pavement edge damage.

Under certain conditions it may be necessary or desirable to increase the width of a shared use path to 11 feet, or even 14 feet, due to substantial use by bicycles, joggers, skaters and pedestrians, use by large maintenance vehicles, and steep grades.

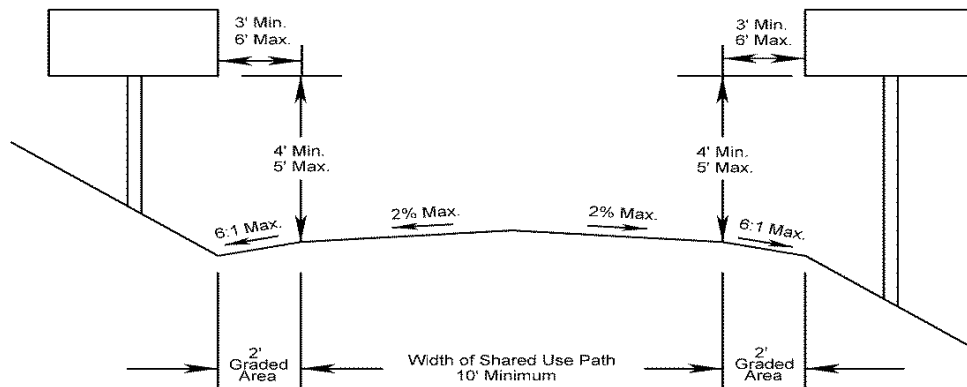

**FIGURE A-5-5
CROSS SECTION OF TWO-WAY SHARED USE PATH***

The minimum width of a one-directional shared use path is 6 feet. A one-way path would rarely be designed and only in a special situation. It should be recognized that one-way paths often would be used as two-way facilities unless effective measures are taken to assure one-way operation. Without such enforcement, it should be assumed that shared use paths would be used as two-way facilities by both pedestrians and bicyclists and designed accordingly.

A minimum 2 foot wide graded area with a maximum 6:1 slope, shall be maintained adjacent to both sides of the path. A minimum 3 foot clearance shall be maintained from the edge of the path to signs, trees, poles, walls, fences, railing, guardrail, or other lateral obstructions. Where the path is adjacent to parallel water hazard, other obvious hazard or downward slope equal to or steeper than 3:1, a minimum 5 foot wide separation from the edge of the path pavement to the top of slope is required. When the separation from the edge of the shared use path to the top of the slope is less than 5 feet, a physical barrier such as railing (HR-1, Type III) or chain link fence is required in the following situations:

- Slopes 2:1 or steeper, with a drop of 4 feet or greater
- Slopes 3:1 or steeper, with a drop of 6 feet or greater
- Slopes 3:1 or steeper, adjacent to a parallel water hazard or other obvious hazard

See FIGURE A-5-6 PHYSICAL BARRIER FOR SHARED-USE PATH

Note: When the separation from the edge of the shared use path to the top of the slope is 5 feet or greater situations may dictate a physical barrier, such as the height of embankment or conditions at the bottom (i.e. – water greater than 2 feet deep).

When a shared use path is constructed adjacent to a retaining wall or a structure with a drop-off 1' or more, a railing or chain link fence 54 inches high is required.

* Rev. 1/14

When physical barrier, railing (HR-1, Type III)* or chain link fence are required. See Road and Bridge Standards for details.

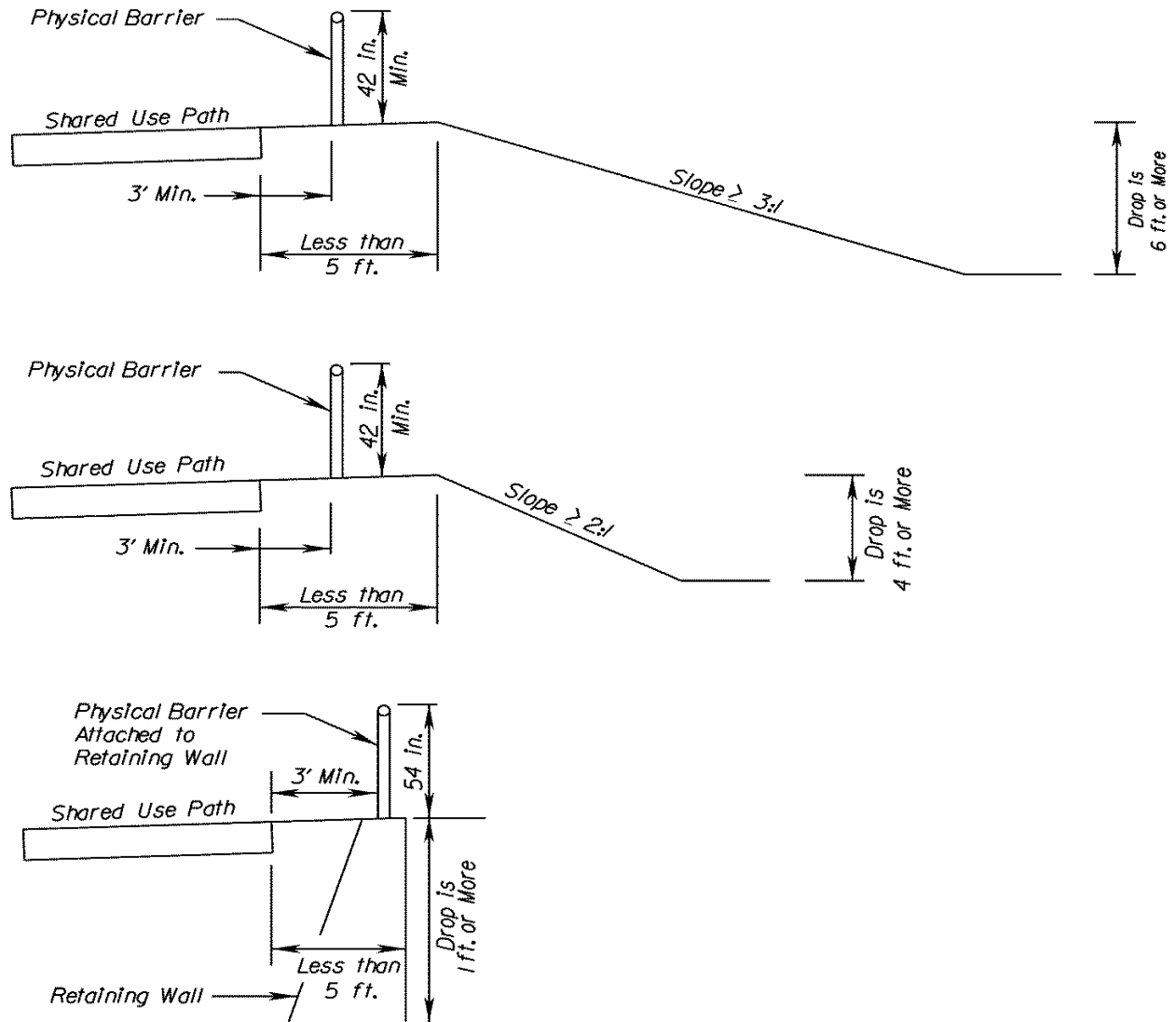

FIGURE A-5-6 PHYSICAL BARRIER FOR SHARED-USE PATH

* Rev. 1/11

The physical barrier, railing HR-1 Type III or chain link fence shall begin prior to, and extend beyond the area of need. The lateral offset of the physical barrier shall be 3 feet from the edge of the shared use path. The ends of the physical barrier shall be flared away from the edge of the shared use path.

When railing or fence is used to discourage shared use path users from venturing off the path or onto adjacent property the design can include two or four horizontal members with vertical members spaced frequently enough to provide the needed structural support and in accordance with applicable building codes. Berms and/or vegetation can also be used to serve this function. The location of the railing or fence in relationship to the shared use path shall be the same as the location of physical barrier mentioned above.

- Vertical Clearance

The vertical clearance from the shared use path to the bottom of any sign or overhanging vegetation (Trees) shall be a minimum of 8 feet in accordance with the MUTCD, Part 9 and AASHTO's *Guide for the Development of Bicycle Facilities*, 2012 respectively. However, vertical clearance may need to be greater to permit passage of maintenance and emergency vehicles. In under crossings and tunnels, 10 feet is desirable for adequate vertical shy distance.

- Design Speed

Shared use paths should be designed for a selected speed that is at least as high as the preferred speed of the faster bicyclists. Design speeds range from 12 mph to 30 mph, as shown in Table A-5-7. However, in general a minimum design speed 18 mph should be used. When a downgrade of 6% or greater exist, or where strong prevailing tailwinds exist, a maximum design speed of 30 mph shall be used.

- Horizontal Alignment

Most shared use paths built in the United States must also meet the requirements of the Americans with Disabilities Act. ADA guidelines require that cross slopes not exceed 2% to avoid the severe difficulties that greater cross slopes can create for people using wheelchairs. Thus, for shared use paths, the maximum superelevation rate will be 2%. When transitioning a 2% superelevation, a minimum 25 foot transition distance should be provided between the end and beginning of consecutive and Reversing horizontal curves.

The coefficient of friction depends upon speed; surface type, roughness, and condition; tire type and condition; and whether the surface is wet or dry. Extrapolating from values used in highway design, design friction factors for paved shared use paths can be assumed to vary from 0.34 at 6 mph to 0.21 at 30 mph.

Based upon various design speeds of 18 to 30 mph and a desirable maximum lean angle of 20°, minimum radii of curvature for Paved Shared Use Paths can be selected from Table A-5-7:

| Design Speed (V) (mph) | Minimum Radius (feet) |
|---------------------------|--------------------------|
| 12 | 27 |
| 14 | 36 |
| 16 | 47 |
| 18 | 60 |
| 20 | 74 |
| 25 | 115 |
| 30 | 166 |

TABLE A-5-7

MINIMUM RADII FOR PAVED SHARED USE PATHS BASED ON 20° LEAN ANGLE

Source: AASHTO – Guide For The Development Of Bicycle Facilities.

- Grade

Grades on shared use paths should be kept to a minimum, especially on long inclines. Grades greater than 5 percent are undesirable because the ascents are difficult for many bicyclists to climb and the descents cause some bicyclists to exceed the speeds at which they are competent or comfortable. The maximum grade of a shared use path adjacent to a roadway should be 5 percent, but the grade shall generally match the grade of the adjacent roadway. Where a shared use path runs adjacent to the roadway, grades may exceed 5 percent but shall be less than or equal to the roadway grade.

Grades on shared use paths in independent rights of way shall be limited to 5 percent maximum.

Grades steeper than 3 percent are not practical for shared use paths with crushed stone or other unpaved surfaces for both bicycle handling and drainage erosion reasons.

Options to mitigate excessive grades on shared use paths include the following:

- Use higher design speeds for horizontal and vertical curvature, stopping sight distance and other geometric features.

- When using longer grades, consider an additional 4 to 6 feet of width to permit slower bicyclists to dismount and walk uphill, and to provide more maneuvering space for fast downhill bicyclists.*
- Install hill warning signs for bicyclists (W7-5) and advisory speed plaque, if appropriate, per the [MUTCD](#).
- Provide signage that alerts path users to the maximum percent of grade as shown in the [MUTCD](#).
- Exceed minimum horizontal clearances, recovery area, and /or install protective railing.
- If other designs are not practicable, use a series of short switchbacks to traverse the grade. If this is done, an extra 4 to 6 feet of path width is recommended to provide maneuvering space.
- Provide resting intervals with flatter grades to permit users to stop periodically and rest.

* Rev. 7/13

- Sight Distance

The following charts indicate the minimum stopping sight distance for various design speeds and grades based on a total perception and brake reaction time of 2.5 seconds and a coefficient of friction of 0.16* to account for the poor wet weather braking characteristics of many bicycles. For two-way shared use paths, the sight distance in the descending direction, that is, where “G” is negative, will control the design.

Sight Distance Descending Grade (ft.)

| | 0% | -1% | -2% | -3% | -4% | -5% |
|--------|-----|-----|-----|-----|-----|-----|
| 12 mph | 74 | 76 | 78 | 80 | 84 | 87 |
| 14 mph | 92 | 95 | 98 | 102 | 106 | 111 |
| 16 mph | 112 | 116 | 120 | 124 | 130 | 136 |
| 18 mph | 133 | 138 | 143 | 149 | 156 | 164 |
| 20 mph | 157 | 162 | 169 | 176 | 185 | 195 |
| 25 mph | 212 | 231 | 241 | 252 | 265 | 281 |
| 30 mph | 298 | 310 | 324 | 341 | 360 | 383 |

TABLE A-5-8 MINIMUM STOPPING SIGHT DISTANCE (FT.) DESCENDING GRADE

Sight Distance Ascending Grade (ft.)

| | 0% | 1% | 2% | 3% | 4% | 5% |
|--------|-----|-----|-----|-----|-----|-----|
| 12 mph | 74 | 72 | 70 | 69 | 68 | 67 |
| 14 mph | 92 | 90 | 88 | 86 | 84 | 82 |
| 16 mph | 121 | 109 | 106 | 104 | 101 | 99 |
| 18 mph | 133 | 130 | 126 | 123 | 120 | 117 |
| 20 mph | 157 | 152 | 147 | 144 | 140 | 137 |
| 25 mph | 212 | 214 | 207 | 201 | 196 | 191 |
| 30 mph | 298 | 287 | 277 | 268 | 260 | 253 |

TABLE A-5-9 MINIMUM STOPPING SIGHT DISTANCE (FT.) ASCENDING GRADE

$$S = \frac{V^2}{30(f \pm G)} + 3.67 V$$

Where: S = stopping sight distance (feet)
 V = velocity (mph)
 F = coefficient of friction (use 0.16)
 G = grade (ft/ft) (rise/run)

Source: AASHTO – *Guide for the Development of Bicycle Facilities.*

* Rev. 1/13

Table A-5-10* indicates the minimum length of vertical curve necessary to provide minimum stopping sight distance at various speeds on crest vertical curves. The eye height of the bicyclist is assumed to be 4.5 feet and the object height is assumed to be 0 inches to recognize that impediments to bicycle travel exist at pavement level.

| A (%) | "S" = Stopping Sight Distance (feet) | | | | | | | | | | | | | | |
|----------|--------------------------------------|----|-----|-----|-----|-----|-----|-----|-----|------|------|------|------|------|------|
| | 20 | 40 | 60 | 80 | 100 | 120 | 140 | 160 | 180 | 200 | 220 | 240 | 260 | 280 | 300 |
| 2 | | | | | | | | | | | | 30 | 70 | 110 | 150 |
| 3 | | | | | | | | 20 | 60 | 100 | 140 | 180 | 220 | 260 | 300 |
| 4 | | | | | | 15 | 55 | 95 | 135 | 175 | 215 | 256 | 300 | 348 | 400 |
| 5 | | | | | 20 | 60 | 100 | 140 | 180 | 222 | 269 | 320 | 376 | 436 | 500 |
| 6 | | | | 10 | 50 | 90 | 130 | 171 | 216 | 267 | 323 | 384 | 451 | 523 | 600 |
| 7 | | | | 31 | 71 | 111 | 152 | 199 | 252 | 311 | 376 | 448 | 526 | 610 | 700 |
| 8 | | | 8 | 48 | 88 | 128 | 174 | 228 | 288 | 356 | 430 | 512 | 601 | 697 | 800 |
| 9 | | | 20 | 60 | 100 | 144 | 196 | 256 | 324 | 400 | 484 | 576 | 676 | 784 | 900 |
| 10 | | | 30 | 70 | 111 | 160 | 218 | 284 | 360 | 444 | 538 | 640 | 751 | 871 | 1000 |
| 11 | | | 38 | 78 | 122 | 176 | 240 | 313 | 396 | 489 | 592 | 704 | 826 | 958 | 1100 |
| 12 | | 5 | 45 | 85 | 133 | 192 | 261 | 341 | 432 | 533 | 645 | 768 | 901 | 1045 | 1200 |
| 13 | | 11 | 51 | 92 | 144 | 208 | 283 | 370 | 468 | 578 | 699 | 832 | 976 | 1132 | 1300 |
| 14 | | 16 | 56 | 100 | 156 | 224 | 305 | 398 | 504 | 622 | 753 | 896 | 1052 | 1220 | 1400 |
| 15 | | 20 | 60 | 107 | 167 | 240 | 327 | 427 | 540 | 667 | 807 | 960 | 1127 | 1307 | 1500 |
| 16 | | 24 | 64 | 114 | 178 | 256 | 348 | 455 | 576 | 711 | 860 | 1024 | 1202 | 1394 | 1600 |
| 17 | | 27 | 68 | 121 | 189 | 272 | 370 | 484 | 612 | 756 | 914 | 1088 | 1277 | 1481 | 1700 |
| 18 | | 30 | 72 | 128 | 200 | 288 | 392 | 512 | 648 | 800 | 968 | 1152 | 1352 | 1568 | 1800 |
| 19 | | 33 | 76 | 135 | 211 | 304 | 414 | 540 | 684 | 844 | 1022 | 1216 | 1427 | 1655 | 1900 |
| 20 | | 35 | 80 | 142 | 222 | 320 | 436 | 569 | 720 | 889 | 1076 | 1280 | 1502 | 1742 | 2000 |
| 21 | | 37 | 84 | 149 | 233 | 336 | 457 | 597 | 756 | 933 | 1129 | 1344 | 1577 | 1829 | 2100 |
| 22 | | 39 | 88 | 156 | 244 | 352 | 479 | 626 | 792 | 978 | 1183 | 1408 | 1652 | 1916 | 2200 |
| 23 | | 41 | 92 | 164 | 256 | 368 | 501 | 654 | 828 | 1022 | 1237 | 1472 | 1728 | 2004 | 2300 |
| 24 | 3 | 43 | 96 | 171 | 267 | 384 | 523 | 683 | 864 | 1067 | 1291 | 1536 | 1803 | 2091 | 2400 |
| 25 | 4 | 44 | 100 | 178 | 278 | 400 | 544 | 711 | 900 | 1111 | 1344 | 1600 | 1878 | 2178 | 2500 |

Source: AASHTO – *Guide for the Development of Bicycle Facilities*.

Heavy line represents S = L

when S > L $L = 2S - \frac{900}{A}$

L = Minimum Length of Vertical Curve (feet)

A = Algebraic Grade Difference (%)

when S < L $L = AS^2/900$

S = Stopping Sight Distance (feet)

Height of cyclist eye – 4.5 feet

Minimum Length of Vertical Curve = 3 feet

Height of object – 0 feet

TABLE A-5-10 – MINIMUM LENGTH OF CREST VERTICAL CURVE (L) BASED ON STOPPING SIGHT DISTANCE

* Rev. 1/13

Figure A-5-8 and Table A-5-11 indicate the minimum clearance that should be used to line of sight obstructions for horizontal curves. The lateral clearance is obtained from the stopping sight distance and the proposed horizontal radius of curvature. The stopping sight distance is obtained from Table A-5-9 and Table A-5-10.

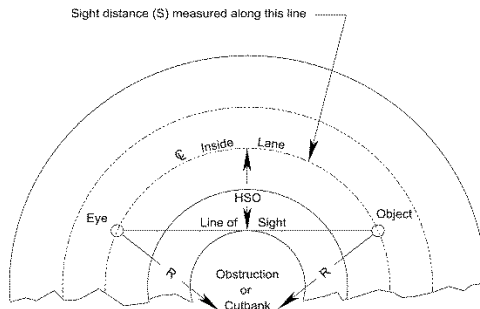

S = Sight distance in feet.
 R = Radius of \mathcal{C} inside lane in feet.
 H = Distance from \mathcal{C} inside lane in feet.
 Angle is expressed in degrees

$$H = R \left[1 - \cos \left(\frac{28.65 S}{R} \right) \right]$$

$$S = \frac{R}{28.65} \left[\cos^{-1} \left(\frac{R - H}{R} \right) \right]$$

Formula applies only when S is equal to or less than length of curve.
 Line of sight is 2.3 feet above centerline of inside lane at point of obstruction.

FIGURE A-5-8*

| R (feet) | "S" = Stopping Sight Distance (feet) | | | | | | | | | | | | | | |
|-------------|--------------------------------------|-----|------|------|------|------|------|------|------|------|------|------|------|------|------|
| | 20 | 40 | 60 | 80 | 100 | 120 | 140 | 160 | 180 | 200 | 220 | 240 | 260 | 280 | 300 |
| 25 | 2.0 | 7.6 | 15.9 | | | | | | | | | | | | |
| 50 | 1.0 | 3.9 | 8.7 | 15.2 | 23.0 | 31.9 | 41.5 | | | | | | | | |
| 75 | 0.7 | 2.7 | 5.9 | 10.4 | 16.1 | 22.8 | 30.4 | 38.8 | 47.8 | 57.4 | 67.2 | | | | |
| 95 | 0.5 | 2.1 | 4.7 | 8.3 | 12.9 | 18.3 | 24.7 | 31.8 | 39.5 | 48.0 | 56.9 | 66.3 | 75.9 | 85.8 | |
| 125 | 0.4 | 1.6 | 3.6 | 6.3 | 9.9 | 14.1 | 19.1 | 24.7 | 31.0 | 37.9 | 45.4 | 53.5 | 61.7 | 70.6 | 79.7 |
| 155 | 0.3 | 1.3 | 2.9 | 5.1 | 8.0 | 11.5 | 15.5 | 20.2 | 25.4 | 31.2 | 37.4 | 44.2 | 51.4 | 59.1 | 67.1 |
| 175 | 0.3 | 1.1 | 2.6 | 4.6 | 7.1 | 10.2 | 13.8 | 18.0 | 22.6 | 27.8 | 33.5 | 39.6 | 46.1 | 53.1 | 60.5 |
| 200 | 0.3 | 1.0 | 2.2 | 4.0 | 6.2 | 8.9 | 12.1 | 15.8 | 19.9 | 24.5 | 29.5 | 34.9 | 40.8 | 47.0 | 53.7 |
| 225 | 0.2 | 0.9 | 2.0 | 3.5 | 5.5 | 8.0 | 10.8 | 14.1 | 17.8 | 21.9 | 26.4 | 31.3 | 36.5 | 42.2 | 48.2 |
| 250 | 0.2 | 0.8 | 1.8 | 3.2 | 5.0 | 7.2 | 9.7 | 12.7 | 16.0 | 19.7 | 23.8 | 28.3 | 33.1 | 38.2 | 43.7 |
| 275 | 0.2 | 0.7 | 1.6 | 2.9 | 4.5 | 6.5 | 8.9 | 11.6 | 14.6 | 18.0 | 21.7 | 25.8 | 30.2 | 34.9 | 39.9 |
| 300 | 0.2 | 0.7 | 1.5 | 2.7 | 4.2 | 6.0 | 8.1 | 10.6 | 13.4 | 16.5 | 19.9 | 23.7 | 27.7 | 32.1 | 36.7 |
| 350 | 0.1 | 0.6 | 1.3 | 2.3 | 3.6 | 5.1 | 7.0 | 9.1 | 11.5 | 14.2 | 17.1 | 20.4 | 23.9 | 27.6 | 31.7 |
| 390 | 0.1 | 0.5 | 1.2 | 2.1 | 3.2 | 4.6 | 6.3 | 8.2 | 10.3 | 12.8 | 15.4 | 18.3 | 21.5 | 24.9 | 28.5 |
| 500 | 0.1 | 0.4 | 0.9 | 1.6 | 2.5 | 3.6 | 4.9 | 6.4 | 8.1 | 10.0 | 12.1 | 14.3 | 16.8 | 19.5 | 22.3 |
| 565 | | 0.4 | 0.8 | 1.4 | 2.2 | 3.2 | 4.3 | 5.7 | 7.2 | 8.8 | 10.7 | 12.7 | 14.9 | 17.3 | 19.8 |
| 600 | | 0.3 | 0.8 | 1.3 | 2.1 | 3.0 | 4.1 | 5.3 | 6.7 | 8.3 | 10.1 | 12.0 | 14.0 | 16.3 | 18.7 |
| 700 | | 0.3 | 0.6 | 1.1 | 1.8 | 2.6 | 3.5 | 4.6 | 5.8 | 7.1 | 8.6 | 10.3 | 12.0 | 14.0 | 16.0 |
| 800 | | 0.3 | 0.6 | 1.0 | 1.6 | 2.2 | 3.1 | 4.0 | 5.1 | 6.2 | 7.6 | 9.0 | 10.5 | 12.2 | 14.0 |
| 900 | | 0.2 | 0.5 | 0.9 | 1.4 | 2.0 | 2.7 | 3.6 | 4.5 | 5.6 | 6.7 | 8.0 | 9.4 | 10.9 | 12.5 |
| 1000 | | 0.2 | 0.5 | 0.8 | 1.3 | 1.8 | 2.4 | 3.2 | 4.0 | 5.0 | 6.0 | 7.2 | 8.4 | 9.8 | 11.2 |

Source: AASHTO – Guide For The Development of Bicycle Facilities

TABLE A-5-11
MINIMUM LATERAL CLEARANCE FOR HORIZONTAL CURVES

* Rev.7/13

Bicyclists frequently ride side-by-side on shared use paths, and on narrow paths bicyclists have a tendency to ride near the middle of the path. For these reasons, and because of the higher potential for bicycle crashes, lateral clearances on horizontal curves should be calculated based on the sum of the stopping sight distances for bicyclists traveling in opposite directions around the curve. Where this is not possible or feasible, consideration should be given to widening the path through the curve, installing a yellow center line stripe, installing a “Curve Ahead” warning sign in accordance with the MUTCD, or some combination of these alternatives.

- Path-Roadway Intersections

Intersections between paths and roadways are often the most critical issue in shared use path design. Due to the potential conflicts at these junctions, careful design is of paramount importance to the safety of path users and motorists. Solutions are provided in the AASHTO guide and should be considered as guidelines, and not as absolutes. Each intersection is unique, and will require sound engineering judgment on the part of the designer as to the appropriate solution. Shared use paths should cross roadways as close to an intersecting road as practical, however, in no case should the crossing be closer than 4 feet from the edge of the parallel travelway. As the Path approaches the crossing it should be aligned with the destination of the crossing on the other side of the road. CG-12 Curb should be appropriately aligned and be the same width as the path. The crossing should also be perpendicular (or nearly so) to the road being crossed. Normally, two CG-12 curb are recommended at each corner where a path crosses an intersection. Sight distance should be evaluated and sound engineering judgment must be used in locating crossings. There may be situations, such as low traffic volumes where the crossing should be located further from the intersection.

When a Shared Use Path intersects a road, with no sidewalk, the path should slope to a relatively level (1%± slope) area at the road elevation and the curb opening should be the same width as the path. The level area shall have a Detectable Warning Surface in accordance with [IIM-LD-55](#). If a sidewalk intersects a Shared Use Path, then the sidewalk must also slope to the same relatively level area as the Shared Use Path.

Where a Shared Use Path cross an unpaved road or driveway, the road or driveway shall be paved a minimum of 20 feet on each side of the Shared-Use Path to reduce the amount of gravel scattered onto or along the path by motor vehicles. The pavement structure at the crossing shall be adequate to sustain the expected loading at that location. At a minimum, the pavement structure shall be the same as the Shared Use Path pavement structure.*

* Rev. 1/14

- Signing and Marking

Adequate signing and marking are essential on shared use paths, especially to alert bicyclists to potential conflicts and to convey regulatory messages to both bicyclists and motorists at highway intersections. In addition, guide signing, such as to indicate directions, destinations, distances, route numbers and names of crossing streets, should be used in the same manner as they are used on highways. In general, uniform application of traffic control devices, as described in the [MUTCD](#), provides minimum traffic control measures which should be applied.

- Pavement Structure

Hard, all weather pavement surfaces (such as asphalt or concrete) are preferred over those of crushed aggregate, sand, clay, or stabilized earth since these materials provide a much lower level of service and require higher maintenance.

The pavement structure below, Figure A-5-6.1, shall be used and shown on the pavement typical section sheet of the plans unless otherwise directed by the District Materials Engineer. Any additional information, such as changes in pavement depths, treatment of unsuitable materials, etc. shall be provided by the District Materials Engineer. Compaction of the asphalt concrete shall be completed by a minimum of 5 passes of a 8 ton smooth drum roller (no vibration). Density shall not be measured in accordance with the Roads and Bridge Specifications. This pavement structure typical section can be found in the CADD cell library under the name: Shared-Use Path Pavement Structure.*

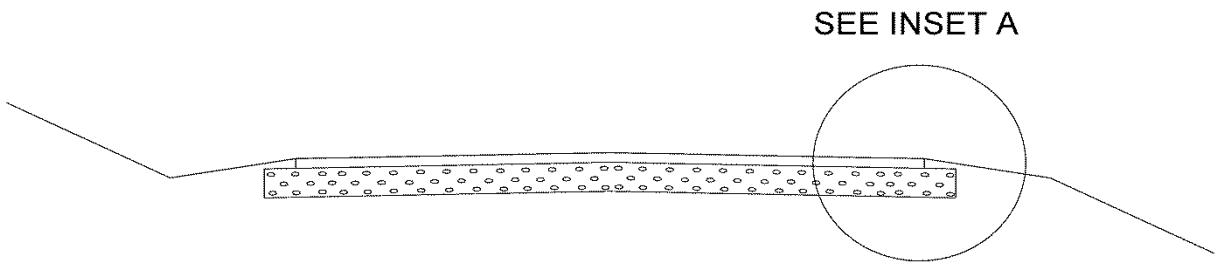

Note: For dimensions, slopes and offsets, see Appendix A, Figure A-5-5

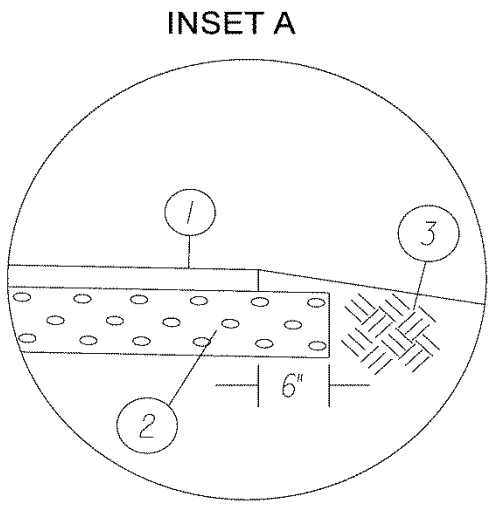

- ① 2" ASPHALT CONCRETE
SM-9.5A/SM-9.5AL @
approximately 220 lbs./Sq. Yds.
- ② 6" AGGREGATE BASE MATERIAL
TYPE I, OR II, NO. 21A OR 21B
- ③ REGULAR FILL MATERIAL
OR NATIVE SOIL

FIGURE A-5-6.1 SHARED USE PATH PAVEMENT STRUCTURE*

* Added 1/16

- Drainage

The recommended minimum pavement cross slope of 2 percent adequately provides for drainage. Sloping in one direction instead of crowning is preferred and usually simplifies the drainage and surface construction. A smooth surface is essential to prevent water ponding and ice formation. On unpaved shared use paths, particular attention should be paid to drainage to avoid erosion.

- Lighting

Lighting for shared use paths is important and should be considered where night usage is expected, such as paths serving college students or commuters, and at highway intersections. Lighting should also be considered through underpasses or tunnels, and when nighttime security could be an issue.

- Restriction of Motor Vehicle Traffic

Shared use paths may need some form of physical barrier at highway intersections to prevent unauthorized motor vehicles from using the facilities. Provisions can be made for a lockable, removable (or reclining) barrier post to permit entrance by authorized vehicles.

- Railroad Crossings

Railroad-highway grade crossings shall be at 60° to 90° degrees with the 90° degrees being the ideal crossing angle to the rails.* The greater the crossing deviates from this ideal crossing angle, the greater is the potential for a bicyclist's front wheel to be trapped in the flangeway causing loss of steering control. Consideration should be given to the crossing surface materials and to the flangeway depth and width.

* Rev. 1/15

- Bicycle Facilities Through Interchange Areas

Turning roadways provided for interchange ramp ingress and egress often require bicyclists to perform merging, weaving or crossing maneuvers with other vehicles. These conflict points are made challenging when a wide disparity in speed exists between traffic on the ramp and bicycle traffic crossing the ramp, and when grade separations create significant profile gradients. If a bike lane or route must traverse an interchange area, these intersection or conflict points should be designed to limit the conflict areas or to eliminate unnecessary uncontrolled ramp connections to urban roadways.

- Structures

On new structures, the minimum clear width shall be the same as the approach paved shared use path, plus the minimum 2 foot wide clear areas on both sides of the path. Carrying the clear areas across the structures provides a minimum horizontal shy distance from the railing or barrier and it provides needed maneuvering space to avoid conflicts with pedestrians and other bicyclists who are stopped on the bridge. Railings, fences, or barriers on both sides of a path on a structure shall be a minimum of 54 inches (4.5 feet) high. In situations where the structure crosses a high speed or high volume road and objects are subject to being thrown (dangerously) off the structure, it may be desirable to totally enclose the path with fencing. Totally enclosing a path may also be desirable in other areas such as a waterway crossing.

When structures require a barrier separation between the travelway and the shared-use path see Figure A-5-9 for transition from roadway onto bridge.

- Drainage Grates*

Grates shall be placed perpendicular to the direction of travel and the gaps between the drainage grate and its frame shall not be greater than 1 inch. Grates shall be within 0.25 inch of the new road surface.

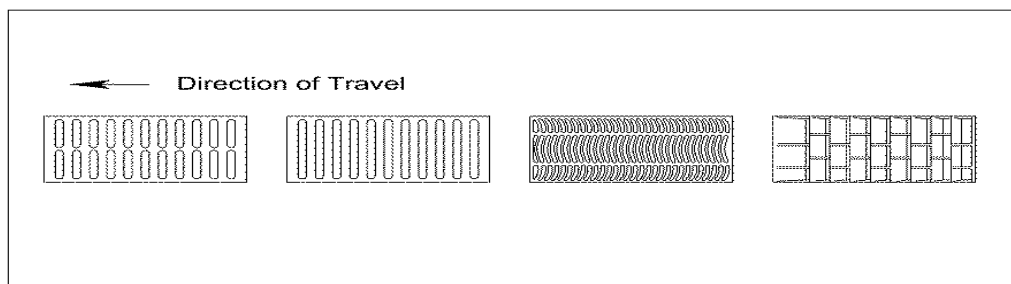

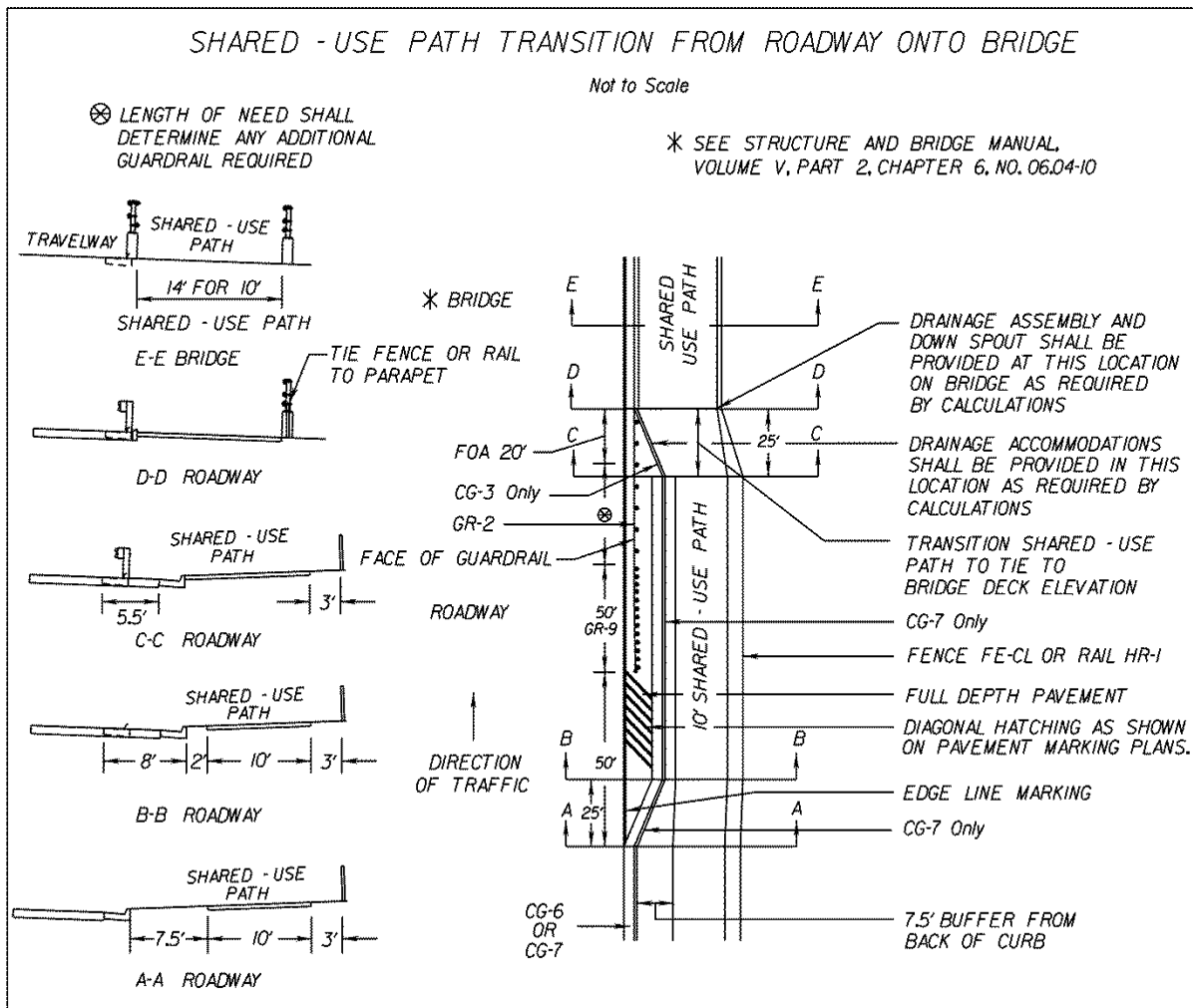

FIGURE A-5-9 SHARED USE PATH TRANSITION FROM ROADWAY ONTO BRIDGE FOR DESIGN SPEEDS >45 MPH*

AASHTO APPROVED INTERSTATE BICYCLE ROUTES

VDOT provides signing along the designated AASHTO approved Interstate Bicycle Routes. Figure A-5-10 shows the corridors for [Interstate Bicycle Routes 1 and 76](#) and the counties the routes pass through. The individual county maps provide detailed location information. County maps are to be checked by the plan designer to determine if their project is on a designated Interstate Bicycle Route. All proposed projects involving major construction or redevelopment along designated Interstate Bicycle Routes are to provide the necessary design features to facilitate bicycle travel in accordance with the parameters established in these guidelines.

* Rev. 1/13

RESOURCES

It should be understood that this Guide is not all inclusive. The publications listed below will provide additional information to be used in the design of bicycle facilities.

2012 "*Guide for the Development of Bicycle Facilities.*" AASHTO

2009 "*Manual on Uniform Traffic Control Devices.*" Federal Highway Administration

2012 NATCO "*Urban Bikeway Design Guide*", Second Edition*

"*Selecting Roadway Design Treatments to Accommodate Bicycles.*" Federal Highway Administration



"*A Virginia Guide for Bicycle Facility Planning.*" Virginia Department of Transportation

* Rev. 7/14

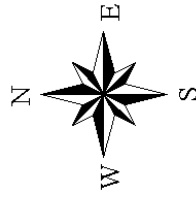
Interstate Bicycle Routes 1 and 76



Legend

-  Interstate Bicycle Route 1
-  Interstate Bicycle Route 76

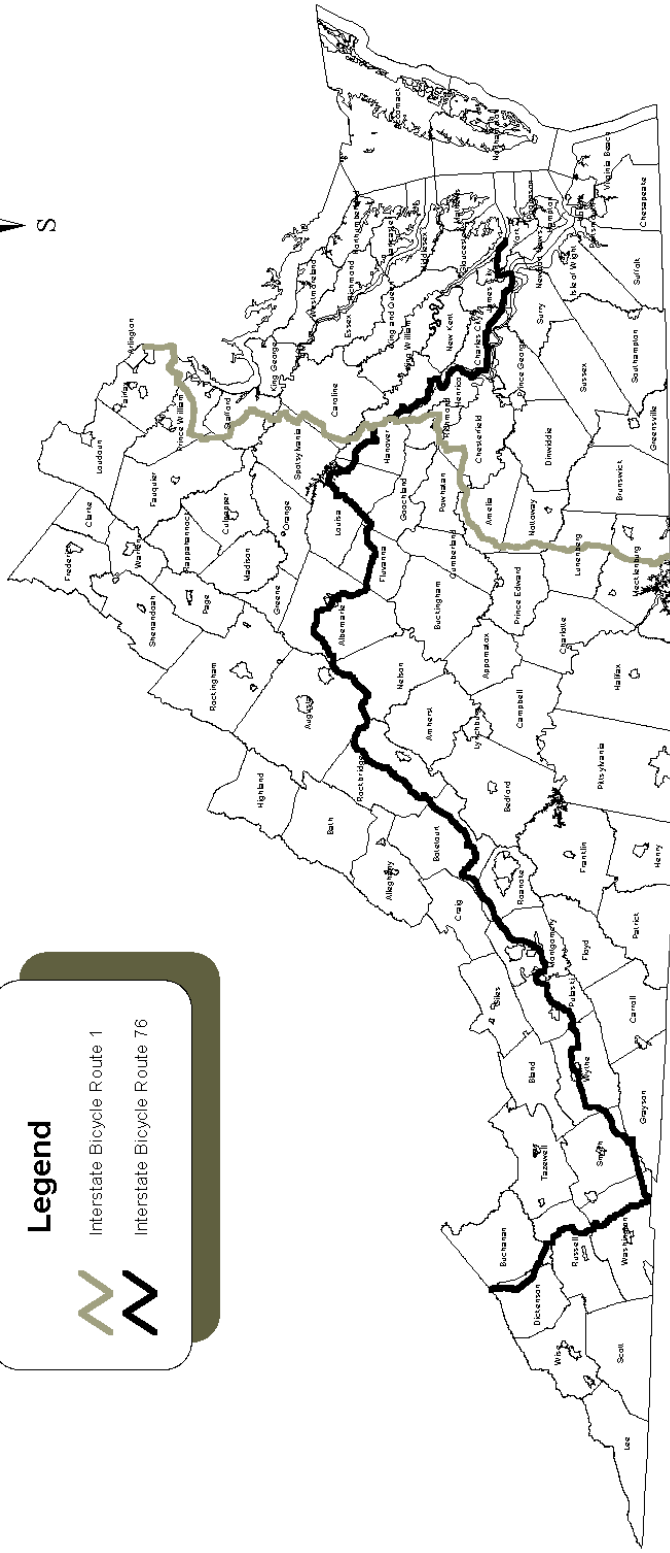

Figure A-5-10*

* Rev. 1/11

TRAILS AND TRAILHEADS

For more information see; [A Summary of Accessibility Standards for Federal Outdoor Developed Areas - United States Access Board.](#)*

Trails

Trails are defined in of the Final Guidelines for Outdoor Developed Areas can be accessed at <http://www.access-board.gov/guidelines-and-standards/recreation-facilities/outdoor-developed-areas/final-guidelines-for-outdoor-developed-areas/text-of-the-guidelines> as a pedestrian route developed primarily for outdoor recreational purposes. A pedestrian route developed primarily to connect elements, spaces, or facilities within a site is not a trail.

This term “Trail” means an unimproved or sometimes improved recreational facility intended for recreational use such as hiking, mountain biking or equestrians. Care should be taken not to use Share-use path and Trail interchangeably because they have distinctly different design guidelines. However, when any portion of a Trail can be constructed using Share-use path design criteria it should be and an over-look or passing area 5 feet by 5 feet shall be constructed to allow users to experience the Trail without blocking the Trail for other users.

For guidance on the design of Outdoor Recreation Access Routes, of the **Final Guidelines for Outdoor Developed Areas**, which can be accessed at <http://www.access-board.gov/guidelines-and-standards/recreation-facilities/outdoor-developed-areas/final-guidelines-for-outdoor-developed-areas/text-of-the-guidelines> and the **DCR Greenways and Trails Toolbox**, which can be accessed at http://www.dcr.virginia.gov/recreational_planning/greentrailtools.shtml

The scoping provisions for trails are contained in F247, which accessed at <http://www.access-board.gov/guidelines-and-standards/recreation-facilities/outdoor-developed-areas/final-guidelines-for-outdoor-developed-areas/text-of-the-guidelines> These provisions require trails to comply with the technical provisions for trails in 1017 when all the following conditions are met:

- The trail is newly constructed or altered so that the original design, function, or purpose of the trail is changed. Routine or periodic maintenance activities that are performed to return an existing trail to the condition to which the trail was originally designed are not alterations.
- The trail is designed for pedestrian use.
- The trail connects to a trailhead or to another trail that complies with the technical provisions in 1017.

- The technical provisions for trails in 1017 <http://www.access-board.gov/guidelines-and-standards/recreation-facilities/outdoor-developed-areas/final-guidelines-for-outdoor-developed-areas/text-of-the-guidelines> address surface in 1017.2; clear tread width in 1017.3; passing spaces in 1017.4; tread obstacles in 1017.5; openings in 1017.6; slopes in 1017.7; resting intervals in 1017.8; protruding objects in 1017.9; and trailhead signs in 1017.10.

The technical provisions are the same as in the NPRM, except as follows:

Conditional exceptions apply to each technical provision for newly constructed and altered trails. The conditional exceptions are discussed under Conditional Exceptions.

The exception based on situations where it is impractical to require the entire trail to comply with the technical provisions is revised. The exception is discussed under Exceptions for Trails and Beach Access Routes.

Where concrete, asphalt, or boards are used, obstacles cannot exceed ½ inch in height and the cross slope and resting interval slope cannot exceed 1:48. These provisions are discussed under Concrete, Asphalt, or Board Surfaces.

The NPRM exceptions for openings are included in 302.3 of the ADA-ABA Accessibility Guidelines.*

Where resting intervals are provided adjacent to the trail, a turning space is required.

Provisions are added for gates and barriers constructed to control access to trails.

The scoping provisions for trails also address camping facilities, picnic facilities, viewing areas, and outdoor constructed features provided on trails. These facilities are required to comply with the applicable scoping and technical provisions for each facility, regardless of whether the trail complies with the technical provisions in 1017. Individuals with disabilities use trails that do not comply with the technical provisions of 1017 and, therefore, facilities provided on such trails are required to be accessible. Camping facilities, picnic facilities, viewing areas, and outdoor constructed features provided on trails are connected to a trail, and are not required to be connected to an outdoor recreation access route. See 1019 Conditions for Exceptions.

* Added 7/11

Trailhead*

Trailheads are defined in F106.5 as an outdoor space developed to serve as an access point to a trail. The junction of two or more trails, where no other access point is provided to the trails, is not a trailhead.

The scoping provisions for trailheads are contained in F247.3 <http://www.access-board.gov/guidelines-and-standards/recreation-facilities/outdoor-developed-areas/final-guidelines-for-outdoor-developed-areas/text-of-the-guidelines>. The provisions require new signs provided at trailheads on newly constructed or altered trails to include information on the length of the trail or trail segment; surface type; typical and minimum tread width; and typical and maximum running slope and cross slope. The U.S. Forest Service currently provides this information on trailhead signs posted on certain trails in national forests.

The scoping provisions require at least 20 percent of each type of outdoor constructed feature provided within a trailhead to be accessible. The scoping provisions also require an outdoor recreation access route to connect accessible parking spaces or other site arrival points to the accessible outdoor constructed features, elements, spaces, and facilities within the trailhead.

Resources:

For guidance on the design of Outdoor Recreation Access Routes, see Section 1017 of the **Final Guidelines for Outdoor Developed Areas**, dated September 26, 2013, which can be accessed at <http://www.access-board.gov/guidelines-and-standards/recreation-facilities/outdoor-developed-areas/final-guidelines-for-outdoor-developed-areas/text-of-the-guidelines> and the **DCR Greenways and Trails Toolbox**, which can be accessed at http://www.dcr.virginia.gov/recreational_planning/greentrailtools.shtml

* Added 7/11

RAILS – WITH – TRAILS

“Rails-with-Trails” (RWT) describe any shared-use path or trail adjacent to an active railroad corridor. These trails are located adjacent to active rail lines ranging from a few slow-moving short-haul freight trains weekly, to high-frequency Amtrak trains traveling as fast as 140 mph. Like shared-use paths, RWT’s are used by bicyclists and pedestrians. Many of the characteristics of shared-use paths are also common to RWT’s. These include continuous separation from motor vehicle traffic; frequent access points; increased levels of safety and security; scenic qualities; connectivity to a variety of land uses, etc. RWT’s can bring numerous benefits to communities and railroads alike. Working closely with railroad companies and other stakeholders is critical to a successful RWT. Limiting new and/or eliminating at-grade RWT crossings, separating trails back as far as possible from tracks and providing physical separation through fencing, vertical distance, vegetation and/or drainage ditches can help create a well-designed trail. See Figure A-5-11 and Table A-5-12* for minimum separation distance between active rails and paths (RWT).

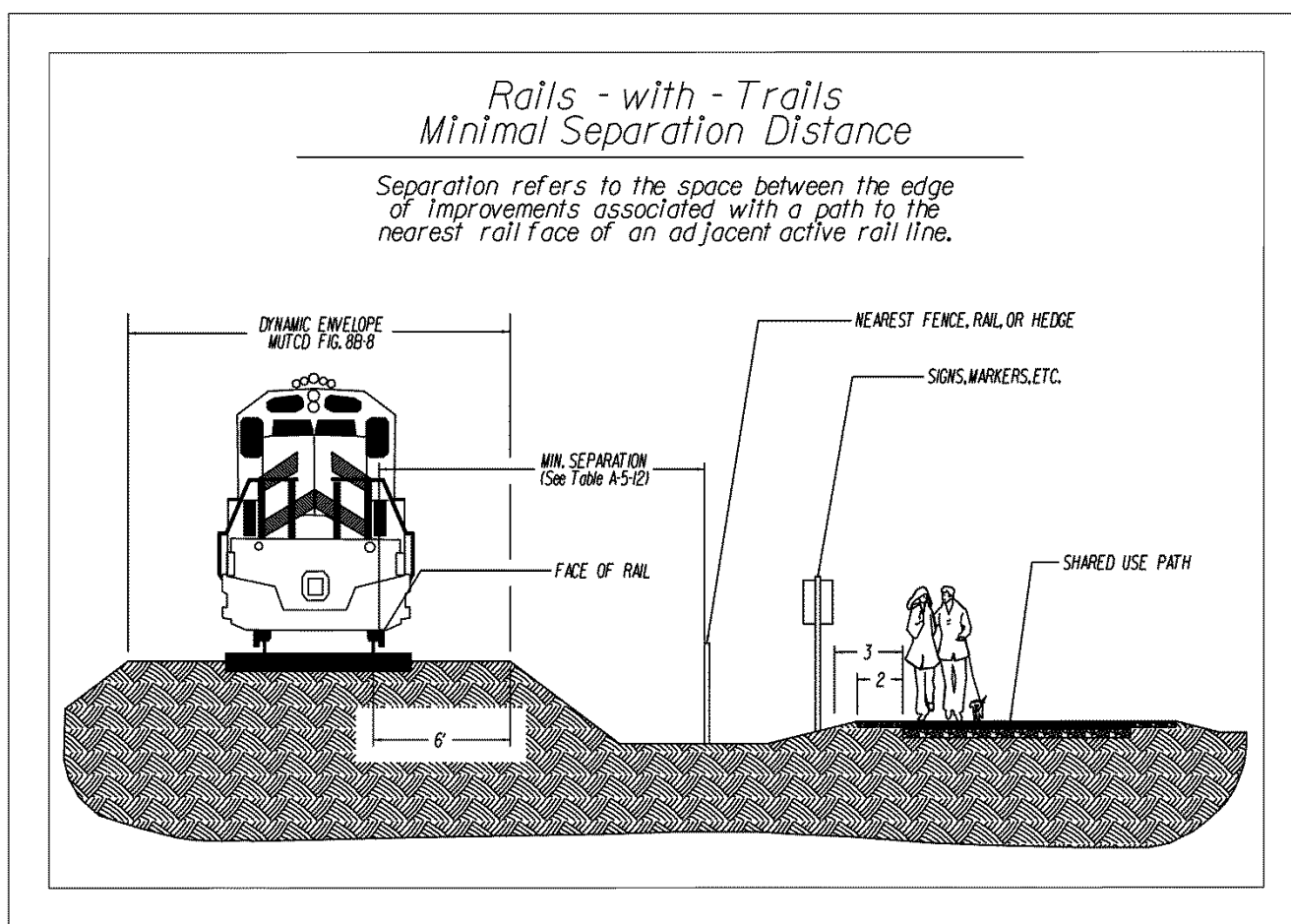

Source: Adapted from the *VTrans Pedestrian and Bicycle Facility Planning and Design Manual*

FIGURE A- 5-11 SEPARATION BETWEEN ACTIVE RAIL LINES AND PATHS (RWT)

* Rev. 1/13

| Recommended Separation between Active Rail Lines and Paths (RWT) | | |
|---|---|--|
| Type of Rail Operation | Setting Characteristic | Recommended Minimum Separation |
| High Volume/High Speed | | |
| 11 trains or more per day Max speed over 45 mph | Typical Conditions | 25 feet with fence |
| | | 15 feet with a solid barrier |
| | Constrained Areas (cut/fill, bridges, etc.) | 15 feet with fence or other physical barrier |
| | Vertical Separation of at least 10 feet | 20 feet |
| Medium Volume/Medium Speed | | |
| Fewer than 11 trains per day Max speed 45 mph | Typical Conditions | 25 feet |
| | | 15 feet with physical barrier |
| | Constrained Areas | 11 feet with physical barrier |
| | High Trespassing Areas | 11 feet with physical barrier |
| Low Volume/Low Speed | | |
| Fewer than 11 trains per day Max speed 45 mph | Typical Conditions | 25 feet desired |
| | | 11 feet minimum |
| | Constrained Areas | 11 feet with physical barrier |

Adapted from FHWA Rails with trails Lessons Learned
Source: *VTrans Pedestrian and Bicycle Facility Planning and Design Manual*

TABLE A- 5-12 SEPARATION BETWEEN ACTIVE RAIL LINES AND PATHS (RWT)

For additional information on Rails-With-Trails* ;

https://www.fhwa.dot.gov/environment/recreational_trails/publications/rwt/index.cfm and
<http://www.railstotrails.org/ourWork/reports/railwithtrail/report.html>

CURB RAMP AND PEDESTRIAN ACCESS ROUTE GOALS AND OBJECTIVES*

The Project Manager is to coordinate, early in the design process, with the Project Traffic Engineer concerning crosswalk locations to determine the most desirable road crossing locations. Proposed curb ramp locations, the pedestrian access route, and sidewalks are to be reviewed with the Location and Design Traffic Engineering Design Section early in the design process and throughout the plan development process to determine any possible conflicts with traffic control devices, signs, signals, signal boxes, lighting, crosswalks, and stop bars and other pavement markings. Proposed curb ramp locations also are to be reviewed also by the Hydraulics Section and any other affected disciplines (such as utilities) to avoid potential drainage problems or other conflicts.

CURB RAMPS

A curb ramp is required to provide access to and from pedestrian access routes (sidewalk or sidewalk space) for all users. This access is beneficial to pedestrians, users of wheelchairs, canes, crutches, walkers, braces, lower-limb prostheses, persons with gait balance and stamina disabilities, the elderly, and persons with visual disabilities (such as depth perception difficulties).

There are four objectives related to this goal:

1. Provide a curb ramp design and placement that is usable by persons with disabilities.
2. Provide design and placement alternatives for a range of sidewalk and street conditions.
3. Provide minimal negative impact to all pedestrians.
4. Place curb ramps in uniform and consistent locations.

Pedestrians with disabilities will benefit most from design approaches that minimize physical barriers to travel and maneuverability. Pedestrians who use crutches are particularly susceptible to cross slope when they are traveling downhill. Pedestrians with cognitive and sensory disabilities, particularly those who have limited vision and those who are blind, should have access to information on the pedestrian environment that is necessary for independent travel. Children, including those with disabilities and those using bicycles and other wheeled toys, are significant users of sidewalks and are significantly less able to compensate for cross slope than adults.

* Rev. 7/14

MISCELLANEOUS NOTES

Objects such as utility covers, manhole covers, vault frames and covers and grates shall not be located on curb ramp runs, blended transitions, turning spaces or the gutter area within the pedestrian access route. This may not always be possible in alterations, but should be avoided wherever possible.*

Maintenance of curb ramps may be necessary where there is a low velocity of storm water runoff. Debris may accumulate in the relatively flat areas at the base of the ramps, particularly in CG-12, Type B. Very little can be done cost-effectively to overcome this from a design and placement perspective.

The design guidelines are based on a standard barrier curb height of 6 inches. Should increased heights be used, it will be necessary to add to the length of the curb ramp.

Special attention should be given to ensure that the bottoms of curb ramps and gutter pan lips are not adversely affected during street re-paving.

When new construction or an alteration activity is conducted, curb ramp access must be evaluated as part of the project design.

Gutter slopes at curb ramp locations should not exceed 20:1 (5%) for new construction. Therefore, VDOT's standard curb and gutter design should be modified for use adjacent to curb ramps to ensure proper slope and adequate drainage.

The minimum requirements for curb ramps differ for new construction and alterations.

GUIDELINES FOR CURB RAMP LOCATIONS

The placement of curb ramps is as critical to their effectiveness as the design. Placement should be determined by design constraints of the sidewalk, roadway, and intersection with respect to obstructions, crosswalks, and intersection types. Placement relative to obstructions should maintain consistency and effectiveness.

One curb ramp shall be provided for each direction of an intersection crossing, where feasible. Curb ramps shall be in-line with the direction of pedestrian travel to improve wayfinding for visually impaired pedestrians.

Curb ramps shall be located within the crosswalks (marked or unmarked). The ramps may be centered or located to one side of the crosswalk with the flare outside of the crosswalk. Curb ramps shall be located in front of the vehicle stop bar, if one exists. The Project Manager should discuss the relationship between crosswalks, stop bars and curb ramps with the Traffic Engineering Designer throughout the design of a project.

* Rev. 7/15

Pedestrian Access Routes that cross medians and refuge islands shall be a minimum of 6 feet in length and include a break or cut-through a minimum of 5 feet wide and include detectable warning surfaces. Detectable warning surfaces shall be truncated domes. See VDOT Road and Bridge Standard CG-12 and Median (M1 or M2) or Refuge Island (RI1 or RI2).

Typical situations depicting the placement of curb ramps in new construction and in alterations have been incorporated into VDOT's [Road and Bridge Standard](#) details. Designers are urged to use sound engineering judgment in determining placement.

Curb ramps should be provided for each direction of crossing at intersections that incorporate pedestrian access routes, or on both sides of a mid-block location to establish a pedestrian access route for ramp users. If curb ramps are not placed at all corners of an intersection the ramp user's accessibility is restricted to the paths that provide curb ramps. Access to all pedestrian paths should be provided.

On new construction projects, utility poles, traffic control devices (such as sign, signal and lighting structures), fire hydrants, and drop inlets should be located so as to provide an unobstructed pedestrian access route to the curb ramp. Because the location of curb ramps may be adversely affected by obstructions, the curb ramp location should have priority over the location of potential obstructions.

CURB RAMP ELEMENTS AND TYPES*

RAMP

A curb ramp consists of a ramp, with a maximum running slope of 12:1 (8%) and its accompanying landing(s), with flares on each side where appropriate. A ramp can cut through a median curb or rise up to the landing or Pedestrian Access Route.

LANDING

A level area of a curb ramp with a cross slope of less than 48:1 (2%). For perpendicular curb ramps, the landing allows pedestrians to bypass the flares and ramp and provides a level maneuvering space for persons using wheelchairs entering or exiting the ramp. For parallel curb ramps, the landing is between the ramps. The landing clear width shall be at least as wide as the curb ramp, excluding flared sides, leading to the landing. In alterations, where there is no landing at the top of the curb ramp, the curb ramp flares shall be provided and shall not be steeper than 12:1 (8%). See drawing below as well as the Road and Bridge Standards.

The type of curb ramp is determined by the direction the user is traversing the ramp in relation to the vehicular path of travel. The three (3) types of curb ramps are: Perpendicular Design (CG-12, Type A), Parallel Design (CG-12, Type B) and Combined (Parallel and Perpendicular) Design (CG-12, Type C).

* Rev. 7/14

PERPENDICULAR CURB RAMP (CG-12, TYPE A)

A curb ramp, normally perpendicular to the curb at the street crossing, with a maximum running slope of 12:1 (8%) and a 48:1 (2%) maximum level landing (4 feet x 4 feet minimum) at the top. The bottom of the ramp run, exclusive of flared sides (10:1 (10%) maximum slope), shall be located within the crosswalk. The cross slope shall be 48:1 (2%) maximum. Sidewalks are permitted to follow the running slope of the adjacent roadway, which determines the cross slope of perpendicular ramps and landings at mid-block crossings. **One curb ramp shall be provided for each direction of intersection crossing, where feasible.** (See Standard CG-12, Type A in the VDOT [Road and Bridge Standards](#).)

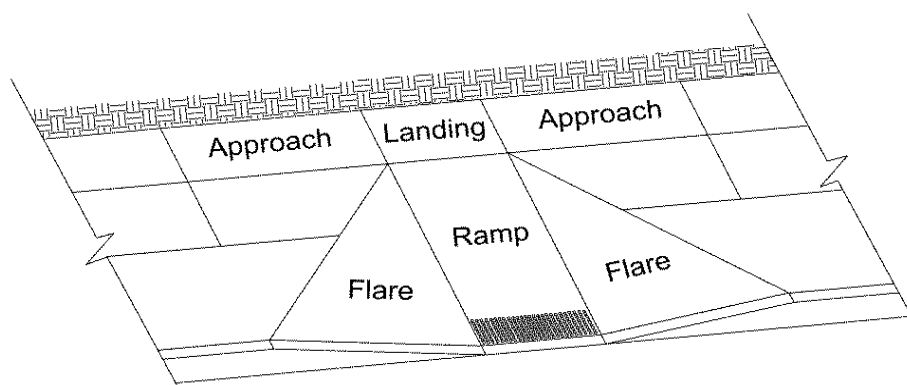

FIGURE A-5-12 PERPENDICULAR CG-12, TYPE A*

* Rev. 7/14

PARALLEL CURB RAMP (CG-12, TYPE B)

Parallel ramps are especially suited to narrow rights-of-way where there is insufficient space for the top landing of a perpendicular curb ramp. In this case, the bottom landing usually serves as the direct connection to the street crossing and shall be located within the crosswalk. Criteria for parallel curb ramps address the running slope (grade) (12:1 (8%) maximum and 48:1 (2%) minimum), cross slope (48:1 (2%) maximum), level landings at the bottom at least 5 feet by 5 feet, and barriers at drop-offs. The running slope (grade) of parallel curb ramps will be affected by the slope of the sidewalk, which is permitted to be as steep as the adjacent roadway. Thus, a maximum slope of 12:1 (8%) may not be achievable due to the road grade. In recognition of this, an exception limits the required length of a parallel ramp to 15 feet, regardless of the slope. The landing required at the bottom of the ramp is not permitted to slope more than 48:1 (2%) in any direction. **One curb ramp shall be provided for each direction of intersection crossing, where feasible.** (See Standard CG-12, Type B in the VDOT [Road and Bridge Standards](#).)

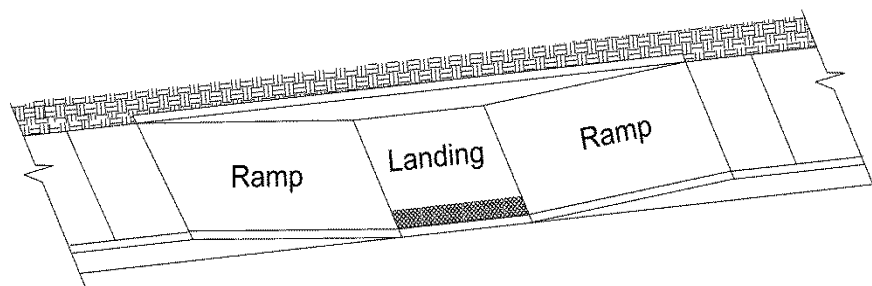

FIGURE A-5-13 PARALLEL CG-12, TYPE B*

* Rev. 7/14

COMBINED (PARALLEL & PERPENDICULAR) CURB RAMP (CG-12, TYPE C)

This alternative is typically used when public pedestrian right of way width established by local or state regulation, guideline, or practice will not accommodate a perpendicular curb ramp. A segment of the sidewalk is ramped or depressed to a relatively level landing to accomplish part of the level change and the balance is achieved by a short perpendicular curb ramp. **One curb ramp shall be provided for each direction of intersection crossing, where feasible.** (See Standard CG-12, Type C in the VDOT [Road and Bridge Standards](#).)

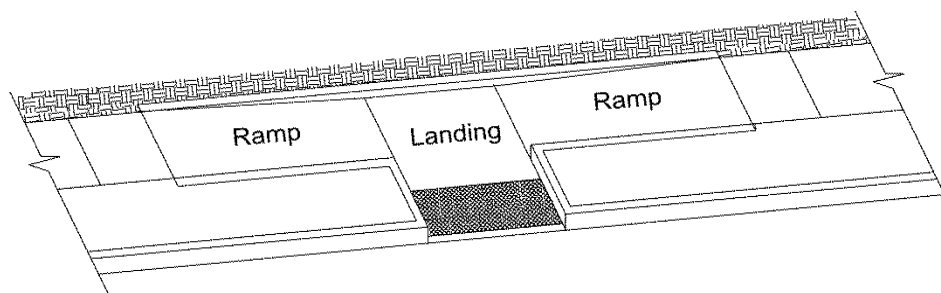

FIGURE A-5-14 PARALLEL AND PERPENDICULAR CG-12, TYPE C*

PEDESTRIAN ACCESS ROUTE

A Pedestrian Access Route provides a continuous accessible means of passage from one location to another within public right-of-way. New Pedestrian Access Routes (Sidewalks or Sidewalk Space) shall be 5 feet wide excluding the width of curb. However, in unique situations where this is not feasible, a minimum clear width of 4 feet shall be provided excluding the width of curb. Pedestrian Access Routes less than 5 feet excluding the width of curb require the submission of a Design Waiver (See [IIM-LD-227](#)). **Design Exceptions are not applicable for sidewalks less than 4 feet wide.**

* Rev.7/14

New Pedestrian Access Routes (Sidewalk or Sidewalk Space) less than 5 feet in continuous width excluding the width of curb shall provide a pedestrian passing area a minimum of 5 feet x 5 feet at reasonable intervals not to exceed 200 feet. These passing areas can be provided at street intersections with cross slopes no greater than 48:1 (2%).

Where pedestrian access routes are contained within a street or highway right-of-way, the grade of pedestrian access routes shall not exceed the general grade established for the adjacent street or highway. Where pedestrian access routes are not contained within a street or highway right-of-way, the grade of pedestrian access routes shall be 5% maximum.

The pedestrian access route surfaces shall be firm, stable, and slip resistant and openings that are more than ½ inch in one dimension are prohibited. The pedestrian access route is permitted level changes up to ¼ inch without treatment and level changes between ¼ inch and ½ inch that are beveled with a slope no greater than 2:1.

NEW CONSTRUCTION

All areas of newly designed and newly constructed facilities in public rights of way are subject to these guidelines. This applies to work such as the extension of roadways and sidewalks into undeveloped areas, new subdivisions, and similar types of projects. Full compliance is generally easier in these types of projects because the scope of work is usually extensive enough to allow necessary grading and acquisition of sufficient right of way.

TECHNICALLY INFEASIBLE

Existing physical or site development conditions that prohibit the modification or incorporation of elements, spaces, or features which are in full and strict compliance with the minimum requirements for new construction in the public right of way and which are necessary for pedestrian access, circulation, and use (the basis used for exceptions and special technical provisions allowed in alterations). (Source: FHWA Office of Civil Rights Memorandum dated September 12, 2006).

http://www.fhwa.dot.gov/environment/bicycle_pedestrian/guidance/accessibility_guidance/prwa_a.cfm.

When an alteration meets accessibility requirements but is technically infeasible, the public agency must ensure that the alteration provides accessibility to the “maximum extent feasible”.

* Rev. 7/14

ALTERATIONS

An alteration is a change to a facility in the public right-of-way that affects or could affect access, circulation, or use. Projects altering the use of the public right-of-way must incorporate pedestrian access improvements within the scope of the project to meet the requirements of the ADA and Section 504. These projects have the potential to affect the structure, grade, or use of the roadway. Alterations include items such as reconstruction, rehabilitation, widening, resurfacing (see [USDOJ-FHWA technical assistance dated 6-28-13 for additional clarification](#)), pedestrian signal installation, signal installation and upgrades, and projects of similar scale and effect (6-28-2013).*

Alterations shall incorporate accessibility improvements to existing pedestrian facilities to the extent that those improvements are in the scope of the project and are technically feasible, without regard to cost. Projects altering the usability of the roadway must incorporate accessible pedestrian improvements concurrent with the alterations to the roadway.

The DOJ does not consider maintenance activities, such as filling potholes, to be alterations. The DOJ does consider resurfacing beyond normal maintenance to be an alteration. *DOJ's ADA Title II Technical Assistance Manual*, § II-6.6000, 1993, [USDOJ-FHWA Technical Assistance dated 6-28-2013](#) and <http://www.ada.gov/doj-fhwa-ta-glossary.htm>

The FHWA has determined that maintenance activities include actions that are intended to preserve the system, retard future deterioration, and maintain the functional condition of the roadway without increasing the structural capacity. These activities include, but are not limited to, joint repair, pavement patching (filling potholes), shoulder repair, signing, striping, minor signal upgrades, and repairs to drainage systems. (6-28-2013)

For additional information, see the following:

Special Report: Accessible Public Right-of-Way Planning and Designing for Alterations dated August 31, 2007, which can be accessed at:

<http://www.access-board.gov/guidelines-and-standards/streets-sidewalks/public-rights-of-way/guidance-and-research/accessible-public-rights-of-way-planning-and-design-for-alterations>

Questions and Answers About ADA/Section 504, which can be accessed at: http://www.fhwa.dot.gov/civilrights/programs/ada_sect504qa.cfm#q17

U.S. Access Board, Chapter 2 - Alterations

<http://www.access-board.gov/guidelines-and-standards/streets-sidewalks/public-rights-of-way/guidance-and-research/accessible-public-rights-of-way-planning-and-design-for-alterations/chapter-2%e2%80%94alterations>

* Rev. 7/15

PROCEDURE FOR DETERMINING THE LOCATION AND DESIGN OF CURB RAMPS*

Where do we want and plan for all pedestrians to walk or move? What is their destination and what is their current path? Is there an established network? The path may be along a sidewalk (or a relatively flat, unobstructed grass area behind a curb even though it is not surfaced) and through intersections.

1. Determine if the subject project is a new project or an alteration project.
2. Coordinate, early in the design process, with the State Bicycle and Pedestrian Coordinator concerning a pedestrian movement plan (pedestrian access route) Policy and Procedure Section and the Traffic Engineering Designer concerning crosswalk locations. Determine the most desirable crossing locations.
3. Determine the best type of curb ramp (CG-12, Type A, B or C) for each location. Specify a CG-12, Type A if there is sufficient space for the landing at the top of the ramp.
4. Evaluate conflicts with curb ramps (light poles, fire hydrants, traffic control devices, utilities, drainage structures, etc.) and coordinate revised crossing locations or fixed object locations as necessary to install curb ramps.
5. The above procedure should continue as necessary throughout the plan development process.

GUIDELINES FOR ALTERATIONS

When existing areas, elements, or facilities intended for pedestrian access, circulation, and use in an existing developed public facility are altered, that is considered an alteration.

An alteration of an existing element, space, or area of a building or facility shall not impose a requirement for accessibility greater than required for new construction.

In alterations, where compliance with applicable requirements for new construction is technically infeasible, the alteration shall comply with the requirements to the "maximum extent feasible".

An alteration that decreases or has the effect of decreasing the accessibility of a public building or facility below the requirements for new construction at the time of the alteration, is prohibited.

If alterations to existing sidewalks curb ramps, or pedestrian street crossings, when considered together amount to reconstruction of a block, intersection, or other substantial segment of the pedestrian circulation network in the public right of way, the entire segment, to the "maximum extent feasible", shall comply with provisions for new construction.

Alterations to a sidewalk, curb ramp, or pedestrian street crossing in the public right of way shall be made so that adjacent segments on the pedestrian access route are readily accessible to and usable by individuals with disabilities.

* Added. 7/10

Ramps, curb ramps and exterior ramps to be constructed on sites or in existing facilities where space limitations prohibit the use of a 12:1 (8%) slope or less may have slopes and rises as follows:

- A slope between 10:1 (10%) and 12:1 (8%) is allowed for a maximum rise of 6".
- A slope between 8:1 (12.5%) and 10:1 (10%) is allowed for a maximum rise of 3 inches. A slope steeper than 8:1 (12.5%) is not allowed.

In alterations, full extension of handrails shall not be required where such extensions would be hazardous due to the ramp configuration.

The guidelines apply technical requirements according to the scope of work for a planned alteration or addition. The more extensive the work is, the greater are the opportunities to achieve access. Compliance is "prorated" based on the extent of the work planned.

ALTERATION (RETROFIT) CG-12 INTO EXISTING CURB AND GUTTER AND/OR SIDEWALK LOCATIONS*

When retrofitting a CG-12 into an existing curb and gutter location and/or sidewalk location, evaluation must be made for the most appropriate type of CG-12 configuration to match existing conditions with consideration of grade, type of curb and gutter, pedestrian path, available crosswalks, R/W, location of utilities, location of drainage structures, and any other features that may prohibit or affect the placement and design of the curb ramp.

The existing curb and gutter (or curb only) will need to be removed in the area of the ramp. If there is existing sidewalk it may need to be removed back to the point where the proposed curb ramp will meet existing sidewalk grade. A new curb and gutter will need to be placed to match the existing edge of pavement and to tie to the proposed CG-12 as called for on the plans by type. (This may result in a warped surface area of 20:1 rather than normal gutter slope in the area approaching the ramp.) The sidewalk will be placed to meet the selected type of CG-12 shown on the plans and the detectable warning surface will be placed by the acceptable method selected by the contractor as shown in the Standard for CG-12. **If the landing area is placed at the top of the ramp (i.e.: CG-12, Type A) it may be constructed of the same surface as the traversable path (including grass) although it still must meet the minimal requirements of a landing (i.e.: within R/W, flat surface, correct size, etc.).**

For additional information on curb ramps and sidewalks, see [IIM-LD-55](#).

* Added 7/10

CURB RAMP APPLICATION DETAILS*

ONE CURB RAMP SHALL BE PROVIDED FOR EACH DIRECTION OF INTERSECTION CROSSING, WHERE FEASIBLE. (CG-12, TYPE A, B OR C)

TWO CG-12, TYPE B'S ARE SHOWN BELOW:

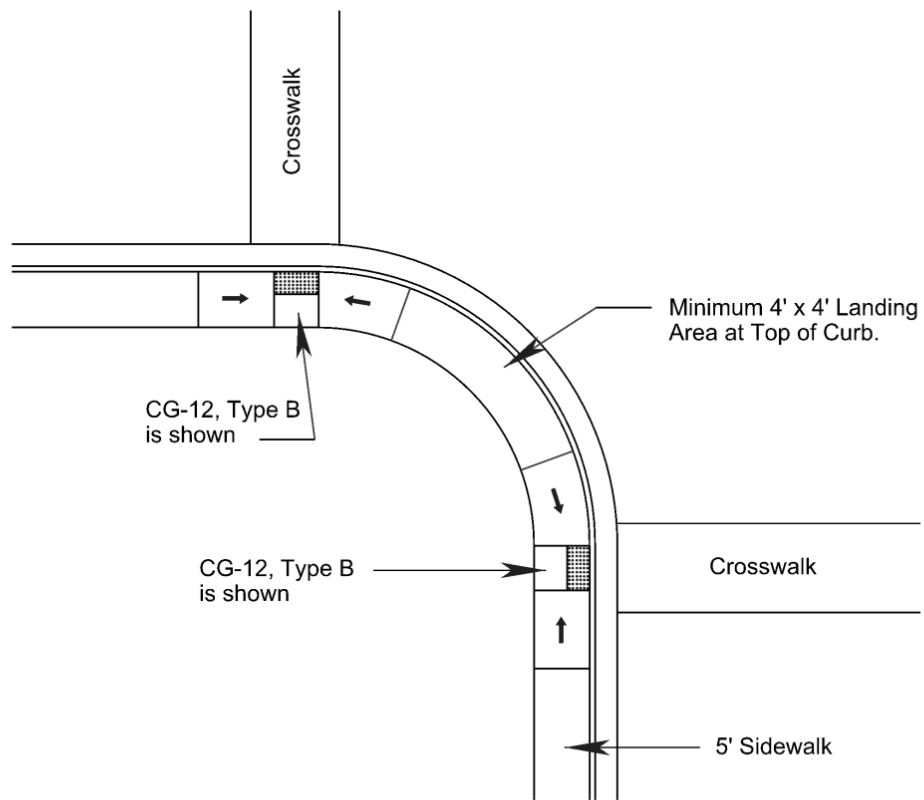

Ramp (with arrows) are 12:1 Maximum slope.

FIGURE A-5-15 TWO CG-12 TYPE B FOR EACH DIRECTION AT INTERSECTION

* Rev.7/14

DIAGONAL CURB RAMP

Diagonal or corner type curb ramps with returned curbs or other well-defined edges shall have the edges parallel to the direction of pedestrian flow. The bottom of diagonal curb ramps shall have a clear space 48" minimum outside active traffic lanes of the roadway.

Diagonal curb ramps provided at marked crosswalks shall provide the 48" minimum clear space within the markings. Diagonal curb ramps with flared sides shall have a segment of curb 24" long minimum located on each side of the curb ramp and within the marked crossing as shown below. CG-12's Type A, B and C can be constructed as Diagonal Curb Ramps. However certain criteria apply. See Figures A-5-16 and A-5-17* below for criteria.

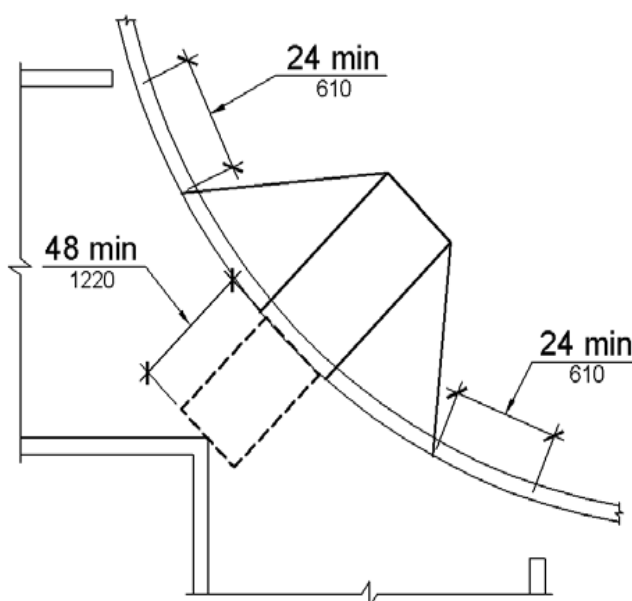

FIGURE A-5-16 DIAGONAL OR CORNER TYPE CURB RAMPS

* Rev. 7/14

Single Diagonal Parallel Curb Ramp, CG-12, Type B, with an Enlarged Landing Area (48" x 48" space may include gutter pan)*

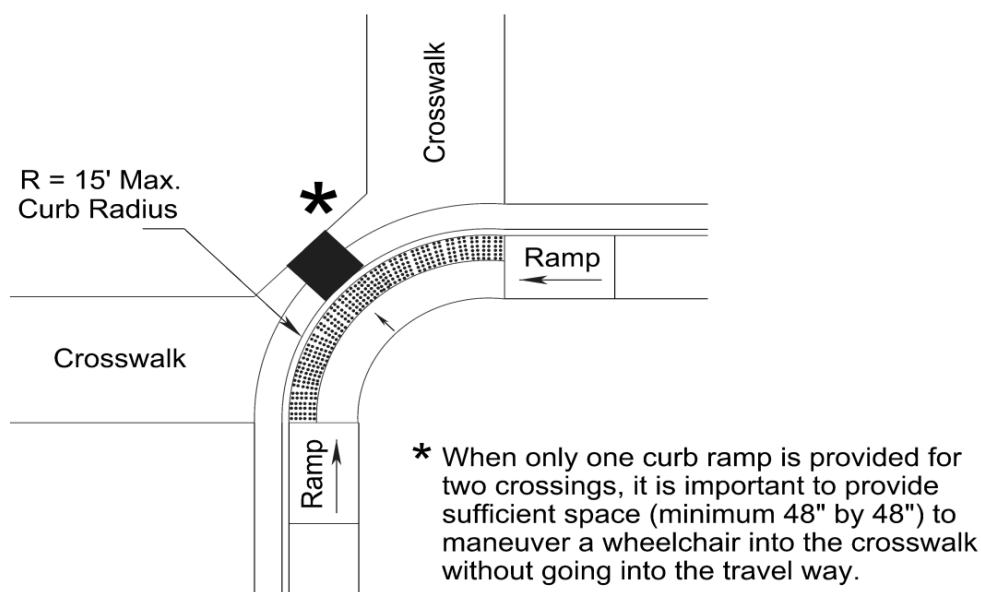

FIGURE A-5-17 SINGLE DIAGONAL PARALLEL CURB RAMP, CG-12, TYPE B

Diagonal curb ramps are **not** recommended for new construction. However, the Enlarged Landing Area layout above may be considered for new construction when the curb radius is 15 feet and less. In alterations, it may be considered when the distance between two CG-12, Type B's is insufficient to install a separate landing for each. This layout shall provide a level landing area or maneuvering space (48" x 48") at the bottom of the ramp and outside of the travelway as shown above.

Note: Diagonal curb ramps force pedestrians descending the ramp to proceed into the intersection before turning to the left or right to cross the street and therefore, make it more difficult for individuals with vision impairments to determine the correct crossing location and direction. Persons with visual impairments may also mistake a diagonal curb ramp for a perpendicular curb ramp and unintentionally travel into the middle of the intersection. Designer should consider the intersection skew when using this layout.

**Single Diagonal Parallel Curb Ramp, CG-12, Type B;
A Sufficient Maneuvering Space (48" x 48" which may include the gutter pan)
shall be provided for wheelchairs as shown below:***

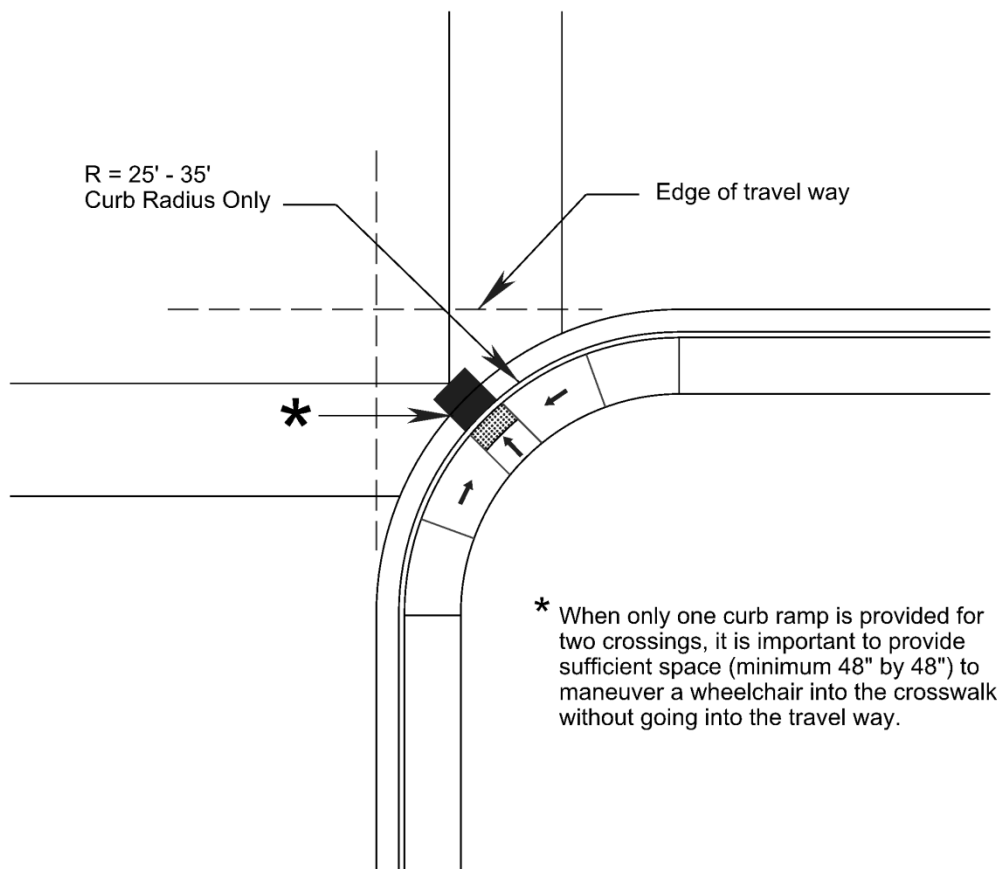
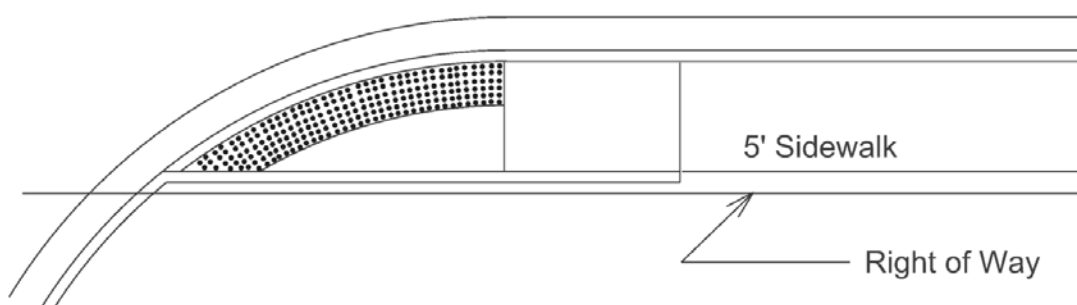

FIGURE A-5-18 SINGLE DIAGONAL PARALLEL CURB RAMP, CG-12, TYPE B

Diagonal curb ramps are **not** recommended for new construction. However, the layout above may be considered for new construction when the curb radius is between 25 and 35 feet only. In alterations, it may be considered when the distance between two CG-12, Type B's is insufficient to install a separate landing for each. This layout shall provide a level landing area or maneuvering space (48" x 48") at the bottom of the ramp and outside of the travelway as shown above.

Note: Diagonal curb ramps force pedestrians descending the ramp to proceed into the intersection before turning to the left or right to cross the street and therefore, make it more difficult for individuals with vision impairments to determine the correct crossing location and direction. Persons with visual impairments may also mistake a diagonal curb ramp for a perpendicular curb ramp and unintentionally travel into the middle of the intersection. Designer should consider the intersection skew when using this layout.

* Rev. 7/14

CG-12, Type B Layout without Buffer Strip***FIGURE A-5-18 TYPE B LAYOUT WITHOUT BUFFER STRIP**

There may be situations where right of way restrictions dictate the above ramp configuration. **It should not be used where right of way or a pedestrian access route continues around the curve.** The bottom of the ramp may be located to the left of the curb return in the above example; however the ramp width shall not be less than 48" at the bottom.

* Rev. 7/14

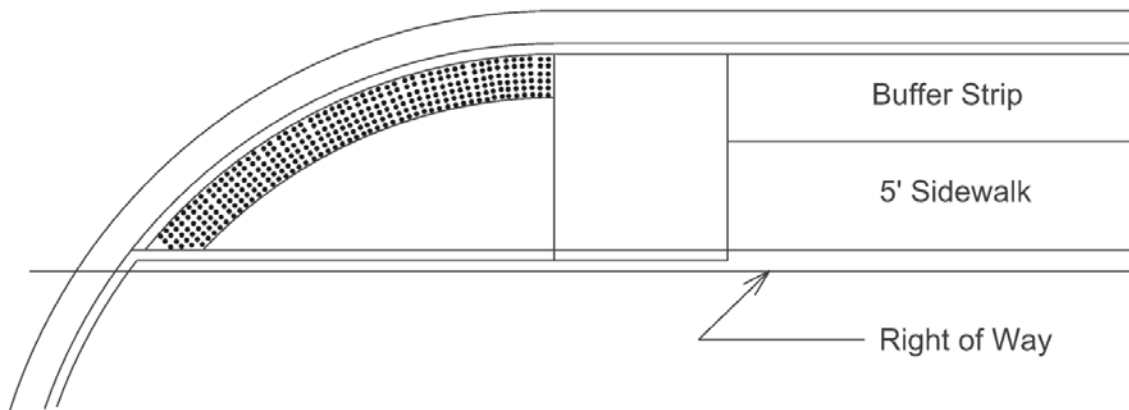
CG-12, Type B Layout, with Buffer Strip***FIGURE A-5-19 CG-12, TYPE B LAYOUT, WITH BUFFER STRIP**

This is similar to Figure 4 except with a buffer strip. **It should not be used where right of way or a pedestrian access route continues around the curve.**

PUBLIC RIGHT OF WAY

Land or property, usually in a corridor, that is acquired for or devoted to transportation purposes.

* Rev. 7/14

BUFFER STRIP

The space provided between the back of curb and the sidewalk to place all lateral obstructions (landscaping, fire hydrants, street lights, parking meters, signal control boxes, signal, sign and utility poles, etc.) to ensure that the pedestrian access route is free of obstacles. When possible, signal poles and signal control boxes should be located behind the sidewalk to minimize conflict with intersection sight distance.

Width

Buffer strips shall be 4 feet wide to provide the lateral offset for the placement of conventional signs (36"x36" wide) for Posted Speeds **greater*** than 25 mph in accordance with the MUTCD, Part 2 (See Detail 1 below). Buffer strips 3 feet wide may be utilized to provide the lateral offset for the placement of smaller signs (24"x24" wide) for Posted Speeds 25 mph and less (See Detail 2 below). **However, a Design Waiver shall be submitted for buffer strips less than 4 feet for Posted Speeds greater than 25 mph and for buffer strips less than 3 feet for Posted Speeds 25 mph or less, See IIM-LD-227.** In unique situations where **no** buffer strip is provided, additional right of way shall be acquired behind the sidewalk for the placement of lateral obstructions (sign, utility poles, landscaping, fire hydrants, street lights, parking meters, signal control boxes, and signal poles, etc.) as well as proposed drainage structures. The Roadway Designer should coordinate with the Traffic Engineering Designer to determine the amount of right of way necessary.

The Roadway Designer has the option to meander sidewalk or construct a wider sidewalk to accommodate the minimum lateral offset for signs while maintaining a minimum clear width of 5 feet for the Pedestrian Access Route.

If trees are to be planted in the buffer strip it shall be a minimum 6 feet wide and the trees should be planted so that the center of the trees are 3 feet minimum behind the back of curb.

* Rev. 7/14

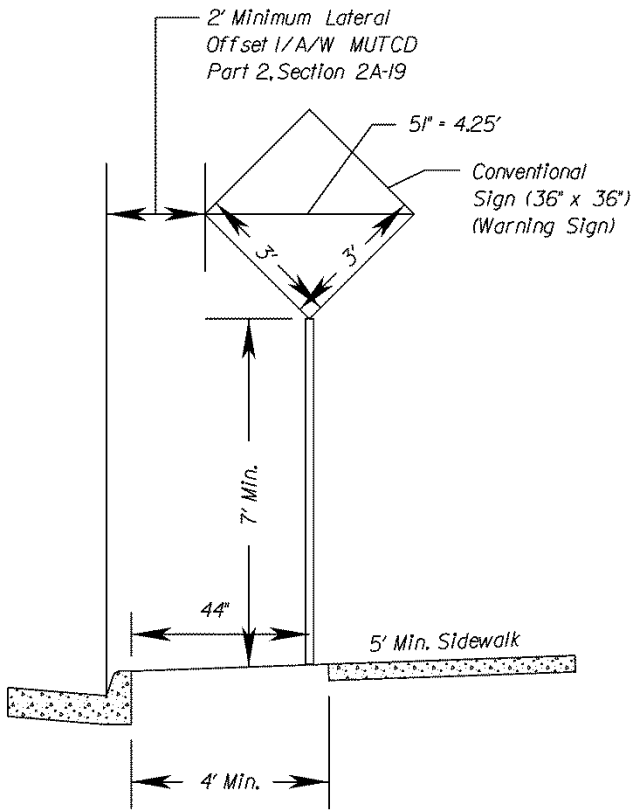

*Typical Urban Projects
Greater than 25 mph
Posted Speed*

DETAIL 1*

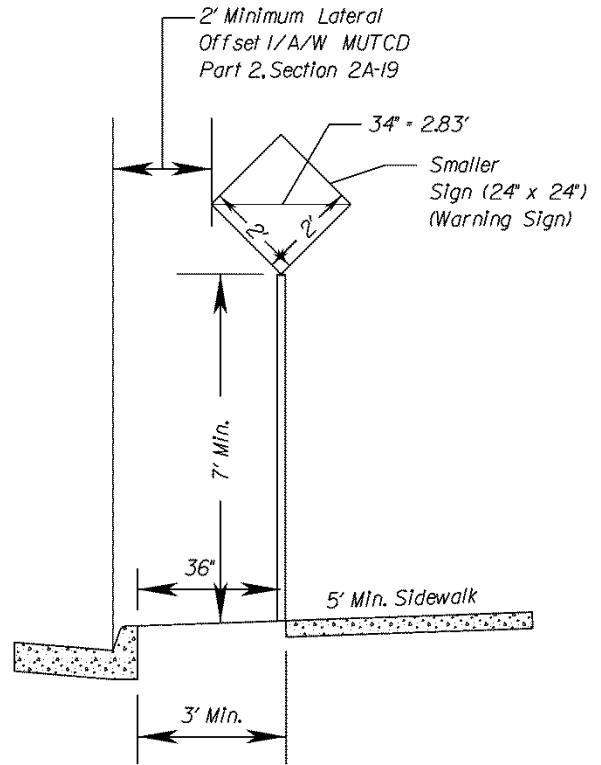

*Subdivision Streets
25 mph Posted Speed
and Less*

DETAIL 2

SIDEWALKS

Sidewalks are that portion of a public right of way between the curb line or lateral line of a roadway and the adjacent property line that is improved for use by pedestrians. Sidewalks shall have the following elements:

* Rev. 7/14

Height Restrictions

The vertical clearance from the sidewalk to the bottom of any sign or over hanging vegetation (Trees) shall be 7 feet minimum in accordance with the [MUTCD](#), Part 2 and AASHTO's Guide for the Planting, Design, and Operation of Pedestrian Facilities, respectively.* Guy wires and utility tie-downs should not be located in or across sidewalks at heights below 8 feet.

The passage along or within a sidewalk should be clear of obstructions underfoot, overhead, or between. Objects with leading edges above the standard sweep of canes (27") from the ground and below the standard head clearance (80") from the ground shall protrude no more than 4" maximum horizontally into the accessible route.

Width

New sidewalks shall be 5 feet wide excluding the width of curb. However, in unique situations where this is not feasible, a minimum clear width of 4 feet shall be provided excluding the width of curb. Pedestrian Access Routes less than 5 feet wide excluding the width of curb require the submission of a Design Waiver (See [IIM-LD-227](#)). **Design Exceptions are not applicable for sidewalks less than 4 feet wide.**

When sidewalk is constructed adjacent to a retaining wall in a "cut" section situation the minimum width shall be 5.5 feet measured from the back of the curb to the face of the retaining wall. However, the recommended minimum width is 6 feet excluding the width of curb. The 6 feet width allows for a 1 foot shy line, rather than a 6 inch shy line from the retaining wall.

New sidewalks less than 5 feet in continuous width excluding the width of curb shall provide a pedestrian passing area a minimum of 5 feet x 5 feet at reasonable intervals not to exceed 200 feet. These passing areas can be provided at driveways and street intersections with cross slopes no greater than 48:1 (2%).

For "NO" on-street parking situations where sidewalk is placed adjacent to the back of curb it shall be 5 feet wide minimum excluding the width of curb and requires the submission of a Design Waiver for No Buffer Strip (See [IIM-LD-227](#)). All lateral obstructions (sign, utility poles landscaping, fire hydrants, street lights, parking meters, signal control boxes, and signal poles, etc.) shall be placed behind the sidewalk so as not to encroach on the pedestrian access route. Therefore, right of way shall be acquired behind the sidewalk for placement of all lateral obstructions.

For on-street parking situations, where sidewalk is placed adjacent to the curb, the width shall be 8 feet wide minimum excluding the width of curb to allow vehicle doors to open and people to exit from the vehicle without blocking the pedestrian access route.

* Rev. 1/16

Grade

Where pedestrian access routes are contained within a street or highway right-of-way, the grade of pedestrian access routes shall not exceed the general grade established for the adjacent street or highway. Where pedestrian access routes are not contained within a street or highway right-of-way, the grade of pedestrian access routes shall be 5 percent maximum.

Slope

Cross slope shall not exceed 48:1 (2%). A level area with minimal cross slope is necessary for accessible passage across a driveway. Driveway aprons constructed like a ramp with steep short side flares can render a section of sidewalk impassible, especially when encountered in series as in residential neighborhoods.

Surfaces

Sidewalk surfaces shall be **stable, firm and slip resistant** and shall be generally in a continuous plane with a minimum of surface warping. "Materials such as gravel, wood chips, or sand, often used for outdoor walkways, are neither firm nor stable, nor can they generally be considered slip-resistant. Thus, these materials do not constitute an accessible route. However, some natural surfaces, such as compacted earth, soil treated with consolidants, or materials stabilized and retained by permanent or temporary geotextiles, gridforms, or similar construction may perform satisfactorily for persons using wheelchairs and walking aids."

Changes in level up to ¼ inch may be vertical and without edge treatment. Changes in level between ¼ inch and ½ inch shall be beveled with a slope no greater than 2:1. Changes in level greater than ½ inch shall be accomplished by means of a ramp.

Where sidewalks cross rail systems at grade, the surface of the pedestrian access route shall be level and flush with the rail top at the outer edge and between the rails.

Grates in sidewalks shall have spaces no greater than ½ inch wide in the direction of traffic flow. If grates have elongated openings, they shall be placed so that the long dimension of the opening is perpendicular to the dominant direction of travel. **All efforts shall be made to avoid grates being located in pedestrian access routes.***

* Rev. 7/15

Sidewalks Along Curb and Gutter Streets

- (1) Sidewalks along curb and gutter streets shall be constructed with hydraulic cement concrete sidewalk or solid paving units.
- (2) Concrete sidewalks shall be constructed in accordance with the Department's specifications for hydraulic cement concrete sidewalk, on a compacted subgrade, and include underdrains in accordance with the Department's Standard UD-3.
- (3) Solid paver unit sidewalks shall be constructed in accordance with VDOT's Location and Design Instructional & Information Memoranda [IIM-LD-218](http://www.virginiadot.org/business/locdes/rd-ii-memoranda-index.asp), Paver Units (Sidewalk and crosswalk), located at <http://www.virginiadot.org/business/locdes/rd-ii-memoranda-index.asp>

Sidewalks Along Shoulder and Ditch Streets

- (1) Sidewalks along shoulder and ditch streets shall be constructed in accordance with VDOT's Road and Bridge Specifications for asphalt concrete sidewalk or hydraulic cement concrete sidewalk, on a compacted subgrade, and include underdrains in accordance with VDOT's Standard UD-3, located at <http://www.virginiadot.org/business/locdes/road-and-bridge-standards.asp>.

Separation – Curb and/or Curb and Gutter Typical Sections*

Sidewalks shall be separated both vertically and horizontally from the adjacent roadway. Vertical separation shall be created through the installation of curbs. Horizontal separation can be achieved through the installation of a buffer strip, landscaping or furniture zones for benches, planters, literature display boxes, or similar clearly defined features or surfaces that will help guide persons who may otherwise unintentionally enter the vehicular way. If horizontal separation is not provided, a Design Waiver shall be submitted in accordance with [IIM-LD-227](http://www.virginiadot.org/business/locdes/road-and-bridge-standards.asp)).

Separation - *Shoulder and Ditch Typical Sections*

Sidewalks constructed along a shoulder and ditch section shall be placed behind the ditch in a manner that will be compatible with the roadway if the roadway is converted to a curb and gutter section. (Note: Placement of sidewalk within the shoulder area is not permitted.)

* Rev. 7/14

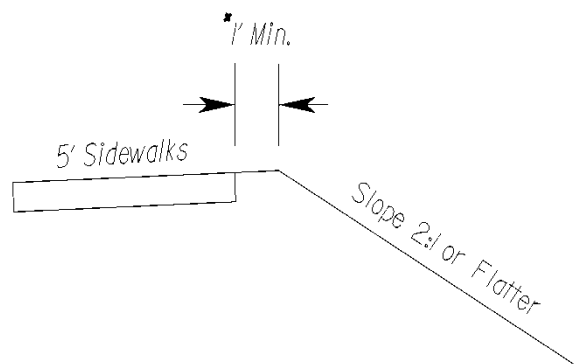

- No railing is required if a 1' min. graded area is provided at the back of sidewalk when the slope is 2:1 or flatter, unless adjacent to a parallel water hazard 2' deep or other obvious hazard. If a railing is required the graded area behind the sidewalk shall be increased by 1' to accommodate the railing. Contact the Location and Design Standards and Special Design Section for details.

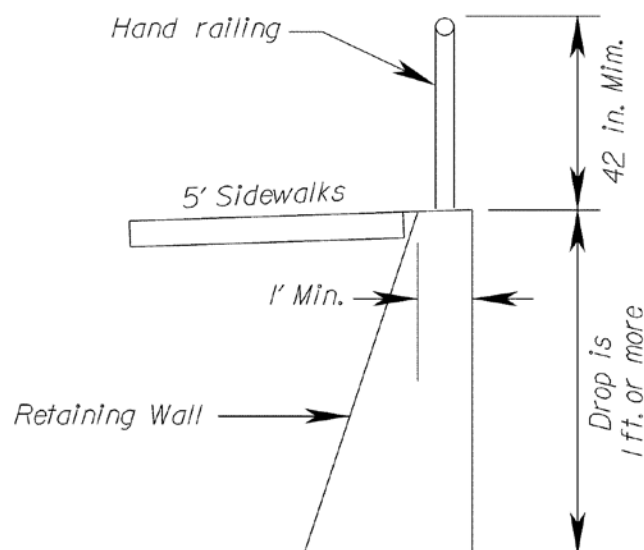

Railing (HR-1 Type II) *is required when sidewalk is constructed adjacent to a vertical drop-off 1' or greater. However, gripping rail is required only when the grade of the sidewalk is 5% or greater. Contact the Location and Design Standards and Special Design Section for details.

* Rev. 1/11

SIDEWALK TRANSITION FROM ROADWAY ONTO BRIDGE

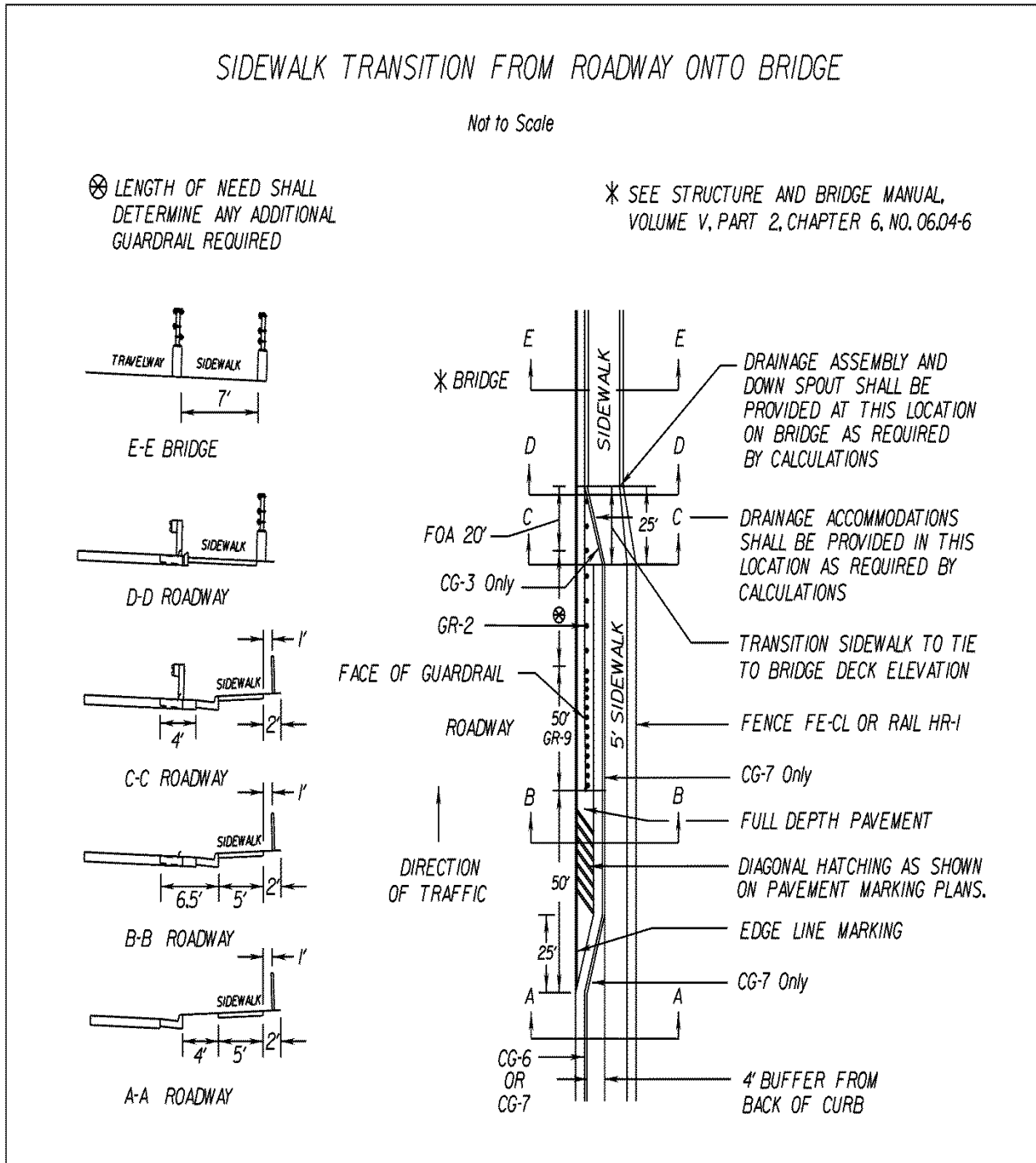

FIGURE A-5-20 SIDEWALK TRANSITION FROM ROADWAY ONTO BRIDGE FOR DESIGN SPEEDS >45 MPH*

* Rev. 1/15

SECTION A-6 AIRPORT CLEARANCE REQUIREMENTS

During the Project Planning Stage, the Designer will determine if there is a potential for substandard airway - highway clearance, or other potential hazard, as determined by the project's location listed below:

1. Within 20,000 feet of public use or military airports with at least one runway greater than 3,200 feet in length.
2. Within 10,000 feet of public use or military airports with runways with a length of 3200 feet or less.
3. Within 5,000 feet of public use, military, or hospital heliports.
4. Any permanent or temporary construction or alteration including any equipment, materials or apparatus that would be more than 200 feet in height above ground level at its site.
5. Construction of wetlands or stormwater management ponds within 5 miles of a public use or military airport.

The Designer will request a review and coordinate notice requirements for any project determined to be within the applicable limits as listed above. A list of airports, as of the printing of these instructions, is provided at the end of this section for assistance in locating applicable airports. The request for review will be made to the Location & Design Airport Clearance Coordinator in the Photogrammetry and Survey Section by Form [LD-252](#).

The Airport Clearance Coordinator will determine current Federal Aviation Administration (FAA) requirements pertaining to the subject project and notify the FAA as early as possible. Part 77 of the Federal Aviation Regulations and the U. S. Department of Transportation FAA Advisory Circular 70/7460-21 contain FAA requirements as of the printing of these instructions.

All evaluations will be determined by using U.S.G.S. or N.G.S. (U.S.C. & G.S.) datum or datum matching quadrangle sheets. In no case will assumed data or local city or town datum be used.

When a new corridor is being developed or an existing corridor is being redeveloped to add lanes, interchanges, etc., the entire corridor is to be reviewed for clearance requirements at a very early stage.

For Final Design, the corridor will probably be divided into multiple projects and be handled by different design sections and/or in a District Office. The establishment of the proposed grade elevations based on the airport clearance requirements at an early stage is important because grade adjustments on a Final Design Project by a section may create major design adjustments on an adjoining project that is being prepared by another section or District Office.

When lighting is required on a project or a possible addition in the future, the pole heights are to be considered in the initial review for clearance requirements. Although a highway may present no problems with vertical clearances, the use of certain types of materials (such as fencing, lighting, etc.) may affect navigational equipment. Also, the use of large construction equipment (such as cranes) may cause encroachment of navigable airspace. Encroachment problems may also result from signs and/or lighting added several years after the roadway completion.

When proposed construction or maintenance activities initiated by other Divisions (i.e. Environmental, Structure and Bridge, Maintenance, Traffic Engineering) or a District Office are within the limits (specified earlier in this section) of airports or heliports, the Location and Design Highway Airport Clearance Coordinator is to be notified by Form [LD-252](#).

When potential clearance conflicts are determined, the designer will contract the Highway Airport Clearance Coordinator via Form [LD-252](#) and request a review. The Designer will submit Form [LD-252](#); one (1) print of the title, typical section(s), and applicable plan and profile sheets for the Highway Airport Clearance Coordinator's review.

The Highway Airport Clearance Coordinator will evaluate the appropriate desirable clearance dimensions between highway surfaces and airway approach zones and, if necessary, request that the designer furnish prints of applicable project plan sheets. This is for early communication between the FHWA, FAA, and the Department and for alerting the FAA of potential hazards to aviation.

When a potential problem exists, FAA Form 7460-1 (notice of proposed construction or alteration), or current form, along with appropriate project review data will be filled by the Highway Airport Clearance Coordinator. A Notice of Construction or Alteration to the Federal Aviation Administrator is required for any proposed construction or alteration. This applies to, but is not limited to, the following:

1. Any object of natural growth or terrain.
2. Permanent or temporary construction or alteration, including equipment or materials used therein, and/or apparatus of a permanent or temporary character.
3. Structures with a change in height (including appurtenances) or lateral dimensions, including equipment or materials used therein.
4. Proposed changes in the land use practices that would attract or sustain hazardous wildlife populations at or near airports.

ASSOCIATED CITY PUBLIC-USE* AIRPORT

| | |
|------------------|--|
| Abingdon | Virginia Highlands Airport |
| Blacksburg | Virginia Tech-Montgomery Executive Airport |
| Blackstone | Allen C. Perkinson Municipal Airport |
| Bridgewater | Bridgewater Air Park |
| Brookneal | Brookneal-Campbell County Airport |
| Bumpass | Lake Anna Airport |
| Charlottesville | Charlottesville-Albemarle Airport |
| Chase City | Chase City Municipal Airport |
| Chesapeake | Chesapeake Regional Airport |
| Clarksville | Marks Municipal Airport |
| Crewe | Crewe Municipal Airport |
| Culpeper | Culpeper Regional Airport |
| Danville | Danville Regional Airport |
| Dublin | New River Valley Airport |
| Emporia | Emporia-Greensville Municipal Airport |
| Farmville | Farmville Regional Airport |
| Forest | New London Airport |
| Franklin | Franklin Municipal Airport |
| Fredericksburg | Shannon Airport |
| Fredericksburg | Stafford Regional Airport |
| Front Royal | Front Royal-Warren County Airport |
| Galax/Hillsville | Twin County Airport |
| Gordonsville | Gordonsville Municipal Airport |
| Grundy | Grundy Municipal Airport |
| Hot Springs | Ingall's Field |
| Jonesville | Lee County Airport |
| Kenbridge | Lunenburg County Airport |
| Lawrenceville | Lawrenceville-Brunswick Municipal Airport |
| Leesburg | Leesburg Executive Airport |
| Louisa | Louisa County Airport |
| Luray | Luray Caverns Airports |
| Lynchburg | Falwell Airport |
| Lynchburg | Lynchburg Regional Airport |
| Manassas | Manassas Regional Airport |
| Marion | Mountain Empire Airport |

-continued-

(continued list of airports)

| <u>ASSOCIATED CITY</u> | <u>PUBLIC-USE AIRPORT</u> |
|-------------------------------|---|
| Martinsville | Blue Ridge Airport |
| Melfa | Accomack County Airport |
| Moneta | Smith Mountain Lake Airport |
| New Market | New Market Airport |
| Newport News | Newport News-Williamsburg International Airport |
| Norfolk | Norfolk International Airport |
| Orange | Orange County Airport |
| Petersburg | Dinwiddie Airport |
| Portsmouth | Hampton Roads Executive Airport |
| Quinton | New Kent County Airport |
| Richland | Tazewell County Airport |
| Richmond | Richmond International Airport |
| Richmond | Chesterfield County Airport |
| Richmond | Hanover County Airport |
| Roanoke | Roanoke Regional Airport |
| Saluda | Hummel Field |
| South Boston | William M. Tuck Airport |
| South Hill | Mecklenburg-Brunswick Regional Airport |
| Staunton | Shenandoah Valley Regional Airport |
| Suffolk | Suffolk Executive Airport |
| Tangier | Tangier Island Airport |
| Tappahannock | Tappahannock-Essex County Airport |
| Wakefield | Wakefield Municipal Airport |
| Warrenton | Warrenton-Fauquier Airport |
| Washington, D.C. | Washington Dulles International Airport |
| Washington, D.C. | Washington National Airport |
| Waynesboro | Eagle's Nest |
| West Point | Middle Peninsula Regional Airport* |
| Williamsburg | Williamsburg - Jamestown Airport |
| Winchester | Winchester Regional Airport |
| Wise | Lonesome Pine Airport |

| <u>Associated Area</u> | <u>Military Airfields</u> |
|-------------------------------|----------------------------------|
|-------------------------------|----------------------------------|

| | |
|--------------|---------------|
| Fort Belvoir | Davidson AAF |
| Fort Eustis | Felker AAF |
| Norfolk | NAS Norfolk |
| Poquoson | Langley |
| Quantico | MCAF Quantico |
| Va. Beach | NAS Oceana |
| | NALF Fentress |

* Rev. 1/08

SECTION A-7-"NO PLAN" AND "MINIMUM PLAN" PROJECTS

GENERAL CONCEPTS

Description

The "No Plan" and "Minimum Plan" concepts provide for the accomplishment by contract of the type improvements that would not require complete and detailed surveys and plans, and where the use of standard Specifications would be appropriate.

Generally, the improvements will consist of widening, grading, draining and stabilizing primary and secondary roads with relatively low traffic volumes by using engineering judgment. Bridge/Structure improvements will consist of drainage structures, "bridge only" rehabilitation and replacement projects with minimal roadway approach work, bridge repair/maintenance and other engineered non-complex structures in nature. These types of projects are to be accomplished by the "Accelerated Bridge Plan" concept as defined in IIM-S&B-84. "No Plan" and "Minimum Plan" concepts are to be used only for projects where significant reductions in the cost/time of engineering, contract development and construction can be experienced by using these concepts to obtain the quality of improvement necessary for the particular situation. To optimize the usefulness of these concepts, very careful initial study and project selection by the District staff is required. The Federal Highway Administration has concurred with the use of the "No Plan" and "Minimum Plan" concepts on selected projects with Federal Oversight.

"No Plan" projects are used when—minimal survey is required to accomplish engineering, right of way and construction stakeout, and no major hydraulic analysis or river mechanics studies are needed. Right of way may be acquired on "No Plan" projects without the preparation of official plans as long as the value of the acquisition of each parcel does not exceed \$5,000. If the anticipated acquisition value is greater than \$5,000 per parcel or eminent domain will be required to acquire property, the information outlined in the Code of Virginia §[33.2-1001](#)* (see below) shall be developed and provided for each parcel on which a certificate is to be filed. A "No Plan" contract contains an assembly of letter size sketches showing the location of the project with a typical cross section and estimated quantities.

"No Plan" road projects and "Accelerated Bridge Plan" projects may be put together in a common contract in the same manner that a minimum plan (M) or construction plan (C) road project is contracted together with a bridge (B) project. When this is done, finished grade control must be provided through the limits of the 500 year flood plain at each bridge or major drainage structure located within the "No Plan" road project that requires a hydraulic analysis. When the contract contains an "Accelerated Bridge Plan" project the structure plans may consist of 8½" X 11" sketches inserted into the assembly or separate full scale bridge plans.

* Rev. 10/14

A "Minimum Plan" project requires survey and topo to provide sufficient right of way plans necessary for the acquisition of right of way by the Right of Way Division and plan, profile and cross section sheets are to be provided. In the establishment of such projects, attention should be given to determine that the project location and selection is in an area where disruption due to construction can be tolerated by the users of that particular roadway for a reasonable period of time.

The "Accelerated Bridge Plan" process may be used with structures requiring "B" or "D" designation numbers and other structures requiring major hydraulic analysis or river mechanics studies, and may also be used for bridge repair/maintenance and other engineered structures when pertinent survey, exploration and engineering are needed. For "Accelerated Bridge Plan" projects, the plan submittal may consist of 8½" X 11" sketches inserted into the assembly or separate full scale bridge plans.

PUBLIC HEARING AND RIGHT OF WAY

All right of way negotiations are to be conducted in accordance with the applicable statutes, regulations, policies, and procedures stipulated in the Right of Way Division's Manual of Instructions and related memoranda.

For "No Plan" projects any required right of way and/or easements will be secured by donation provided no condemnation is requested and no condemnation is required. However, right of way may be purchased without the preparation of official plans as long as the value of the acquisition of each parcel does not exceed \$5,000, which does not include incidental cost, such as fencing, shrubbery, etc. If the anticipated acquisition value is greater than \$5,000 per parcel or eminent domain is required the information as outlined in the Code of Virginia §33.2-1001* (see below) shall be developed and provided for each parcel on which a certificate is filed.

The Code of Virginia §33.2-1001 states the Following:

"If Right of Way is purchased the following information shall be provided: (i) the giving of plans and profile drawings of the project, showing cuts and fills, together with elevations and grades; (ii) explanation, in lay terms, of all proposed changes in profile, elevation and grade of the highway and entrances, including the elevations of proposed pavement and shoulders, both center and edges, with relation to the present pavement, and approximate grade of entrances to the property."

To accompany the plat we need a plan view, profiles of road and entrances and cross sections. The plan area shown should extend about 100 feet on each side of the property to be condemned. If just beyond that is a major feature such as a large drainage pipe, box culvert, SWB, etc. the limits should probably be expanded as it may have some impact on the property value.

* Rev. 10/14

The plan should show the property boundary and all topographic features on the property (within the normal distance into the property) and all existing roadway features. The proposed roadway features (pavement, entrances, drainage, retaining walls, construction limits, guardrail, etc.) should be shown as well as the proposed right of way and easement limits. While not needed for the plans any drainage calculations should be retained in the file.

Right of Way Division will issue a Notice to Proceed on "No Plan" projects when incidental costs, such as fencing, shrubbery, etc. occur. Activity 52 should be added to iPM because of the costs.

The Commonwealth Transportation Board's resolution of February 16, 1961 specifies a minimum 40-foot right of way is to be provided for any initial improvement to the secondary system, except in extenuating circumstances.

Section [33.2-332](#), Code of Virginia permits consideration for hard surfacing of a secondary road on less than a 40-foot right of way.

Right of Way - Donations

An exception to the public hearing requirement will normally be executed on "No Plan" and "Minimum Plan" projects when all landowners are willing to donate the right of way provided there is no evidence of controversy, the landowners have been advised of their right to receive just compensation prior to requesting donations, and the project files have been so documented.

Right of Way - Acquisitions

On "No Plan" and "Minimum Plan" projects when right of way must be acquired, a "Willingness to Hold a Public Hearing" shall be advertised and public hearings shall be conducted upon request. A public hearing handout and appropriate environmental document, on projects with Federal Oversight, will be prepared following the usual guidelines. If there are questions concerning the public hearing requirements or procedures, check with the State Location and Design Engineer.

Right of Way – Certification

Type I certificates are required on all No Plan and Minimum Plan projects with the exception that a Type II certificate may be used if approved by the District Engineer/Administrator or his designee.

SPECIAL DESIGN STRUCTURES, SOIL SURVEY AND PAVEMENT DESIGN

"No Plan" projects may include standard drainage structures or channel modifications that do not require a hydraulic study. Major structures with "B" or "D" designation numbers, major channel modifications or other structures that require a hydraulic study may be constructed under the "Accelerated Bridge Plan" concept. Separate bid items are to be set up when needed.

The District Materials section is to review the project site to determine if soil samples may be necessary. The District Materials Engineer is to furnish recommendations regarding any undercutting or pipe bedding requirements and pavement design.

MOBILIZATION AND FIELD OFFICE

Mobilization is to be set up as a contract item on "No Plan" and "Minimum Plan" projects in accordance with VDOT's Road and Bridge Specifications.

When it is necessary to set up a field office, it is set up as a contract item in accordance with VDOT's Road and Bridge Specifications at the discretion of the District; however, other arrangements should be considered such as the use of existing facilities where feasible to eliminate the need for the extra cost of a field office.

DRAINAGE FACILITIES AND EROSION AND SEDIMENT CONTROL MEASURES

For all land disturbance activities that disturb an area equal to or greater than 10,000 square feet or 2,500 square feet or greater in Tidewater Virginia** an Erosion and Sediment Control (ESC) Plan and a Stormwater Pollution Prevention Plan (SWPPP) must be prepared and included in the contract documents. The appropriate notes on the SWPPP General Sheets must be completed and the SWPPP General Information Sheets must be included in the plan set or other such contract documents. Guidelines for developing and approving an ESC Plan are contained in the latest version of [IIM-LD-11](#). Guidelines for completing the SWPPP General Information Sheets are contained in the latest version of [IIM-LD-246](#).

Temporary and permanent erosion and sediment control measures are required in accordance with the Department's approved ESC and SWM Standards and Specifications. Plan details must accompany any plan narrative and shall denote the type and location of proposed erosion and sediment control measures.

Seeding operations, erosion, and sedimentation control measures shall be included as specific contract items in accordance with standard specifications and procedures. All drainage facilities shall be designed in accordance with the appropriate design criteria noted in the VDOT Drainage Manual and shall comply with Minimum Standard 19 of the Virginia Erosion and Sediment Control Law and Regulations.

** Tidewater, VA, as defined by the Virginia Chesapeake Bay Preservation Act, Title 10.1, Chapter 21, Code of Virginia.

POST CONSTRUCTION STORMWATER MANAGEMENT PLAN AND VSMP CONSTRUCTION PERMIT

For all land disturbance activities that disturb an area equal to or greater than one acre or 2,500 square feet or greater in an area locally designated as a Chesapeake Bay Preservation Area, a post construction stormwater management plan and coverage under the Virginia Stormwater Management Program (VSMP) Construction Permit are required. For routine maintenance activities, the land disturbance threshold is 5 acres (see the latest version of [IIM-LD-242](#) for additional information).

Permanent Stormwater management facilities may be addressed in a similar fashion as the erosion and sediment control facilities provided sufficient detail is included to ensure their proper construction. Any Plan Narrative or details will also become part of the contract assembly. The appropriate notes on the SWPPP General Sheets must be completed and the SWPPP General Information Sheets must be included in the plan set or other such contract documents. Guidelines for developing and approving a post construction SWM Plan are contained in the latest version of [IIM-LD-11](#) and [195](#). Guidelines for completing the SWPPP General Information Sheets are contained in the latest version of [IIM-LD-246](#). Guidelines for applying for VSMP Construction permit coverage are contained in the latest version of [IIM-LD-242](#).

CONTRACT TIME LIMIT

Generally, a fixed contract completion date should be established. However, the contract time limit should be determined after thorough consideration of the need to realize the lowest cost possible to provide the improvement at the earliest practical date.

PROCEDURES

General Description of Work

A general description of the work must be provided on the Project Narrative to denote the nature of the work to be performed, such as daylighting of slopes; realignment; intersection improvement; or widening of shoulders and ditch lines are to be completed by the District ^{*}Engineer/Administrator's Staff. For VDOT advertised projects [Form C-99](#) (No Plan and Minimum Plan Quantity Support Report) should be used. "Simple" sketches may be used in lieu of the narrative. They are to be submitted with the project assembly for the purpose of providing information concerning the general description of construction work from which to develop and support the construction cost estimate.

PROJECT SCOPING FIELD REVIEW

All projects are to be scoped and a Field Review is to be held in accordance with [PM-100](#) these procedures will define the potential need for field and office engineering as well as right of way and environmental requirements.

* Rev. 7/15

"NO PLAN" PROJECTS

The "No Plan" concept may be used when:

- (a) Minimal or no survey is required to accomplish engineering, right of way and construction stakeout.
- (b) Improvements to roadways do not involve major structures with "B" or "D" designation numbers, channel modifications or special design items
- (c) Major hydraulic analysis or river mechanics studies are not required.
- (d) Rights of way are acquired through donations and no condemnation is required.
- (e) Environmental permits including VSMP Construction Permit coverage will not normally be required
- (f) Construction & Plan/Contract Development activities must be handled in an expeditious manner
- (g) Engineering is required

Projects that may be developed with the "No Plan" concept include, but are not limited to:

- (a) Addition of Turn lanes
- (b) Shoulder Widening, Ditch Work, Minor Relocation and Alignment Work
- (c) Intersection Improvements
- (d) Sidewalks and Curb Ramps
- (e) Safety Improvements
- (f) Guardrail Upgrade and Replacement
- (g) Pavement Overlays and Pavement Markers and Markings
- (h) Maintenance Operations
- (i) Sign, Signal and Luminaire Repair and Replacement

"No Plan" projects and "Accelerated Bridge Plan" projects may be combined into the same contract. When the "Accelerated Bridge Plan" project involves a stream/river crossing, finished grade control shall be provided through the 500 year flood plain at each bridge or drainage structure.

District *Engineer/Administrator's Staff normally obtains any donated right of way by use of the appropriate Right of Way Forms. When a "No Plan" project is to be constructed within existing right of way, a note must be placed on the title sheet indicating that "All construction is to be performed within existing right of way."

The construction baseline should generally follow the center of the existing roadway; however, minor relocation and alignment improvements (horizontal and vertical), roadway widening, and turn lanes may be accomplished. The geometrics should comply with the appropriate design standards. However, where it is impractical or not economical to obtain the minimum design and a design exception is required, permission shall be secured from the State Location and Design Engineer and, if applicable, from the State Structure and Bridge Engineer and/or Federal Highway Administration.

The VDOT Project Manager, with the assistance of the project team, determines the typical section and furnishes an estimate of quantities on the "Quantity Support Report" [Form C-99](#). Grading should generally be balanced and set up as a lump sum quantity. [Form C-99](#) should indicate an estimate of grading quantities, including anticipated waste quantities, to guide the Construction Division in preparing the construction cost estimate.

When borrow material is anticipated, "Borrow Excavation" is to be set up as a separate bid item in accordance with VDOT's [Road and Bridge Specifications](#). Borrow sources should be located and designated whenever possible in accordance with VDOT's [Road Design Manual Chapter 2E, Section 2E-1 - SOIL SURVEY AND PAVEMENT DESIGN](#).

A unit price for extra excavation is to be established by the District Administrator's staff and entered on [Form C-99](#) for inclusion in the contract assembly by the contract section.

The Project Manager is responsible for coordinating utility field inspections with the District Staff and preparing the field inspection reports. The District [Engineer/Administrator's Staff](#) is responsible for determining utility conflicts, method of adjustment, cost responsibility and for obtaining and forwarding all plans and estimates from utility owners to the District [Engineer/Administrator](#) (District Utilities Engineer) for approval and authorization. The District [Engineer/Administrator](#) (District Utilities Engineer) will then forward a copy of the approval and authorization letter to the Project Manager to be placed in the project.

The Project Manager or Responsible Charge is also responsible for notifying the District [Engineer/Administrator's Staff](#) (District Utilities Engineer) in writing, no later than 60 days prior to the advertisement of the project, that all arrangements have been made with the utility owners to relocate or adjust the utilities prior to or in conjunction with the project construction.

The Central Office Location and Design, Utilities Section will obtain any necessary FHWA authorization for utility work and will furnish utility clearances and estimates to the Construction Division for contract projects with federal funding. If no known utilities and/or railroads are involved, the plans will contain a note so stating.

The District [Engineer/Administrator's Staff](#) is responsible for the district project funding confirmation for "No Plan" Construction and Maintenance projects and shall sign the "No Plan" Title Sheet. For all other required signatures and Sealing and Signing, see the "No Plan" Title Sheet and Sealing and Signing Sheet, which can be found in Falcon under the eng_ser directory, subfolder for "No Plan".

* Rev. 7/15

The Project Manager or Responsible Change will submit stand alone "Accelerated Bridge Plan" assembly directly to the Construction Division for processing, construction advertisement and applicable federal authorization.

If the proposal and final estimate are developed by the District, the complete contract proposal (including all pertinent Copied Notes and Special Provisions and final estimate) shall be submitted no later than the Advertisement Plan Submission date (column 6 of the "No Plan" advertisement cut-off date chart). Federal criteria sheet shall be included in the submission.

If the proposal and final estimate are to be developed by the Construction Division, the appropriate documentation shall be submitted no later than the Contract Development date (column 2 of the "No Plan" advertisement cut-off date chart). Proposals shall be developed utilizing approved templates.

On Secondary "No Plan" projects, the project manager will submit the plan assembly directly to the Central Office Plan Coordination Section for processing. Plan coordination will forward the plan assembly to the Construction Division for construction advertisement or authorization for State Force work on projects with Federal Oversight, whichever is applicable.

Primary "No Plan" projects will continue to be submitted to the Central Office Plan Coordination Section for processing and approval for advertisement (See IIM-68 for Electronic Plan Submission). Construction plans will be retained in the District until right of way has been secured and arrangements made for utility adjustments. When retained, status reports (containing applicable correspondence) will be submitted by the District Engineer/Administrator's staff quarterly until all right of way is acquired and utilities are clear.

"MINIMUM PLAN" PROJECTS

A "Minimum Plan" project requires survey and topo to provide sufficient right of way plans necessary for the acquisition of right of way by the Right of Way Division and plan, profile and cross section sheets are to be provided. In the establishment of such projects, attention should be given to determine that the project location and selection is in an area where disruption due to construction can be tolerated by the users of that particular roadway for a reasonable period of time.

Those projects that require an engineering design should be designated as "Minimum Plan" projects. This will provide the mechanism for the development of required engineering studies and will provide a vehicle for transmitting critical information to the contractor.

Projects that should be developed with the "Minimum Plan" concept include, but are not limited to:

- (a) Projects requiring more than minimal survey
- (b) Major stream crossing sites
- (c) Projects that will require environmental evaluation and/or permits
- (d) Projects requiring major hydraulic analysis or river mechanics studies
- (e) Projects that involve the acquisition of right of way and/or condemnation

The basic difference between the "Minimum Plan" and the "No Plan" project is the need for more than minimal survey and topo to provide sufficient right of way plans necessary to acquire right of way. Form RW-205 or individual deed forms are to be used. If any additional right of way or easements are necessary, the right of way certificate and release for advertisement will be required. If additional right of way or easements are not required, the "Minimum Plan" title sheet is to contain a note indicating that "All construction is to be performed within existing right of way."

"Minimum Plan" projects may include relocation or alignment improvements (horizontal or vertical), roadway widening, and the addition of turn lanes that involve the acquisition of right of way and/or condemnations.

A general description of work must be provided on [Form C-99](#) and the Field Narrative to denote additional work that is not covered on the plans.

Special attention should be given to major drainage sites and the limits set for the proposed right of way. The geometrics should comply with the appropriate design standards. However, where it is impractical or not economical to obtain minimum design standard an design exception is required, permission must be secured from the State Location and Design Engineer and, if applicable, from the Federal Highway Administration.

Quantities, typical sections, entrance profiles and other similar information should be shown on the initial plan and profile sheets. A grade line is required when the grade is to be different than that of the existing road. In areas where right of way is to be obtained and entrance grading is necessary, a profile showing the approximate grade of the proposed entrance should be included in the plan assembly.

When borrow material is anticipated, "Borrow Excavation" is to be set up as a separate bid item in accordance with Section 303 of VDOT's [Road and Bridge Specifications](#). Borrow sources should be located and designated, whenever possible, in accordance with VDOT's [Road Design Manual](#), [Chapter 2E](#), [Section 2E-1](#) - SOIL SURVEY AND PAVEMENT DESIGN.

A unit price for extra excavation is to be established by the District Construction Engineer or the District ^{*}Engineer/Administrator's staff and entered on [Form C-99](#) for inclusion in the contract assembly by the contract section.

The Project Manager is responsible for coordinating utility field inspections with the District ^{*}Engineer/Administrator (District Utilities Engineer) and preparing the field inspection reports. Utility adjustments shall be handled in accordance with [IIM-LD-140](#) and Road Design Manual, Chapters 2E and 2G, which can be accessed at <http://www.virginiadot.org/business/locdes/rdmanual-index.asp>

* Rev. 7/15

For all land disturbance activities that disturb an area equal to or greater than 10,000 square feet or 2,500 square feet or greater in the area defined as Tidewater Virginia**, an Erosion and Sediment Control Plan and a Stormwater Pollution Prevention Plan (SWPPP) must be developed, reviewed, and approved by appropriate qualified personnel in accordance with the latest version of [IIM-LD-11](#) and [IIM-LD-246](#).

** Tidewater, VA, as defined by the Virginia Chesapeake Bay Preservation Act, Title 10.1, Chapter 21, Code of Virginia.

For all land disturbance activities that disturb one acre of land or greater or 2,500 square feet or greater in an area locally designated as a Chesapeake Bay Preservation Area, a Stormwater Management Plan must be developed, reviewed, and approved by appropriate qualified personnel in accordance with the latest version of [IIM-LD-11](#) and [IIM-LD-195](#).

PERMITS AND REVIEWS ("NO PLAN" AND "MINIMUM PLAN" PROJECTS)

Historical and archaeological reviews are to be made. (Request Forms [LD-252](#) and [EQ-429](#)). The need for 401, 404, navigation, and other environmental permits are to be considered in accordance with the Guidelines for the Preparation of Permit Application. Any land disturbing activity that disturbs one acre or greater (or 2,500 square feet or greater in an area locally designated as a Chesapeake Bay Preservation Area, (except certain routine maintenance activities specifically exempted by the Virginia Stormwater Management Law and the Virginia Stormwater Management Program (VSMP) Permit Regulations - 4VAC50-30 et seq. and 4VAC50-60 et seq.) must have a project specific VSMP Construction Permit registration. Instructions for registering a project for VSMP Construction Permit coverage are contained in [IIM-LD-242](#). (Request Form [LD-445](#), [445A](#), [445B](#) and [445C](#))

PLAN PREPARATION

The sample plan assemblies for both "No Plan" and "Minimum Plan" projects provide the manner of showing the minimum essential information and the notes necessary to govern construction. For the current version of the "No Plan" title sheet, see the CADD No Plan Directory, which is in Falcon under Engineering Services (eng-ser).

"Minimum Plan" title sheet shall include all the information as that shown on a "Construction Plan" title sheet. Variation may be made to the formats to meet the specific project needs and to best utilize all available sheet space, thereby minimizing the total number of project assembly sheets. Careful attention should be given to the notes shown thereon.

The Contractor shall perform all construction surveying on "No Plan" and "Minimum Plan" projects in accordance with the Special Provision "Copied Note" for Section 105.10 of VDOT's [Road and Bridge Specifications](#). (See VDOT [Survey Manual](#), Chapter 8).*

* Rev. 1/15

The plan assemblies for both “No Plan” and “Minimum Plan” projects are to be placed in Falcon and transmitted electronically. The document assembly instructions are located in Falcon along with the other typical drawings needed for “No Plan” and “Minimum Plan” projects.

Generally, plan variations from AASHTO guidelines, as set forth in the Geometric Design Standards (See VDOT's [Road Design Manual](#), Appendix A), are not readily apparent in an Reassembly (consisting of the plan details, [Form C-99](#), cost analysis, and narrative or description of the work) by the VDOT Project Manager and/or District [Engineer/Administrator](#).

When “Minimum Plan” roadway projects are combined with “Accelerated Bridge Plan” projects, the proposal and final estimate will be developed by the Construction Division.

SPECIFICATIONS

It is intended that modified versions of parts of VDOT's [Road and Bridge Specifications](#) will be followed in order to reduce the field engineering and final computations required; however, the use of such modifications must still be consistent with good construction practices in relation to the kind and type of improvement being provided and must comply with the Department's Approved Erosion and Sediment Control and Stormwater Management Standards and Specifications and the Virginia Stormwater Management Program Laws and Regulations.

A unit price for extra excavation is to be established by the District Construction Engineer or the District [Engineer/Administrator](#)'s staff and entered on Form C-99 for inclusion in the contract assembly by the contract section.

The Special Provisions for "No Plan" and "Minimum Plan" Projects (available from VDOT's Construction Division) are approved by the Federal Highway Administration for use on a project by project basis. When additional changes to the Specifications are necessary, such changes should be documented and submitted with the project assembly. Any additional Special Provisions are to be reviewed by the Construction Division in ample time for inclusion in the project bid proposal.

Generally, materials from sources that have proven to be satisfactory in the past will normally be accepted by certification as determined by VDOT's Materials Division, subject to visual inspection at the project site.

The Contractor shall perform all construction surveying on "No Plan" and "Minimum Plan" projects in accordance with the Special Provision "Copied Note" for Section 105.10 of VDOT's [Road and Bridge Specifications](#). (See VDOT [Survey Manual](#), Chapter 8).

* Rev. 7/15

Prospective bidders may be required to attend the Project Showing as a prerequisite for submitting a bid proposal for "No Plan" and "Minimum Plan" projects. When attendance is required, prospective bidders must register with the Engineer at the project showing and all attending parties are to be noted in the project showing letter. The Area Construction Engineer or Construction Manager and the Project Inspector must also attend the project showing. The Field Narrative will indicate if attendance is required.

PROJECT LAYOUT

If deemed necessary by the District **Engineer/Administrator** or District Construction Engineer, marked stakes shall be established showing the approximate depth at centerline of major fills and cuts which exceed 4 feet and/or other areas as required. Marked stakes shall be in place at the time of the Project Showing.

Survey work for "Minimum Plan" projects should normally be performed in accordance with the VDOT Survey Instructions Manual or as otherwise determined by the District **Engineer/Administrator** or District Construction Engineer. The designer should determine in the early stages of the plan development where additional survey is needed in order to alleviate any major problem during construction. For entrance profiles on "Minimum Plan" projects see [Appendix "F" – Section 4 – Entrances Affected by Highway Construction Projects](#).

INSPECTION AND RECORD KEEPING

Close coordination between the Project Inspector and the Contractor is necessary to assure the success of the "No Plan" and "Minimum Plan" concepts.

One loose leaf notebook is normally necessary on a "No Plan" or "Minimum Plan" project for use as a combination diary, materials book, and sketch book provided that electronic versions of these materials are not available.

Alignment and sketches may be entered in accordance with standard procedures or, where feasible, small sketches may be glued into the notebook to properly indicate the work performed.

Where it is determined by the District that "As Built Plans" are more practical, they may be used in lieu of entering alignment, sketches, and summaries in the notebook. When "As Built Plans" are used, any changes, additions, or deletions of any nature are to be clearly indicated on the prints/files furnished to the Inspector with the diary and materials information entered in the notebook.

All documents pertaining to the SWPPP for the project shall be kept in an individual notebook or folder and shall be available for review upon request during normal working business hours (See [IIM-LD-246](#)).

Upon the completion of a project, all records shall be submitted in accordance with standard procedures; except that after verification of the materials section by the District Materials Engineer, a reproducible copy of the materials section of the notebook/file is to be furnished to the State Materials Engineer in lieu of furnishing the original document/file.

**NO PLAN PROJECT
COMMONWEALTH OF VIRGINIA
DEPARTMENT OF TRANSPORTATION**

DISTRICT:
Bristol

COUNTY:
Buchanan

PPMS NO:
58266

FUNCTIONAL CLASS
Rural Local

FHWA 534 DATA

TYPE CODE
I000

ROUTE: 628

PROJ. 0628-013-P56, N501

FEDERAL AID:

FROM: 0.67 Mi. S. Rte. 638

TO: 0.17 Mi. S. Rte. 638

LENGTH: 2640 Ft.

0.50 Miles

TOPO: Mnts.

DES. SPEED: 20 MPH

200 VPD (2001)

DESIGNED BY: R. L. Musser

R/W DONATION: Yes

Utilities No and/or Railroads No are involved in the construction of this project.

This project is to be constructed in accordance with the Department's Road and Bridge Specifications dated 2007*, Road and Bridge Standards dated December, 2008, Work Area Protection Manual dated May 2005 and as amended by contract provisions and the complete plan assembly.

"All curves are to be superelevated, transitioned and widened in accordance with proper highway engineering practices."

NOTE: THESE PLANS WERE DESIGNED IN ACCORDANCE WITH VIRGINIA RRR GUIDELINES.

| RECOMMENDED FOR APPROVAL FOR CONSTRUCTION | |
|---|-------------------------------|
| DATE | DISTRICT ADMINISTRATOR |
| DATE | PROGRAMMING DIVISION DIRECTOR |
| DATE | CHIEF FINANCIAL OFFICER |
| APPROVED FOR CONSTRUCTION | |
| DATE | CHIEF ENGINEER |

Copyright 2003 Commonwealth of Virginia

PROJECT LOCATION MAP

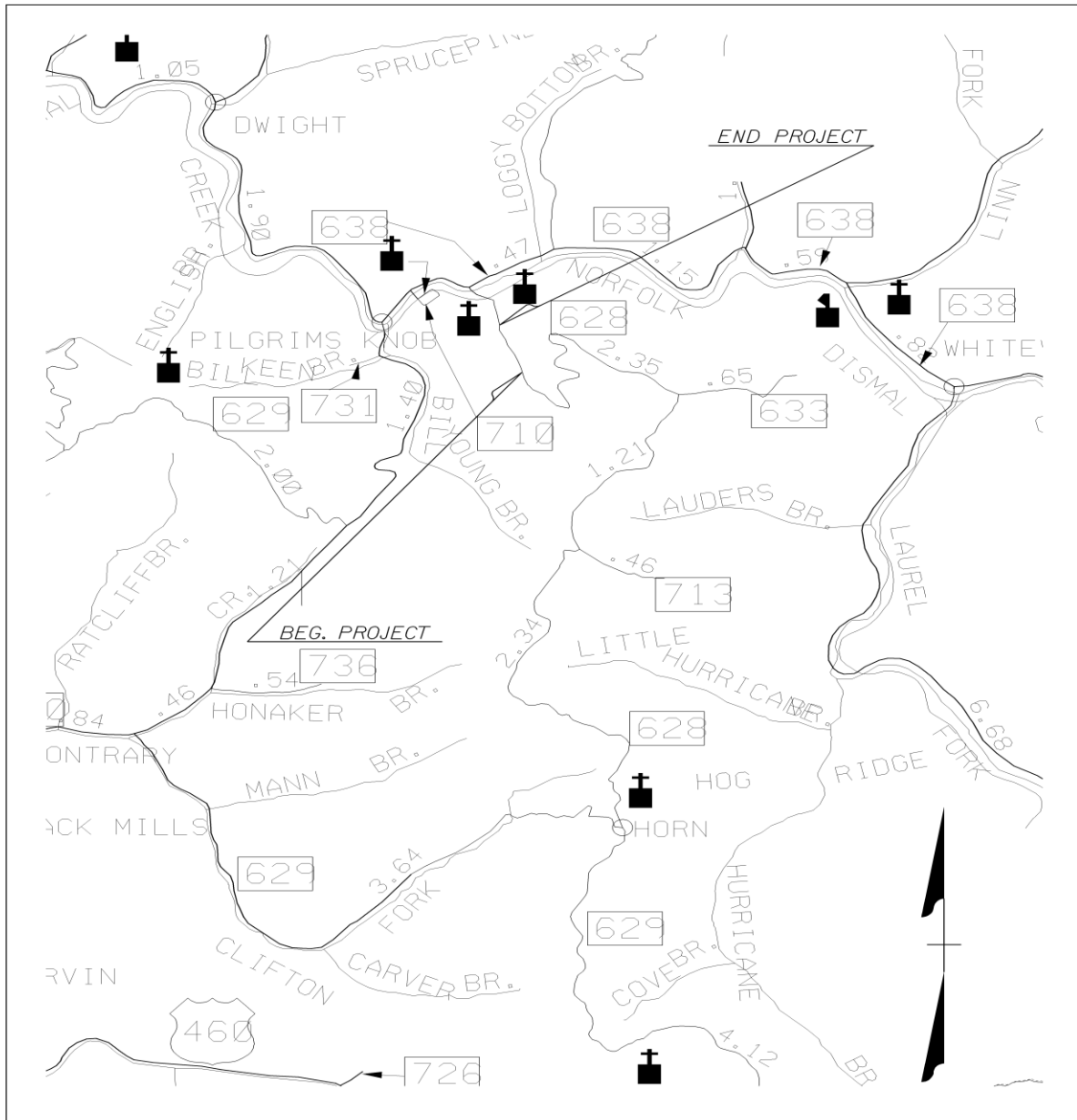

0628-013-P56, N501

ROUTE 628, BUCHANAN COUNTY*

* Rev. 1/07

TYPICAL SECTION

0628-013-P56, N501

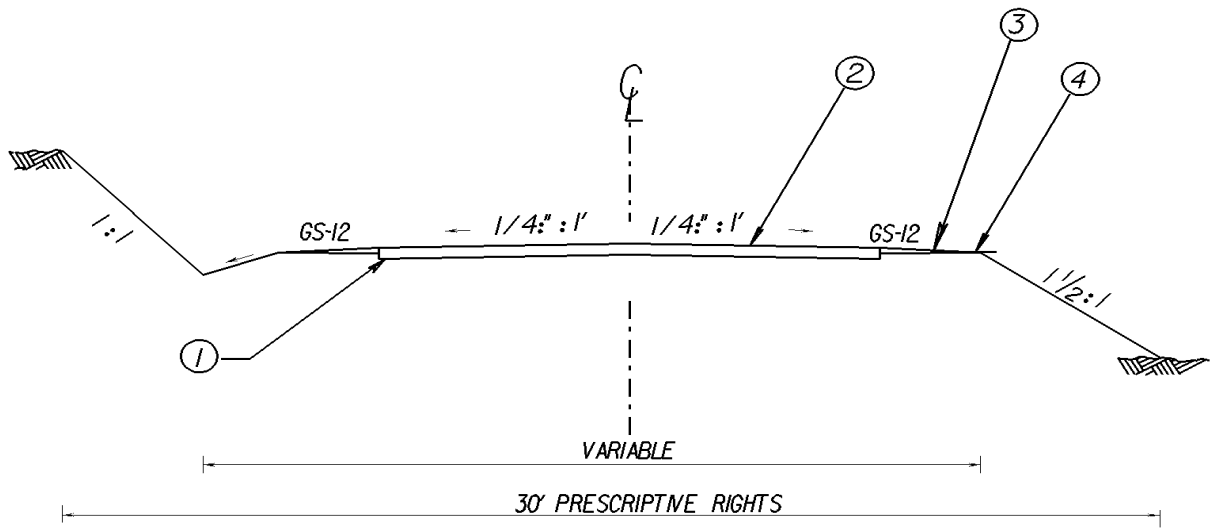

*** R/W WITH EASEMENTS FOR CUTS AND FILLS**

NOT TO SCALE

- ① 6" DEPTH AGGR. BASE MATL. TY. 1 NO. 21B
- ② 4" DEPTH ASPHALT CONC. TY. BM-25.0
- ③ ASPHALT CONCRETE TY. SM-19.0 A AT RATE OF 200 LBS. SQ. YD.
- ④ STABILIZE SHOULDERS WITH 2" OF AGGR. BASE MATL. TY. 1 NO. 21B FOR ENTIRE WIDTH OF SHOULDERS

Note: Depth to be placed as directed by the Engineer.

R/W WITH EASEMENTS FOR CUTS AND FILLS

6" Depth to be used for Estimating Purposes ONLY.

Increase shoulder width to 5' where guardrail is required.

General Notes

- **Mainline and entrance pipes are to be concrete and paid for per linear feet.**
- **Aggregate material No. 21 or 21B and Aggregate Base Material No. 1 is to be used to stabilize roadway and is to be paid for on a tonnage basis.**
- **Aggregate Material No. 25 or 26 is to be used to maintain roadway and entrances and is to be paid for on a tonnage basis.**
- **Erosion Control Stone Class I, EC-1 is to be used for erosion control at pipe outlets and where deemed necessary to prevent erosion and is to be paid for on a tonnage basis.**
- **Clearing and Grubbing is to be performed where necessary to construct the typical section and in accordance with Section 301 of the Specifications.**
- **Height of cover for pipe culverts is minimum unless otherwise designated.**
- **The locations and lengths of all drainage structures shown in this assembly are approximate only. Contractor shall verify locations and lengths of all drainage structures with Engineer prior to installation of drainage structures.***

* Rev. 1/07

Erosion & Sediment Control Narrative

Project 0628-013-P56, N501 is a Rural Rustic Road project located off of Route 638 approximately 0.17 miles south of Rte. 638. Drainage from the project will flow to Burnt Chestnut Br. a tributary of Dismal Creek. The following erosion and sediment control measures are proposed to control runoff from the site.

- The project will consist of paving 0.50 miles of non-hard surfaced roadway, establishing ditch lines, replacing cross pipes.
- All perimeter controls shall be installed prior to upslope disturbances.
- Temporary filter barrier or temporary silt fence shall be utilized at the toe of proposed fill slopes. Temporary filter barrier may be utilized for slope heights less than 5 feet. Temporary silt fence is required when slope heights are equal to or greater than 5 feet.
- Type II Rock Check Dams shall be utilized in cut ditch lines, and as inlet protection for cross drains and entrance pipes. If the drainage cannot be controlled within the ditch line, then temporary filter barrier shall be installed on the out slope shoulder.
- EC-1 Class I erosion control stone shall be installed for outlet protection on ALL pipes, unless otherwise noted on the SLS.
- The project shall be stabilized in accordance with VDOT Specification 303.03(b).
- All E&S controls shall be removed within 30 days after the project has been stabilized.
- Installation of culverts in live streams shall be done in accordance with the attached VDOT memorandum regarding replacement of pipes in live streams.

The following standards are hereby incorporated as part of this erosion & sediment control plan:

- Std. EC-1: Stone for Erosion Control (VA Rd. & Bridge. Standards).
- Std. EC-4: Rock Check Dams Type I & II (VA Rd. & Bridge. Standards).*

* Rev. 1/07

FIELD NARRATIVE

- Pave with Asphalt Concrete Ty. BM-25.0 at 4" depth then surface with Asphalt Concrete Ty. Sm-19.0A at 200 lbs./s.y.
- No cut or fill sections.
- The roadway typical section is to be constructed the entire length of the project.
- Pipe shall be paid for at the contract price per linear foot. This price shall include excavating, when not a pay item, sheeting, shoring, cofferdams and dewatering basins (see SPECS. 302.04). Ditches with running water shall be treated as live streams.
- Clearing and grubbing is to be performed where necessary the entire length of the project in accordance to right of way widths, cuts, and fills as per typical section and Section 301 of the 2007* Road and Bridge Specifications.
- Temporary filter barriers and temporary silt fences will be required along toe of fills.
- Rock check dams will be required in ditch lines.
- All pipes that are placed in jurisdictional waters must be countersunk. Pipes 24" or smaller are to be countersunk 3". All pipes greater than 24" are to be countersunk 6".
- There are live streams on this project and it has been determined that Stormwater Management Facilities are not required for this project.
- This project is to be constructed on existing 30' prescriptive rights.

GENERAL PERMIT NO: DCR01

PROJECT ID: 58266

EFFECTIVE DATE:

TGT ADV DATE: 12/07

EXPIRATION DATE: JUNE 30, 2009

STATE PROJ NO: 0628-013-P56,N501

* Rev. 7/09

Erosion & Sediment Control Plan Narrative

PROJECT DESCRIPTION

Grade, drain and pave existing 16' stabilized roadway to a typical section of 18' paved with 2' shoulders and a 3' ditch. All work to be performed on the existing alignment. Pipes will be replaced on this project. Rip Rap will be placed at the outlet of all pipes. This is a Rural Rustic project and will be constructed on the existing 30' right of way.

PROJECT LOCATION

The project is located from 0.67 Mi. S. Route 638 at Latitude 37° 14' 10" (NAD27), to 0.17 Mi. S. Route 638 at Longitude 81° 54' 04" (NAD27), on the Keen Mtn. USGS 7.5 minute topographic quadrangle map.

PROJECT AREA

Project Right-of-Way Area: 30'
Expected Area To Be Disturbed: 1.82 acres

EXISTING SITE CONDITIONS

The existing project vegetative cover consists of brush and trees. The existing topography consists of mountainous terrain. The existing drainage patterns consist of Ditches effluent into Burnt Chestnut Br. in a northern direction and tributates Dismal Creek..

Soils located within the project limits consist of the following types:

- *****
- *****
- *****

Runoff from the project will discharge to: Burnt Chestnut Br.

Adjacent Areas

Areas adjacent to the project include: Mountainous terrain

Critical Areas

Critical areas on the project consist of: none

Stormwater runoff considerations for this project include: EC-1 (Erosion Control Stone), Rock Check Dams and Temporary Silt Fence/Filter Barrier*

* Rev. 1/07

Erosion & Sediment Control Measures

The erosion and sediment control measures shown on the Straight Line Sketch (SLS) for this project can be seen in further detail in the VDOT Road & Bridge Standards, 2008* Edition. These controls are consistent with the requirements of the Virginia Erosion and Sediment Control Handbook, 1992 Edition.

The following E&S measures will be used to control runoff on this project:

- St'd. EC-1 (Erosion Control Stone)
- St'd. EC-4 (Rock Check Dam)
- St'd. EC-5 (Temporary Silt Fence / Filter Barrier)
- Culvert Inlet Protection
- *****
- *****

All erosion and sediment controls are to be installed, inspected, maintained, and removed in accordance with VDOT Specifications and Standards. Runoff from the cut slope shall be maintained in an established ditch, and controlled with the measures shown on the SLS. If conditions exist where an established ditch cannot be maintained, runoff may be controlled, if approved by the Engineer or the Environmental Monitor, with either Temporary Silt Fence (TSF) or Temporary Filter Barrier (TFB) positioned on the roadway fill side. If runoff from the cut side is controlled on the fill side with TSF or TFB, the existing roadway is to be stabilized with maintenance stone as required.

Site stabilization will be conducted in accordance with VDOT Specification 303.03(b), the Roadside Development Sheet, and all other measures shown on the Straight Line Sketch (SLS).

The Contractor is responsible for complying with both VDOT Specifications 106.03 and 106.04 for all off-site support facilities.

CONTACT INFORMATION

VDOT (Bristol District Office)
 Location & Design – Hydraulics Section
 870 Bonham Road
 P.O. Box 1768
 Bristol, VA 24203

* Rev. 7/09

SUMMARY NOTES

(Construction Items)

| Item | Unit | Quantity | Item | Unit | Quantity |
|--------------------------------------|------|----------|----------------------------------|------|----------|
| Mobilization | LS | 1 | Group 2 Channelizing Devices | Day | 50 |
| Grading | LS | 1 | Flagger Service | Hr. | 1,800 |
| 18" Conc. Pipe | L.F. | 160 | Warning Light TY. A | Day | 25 |
| Erosion Control Stone Cl. I, EC-1 | Ton | 12 | Regular Seed | Lb. | 300 |
| Aggr. NO. 1 | Ton | 100 | Over Seeding | Lb. | 300 |
| Aggr. Base Mat'l. Ty. I No. 21B | Ton | 2,058 | Legume Seed | Lb. | 40 |
| Asphalt Concrete Ty. SM-19.0A | Ton | 528 | Legume Overseeding | Lb. | 40 |
| Allaying Dust | Hr. | 50 | Fertilizer (15-30-15) | Ton | 1 |
| Construction Signs | S.F. | 144 | Lime | Ton | 4 |
| Cr. Run Aggr. No. 25 or 26 | Ton | 500 | Check Dam (Rock) Ty. II | Ea. | 20 |
| Temp. Filter Barrier | L.F. | 2640 | Siltration Control Excavation | C.Y. | 472 |
| | | | Temp. Silt Fence | L.F. | 100 |
| | | | | | |
| | | | | | |
| | | | | | |
| | | | | | |
| | | | | | |
| | | | | | |
| | | | | | |

Denotes item(s) to be paid for on basis of plan quantities in accordance with current Road and Bridge Specifications.*

* Rev. 1/07















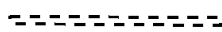

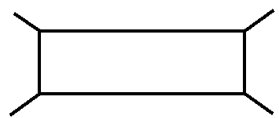
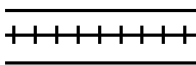

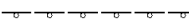

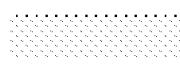
Erosion And Sediment Control Plan

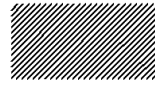
Straight Line Sketch Notes

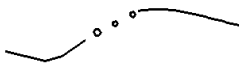
- All Pipes and culverts must be installed in the dry
- All E & S controls need to be removed within 30 days after project is stabilized (MS 18)
- All referenced standards and E & S controls should conform to the latest edition of the VDOT Road and Bridge Standards.
- Refer to contract documents for all quantities (E.G. minor Structure excavation, bedding backfill, etc.)
- For additional guidance on E & S controls, refer to IIM-LD-11.24*
- Dewatering devices may be required at live stream pipe installation.
- All disturbed areas will be stabilized with seed and mulch in accordance with the Roadside Development Sheet.

* Rev. 7/09

LEGEND

| | | | |
|---|--------------------------------|--|-----------------------------|
|  | STD. PE-1 ENTR. REQ'D. |  | CHURCH |
|  | ENTRANCE PIPE |  | BARN |
|  | PIPE |  | HOUSE |
|  | BOX CULVERT |  | RAILROAD CROSSING |
|  | EC |  | Gurdrai |
|  | DRAINAGE FLOW ARROW |  | MAINLINE CUT |
|  | CUT/FILL |  | MAINLINE FILL |
|  | ROCK CHECK DAM |  | TEMP. SILT FENCE |
|  | STREAM OR EDGE OF WATER |  | TEMP. FILTER BARRIER |
|  | POND |  | TREE |
|  | Wet Land |  | CEMETERY |

NOT TO SCALE

*

RTE.628, BUCHANAN COUNTY

FR: 0.67 MI. S. RTE.638
TO: 0.17 MI S. RTE. 638

STA. 7 + 44
(EXIST. 18" IN PL.
DO NOT DISTURB)

STA. 1+75
40' - 18" PIPE (CONC)
(EXIST. 18" IN PL.
TO BE REPLACED)

STA. 0+37
EXIST. 15" PIPE
DO NOT DISTURB

STA. 0 + 00
BEGIN PROJECT
BEGIN GRADING

- * ALL LOCATIONS ARE APPROXIMATE AND ARE SUBJECT TO CHANGE BY ENGINEER
- * NOT TO SCALE

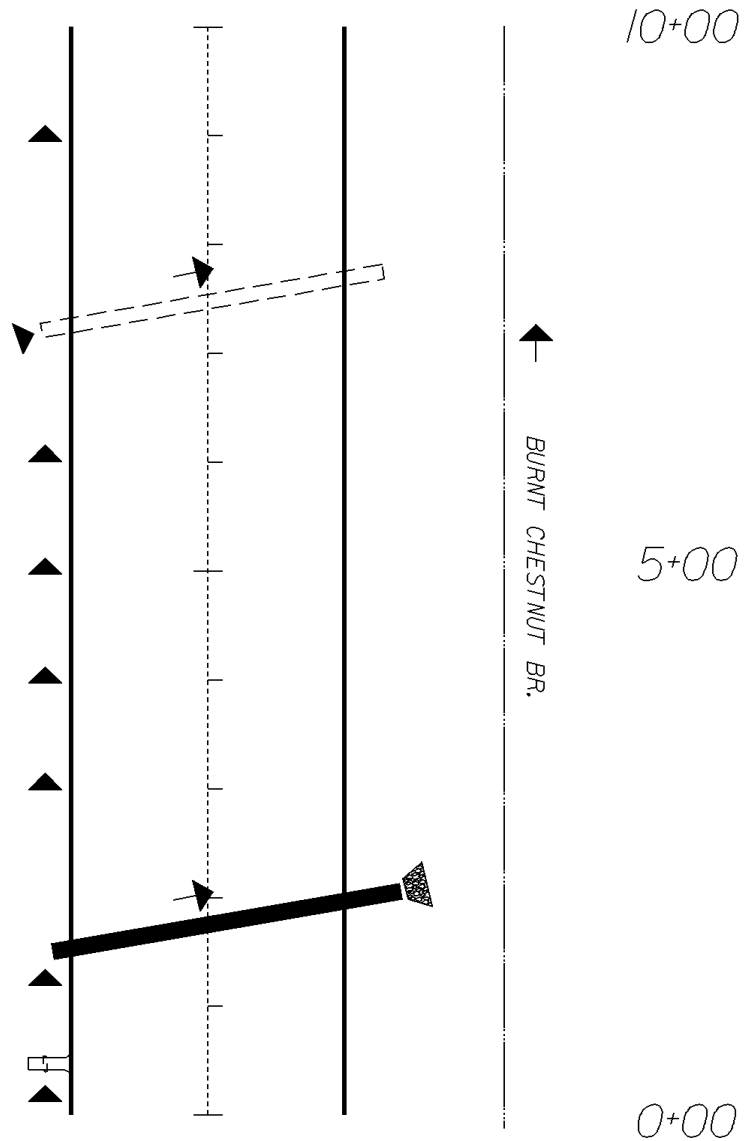

*

RTE. 628, BUCHANAN COUNTY

FR: 0.67 MI. S. RTE. 638
TO: 0.17 MI S. RTE. 638

STA. 19+91
(EXIST. 42" X 72" IN PL.
DO NOT DISTURB)

STA. 19+69
(EXIST. 15" IN PL.
DO NOT DISTURB)

STA. 17+72
(EXIST. 24" IN PL.
DO NOT DISTURB)

STA. 12+44
40' - 18" PIPE (CONC)
(EXIST. 18" IN PL.
TO BE REPLACED)

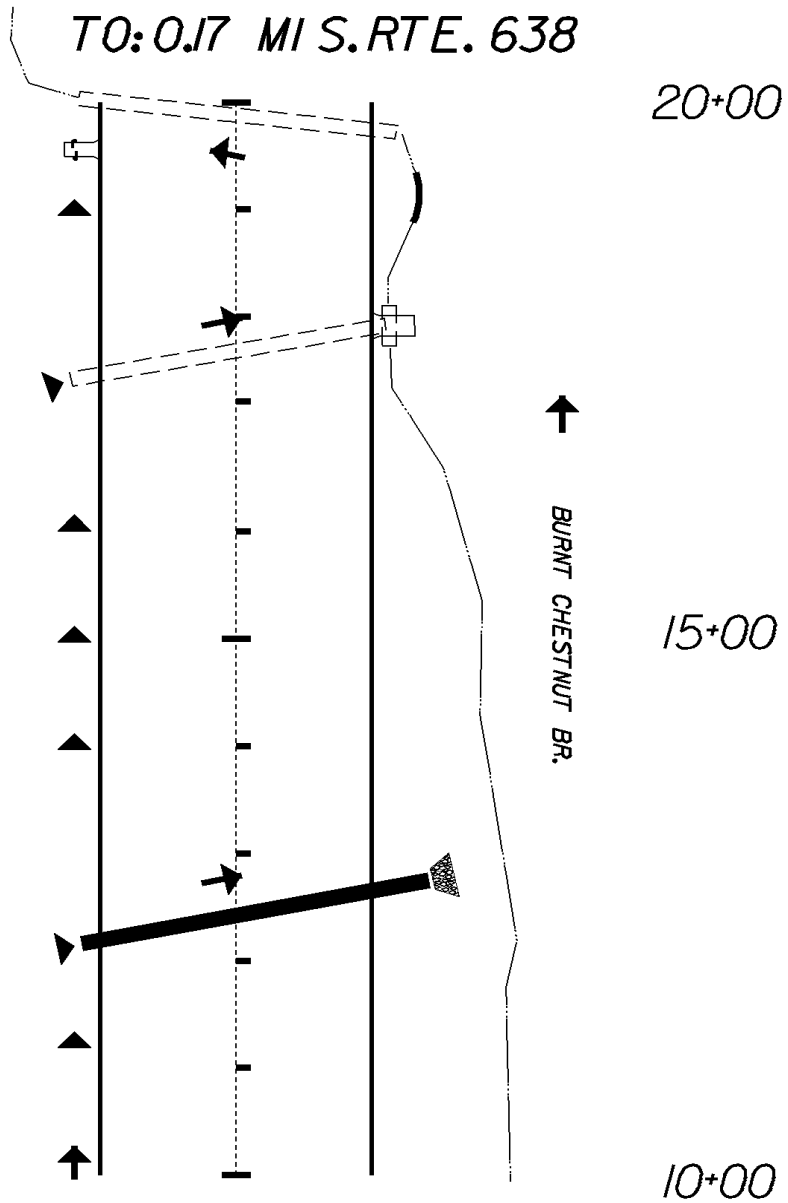

* ALL LOCATIONS ARE APPROXIMATE AND ARE SUBJECT TO CHANGE BY ENGINEER
* NOT TO SCALE

*

RTE.628, BUCHANAN COUNTY
FR: 0.67 MI. S. RTE.638
TO: 0.17 MI S. RTE. 638

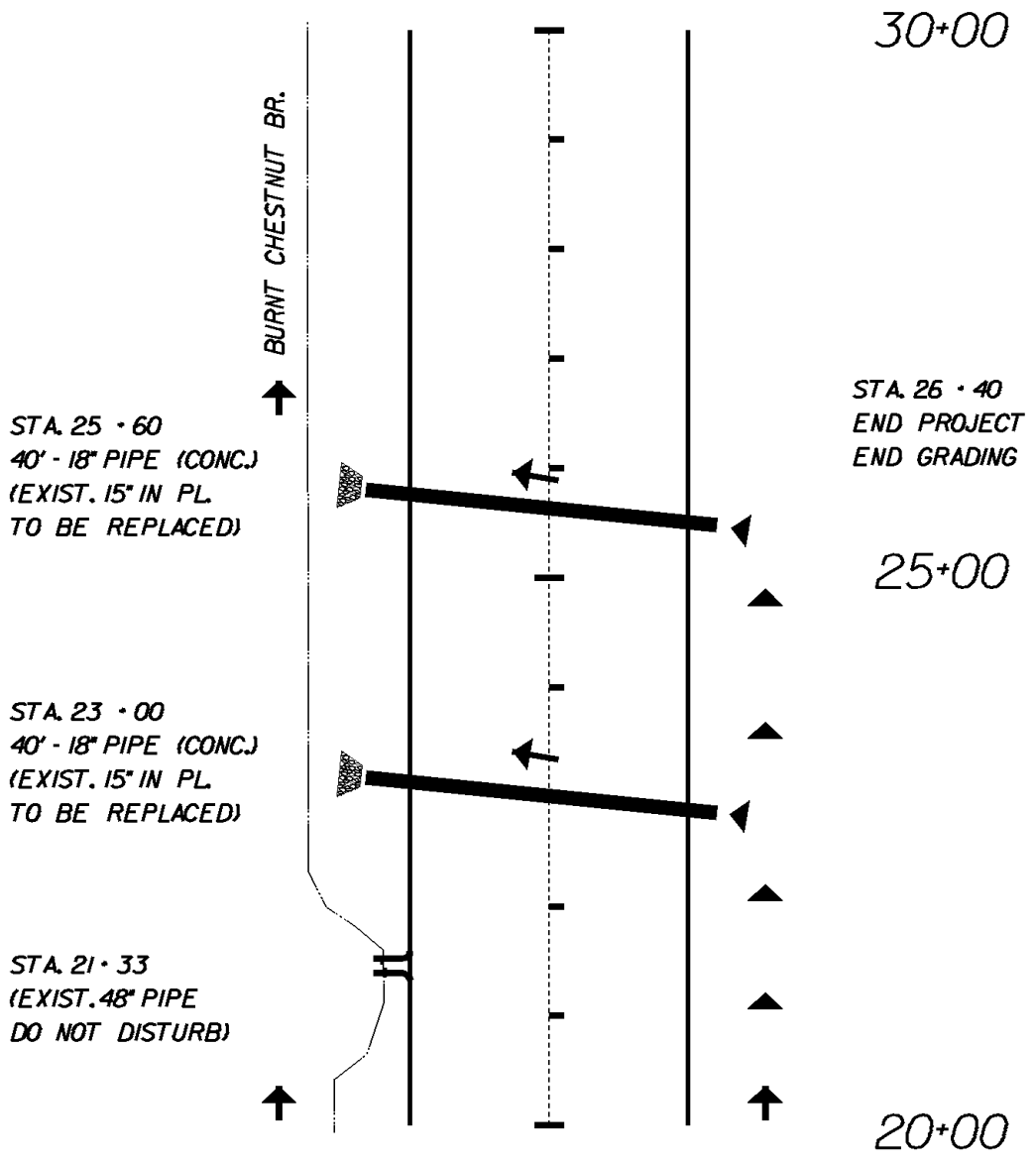

* ALL LOCATIONS ARE APPROXIMATE AND ARE SUBJECT TO CHANGE BY ENGINEER
* NOT TO SCALE

*

ROADSIDE DEVELOPMENT

Rev. 7-03

CORE MIX

| MIX | LBS./ACRES | DESCRIPTION |
|------------------------------|------------|---|
| 1 | 100 | * 100% CERTIFIED FINE FESCUE |
| 2 | 100 | 100% CERTIFIED TALL FESCUE |
| 3 | | 50% CERTIFIED TALL FESCUE * 50% CERTIFIED FINE FESCUE |
| 4 | | 50% ORCHARD GRASS 50% CERTIFIED KENTUCKY BLUEGRASS |
| 5 | | 100% BERMUDA GRASS |
| TEMPORARY | | |
| 3/1 - 5/16 and 8/16 - 3/1 | | 50% CERTIFIED TALL FESCUE 50%, BARLEY, WINTER RYE OR WINTER WHEAT |
| 5/16 - 8/16 | | 50% FOXTAIL MILLET 50% CERTIFIED TALL FESCUE |

ADDITIVES

| TYPE | LBS./ACRES | DESCRIPTION |
|------|------------|---|
| A | | 100% LOVE GRASS |
| B | 20 | 100% BARLEY, WINTER RYE OR WINTERWHEAT |
| C | 10 | 100% FOXTAIL MILLET |
| D | 10 | 100% ANNUAL RYEGRASS |
| E | 20 | 100% CROWNVETCH (LEGUME) |
| F | | 100% SERICEA LESPEDEZA (LEGUME) |
| G | | 100 % BIRDSFOOT TREFOIL (LEGUME) |
| H | | 100 % Perennial Ryegrass |
| I | 10 | White Clover |
| J | | |
| K | | |

ALL RATES TO BE SPECIFIED BY THE DISTRICT ROADSIDE MANAGER.

* FINE FESCUES INCLUDE CHEWINGS, CREEPING RED, HARD, SHEEP

SEEDING SCHEDULE

| SLOPES SEED MIX WITH ADDITIVE | MOWED SEED MIX WITH ADDITIVE | SLOPES SEED MIX WITH ADDITIVE | MOWED SEED MIX WITH ADDITIVE | SLOPES SEED MIX WITH ADDITIVE | MOWED SEED MIX WITH ADDITIVE | |
|--|---------------------------------------|--|---------------------------------------|--|---------------------------------------|------|
| SPRING MONTH & DATE | | SUMMER MONTH & DATE | | FALL & WINTER MONTH & DATE | | |
| 4/1 - 6/1 | | 6/1 - 9/15 | | 9/15 - 4/1 | | |
| PROJECT NUMBERS | 2DI | 1D | 2CDI | 1DC | 2BI | 1B |
| *SPECIFY KIND OF FINE FESCUE | | HARD | | HARD | | HARD |

MIX REQUIREMENT THIS PROJECT

RECOMMENDATIONS FOR THE APPLICATION OF SEED MIXTURES(CORE MIX AND ADDITIVES), FERTILIZER, LIME, ETC. ARE TO BE OBTAINED FROM THE DISTRICT ROADSIDE MANAGER.*

* Rev. 1/07

SECTION OF SEED LOCATION

NOTES:

Approximately 2 acres will be disturbed on this project and will require the establishment of grasses and /or legumes.



NOTES FOR FIELD USE ONLY

Over seeding rates shall be 100% of the seed mixture supplied without fertilizer.

The Engineer will require the Contractor to perform supplemental seeding when less than 75 percent uniform stand of the permanent grass specified in the mixtures is obtained. (Annual species such as, Rye and Millet are temporary varieties and require supplemental seeding.)

NOTES APPLY TO SCHEDULE

Legume seed mixes (Birdsfoot Trefoil, Crown Vetch and Sericea Lespedeza) and Weeping Lovegrass shall not be used on shoulders and other locations flatter than 3:1 slope.

Legume Seed shall be inoculated with the appropriate strain and rate of bacteria. For hydroseeding, use five times the dry seeding rate of the inoculate.

A temporary mix of erosion control mulch, as directed by the Engineer, is to be used only on areas that are to be regraded or later disturbed, if left dormant for more than 15 days.

Erosion Control Mulch, as directed by the Engineer, is to be used on areas that are to be left dormant for more than 15 days between December 1 and february 28.

Erosion Control Mulch, as listed on the VDOT Approved Products List, shall be applied in accordance with the manufacture's recommendations.

Erosion Control Mulch shall provide 100% coverage of all denuded areas.

Spring & Summer and Fall & Winter defined for the purpose of determining whether hulled or unhulled Bermudagrass and Sericea Lespedeza seed is required:

Spring & Summer – 4/1 – 9/15 – use hulled seed
Fall & Winter – 9/15 – 4/1 – use unhulled seed

Type I mulch (Straw) to be used on newly seeded areas adjacent to all waterways, wetlands, swamps, or any area in which drainage flows toward areas under the jurisdiction of the environmental regulatory agencies.

Type I mulch shall be applied to provide a minimum 90% coverage.

Type I mulch shall be tacked with Fiber mulch at the rate of 750 lbs. per acre.

Type II mulch (Fiber mulch) may be substituted for Type I mulch at the recommendation of the District Roadside Manager.

Type II mulch shall be applied at a rate of 1500 lbs. (net dry weight) per acre to provide a minimum of 90 percent coverage, and shall be applied in a separate application.

All topsoil is to be free of hard lumps, clods, rocks and foreign debris and is to be hand raked to tie into existing lawns.

All seed must be in conformance with VDOT seed specifications for Grasses & Legumes and be provided at the project site in bags not opened and labeled for use on VDOT projects with a green tag certifying inspection by the Virginia Crop Improvement Association.*

* Rev. 1/07

PB-1

GENERAL

1. METHOD "A" PIPE BEDDING SHALL BE USED FOR ALL TYPES OF PIPE CULVERTS WITHIN THE APPLICABLE HEIGHT OF COVER RANGE NOTED IN THE STANDARD PC-1 TABLES UNLESS OTHERWISE NOTED ON THE PLANS.
2. H = HEIGHT OF COVER MEASURED FROM TOP OF CULVERT TO FINISHED GRADE.
3. b = EXCAVATION DEPTH AS SHOWN ON PLANS OR TO FIRM BEARING SOIL.

CIRCULAR PIPE

1. D = OUTSIDE DIAMETER OF PIPE.
2. d = INSIDE DIAMETER OF PIPE.
3. X = WIDTH OF CLASS I BACKFILL MATERIAL BEYOND THE EXTREMITY OF THE PIPE.
 X = 12" WHERE d IS LESS THAN 36".
 X = 18" WHERE d IS 36" AND GREATER.
4. WHERE DIRECTED BY THE ENGINEER, BEDDING MATERIAL MAY BE ELIMINATED FOR NORMAL EARTH FOUNDATIONS UNDER ROUTINE ENTRANCE PIPE (EXCEPT PLASTIC PIPE) 30" AND LESS IN DIAMETER WITH HEIGHT OF COVER 15' OR LESS.
5. REGULAR BACKFILL MATERIAL MAY BE USED IN LIEU OF CLASS I BACKFILL MATERIAL FOR ALL FOUNDATION TYPES FOR ROUTINE ENTRANCE PIPE (EXCEPT PLASTIC PIPE) 30" AND LESS IN DIAMETER WITH HEIGHT OF COVER 15' OR LESS.
6. BEDDING MATERIAL AND CLASS I BACKFILL MATERIAL MAY BE ELIMINATED FOR SHOULDER SLOT INLET (DI-13) OUTLET PIPES INSTALLATIONS.

ELLIPTICAL PIPE

1. S₁ = OUTSIDE SPAN DIMENSION OF PIPE.
2. S₂ = INSIDE SPAN DIMENSION OF PIPE.
3. R = OUTSIDE RISE DIMENSION OF PIPE.
4. X = WIDTH OF CLASS I BACKFILL MATERIAL BEYOND THE EXTREMITY OF THE PIPE.
 X = 12" WHERE S₂ IS LESS THAN 36".
 X = 18" WHERE S₂ IS 36" AND GREATER.
5. WHERE DIRECTED BY THE ENGINEER, BEDDING MATERIAL MAY BE ELIMINATED FOR NORMAL EARTH FOUNDATIONS UNDER ROUTINE ENTRANCE PIPE WHERE S₂ IS 38" OR LESS AND HEIGHT OF COVER 15' OR LESS.
6. REGULAR BACKFILL MATERIAL MAY BE USED IN LIEU OF CLASS I BACKFILL MATERIAL FOR ALL FOUNDATION TYPES FOR ROUTINE ENTRANCE PIPE WHERE S₂ IS 38" OR LESS AND HEIGHT OF COVER 15' OR LESS.

PIPE ARCH

1. S = SPAN DIMENSION OF PIPE.
2. R = RISE DIMENSION OF PIPE.
3. B = SEE PC-1 TABLE FOR APPLICABLE PIPE MATERIAL.
4. x = WIDTH OF CLASS I BACKFILL MATERIAL BEYOND THE EXTREMITY OF THE PIPE.
 x = 12" WHERE S₂ IS LESS THAN 36".
 x = 18" WHERE S₂ IS 36" AND GREATER.
5. WHERE DIRECTED BY THE ENGINEER, BEDDING MATERIAL MAY BE ELIMINATED FOR NORMAL EARTH FOUNDATIONS UNDER ROUTINE ENTRANCE PIPE WHERE S₂ IS 35" OR LESS AND HEIGHT OF COVER 15' OR LESS.
6. REGULAR BACKFILL MATERIAL MAY BE USED IN LIEU OF CLASS I BACKFILL MATERIAL FOR ALL FOUNDATION TYPES FOR ROUTINE ENTRANCE PIPE WHERE S IS 35" OR LESS AND HEIGHT OF COVER 15' OR LESS.

**INSTALLATION OF PIPE CULVERTS AND STORM SEWERS
GENERAL NOTES**

NEW. 1/04

107.00

VIRGINIA DEPARTMENT OF TRANSPORTATION

NEW 1/04

SPECIAL DESIGN SECTION
DRAWING NO. A-151

SPECIFICATION
REFERENCE

302
303

*

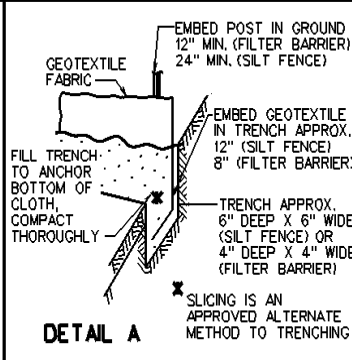
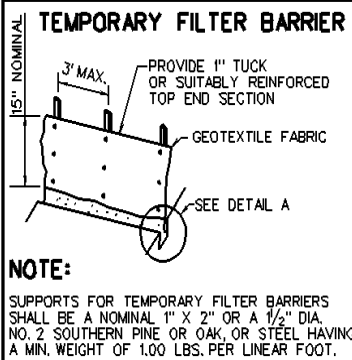
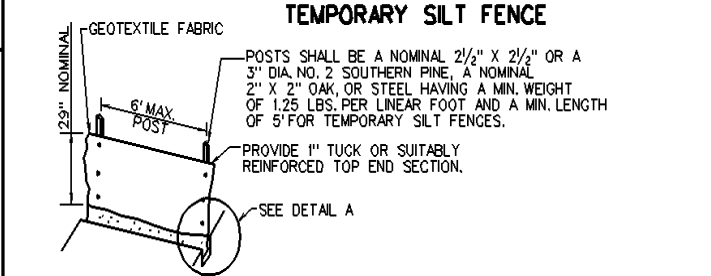
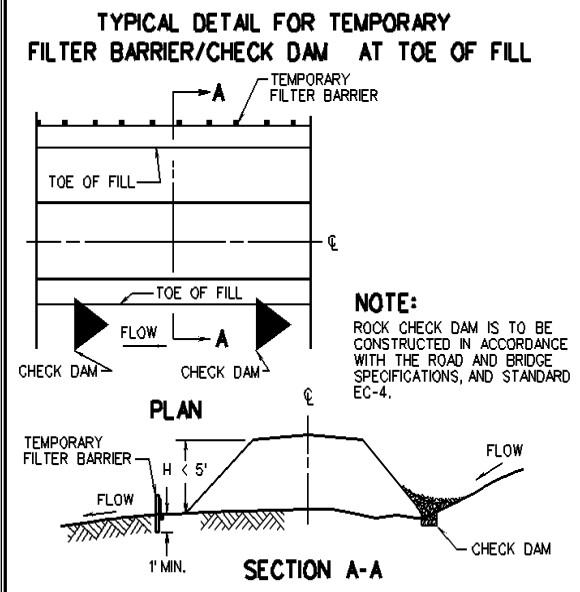
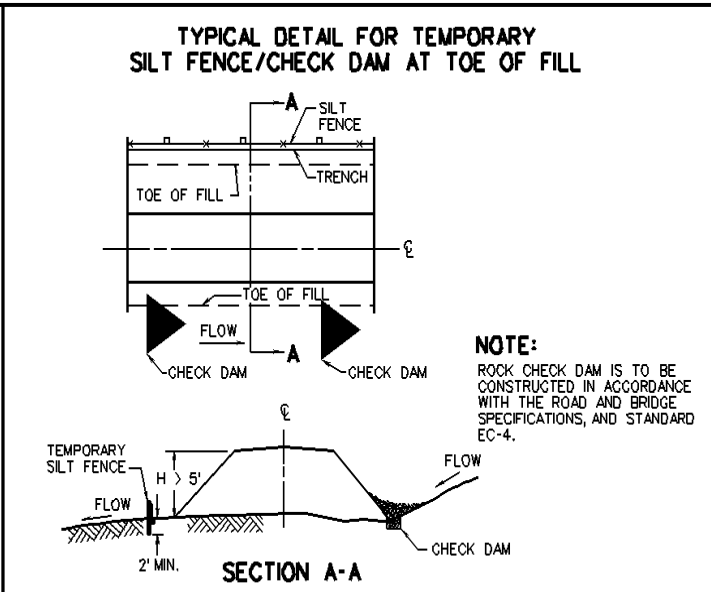
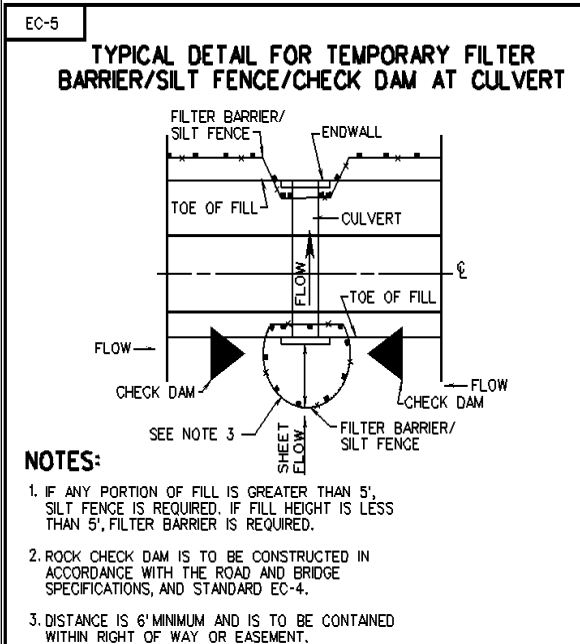

TEMPORARY SILT FENCE AND FILTER BARRIER

REV. 3/03
114.06

VIRGINIA DEPARTMENT OF TRANSPORTATION

NEW. 3-03
SPECIAL DESIGN SECTION
DRAWING NO. 414-1

| SPECIFICATION REFERENCE |
|-------------------------|
| 107 |
| 242 |
| 303 |

* Rev. 1/07

ESC-INS

SUGGESTED METHOD OF TEMPORARILY PLACING RIPRAP FOR EROSION CONTROL IN CHANNELS, DITCHES, & AT TOE OF FILL SLOPES

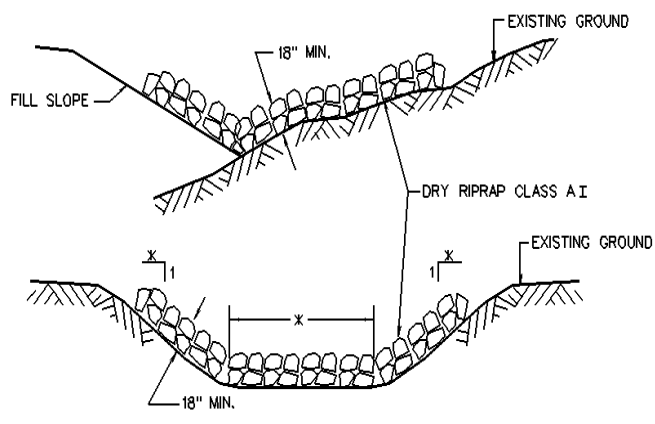

NOTES:

1. THE DEPTH OF PROTECTION WILL DEPEND ON WHATEVER DEPTH IS ATTAINABLE, WITH THE RIPRAP BEING EVENLY SPREAD WITH THE QUANTITY SHOWN ON THESE PLANS. RIPRAP MAY BE ADDED OR DELETED AS FOUND NECESSARY BY THE ENGINEER.
- * SIDE SLOPES AND BOTTOM WIDTH (IF TRAPEZOIDAL) SHOWN IN TYPICAL SECTION OF PROPOSED DITCH OR CHANNEL.

MINIMUM REQUIREMENTS FOR STABILIZED CONSTRUCTION ENTRANCE

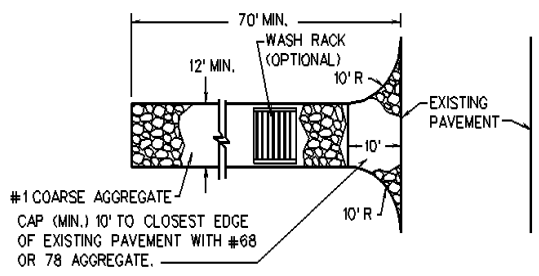

PLAN

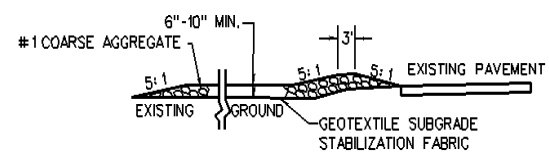

PROFILE

1. SURFACE WATER SHALL BE PIPED UNDER THE CONSTRUCTION ENTRANCE. IF PIPING IS IMPRACTICAL, A MOUNTABLE BERM WITH 5:1 SLOPES WILL BE PERMITTED.
2. THE ENTRANCE SHALL BE MAINTAINED IN A CONDITION WHICH WILL PREVENT TRACKING OR FLOWING OF SEDIMENT ONTO PUBLIC RIGHT OF WAY. THIS MAY REQUIRE PERIODIC TOP DRESSING WITH ADDITIONAL STONE AS CONDITIONS DEMAND AND REPAIR AND/OR CLEANOUT OF ANY MEASURES USED TO TRAP SEDIMENT. ALL SEDIMENT SPILLED, DROPPED, WASHED OR TRACKED ONTO PUBLIC RIGHT OF WAY SHALL BE REMOVED IMMEDIATELY.
3. WHEELS SHALL BE CLEANED TO REMOVE SEDIMENT PRIOR TO ENTRANCE ONTO PUBLIC RIGHT OF WAY. WHEN WASHING IS REQUIRED, IT SHALL BE DONE ON AN AREA STABILIZED WITH STONE AND WHICH DRAINS INTO AN APPROVED SEDIMENT TRAPPING DEVICE.
4. PERIODIC INSPECTION AND NEEDED MAINTENANCE SHALL BE PROVIDED AFTER HEAVY USE AND EACH RAIN.

SHEET 1 OF 3

SPECIFICATION REFERENCE

107
303

TEMPORARY EROSION & SILTATION CONTROL

VIRGINIA DEPARTMENT OF TRANSPORTATION

REV. 7/04
SPECIAL DESIGN SECTION
DRAWING NO. 414.4

REV. 7 /04
115.01

* Rev. 1/07

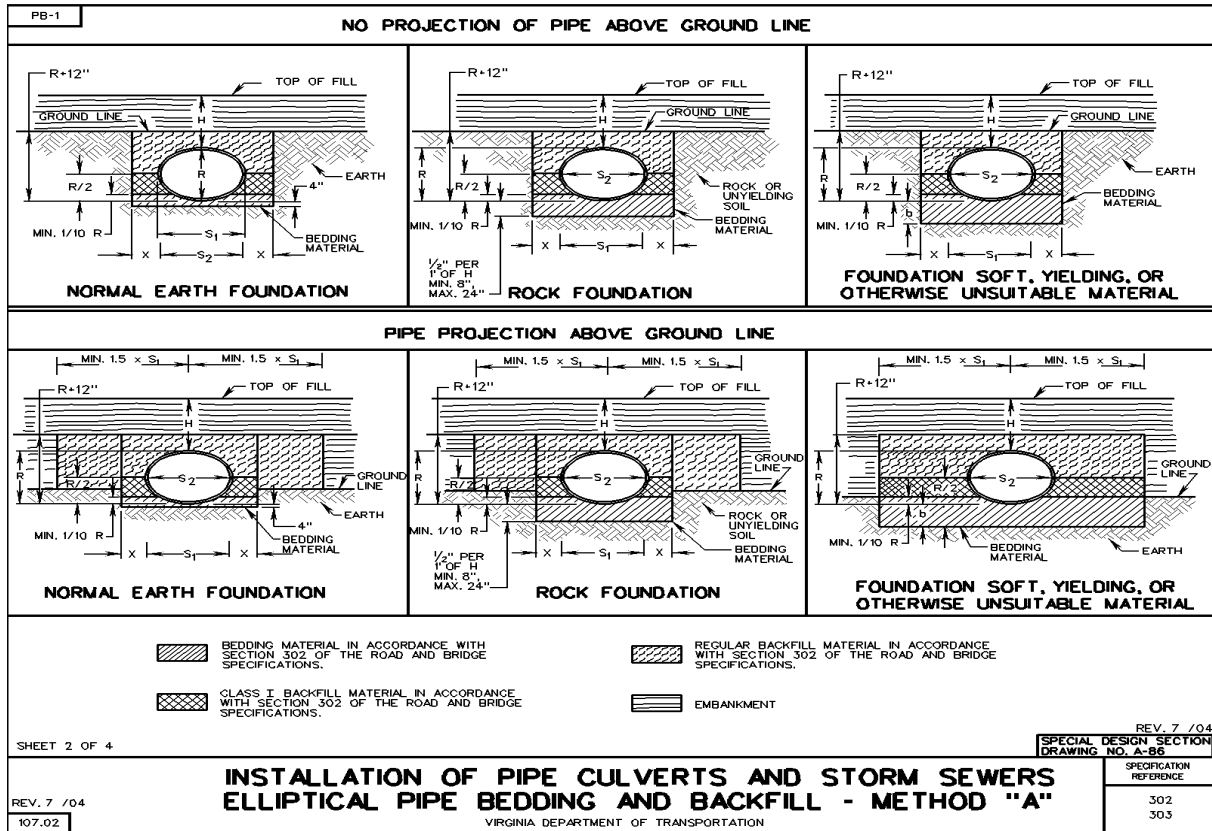
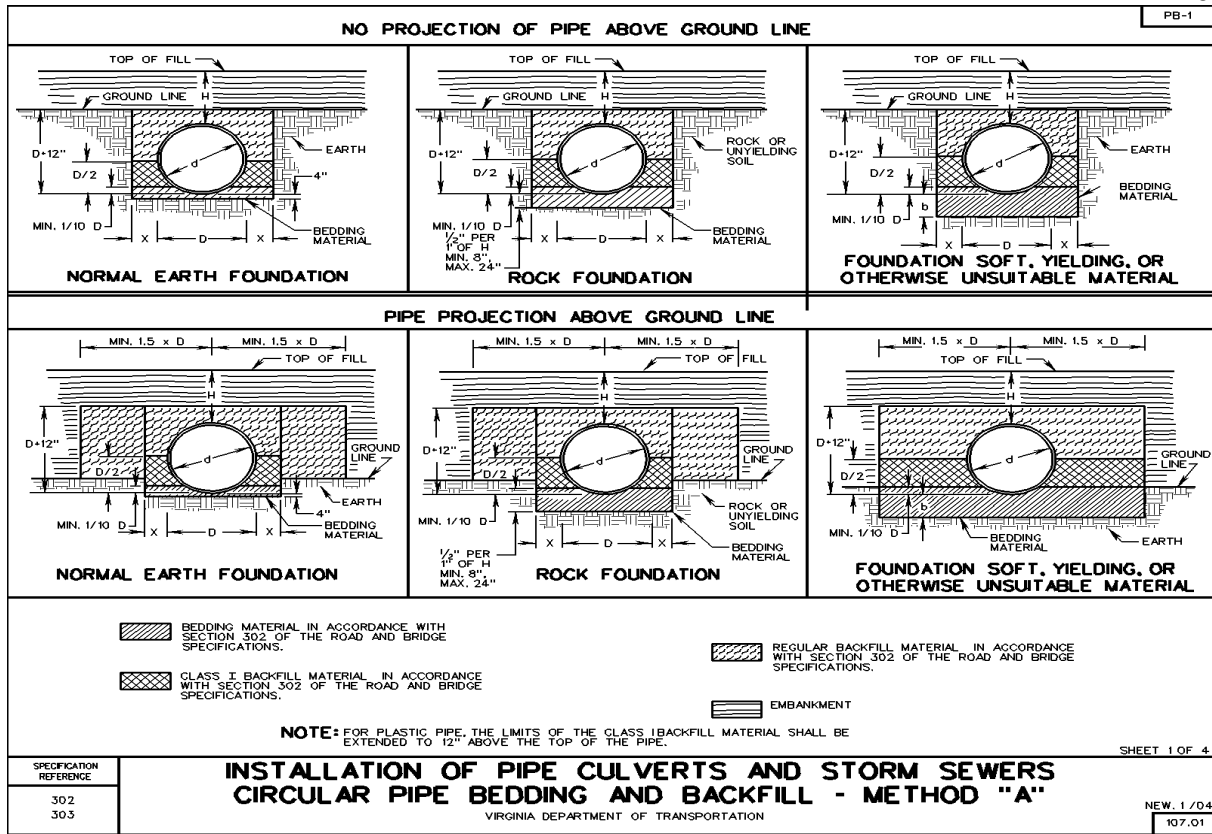

SECTION A-8-SEQUENCE OF CONSTRUCTION/ TRANSPORTATION MANAGEMENT PLANS (TMP)

INTRODUCTION

Transportation Management Plans (TMP) are required on all Type A, B and C* projects. TMP's consist of the following strategies (or plans): Temporary Traffic Control, Public Communication and Transportation Operations. Refer to [LD-IIM-241](#) for guidance.

These guidelines serve as a tool to assist the designer in plan preparation. Sequence of construction, temporary traffic control plans and constructability are related topics and significantly affect the quality of our plans. Broad issues of constructability and quality control are commented on; however they are not the focus of these guidelines. The purpose is to familiarize individuals with the technique and importance of preparing an adequate sequence of construction and temporary traffic control plans. Constructability issues concerning sequence of construction and temporary traffic control plans are covered. Reference material is located elsewhere in this section and in the Instructional and Informational Memoranda ([LD-IIM-241](#)). References listed at the end of these guidelines provide additional resources and the list of items to consider may serve as a checklist.

As related issues, the sequence of construction and temporary traffic control plans are included in one plan. The plan includes diagrams and appropriate notes to inform the contractor of when each operation is to be accomplished. The plan delineates traffic control procedures necessary prior to, during and following construction. The sequence is to be a guide with a step by step procedure from the beginning to the end of construction. It is important to provide the plan in a clear and easy to follow manner. Do not sacrifice plan clarity to reduce pages. The plan is necessary to insure that a project can be built as designed without undue difficulty and with minimum work orders. Developing a sequence of construction and temporary traffic control plans is an essential part of the overall project design and may affect the design of the facility itself. Design of the proposed improvements should be coordinated with the temporary traffic control plans. There may be acceptable design alternatives which would improve tie-ins to existing pavement and facilitate significantly smoother flowing sequence of construction and temporary traffic control plans.

A plan is necessary for complex projects when construction warrants a step by step explanation of the construction process. Such projects may have high traffic volumes, peak hour traffic backups, major cuts and fills, major drainage structures, bridges, or utility relocations requiring traffic detours or shifts. Begin planning in the very early stage of design and continue to solicit assistance throughout the design process to finalize the plan. Request input at Field Inspection and other appropriate meetings as necessary.

* Rev.1/09

Throughout the design process it is important to keep in view the big picture. Before beginning to prepare a sequence of construction plan, walk or drive the project to become familiar with the project and critical construction areas. Take notes, make sketches, video tape and take pictures to assist in communicating issues to consider.

Develop a draft sequence of construction plan, thinking through each step as it relates to the other steps. These guidelines contain some helpful suggestions and references. Reviewing examples of well prepared sequence of construction plans is an excellent way to learn about the various issues. Brain storm alternative construction sequences to arrive at the most practical. It may be helpful to color code each phase of construction and make a written narrative of each phase.

Seek advice from individuals, sections or other divisions with particular expertise or experience necessary in preparing sequence of construction plans. Methods of obtaining advice include requesting individuals to review a sequence plan or setting up a meeting to discuss concerns and alternative solutions. There is a wealth of knowledgeable and experienced individuals within VDOT to consult when preparing sequence of construction and temporary traffic control plans.

The road designer should consult and coordinate input from the Scheduling and Contract, Environmental, Asset Management, Materials, Right of Way, Structure and Bridge, Traffic Engineering, and Local Assistance Divisions, the Project Engineer and Inspector throughout the process of developing a sequence of construction and temporary traffic control plans. It may be appropriate to contact the District and Central Office representatives of referenced Divisions, particularly the **Regional*** Traffic Engineer. Advantage should be taken of all opportunities to solicit public input concerning the planned sequence of construction and temporary traffic control plans. The public commutes the subject area every day and is in a position to point out situations of concern. Evolution of a sequence of construction and temporary traffic control plans is an ongoing process and modifications will be necessary prior to and during construction as issues surface or difficulties develop.

The road designer is responsible for preparation of the plan for inclusion in the plan assembly. Preparation will involve requesting, coordinating and organizing input from numerous other individuals. The designer is not expected to know all of the traffic control options and construction techniques and other related expertise necessary to prepare a comprehensive plan. The plan should be located in the front portion of the plan assembly, within the 1 series of sheets.

The Location and Design policy concerning sequence of construction and temporary traffic control plans is as follows:

Preliminary Temporary Traffic Control Plans/Sequence of Construction Plans are to be developed by the roadway designer in the earliest possible stage of plan development and reviewed by the **Regional** Traffic Engineer prior to Field Inspection.

* Rev. 7/10

Temporary Traffic Control Plans/Sequence of Construction Plans should safely and efficiently maintain traffic while providing capacity and operating speed comparable to the typical highway conditions where feasible.

The following note is to be shown on the Temporary Traffic Control Plans/Sequence of Construction Plan:

"Unless otherwise approved or directed by the Engineer, the Contractor shall plan and prosecute the work in accordance with the following:"

The Regional Traffic Engineer will determine locations where detailed plans for traffic control devices are required for inclusion in the final Temporary Traffic Control Plans /Sequence of Construction Plan.

Following the Field Inspection, plans are revised to incorporate the District *Engineer/Administrator's Field Inspection recommendations, and the electronic files are updated and will be provided to the Regional Traffic Engineer. The Regional Traffic Engineer will provide recommendations to the roadway designer to prepare the necessary traffic control devices for inclusion in the construction plan assembly.

The Temporary Traffic Control Plans/Sequence of Construction Plans are reviewed as follows:

1. Quality Review for Field Inspection
2. Field Inspection
 - a. Recommendations from the District *Engineer/Administrator at Field Inspection are submitted to the Project Manager.
 - b. After accepted Field Inspection recommendations have been incorporated into the plans, prints are provided to the Regional Traffic Engineer and State Traffic Engineer for review prior to Public Hearing/Right of Way Stage.
 - c. Detours, right of way, and easements must be completed in sufficient detail for the right of way requirements to be incorporated into Public Hearing/Right of Way plans.
3. Right of Way and Constructability Review
4. Advertisement Quality Review
5. Pre-advertisement meeting

SEQUENCE OF CONSTRUCTION

A sequence of construction plan is to include diagrams and appropriate notes to inform the contractor of when each operation may be accomplished and advise of traffic control necessary during construction.

Except for the most simple projects, a sequence of construction is necessary. Delays and redesign during construction are often extremely costly, may also cause an unsafe situation and can unnecessarily cause additional disruption of traffic patterns. Our desire is to minimize the inconvenience to the public. To the extent possible, the plan should have flexibility. Recognize that the contractor may, with the Engineer's approval, modify the sequence of construction, but to approach a project without a plan is risky. The sequence may seem simple at first glance but thinking through the steps helps make us aware of possible difficulties. Each project presents unique challenges and developing a sequence of construction offers opportunities to address these concerns at an early stage.

The road designer is responsible for determining the need for barricades and detours during construction. The designer is also to review the plans carefully to determine if it will be necessary to shift traffic lanes away from the normal position during construction and determine required easements. If shifting lanes is necessary, a sequence of construction is to be prepared by the designer with input from the appropriate Assistant Scheduling and Contract Engineers and/or Assistant District Engineer. The sequence of construction plan is to be reviewed by District office representatives and individuals from applicable divisions and agencies at each stage of plan development. The Scheduling and Contract, Environmental, Asset Management, Materials, Right of Way, Structure and Bridge, Traffic Engineering, and Local Assistance Divisions, Project Engineer and Inspector should be consulted concerning their respective areas of responsibility.

When a Sequence of Construction Plan is necessary, it will be included in the plans that are distributed for review at the Field Inspection and it will be of sufficient detail to present the basic concept for discussion and determination of environmental, traffic, safety, and right-of-way requirements. Reviewing examples of well prepared sequences of construction plans is an excellent way to learn about the various issues to be addressed. Examples should address different construction challenges. Discussion should take place at the Field Inspection concerning a narrative if a Sequence of Construction Plan is not necessary. All of the above items are to be discussed thoroughly at the Field Inspection and recommendations included in the Field Inspection Report. *

* Rev. 7/06

A copy of the sequence of construction plan, with the accepted Preliminary Field Inspection recommendations incorporated, is to be furnished to the Traffic Engineer prior to the Field Inspection/Right of Way stage. If detours, right of way or easements are required for the temporary traffic control plans*, the sequence of construction must be completed in sufficient detail for the right of way requirements to be incorporated into the Field Inspection /Right of Way plans.

When a sequence of construction plan or narrative is unnecessary for a particular project, the file will be documented accordingly with the listing of the names of those involved in the decision and the reasons for the decision. The field inspection prints must also indicate that a sequence of construction plan or narrative is not necessary and that only such items as flagging, warning lights, etc., will be required.

ITEMS TO ADDRESS UNDER SEQUENCE OF CONSTRUCTION:

Adjoining projects and sequence of construction must be coordinated. There may be occasions where a portion of one project would be more efficiently constructed at a designated stage of the construction sequence of another project. This may apply at intersections or other locations. Surplus material may be utilized from an adjoining project. Section 105 of the [Road and Bridge Specifications](#) specifies that there shall be cooperation among contractors on adjoining projects.

Bridge construction should be addressed in the sequence of construction. The coordination of the bridge construction with the roadway portion should be evaluated relative to connecting temporary bridge parapet with the traffic barrier service to insure the proper tie when performing the installations. Bridge construction often requires very large cranes and other large equipment and materials. It is desirable to avoid constructing a bridge in sections. Also avoid setting beams over traffic. Input should be furnished by the Structure and Bridge, Scheduling and Contract and Traffic Engineering Divisions to provide a plan taking these issues into account. Detours may be necessary during periods of bridge construction.

Construction activity: Sequences of construction should be designed to prevent worker activity left and right of traffic at the same time. This situation makes the driver feel restricted, slows traffic and endangers workers. Construction normally takes place on the outside portion of the project and moves in (on major widening or reconstruction projects). Weather and other factors impact the length of construction time. Weather may affect concrete pavement and other concrete construction.

Drainage: Temporary ditches or pipes may be necessary. Replacement of existing drainage may require a temporary diversion ditch or pipe. Jacking versus open cut for pipe causes less interruption to traffic but is normally a considerably more expensive method of pipe installation.

* Rev. 7/08

Proposed pipes under roadways with high traffic volumes or difficult detours options are candidates for jacking. New construction and extensions of box culverts require considerable construction time. Urban projects should incorporate precast drainage items as much as practical, since improvements in urban areas are generally adjacent to and performed under traffic. Precast items would reduce worker exposure time to traffic and vice-versa since a precast item can be installed much quicker than a cast in place item. Openings for cross-drain pipes on interstates should be designed to prevent small children and animals from accessing the freeway.

Environmental concerns include avoiding wet lands and seeding disturbed slopes at the earliest appropriate stage of construction.

Excavation and earthwork: The Grading Summary and material hauls must match maintenance of traffic and sequence of construction plans. Consider borrow material versus surplus material at each stage of the sequence. Address locations where surplus material may be placed. Areas of graded slopes may be appropriate locations to waste surplus material. Consider areas of major cut or fill to anticipate slope tie in difficulties. In development of the Grading Diagram and Summary, it is essential that the project sequence of construction be taken into consideration to avoid specifying use of material which is not available in the appropriate phase of construction. On complex projects, it may be necessary for the designer to develop rough grading diagrams and summaries for each phase of work to accurately determine the grading effort required.

Example plans: Review example plans and seek advice from individuals with experience.

Funeral homes and Churches: Construction should be prohibited in the immediate vicinity of funeral homes and churches during services. This is common courtesy and enhances public relations. This consideration will normally be addressed during preconstruction meetings, but may warrant a plan note.

Intersection reconstruction may require a Sequence of Construction/Temporary Traffic Control Plans* as these areas may be very involved.

Material hauls: The contractor should plan the transfer of materials and equipment in a manner that minimizes the impact on traffic movement, as much as practical.

Nighttime construction: In order to reduce the disruption of traffic flow and avoid stopping traffic, certain construction activities, such as the placement of bridge beams or overhead sign structures should be accomplished at night. However, additional safety precautions may be necessary when accomplishing this activity.

* Rev. 7/08

Note in the plans that the Contractor shall plan and execute the work in accordance with the Sequence of Construction Plan unless a change is approved or directed by the Engineer.

Note in the plans that it is not the intent of the sequence of construction plan to enumerate every detail which must be considered in the construction of each stage, but only to show the general handling of traffic.

Pavement or structure demolition sequence should be considered.

Railroad crossings or construction adjacent to rail lines should be considered. Input should be obtained from the Virginia Department of Rail and Public Transportation concerning special requirements. Avoid situations where traffic signals, road intersections, road grades and etc. could trap vehicles on the tracks.

Sound barrier walls: The sequence of constructing sound barriers should be closely reviewed, especially when located on the shoulder, since access for work vehicles may require a lane closure. Consideration should be given to sound barrier construction at an early stage of the project construction to help shield adjacent areas from noise.

Time of day, holidays or other day and time restrictions may be necessary stating when construction or traffic flow restraints are not allowed. Notes may be necessary stating specific dates/times. Local ordinances such as noise may restrict when work can be performed. Section 105 of the [Road and Bridge Specifications](#) specifies restricts Holiday work times unless permission is granted by the Engineer.

Utilities: On some projects utility relocations are complete prior to beginning the road construction. Existing utilities should be addressed in the sequence of construction as to when and by whom they will be relocated. A portion of the road construction may be necessary prior to installing or relocating utilities.

Walk or drive the project: Take pictures, notes, video and make sketches. This process will help in recalling and conveying to others the areas of concern.

TEMPORARY TRAFFIC CONTROL PLANS*

A temporary traffic control plan is necessary to insure that motorists, pedestrians and construction workers can safely travel or perform their jobs during roadway construction. A well-thought-out and carefully developed plan will contribute significantly to the safe and expeditious flow of traffic as well as the safety of the construction forces. The goal of any maintenance of traffic plan should be to safely route vehicle, bicycle, worker and pedestrian traffic, including persons with disabilities, through or around construction areas.

* Rev. 7/08

Geometrics and traffic control devices should operate in a manner comparable to the existing operating situation while providing room for the contractor to work effectively. A temporary traffic control plan informs the contractor in writing as to how we expect the traffic to be maintained throughout the project and how the summaries have been worked up. The plan may constitute a traffic maintenance sequence and include drawings and diagrams to convey instructions. Traffic flow arrows are recommended.

It is advantageous to prepare and evaluate the temporary traffic control plans from the motorist's point of view. We have all been delayed in traffic due to road construction. Many times it is unavoidable. Preparing an efficient temporary traffic control plan is one way we can better serve the public. It has been said that the shortest distance between two points is always under construction. This may be the public's perception when they are inconvenienced. Imagine how a driver would view the plan in operation.

Realize that there may be an element of surprise or uncertainty for the driver, who will likely be unfamiliar with the revised traffic pattern and hazards. The temporary traffic control plans must be coordinated with the sequence of construction. Reviewing examples of well prepared maintenance of traffic plans is an excellent way to learn about the various issues to be addressed. The examples should address different construction challenges. Do not hesitate to seek advice from Divisions, sections or individuals with expertise or experience in preparing a temporary traffic control plan, particularly the **Regional*** Traffic Engineer.

Maintaining a safe flow of traffic during construction must be carefully planned and executed. Although it is often better to provide detours, frequently it will be necessary to maintain the flow of traffic through the construction area. Construction areas are protected by barriers, appropriate speed limits, channelizing devices, signs, signals, lighting, impact attenuators, truck mounted crash cushions and flagging to provide safe traffic control during construction. Construction area devices may include variable message signs or divided highways. Sometimes it will also be necessary to encroach on the through-traffic lanes or shift lanes entirely in order that the construction can be undertaken. When this is necessary, designs for traffic maintenance should produce as minimal an effect as possible on normal traffic flow. The plan depends on the nature and scope of the improvement, volumes of traffic, highway or street pattern, and capacities of available highways or streets. The plan should have some built-in flexibility to accommodate unforeseen changes in work schedule, delays, or traffic patterns.

Adequate advance warning and sufficient follow-up information are needed for the motorist. Standards for the use and application of signs and other traffic control devices when highway construction occurs are set forth in Part VI of the Federal Highway Administration's [*Manual on Uniform Traffic Control Devices*](#), MUTCD. Designs for the use and application of signs and other traffic control devices are developed by the Traffic Engineering Division of VDOT. Traffic control devices instructions published by the Traffic Engineering Division are included in [*The Virginia Supplement to the Manual on Uniform Traffic Control Devices*](#).

* Rev. 7/10

Part VI of the Virginia Supplement was modified and reproduced as a separate publication, [Virginia Work Area Protection Manual](#). Location and Design is responsible for the design of the facilities (except bridges) to accommodate the traffic.

The stopping of public traffic by a flagger or any other means should be avoided where possible and should be approved by the District *Engineer/Administrator. Designs that provide for constant movement around an obstruction in the roadway, even if it is slow, are more acceptable and are less irritating to drivers than requiring them to stop. Construction operations frequently create the need for adjustments in traffic patterns including the shifting of lanes.

Splitting traffic in the same direction on both sides of construction is not acceptable. The minimum taper length for lane transitions in construction areas can be computed by a formula found in the MUTCD. Various configurations are illustrated in the MUTCD and should be used in developing temporary traffic control plans.

Designed shifts in traffic flows are to conform to the geometrics shown in the standards for detours (Standard GS-10) and/or as indicated in the "Safety Guidelines for Construction Zones" (See [IIM LD- 93](#)).

Depending on various project conditions, the Traffic Engineering Division may recommend one of the following methods of maintaining traffic for a project.

A. Under the following circumstances a simple sequence would normally be used:

1. If the Average Daily Traffic volume (ADT) is 1000 or less.
2. If there are no pipes that are 48" or greater in diameter.
3. If there are no double lines of 24" pipe or greater.
4. If there are no major drainage structures.
5. If no major off-site detours are required.
6. If there are no major utility relocations required.

A simple sequence may read:

"Traffic is to be maintained throughout the project on the present road or on the grade where the present road is to be raised or lowered. Short periods of one-way, flag controlled traffic may be allowed at the option of the Engineer."

B. Under the following conditions a simple sequence requiring time restrictions should be considered, but keep in mind that these are only meant to be used as general guidelines. Time restrictions may not be necessary in all of the following situations:

1. If the ADT is 1000 or more and could present a problem with peak-hour traffic backup;
2. If there are pipes larger than 48" in diameter;
3. If there are double lines of 24" pipe or larger.
4. If there are major drainage structures.

A simple sequence with "time" restrictions may read:

"Traffic is to be maintained throughout the project on the present road or on the grade where the present road is to be raised or lowered with a minimum lane width of _____. Two-way traffic is to be maintained between the hours of _____:_____ a.m. to _____:_____ p.m. weekdays, and at all times on Saturdays, Sundays and Holidays, unless otherwise directed by the Engineer."

- C. A more in depth sequence or an off-site detour may be required in situations where neither of the simple sequences listed above are appropriate. This may require a step by step description of the sequence.

When construction operations are scheduled to take place adjacent to passing traffic, a clear zone should be called for in the plans between the work and the passing traffic. Under most conditions, positive barriers or time restrictions are justified.

ITEMS TO BE ADDRESSED UNDER MAINTENANCE OF TRAFFIC INCLUDE:

Access to adjacent residential and commercial properties should be maintained at all times. Temporary traffic control plans and sequence of construction notes should reflect this policy and emphasize the requirement at fire stations, emergency rooms and other emergency facilities. Section 104 of the [Road and Bridge Specifications](#) specifies that entrances shall be maintained.

Asphalt medians: Temporary medians should be considered where construction creates situations with new traffic patterns for motorists. This channelizing will provide improved safety by forming a positive separation of opposing traffic.

Concrete* Barrier, attenuator service and truck mounted attenuator guidelines and standards are contained in the Construction Zone Safety IIM LD-93. [Standards/Special Design Section](#) will be contacted to design the Impact Attenuators. The location of drums, barriers, or barricades, as means of channelizing traffic, shall be detailed in the temporary traffic control plans when special conditions exist. **Concrete barrier and Channelizing devices requirements** are addressed in the [Virginia Work Area Protection Manual](#). Concrete barrier placement is important. There will be instances when construction access in runs of traffic barrier service will be necessary for the contractor to access materials and equipment. These locations should be reviewed to determine if attenuators or a transition is needed. Runs of traffic barrier should be properly transitioned on either end, in the clear zone, as indicated in the [Virginia Work Area Protection Manual](#), for the operating speed during construction. **For additional information see Appendix I.**

* Rev. 11/15

Otherwise, temporary impact attenuators will be required. Applicability of Quickset Barrier System; use of Quick Change barriers may facilitate changing the number of lanes during rush hour. There may be times when it is practical to implement the Quick-change Traffic Barrier System to maintain roadway capacity in the AM and PM peak hours, yet provide additional work space for specific work activities during off-peak times. The NEAT attenuator system is an end treatment for temporary work zones which has FHWA approval for use on these barrier systems.

Bridges; Temporary bridges may be cost effective for reconstruction of existing bridges.

Bridge rails, existing: In many instances, existing bridges do not have the accepted approach guardrail runs and terminal treatments. Due to the unusual and distracting work techniques used in bridge construction that may be in the immediate vicinity of traffic during the erection of the proposed structure, maintaining traffic on the existing structure may require guardrail, at least on the right side of approaching traffic to eliminate run off the road or fixed object impacts by an errant motorist.

Clear zone: Clear zone requirements should be maintained and the contractor should be instructed to maintain the clear zone free of stored materials and parked equipment as much as practical.

Construction equipment: Idle construction equipment must not impact sight distances at intersections and especially in school zones or entrances. When the construction site is in the vicinity of an airport, consideration should be given to include a note on the plans that the contractor shall be responsible to insure construction equipment does not violate Federal or airport clearance regulations.

Coordinate work: There may be times that several contractors are working in the same vicinity. During these times advanced work zone signing should be coordinated to insure driver expectancy is not compromised by the placement of unnecessary or conflicting signing.

Detours may be necessary to provide the smoothest and safest traffic flow around work zones. If a temporary detour is shown in the temporary* traffic control plans, it should be graphically indicated in the plan assembly, with the proper directional advanced signing for the contractors guidance prior to initiating work activities. Address issues of alignment, grade, length, width, pavement strength, truck restrictions, detour capacity for rerouting traffic, detour quantities (including grading, drainage, pavement, etc.) and a detour removal detail (with pay items). Temporary detour grades are necessary where such grades are not obvious such as paralleling existing pavement. When shoulders are used as a detour, the pavement width and strength should be reviewed to accommodate the appropriate vehicle loads.

* Rev. 7/08

Detour operating speed should approximate existing highway operating speed (every attempt should be made to not reduce the speed by more than 10 mph). Attention should be given to maintaining emergency (fire, etc.) vehicle, bus and mail routes. It may be appropriate to request District input, research or communication with the fire department, school authorities and other authorities concerning the maintenance of traffic patterns. Include traffic items provided by the **Regional*** Traffic Engineer.

Edgeline markings: A one foot offset should be provided between the face of traffic barriers and the edgeline marking. This provides some lateral distance for distracted or crowded drivers to maneuver if needed.

Emergency access: During construction of roadway improvements and especially one lane maintenance projects and bridge projects, construction and flagger crews should be alert to the access needs of fire, rescue and police vehicles in the vicinity. Safety of the workers and public on the project and elsewhere is of primary importance.

Glare screens: Consideration should be given to using glare screens where practical, and when sight distances will not impact merging motorists. Glare screens reduce motorists distractions to worker activity behind the traffic barrier service and may result in a better quality product since workers would not be distracted by traffic.

Also, reducing distractions will enhance safety, improve traffic flow and decrease rubber-necking.

Grades are important to consider when establishing temporary traffic control plans. Vertical and horizontal alignment must be considered. Design alternatives for the vertical and horizontal alignment of the proposed improvements should consider the temporary traffic control plans. There may be acceptable design alternatives which would improve tie-ins to existing pavement and facilitate a significantly smoother flowing sequence of construction and temporary traffic control plans. Detours, material haul roads, temporary access locations and road connections must be vertically and horizontally evaluated. Also, insure that required construction fill will not encroach on existing travel way and maintained traffic while constructing deep cuts and high fills. When sheet piling is necessary, it requires subsurface investigation.

Grading diagram coordination is important with the temporary traffic control plans. Plan the traffic plan to facilitate implementation of the grading diagram.

Guardrail laps should be switched when traffic flow is reversed for a significant length of time.

Highway advisory radio: Interstate improvements may warrant the need for highway advisory radio broadcast, to provide advanced warning to motorists that delays should be expected unless the suggested alternate route is used.

* Rev. 7/10

Impact attenuators: These are required at the introductory locations of traffic barrier service, unless the traffic barrier can be transitioned as indicated in the Virginia Work Area Protection Manual. [Standards/Special Design Section](#)* will be contacted to design the Impact Attenuators.

Lane closures: When lane closures are proposed in the traffic control and sequence of construction plan, the use of electronic arrowboards and variable message signs should be addressed. This subject is normally addressed at Field Inspection by the Traffic Engineer.

Lanes, number of: While it may not always be possible to provide the same number of lanes that were available prior to initiating construction activities, the same number of lanes should be provided during peak hours. Lane restrictions may not be appropriate during certain periods and this should be noted on the plan.

Lane shifting: Lane shifting should be designed to accommodate the operating speed for the particular work zone. When these areas are on 4 lane divided facilities and the operating speed is considerably high, the proper superelevation is imperative. Also, the adequate horizontal and vertical alignment must be available to maintain driver expectancy and should not be designed for more than a 10 mph speed reduction than that of the remainder of the work zone.

Lane widths: Adequate lane widths should be available. Geometric Design Standards in the front of Appendix A of the *Road Design Manual* specify lane widths. Lane widths should be a minimum of 11' and in minor work zones 10'. When determining lane widths, the percent of truck traffic should be considered.

Navigable streams: Advanced up and down stream signing should be provided for sportsmen, canoeist and fishermen when overhead construction activities are required for bridge placement over navigable streams.

Pavement design should incorporate existing pavement when practical. Pavement design should consider temporary markings, so proper courses may be specified at appropriate construction stages. Milling may excessively weaken existing road pavement strength, such as at bridge approaches and the Materials Division should be consulted for appropriate instructions.

Pavement markings for temporary use may be covered with the final pavement course. Details should provide for any special pavement marking requirements. Pavement marking eradication information is in [IIM LD-93](#). Temporary pavement markers should be considered to provide more positive guidance at nighttime and during inclement weather.

* Rev. 7/07

Pavement surface within the construction and detour areas should be maintained in a condition that will permit the safe movement of traffic at a reasonable speed.

Peak traffic hour work: The temporary traffic control plans* should direct the contractor not to perform work which would impede the flow of traffic during peak hours of traffic congestion, holidays, etc.

Pedestrian traffic must be maintained. The temporary traffic control plans should accommodate pedestrian traffic as well as automobile traffic, particularly in urban areas.

Phases: Engineering studies indicate work zone lengths should not exceed 0.5 mile in length. Research in work zones indicates an increase in accident rates when motorists are subjected to extended travel times adjacent to work zone activities. Consideration should be given to constructing the facility in phases containing 0.5 mile work zone lengths, where practical. There may be situations with minimal driver distractions and inconvenience where a work zone should be as much as two miles in length.

Railway crossings must be considered. Avoid designs where traffic signals, road intersections, road grades and etc. could trap vehicles on the tracks. This was also mentioned under sequence of construction.

Right of way or temporary construction easements may be required for construction or temporary detours: Sheet piling may be more economical in some situations.

Safety issues are always of paramount importance. They encompass more items when maintaining traffic through a construction site because safety of the workers is an additional element. The worker is often protected only by the barriers or other features of the temporary traffic control plans.

Shoulders: In relatively long work zone areas, the construction of an adequate shoulder is desirable, to provide lateral placement of stalled or disabled vehicles beyond the travel lanes.

Sight distance: Adequate vertical and horizontal sight distance must be maintained for safety reasons.

Signalization, temporary and permanent: Existing and proposed pole locations must be taken into account. Signal timing: When construction activities, such as resurfacing, require the closure of an existing lane, it may be necessary to lengthen the green time for that leg. This would help retain the capacity of the intersection.

* Rev. 7/08

The State Traffic Engineer is responsible for preparation of the sign, signal and lighting plans. Temporary traffic signalization may be required at some locations for construction purposes. They will require detailed plans, just as permanent signals.

Signs with variable messages: Due to terrain or inclement weather, the use of passive signing may not be enough to maintain the desired element of safety. It may be appropriate to install variable message signs to attract the driver's attention when approaching a changing traffic pattern.

State police: There may be certain roadway improvements where the worker is adjacent to motorists and there is a danger of automobile encroachment into the work area. These projects may require the participation of state police for the enforcement of posted speed limits within the work zone. See State Police Participation in [IIM LD-93](#). Interstate roadway improvements may warrant an increase in the number of existing safety patrols to reduce delays and provide assistance to stranded motorists within the travel lanes.

Stubs should be designed where appropriate to facilitate improved temporary traffic control plans* for future road extension. Pavement stubs and "tie-in" construction should be addressed in the maintenance of traffic plan.

Tapers are needed for lane drops or at locations where traffic must be shifted laterally. Appropriate values for taper lengths can be found in Part VI of the MUTCD.

Traffic volume capacity: Attempt to maintain the traffic volume capacity of existing roads.

Turn lanes should be maintain (left and right).

Utility adjustment must be accommodated.

Wrecker service: Some work zones, mainly on limited access facilities, may require the implementation of 24 hour wrecker availability for the towing of disabled vehicles.

* Rev. 7/08

NOTES WHICH MAY BE APPROPRIATE ON TEMPORARY TRAFFIC CONTROL AND SEQUENCE OF CONSTRUCTION PLANS INCLUDE:

(These notes should be developed in coordination with the **Regional*** Traffic Engineer)

Unless otherwise approved or directed by the Engineer, the contractor shall plan and prosecute the work in accordance with the following sequence of construction and temporary traffic control plans and this shall be coordinated with the bridge plans.

It is not the intent of the sequence of construction plan to enumerate every detail which must be considered in the construction of each stage, but only to show the general handling of traffic.

All areas excavated below existing pavement surface and within the clear zone, at the conclusion of each workday, shall be back filled to form an approximate 6:1 wedge, against the existing pavement surface for the safety and protection of vehicular traffic. All cost for placing, maintaining and removing the 6:1 wedge shall be included in the price bid for other items in the contract and no additional compensation will be allowed.

Traffic barrier service shall be installed and removed so as not to present any blunt end or hazard to the motoring public. The placement and removal of the traffic barrier service and barricades are to be coordinated by the Project Safety Officer.

LIMITATION OF OPERATION notes may include:

The following restrictions will apply, except in cases where the Engineer determines they are not in the best interest of the Department and/or the traveling public.

Traffic shall not be detained on route_____for longer than five minutes at any time, unless directed by the Engineer.

Closing of traffic lanes or shoulders is only permitted between 10:00 P.M. and 6:00 A.M. Monday through Friday.

No lane restrictions will be permitted from 12:00 Noon Friday until 9:00 A.M. Monday and during the following period: 6:00 A.M. Dec. 23, 2006 through 7:00 P.M. Jan. 3, 2007;

Note concerning southbound traffic may read: All travel lanes shall be open between the hours of 4:00 P.M. and 6:00 P.M. Monday through Friday. One travel lane may be closed all other times with the exception of dates listed below.

* Rev. 7/10

CONSTRUCTABILITY

Constructability relates to whether the project can be constructed as designed with the information shown in the plans. Many of the necessary items to consider when determining the constructability of a project are included in the Road Design Manual's Quality Control Checklist.

There is a huge advantage in having a construction expert review the concept of a project before even preliminary plans begin. A construction expert can review the proposed project and what it is intended to achieve, the proposed location of a project, the duration for design and construction and various design alternatives. This review should involve a dialogue with the design leaders of the project.

The construction expert will look at the proposed project through the eyes of the constructor and will consider the advantages and disadvantages of the potential design alternatives. There should be a review of the site and of the surrounding areas.

Geology, topography, accessibility, utilities, existing infrastructure, businesses, residences, etc., should be examined from the contractor's perspective. Potential strategies likely to be adopted by the contractors to deal with all these site issues should be discussed with the design team to see how the design might be developed to dovetail with strategies that are beneficial to the contractors and the local population in the prosecution of the project.

The review may go several miles beyond the environs of the project to examine access for large equipment.

There are issues that can impact design decisions and should be examine early. It provides the opportunity for the designer to begin design with certain key issues in mind which can frequently be accommodated in the design without adverse cost impact to the design. It is not that constructability issues drive the design but that design accommodates constructability in its evaluation. This is much better than trying to inject constructability into the design later.

The construction expert should have a broad knowledge of construction in several fields, not just highways and bridges, together with an understanding of, and empathy with, both the designer and the constructor. Constructability is more than simply making life easier for the contractor. It is the incorporation of construction expertise into the design process so that it will meet all of the design requirements, including aesthetics, at the lowest reasonable cost of construction.

Deleted Information*

* Rev. 7/06

A construction expert will have this broad expertise, together with the ability to work cooperatively and sympathetically with the design team and to respect the integrity of their design. In this way, the constructability review process becomes a team operation where the constructability resource and the design team work together cooperatively to integrate constructability into the design process.

ITEMS TO BE ADDRESSED UNDER CONSTRUCTABILITY INCLUDE:

Access to adjacent residential and commercial properties should be maintained at all times.

Contractor operations: Adequately evaluate and explain appropriate construction task and operations. This may include the order of construction activities.

Drainage issues: Drainage network errors have had the largest dollar impact and account for 25% of total errors on plans; last minute design changes to the roadway plans, which often require adjustments to the drainage plans, caused many of these errors. Check inverts of culverts and systems to insure positive drainage and outfall. Utility conflicts can significantly affect the sequence of construction. Address the need for temporary drainage for construct, detours, slope drains, etc. (IIM LD-11).

Easements and right of way must be sufficient to construct Project. Few issues can cause more construct delay than the lack of necessary easements or right of way.

Environmental issues: These are issues that can cause more construction delay or unexpected cost. Environmental Division representatives will provide guidance on these issues such as permits required for construction in live streams or concerning wetlands.

Equipment necessary such as piers, cranes, etc.: Adequate equipment clearance such as a crane swing radius is a constructability issue, for safety and functional reasons. Large equipment deserves special consideration as to how it will be transported to the job site and to provide adequate maneuvering clearance during construction. The Construction Division is a source for advice.

Excavation near existing structures: One issue may be a question of providing adequate horizontal distance to maintain the integrity of existing structures. A subsurface investigation may be appropriate for some locations. The Construction Division is a source for advice.

Materials supply: Consider where and how materials may be supplied to the project. Consider what form of transportation may be utilized to transport material to the job site.

Picture how each aspect of the project will be constructed from the beginning as it would look in the field rather than from plan view.

Plan information: Provide comprehensive plan information for construction of the project.

Plan views, profiles and cross sections must agree.

Precast versus cast-in-place structures should be addressed when appropriate.

Quantity summaries must be complete.

Right of way and easements must be adequate to construct project, store material and operate equipment. Signing, lighting, signalization and other issues present possible needs for additional easements or right of way.

Utility conflicts and relocations can significantly affect project construction schedules.

REFERENCES:

Guidance concerning sequence of construction, temporary traffic control plans* and their impact on constructability are found in the following references:

Road Design Manual:

| | |
|-------|--|
| 1E-1 | Quality Control and Checklist |
| 2D-22 | Pavement Termination |
| I-2 | Traffic Barriers - Guardrail and Concrete Barriers |
| 2E-81 | Safety Items and Sequence of Construction |
| 2G-24 | Temporary Diversion |

* Rev. 7/08

Instructional and Informational Memoranda:

- LD-11 Erosion and Sediment Control, construction entrances
- LD-93 Construction Zone Safety
- LD-213 Pavement Markings, Construction Signs, Type III Barricades, Insertable Sheets to be included in applicable plan assemblies
- LD-241 Work Zone Safety and Mobility

Road and Bridge Specifications:

Section 104, Scope of Work and Section 107, Legal Relations and Responsibility to the Public

The Federal Highway Administration's [*Manual on Uniform Traffic Control Devices*](#), MUTCD

[*The Virginia Supplement to the Manual on Uniform Traffic Control Devices*](#)

[*The Virginia Work Area Protection Manual*](#) replaces Part VI of the [*Virginia Supplement to the Manual on Uniform Traffic Control Devices*](#)

SEQUENCE OF CONSTRUCTION AND TEMPORARY TRAFFIC CONTROL ITEMS TO CONSIDER

A. SEQUENCE OF CONSTRUCTION

(Items to Consider)
 Adjoining projects
 Bridge construction
 Construction activity
 Drainage
 Environmental concerns
 Excavation and earthwork
 Example plans

Deleted Information*

* Rev. 7/14

Funeral homes and Churches
Intersection reconstruction
Material hauls
Nighttime construction
Note in the plans
Pavement demolition
Railroad crossings
Sound barrier walls
Time of day, holidays or other time restrictions
Utilities
Walk the project; take notes, make sketches and take pictures and videos.

B . TEMPORARY TRAFFIC CONTROL*

(Items to Consider)

Access to adjacent properties
Asphalt medians, temporary
Barrier and attenuator service
Bridge rails, existing
Clear zone
Construction equipment
Coordinate work
Detours
Edgeline markings
Emergency access
Glare screens
Grades
Grading diagram
Guardrail laps
Highway advisory radio
Impact attenuators
Lane closures
Lanes, number
Lane shifting
Lane widths
Navigable streams
Pavement design
Pavement markings
Pavement surface

* Rev. 7/08

TEMPORARY TRAFFIC CONTROL*

(Items to Consider)

-continued-

Peak traffic hour work
Pedestrian traffic
Phases
Railroad crossings
Right of way and easements
Safety issues
Shoulders
Sight distance
Signalization
Signs with variable messages
State police
Stubs
Tapers
Temporary grade separation
Traffic volume capacity
Turn lanes
Utility adjustment
Wrecker service

C. CONSTRUCTABILITY

(Items to Consider)

Contractor operations
Drainage
Easements and right of way
Environmental
Equipment
Excavation
Materials
Picture each aspect
Plan
Plan/profiles/cross sections agree
Precast versus cast-in-place
Quantity summaries
Signing, lighting, signalization
Utility conflicts

* Rev. 7/08