

PLAN VIEW ANCHOR SLAB TYPE I

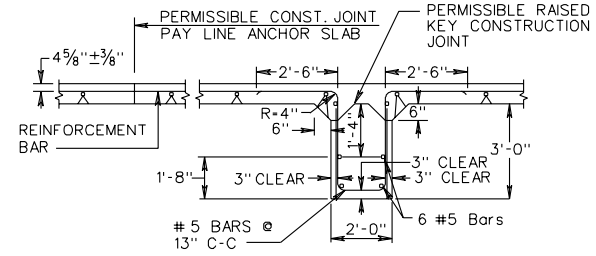

SECTION D-D

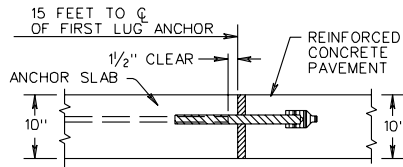

SECTION E-E ANCHOR SLAB TYPE I

FOR DOWEL & JOINT DETAILS SEE DETAIL OF TRANSVERSE EXPANSION JOINT PR-2

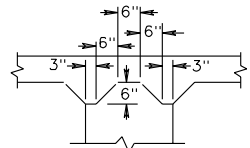

DETAIL-RAISED KEY CONSTRUCTION JOINT

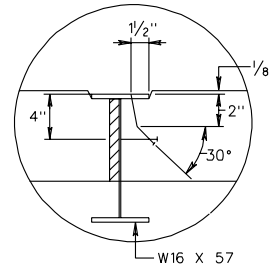

DETAIL A

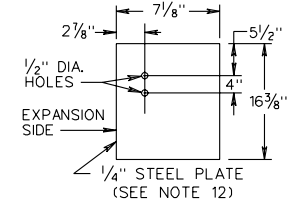

ANCHOR SLAB TYPE II END PLATE DETAIL

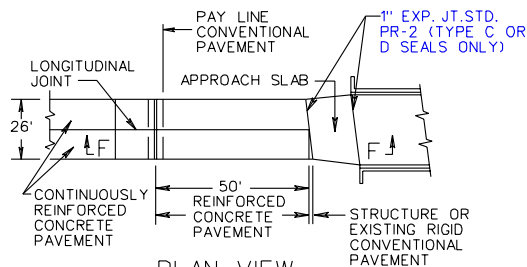

PLAN VIEW ANCHOR SLAB TYPE II (SEE NOTE 11)

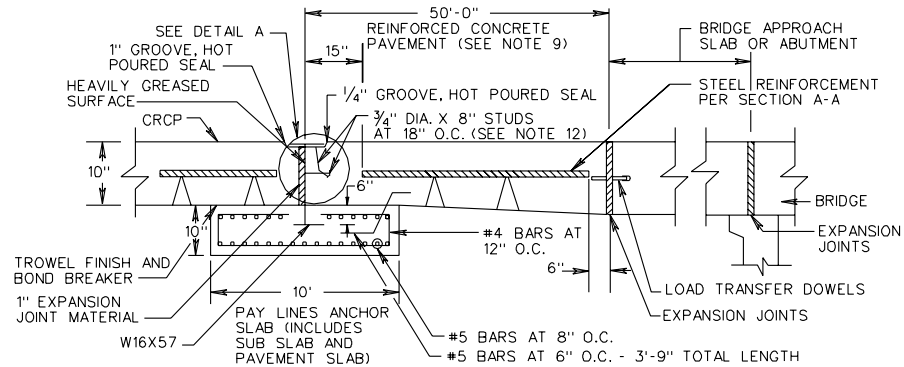

SECTION F-F ANCHOR SLAB TYPE II

SEE SHEET 3 OF 3 FOR NOTES

SHEET 2 OF 3

SPECIFICATION REFERENCE	<p>10" THICK CONTINUOUSLY REINFORCED CONCRETE PAVEMENT 14 FOOT TRAVEL LANE</p> <p>VIRGINIA DEPARTMENT OF TRANSPORTATION</p>	REV. 7/03
316		301.17