

PLAN VIEW ANCHOR SLAB TYPE I

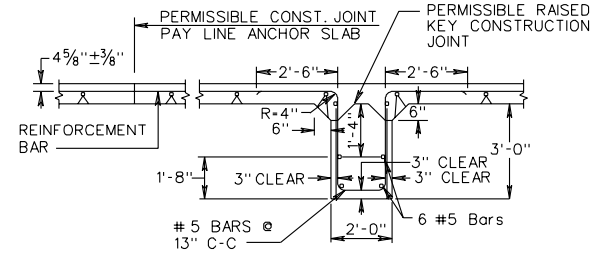

SECTION D-D

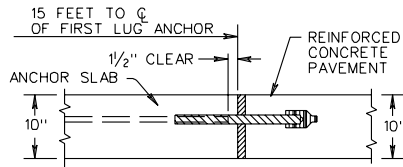

SECTION E-E ANCHOR SLAB TYPE I

FOR DOWEL & JOINT DETAILS SEE DETAIL OF TRANSVERSE EXPANSION JOINT PR-2

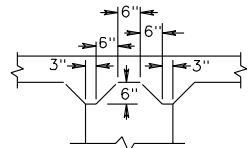

DETAIL-RAISED KEY CONSTRUCTION JOINT

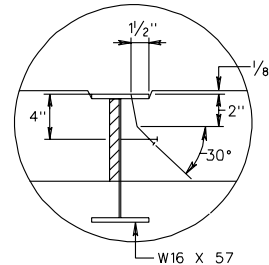

DETAIL A

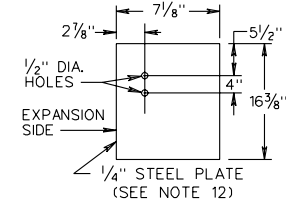

ANCHOR SLAB TYPE II END PLATE DETAIL

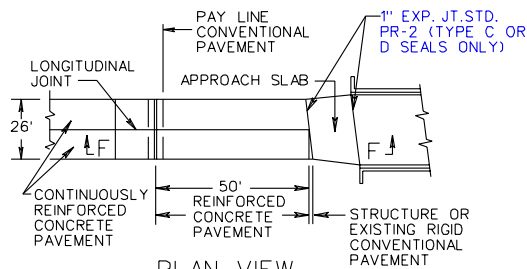

PLAN VIEW ANCHOR SLAB TYPE II (SEE NOTE 11)

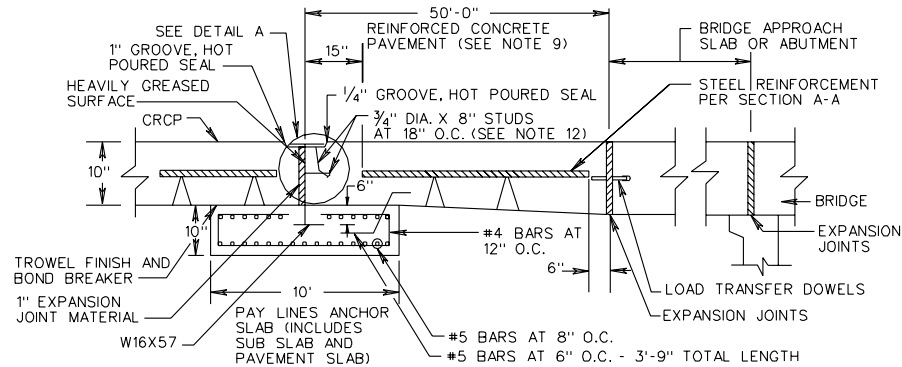

SECTION F-F ANCHOR SLAB TYPE II

SEE SHEET 3 OF 3 FOR NOTES

SHEET 2 OF 3

|                         |   |           |
|-------------------------|---|-----------|
| SPECIFICATION REFERENCE | <p>10" THICK CONTINUOUSLY REINFORCED CONCRETE PAVEMENT<br/>14 FOOT TRAVEL LANE</p> <p>VIRGINIA DEPARTMENT OF TRANSPORTATION</p> | REV. 7/03 |
| 316                     |   | 301.17    |