

PLAN VIEW
ANCHOR SLAB TYPE I

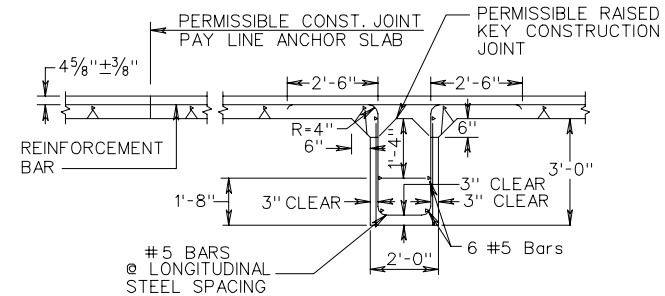

SECTION D-D

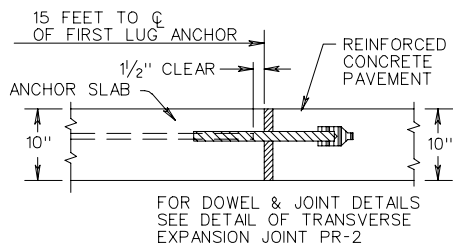

SECTION E-E
ANCHOR SLAB TYPE I

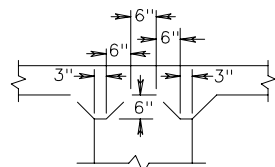

DETAIL-RAISED KEY
CONSTRUCTION JOINT

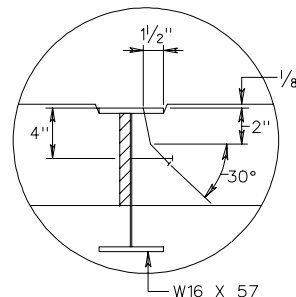

DETAIL A

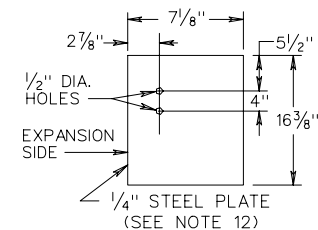

ANCHOR SLAB TYPE II
END PLATE DETAIL

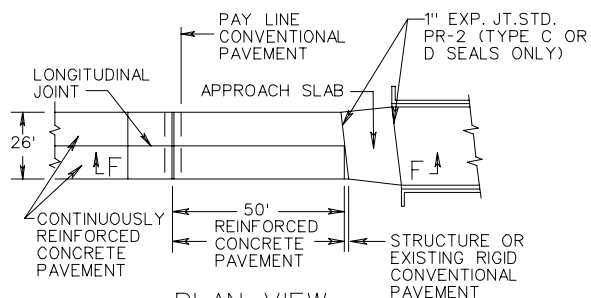

PLAN VIEW
ANCHOR SLAB TYPE II
(SEE NOTE 11)

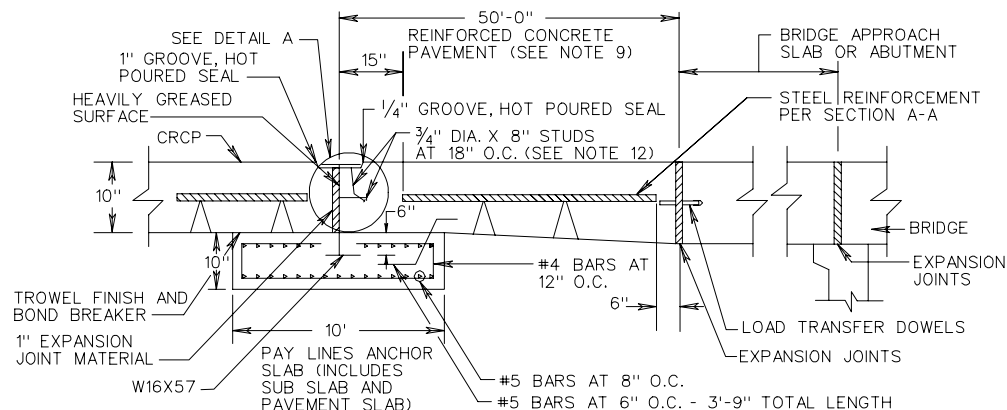

SECTION F-F
ANCHOR SLAB TYPE II

SEE SHEET 3 OF 3 FOR NOTES

SHEET 2 OF 3

SPECIFICATION REFERENCE	10" THICK CONTINUOUSLY REINFORCED CONCRETE PAVEMENT 14 FOOT TRAVEL LANE
316	VIRGINIA DEPARTMENT OF TRANSPORTATION
	REV. 1/04 301.17