

DI-4A,4B,4C

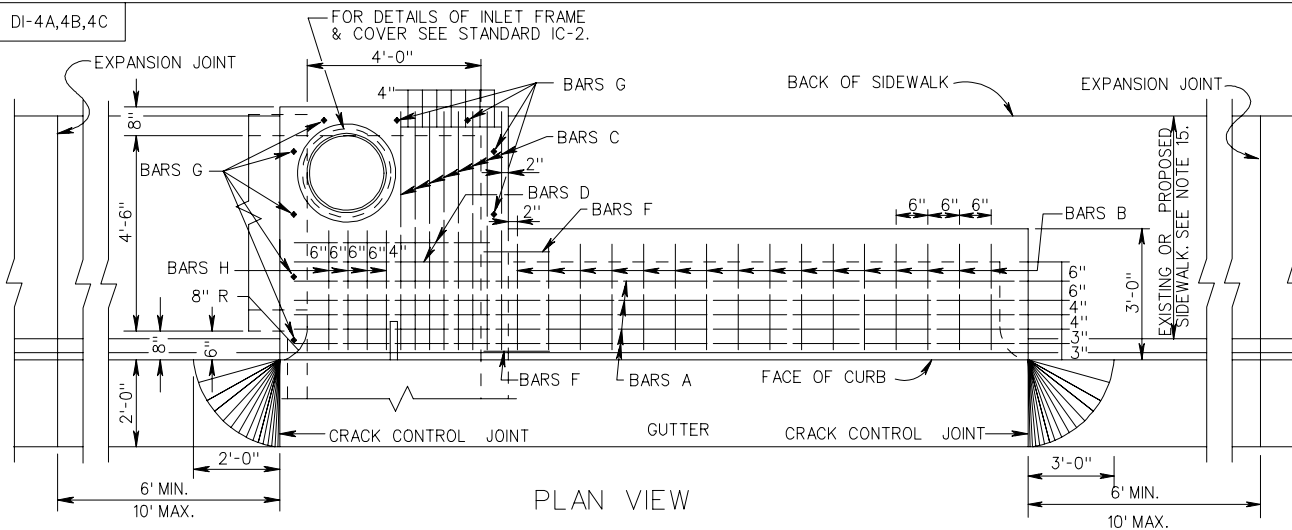

GALVANIZED PLATE TO BE BENT ON AN ANGLE OF 68° 30' AND IS TO BE ANCHORED WITH 1/2" X 4" STUD SHEAR CONNECTORS WELDED TO BENT PLATE AT 2'-0" C-C.

TYPE A NOSE DETAIL SHALL BE USED WITH CG-3 AND CG-7 STANDARDS. TYPE B NOSE DETAIL SHALL BE USED WITH CG-2 AND CG-6 STANDARDS.

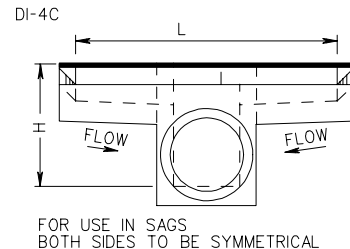
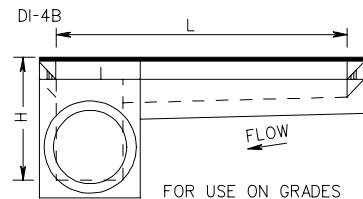
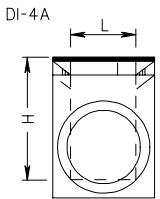
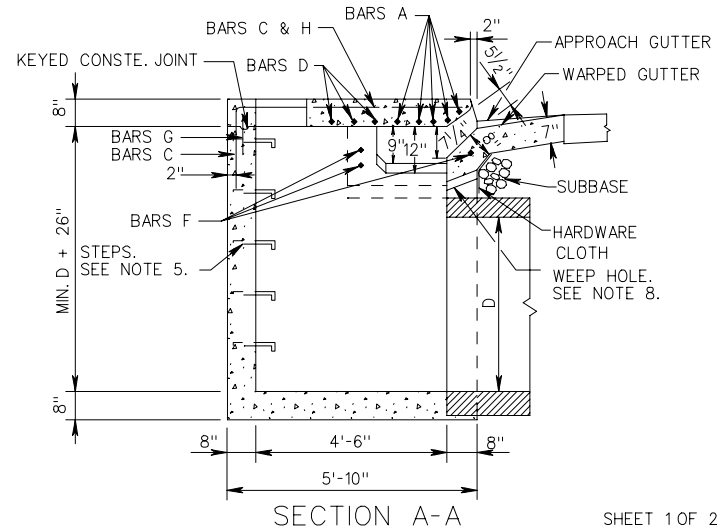
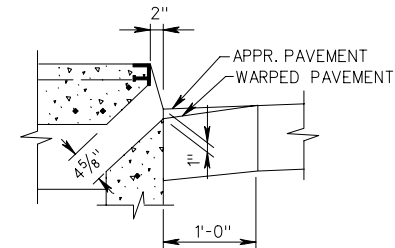
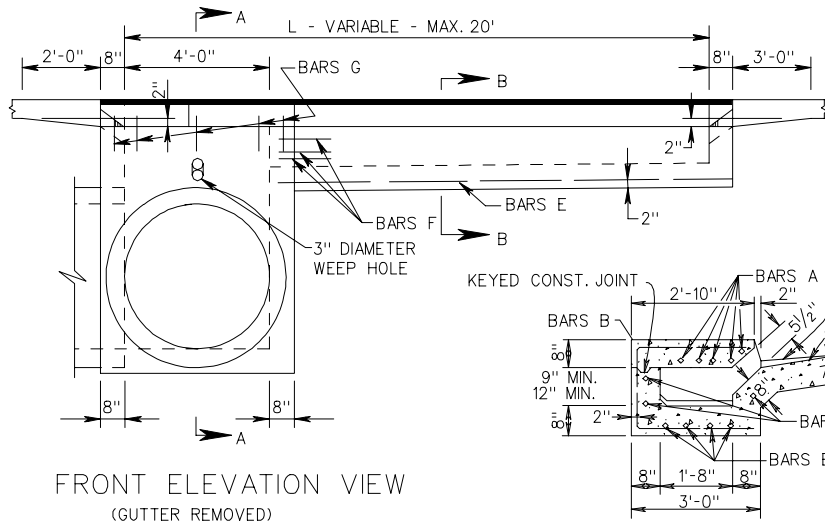
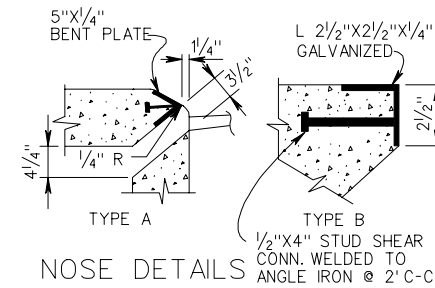

STANDARD CURB DROP INLET
36" - 48" PIPE: MAXIMUM DEPTH (H) = 8'

SPECIFICATION REFERENCE

233
302