

NOTE:  
LAP IN DIRECTION OF TRAFFIC AT SPLICE JOINT.

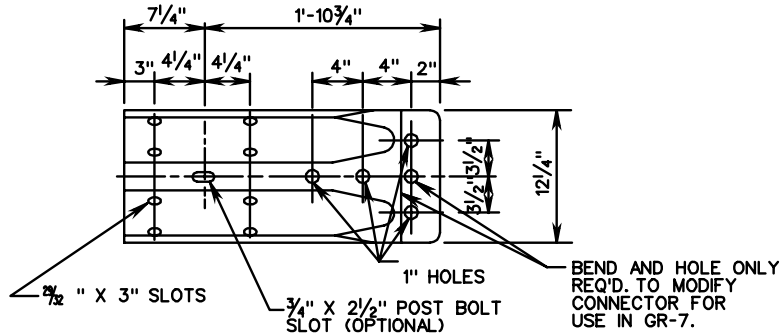

W BEAM TERMINAL CONNECTOR

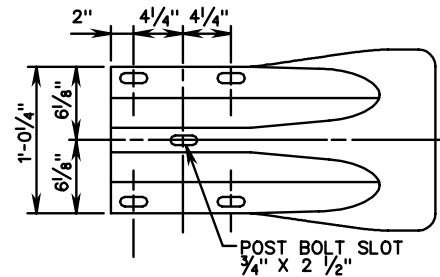
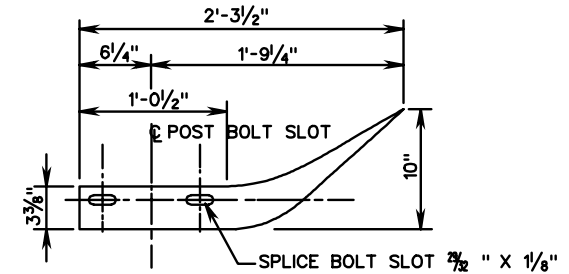

W BEAM END SECTION (FLARED)

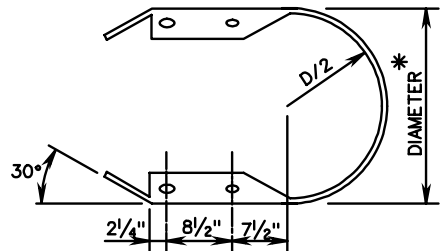

\* THE GUARDRAIL MEDIAN BARRIER COMPONENTS DEPICTED IN A.R.T.B.A. TECHNICAL BULLETIN NUMBER 268B MAY BE SUBSTITUTED IF INTERCHANGEABLE WITH THE STANDARDS FOR GUARDRAIL (GR) OR MEDIAN BARRIER (MB) AND APPROVED BY THE ENGINEER.

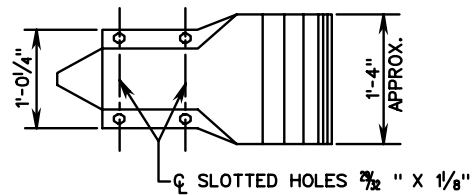
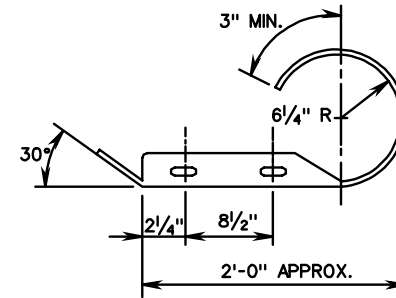

\* STANDARD DIMENSIONS OF 12 1/2", 24" AND 30" ARE SUGGESTED.

W BEAM END SECTION (BUFFER)

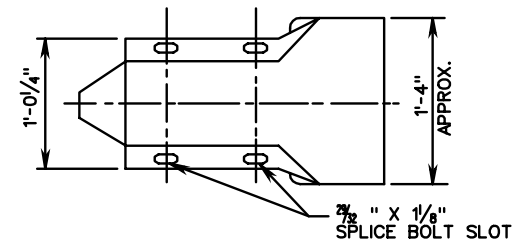

W BEAM END SECTION (ROUNDED)

SPECIFICATION REFERENCE

221  
505

STANDARD GUARDRAIL HARDWARE  
W BEAM GUARDRAIL HARDWARE

VIRGINIA DEPARTMENT OF TRANSPORTATION