

PLAN VIEW
ANCHOR SLAB TYPE I

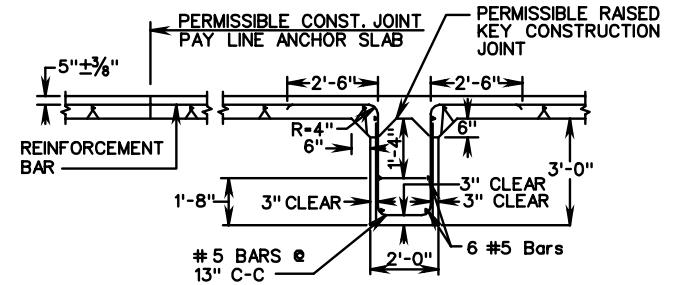

SECTION D-D

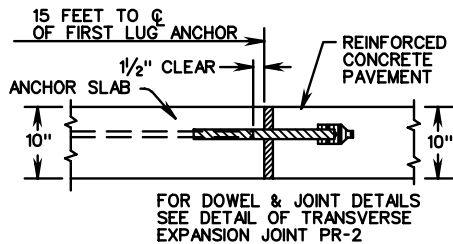

SECTION E-E
ANCHOR SLAB TYPE I

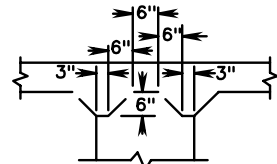

DETAIL-RAISED KEY
CONSTRUCTION JOINT

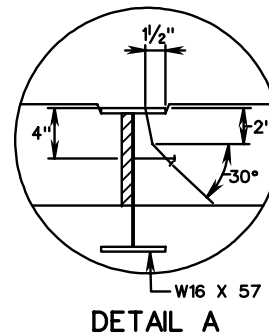

DETAIL A

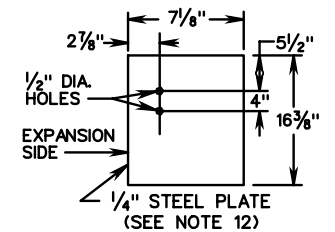

ANCHOR SLAB TYPE II
END PLATE DETAIL

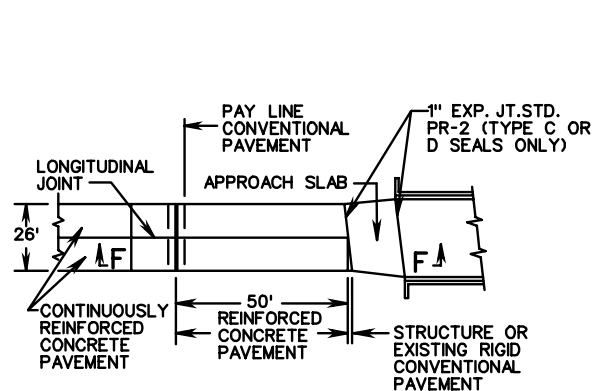

PLAN VIEW
ANCHOR SLAB TYPE II
(SEE NOTE 11)

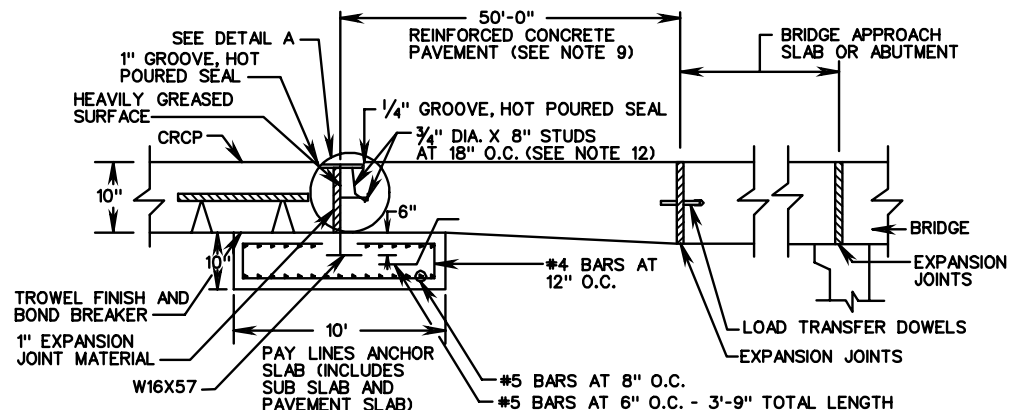

SECTION F-F
ANCHOR SLAB TYPE II

SEE SHEET 3 OF 3 FOR NOTES

SHEET 2 OF 3

<p>SPECIFICATION REFERENCE</p> <p>316</p>	<p>10" THICK CONTINUOUSLY REINFORCED CONCRETE PAVEMENT</p> <p>14 FOOT TRAVEL LANE</p> <p>VIRGINIA DEPARTMENT OF TRANSPORTATION</p>	<p>301.17</p>
---	--	---------------