

NOTES:

NO SEPARATE PAYMENT WILL BE MADE FOR FURNISHING, INSTALLING AND PROVIDING MAINTENANCE OF THE STORAGE FACILITY FOR NUCLEAR GAUGE AND THE PRICE THEREOF SHALL BE INCLUDED IN THE PRICE BID FOR FIELD OFFICE (TYPE) SPECIFIED, IN ACCORDANCE WITH SECTION 514 OF THE CURRENT ROAD AND BRIDGE SPECIFICATIONS.

BOX TO BE CONSTRUCTED OF A-36 SHEET STEEL 1/8" MIN. THICKNESS. WHEN WELDING TO FRAME USE 1/8" FILLET WELDS.

ALL FRAME WORK IS TO BE A-36 STEEL ANGLE L 2" X 2" X 1/4".

ALL FRAME WELDS ARE TO BE 1/4" FILLET OR BUTT WELDED ACCORDINGLY.

METAL SCREEN SHALL HAVE A MAXIMUM OF 50 SQUARES PER INCH TO A MINIMUM OF 25 SQUARES PER INCH AND BE SPOT WELDED TO INSIDE OF THE BOX OVER VENT OPENINGS.

△ THE HOOK SHALL BE WELDED TO THE CENTER OF THE TOP. VENT OPENINGS SHALL BE PARTIALLY COVERED EXTERNALLY BY METAL VENT COVERS.

STORAGE UNIT SHALL BE PAINTED INTERNALLY AND EXTERNALLY WITH A ONE COAT ACRYLIC DIRECT TO METAL (DTM) COATING, WITH A THICKNESS OF 4-6 MILS (WET MIL THICKNESS). COLOR SHALL BE EQUAL TO FEDERAL STANDARD COLOR NO. 595-17886 (WHITE).

THE DESIGN IS TO BE 4" ID AND MOUNTED AT A 45° ANGLE OVER THE HASP OPENING IN THE DOOR. OPTIONAL SHROUD DESIGN IS TO BE SUBMITTED FOR THE ENGINEERS REVIEW AND APPROVAL.

CONTRASTING PAINT IS REQUIRED TO DEPICT STORAGE AREA.

STORAGE UNIT TO HAVE TWO (2) TAMPER-RESISTANT HASPS WITH A LOCK BOX EACH, OPEN ON THE BOTTOM AND TOP.

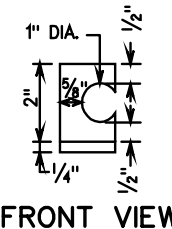
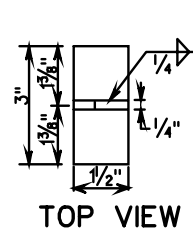
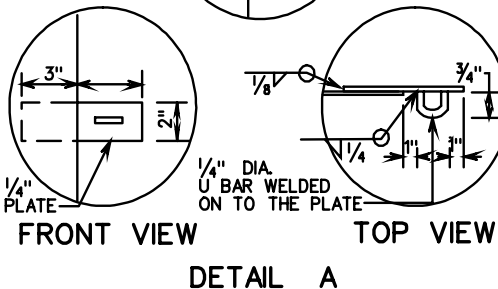
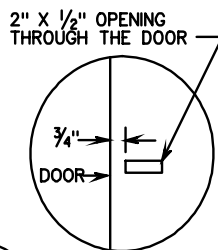
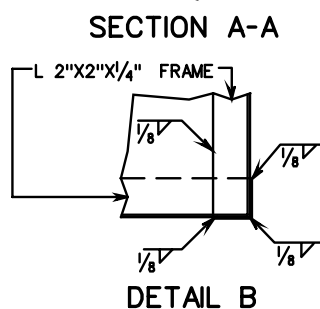
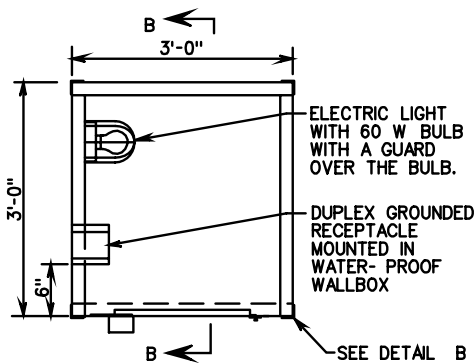

DETAIL E

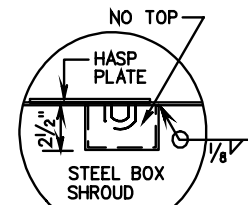

TOP VIEW

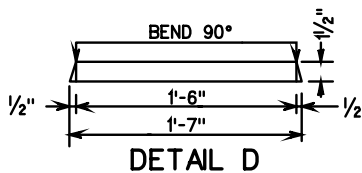

DETAIL D

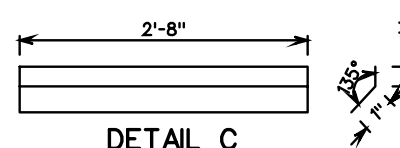

DETAIL C

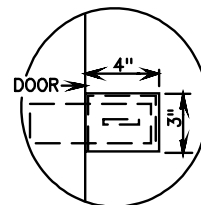

FRONT VIEW

DETAIL F

SPECIFICATION REFERENCE

STORAGE FACILITY FOR NUCLEAR GAUGE

VIRGINIA DEPARTMENT OF TRANSPORTATION

VDOT

ROAD AND BRIDGE STANDARDS

REVISION DATE

SHEET 1 OF 1

605.01