

GR-FOA-4

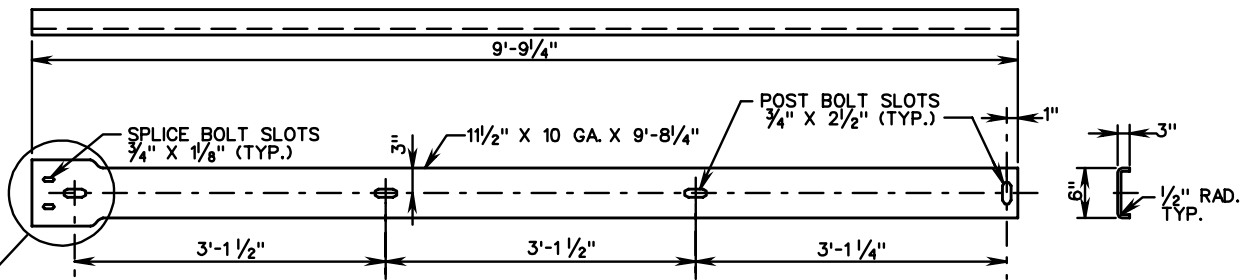

ITEM ⑦ DETAIL

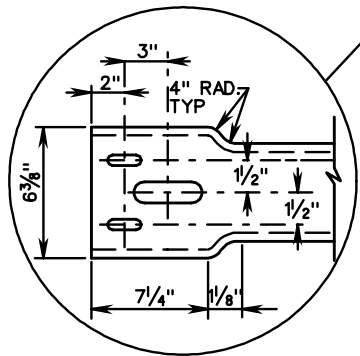

NOTES:

1. CAN BE FIELD CUT AND BENT USING HEAT. IF SHOP CUT AND BENT, RIGHT HAND OR LEFT HAND MUST BE SPECIFIED, DEPENDING ON WHICH SIDE OF THE ROADWAY THE TRANSITION IS USED.

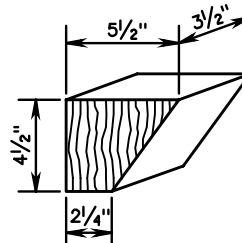

ITEM ⑨ DETAIL

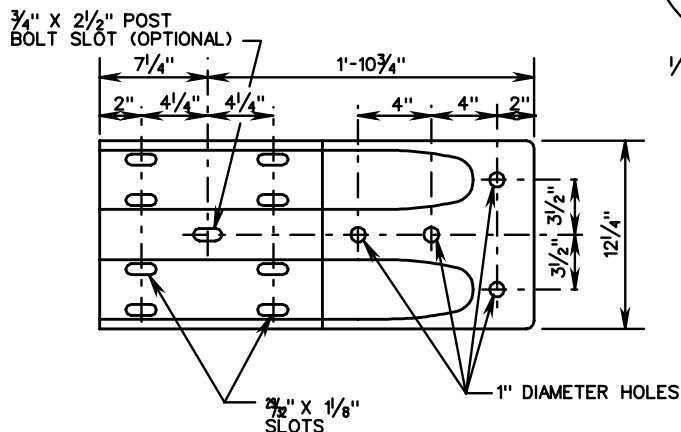
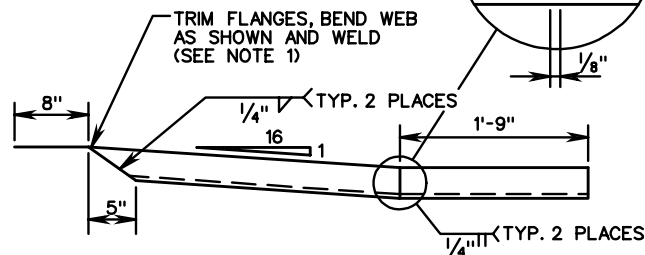
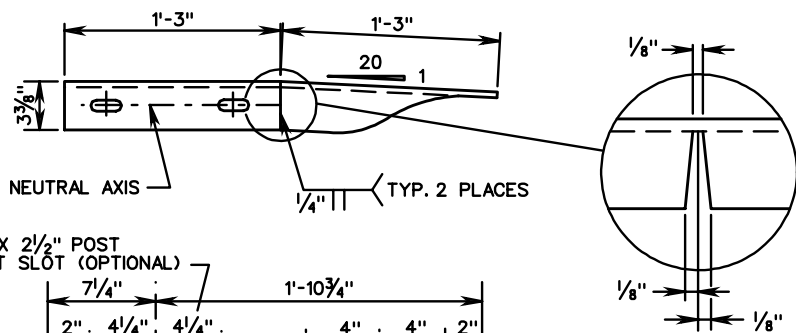
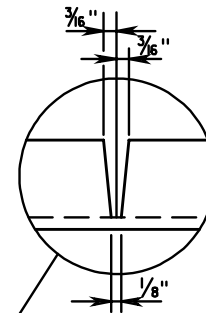

W BEAM TERMINAL CONNECTOR (MOD.)

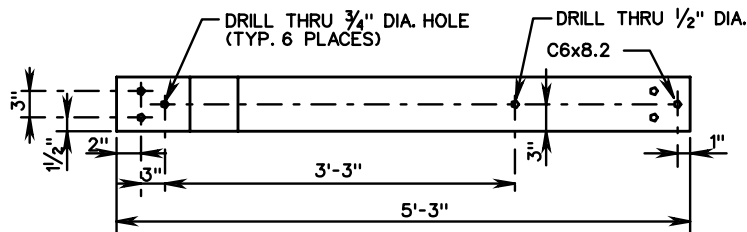

ITEM ⑧ DETAIL



ROAD AND BRIDGE STANDARDS

**BLOCKED-OUT W-BEAM MEDIAN BARRIER
FIXED OBJECT ATTACHMENT**
(RUBRAIL AND HARDWARE DETAILS)
VIRGINIA DEPARTMENT OF TRANSPORTATION

SPECIFICATION
REFERENCE

SHEET 2 OF 2

REVISION DATE

505

501.32