

WF&C-1

4 7/8" CORED HOLES C 90°

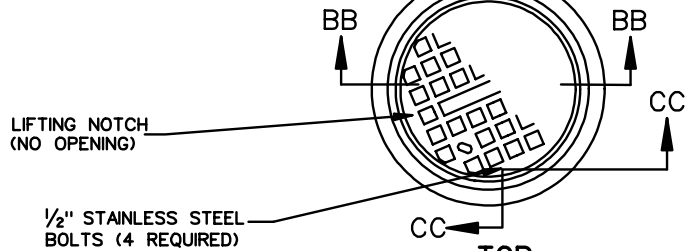

APPROXIMATE WEIGHTS

| | | |
|-------|-------|---------|
| FRAME | 220 ± | 11 LBS. |
| COVER | 260 ± | 13 LBS. |
| TOTAL | 480 ± | 24 LBS. |

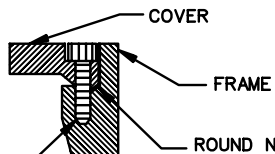
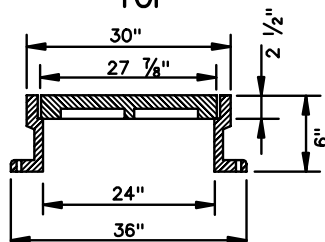

1. DETAILS NOT SHOWN ARE AS REQUIRED FOR ST'D F&C-1 M.H. FRAME AND COVER.
2. FRAME SHALL BE SET IN 1/4" BED OF NON-SAG JOINT SEALER & BOLTED TO THE MANHOLE CONE SECTION WITH 4 3/4" ANCHOR BOLTS.
3. CAST IRON SHALL CONFORM TO ASTM A-48, CLASS 30S.
4. SEATING SURFACES BETWEEN FRAME AND COVER SHALL BE MACHINED.
5. 1/4" x 1" CONTINUOUS NEOPRENE GASKET SHALL BE INSTALLED BETWEEN THE INNER COVER AND THE FRAME.
6. RECESSED PICK HOLE SHALL NOT EXTEND THRU THE COVER.

WATERTIGHT MANHOLE FRAME AND COVER

F&C-1

CAST IRON COVER MARKED "SEWER" OR "WATER" AS APPLIES.

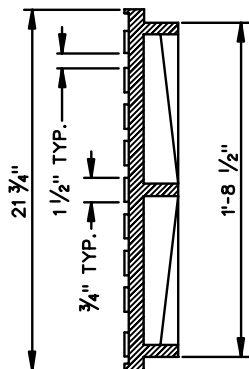

APPROXIMATE WEIGHT

| | | |
|-----------------|-------|---------|
| CAST IRON FRAME | 239 ± | 12 LBS. |
| COVER | 137 ± | 7 LBS. |

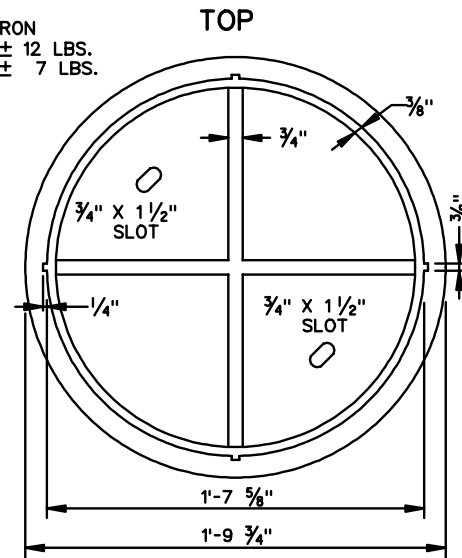
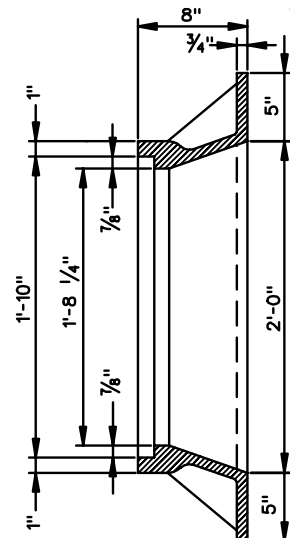
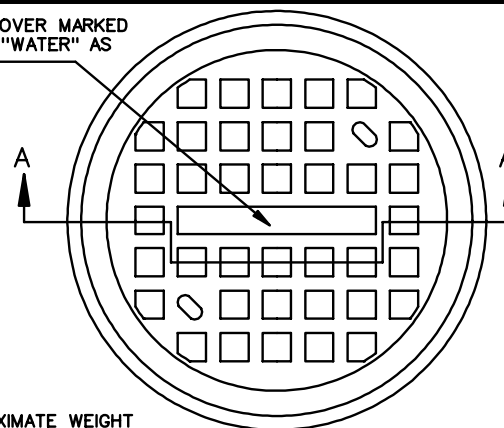

NOTES:

1. CAST IRON SHALL CONFORM TO ASTM A-48M, CLASS 30S.
2. CASTING AND FRAME ARE TO BE MACHINED TO ENSURE A FIRM TIGHT FIT.
3. DIMENSIONS NOT SHOWN ARE THE SAME AS STANDARD MH-1 FRAME AND COVER.

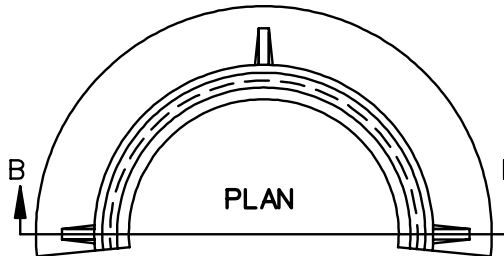

MANHOLE FRAME AND COVER

WATER AND SANITARY SEWER FACILITIES

VIRGINIA DEPARTMENT OF TRANSPORTATION