

**APPENDIX B(1) – SUBDIVISION STREET DESIGN GUIDE  
(EFFECTIVE JULY 1, 2009)**

**SECTION B(1) – 1 – INTRODUCTION**

Introduction ..... B(1)-1

**SECTION B(1) – 2 – DESIGN REQUIREMENTS**

Projected Traffic/Capacity Analysis..... B(1)-2  
Functional Classification ..... B(1)-2  
Terrain ..... B(1)-4

**SECTION B(1) – 3 – ROADWAY GEOMETRIC DESIGN CRITERIA**

A. Collector and Arterial Roadways ..... B(1)-5  
B. Local Roadways ..... B(1)-5  
C. Transitions and Turn Lanes..... B(1)-6  
D. Sight Distance ..... B(1)-19

**SECTION B(1) – 4 – ELEMENTS OF TYPICAL SECTION**

A. Pavement Design ..... B(1)-21  
B. Pavement Width ..... B(1)-21  
C. Parking Lane Widths (Curb and Gutter Only)..... B(1)-21  
D. Intersections ..... B(1)-21  
E. Concentric Design ..... B(1)-23  
F. Cul-de-sacs and Turnarounds ..... B(1)-23  
G. Curb And Gutter Design ..... B(1)-26  
H. Private Entrances ..... B(1)-28  
I. Pedestrian And Bicycle Facilities ..... B(1)-31  
J. Bridge and Culvert Design Criteria ..... B(1)-36  
K. Roadway Drainage ..... B(1)-37  
L. Right-of-way ..... B(1)-39

**SECTION B(1) – 5 – OTHER DESIGN CONSIDERATIONS**

A. Clear Zone (i.e. Setback for non-breakaway fixed objects)..... B(1)-40  
B. Guardrail ..... B(1)-42  
C. Traffic Control..... B(1)-42  
D. Streetscape ..... B(1)-42  
E. Landscape Considerations ..... B(1)-43  
F. Traffic Calming ..... B(1)-46  
G. Roundabouts ..... B(1)-48  
H. Utilities ..... B(1)-50  
I. Roadway Lighting ..... B(1)-52

**SECTION B(1) – 6 – TRADITIONAL NEIGHBORHOOD DESIGN ..... B(1)-54**

**SECTION B(1) – 7 – INNOVATIVE DESIGN PROPOSALS ..... B(1)-56**

## List of Figures

Figure 1 – "Exhibit 2-4" Scanned From "A Policy On Geometric Design Of Highways And Streets," AASHTO, 2004.....	B(1)-5
Geometric Design Standards For Residential And Mixed Use Subdivision Streets (Gssr) Table 1– Curb And Gutter Section.....	B(1)-7
Geometric Design Standards For Residential And Mixed Use Subdivision Streets (Gssr) Table 2 – Shoulder And Ditch Section .....	B(1)-8
Geometric Design Standards For Residential And Mixed Use Subdivision Streets (Gssr) Table 3 – One-Lane (One-Way) Subdivision Streets.....	B(1)-9
Figure 1.1 – 24' Curb To Curb No Parking / Parking On One Side .....	B(1)-10
Figure 1.2 – 29' Curb To Curb Parking On Both Sides.....	B(1)-11
Figure 1.3 – 36' Curb To Curb Parking On Both Sides.....	B(1)-12
Figure 1.4 – 29' Curb To Curb Parking On Both Sides.....	B(1)-13
Figure 1.5 – 24' Outside Width Parking One Side .....	B(1)-14
Figure 1.6 – 29' Outside Width Parking On Both Sides.....	B(1)-15
Figure 1.7 – 36' Outside Width Parking On Both Sides.....	B(1)-16
Figure 1.8 – 29' Stabilized Shoulder And Ditch With Ribbon Curb .....	B(1)-17
Table 4 – School Bus Access Road .....	B(1)-18
Figure 2 – Sight Distance Triangles .....	B(1)-20
Figure 3 – Intersection Design .....	B(1)-22
Figure 4 – Cul-De-Sac Details.....	B(1)-25
Figure 5 – Curb And Gutter Details .....	B(1)-26
Figure 6 – Detail Back Of Curbs.....	B(1)-28
Figure 7 – Roll Top Curb Entrance Detail.....	B(1)-29
Figure 8 – Rolltop Curb Entrance Detail Section .....	B(1)-29
Figure 9 – Private Entrance Detail .....	B(1)-30
Table 5 – Maximum Grade Lengths For Shared Use Paths.....	B(1)-34
Figure 10 – Setback Details With Curb And Gutter .....	B(1)-41
Figure 11 – Setback Details With Shoulder And Ditch .....	B(1)-41
Figure 12 – Traffic Calming Details .....	B(1)-47
Figure 13 – Roundabout Details.....	B(1)-50
Figure 14 – Lighting Along Curb And Gutter Sections.....	B(1)-53
Figure 15 – Lighting Along Shoulder And Ditch Sections.....	B(1)- <b>Error! Bookmark not defined.</b>

## APPENDIX B(1) – SUBDIVISION STREET DESIGN GUIDE

### SECTION B(1) – 1 – INTRODUCTION

#### INTRODUCTION

This document is an appendix of VDOT's Road Design Manual and is intended for users of VDOT's Secondary\* Street Acceptance Requirements for the development of new residential and mixed-use streets functionally classified as "local" streets. All other streets must be developed in accordance with appropriate provisions of the Road Design Manual for the appropriate functional classification.

For the purposes of this document, "District Administrator's Designee" means that employee who oversees the land development functions in a particular geographic area. This may be the Residency Administrator, area engineer or that employee designated to perform the "responsible charge" duties for land development as designated by the District Administrator. In cities or towns choosing to use this design guide for the design of their subdivision streets, it means the local official responsible for the review and approval of subdivision street design.

In the event of conflict between this Appendix and other provisions of the Road Design Manual and Road and Bridge Standards, the District Administrator's Designee shall determine the governing provision. As indicated in the Secondary Street Acceptance Requirements, any requirements of the subdivision ordinance of the locality that are not in conflict with these requirements shall govern. The District Administrator's Designee is provided considerable discretionary authority in the application of standards related to local subdivision streets.

The district administrator is authorized to consider and render a decision on unresolved issues between the developer and the District Administrator's Designee that pertain to the interpretation and application of this appendix. All appeals shall be made in writing describing the unresolved issue and include copies of all prior relative correspondence.

All land development proposals should be submitted to the local jurisdiction, which will then coordinate with the District Administrator's Designee for VDOT review and approval. The District Administrator's Designee will coordinate with other VDOT sections as needed.

---

\* Rev. 3/09

## **SECTION B(1) – 2 – DESIGN REQUIREMENTS**

### **PROJECTED TRAFFIC/CAPACITY ANALYSIS**

For the purposes of these requirements, "projected traffic" includes the traffic resulting from the complete development of all land to be served by the subject roadway facility, including traffic forecast to be generated by development, both internal and external, to the site under consideration.

Traffic generation developed to meet Chapter 527 (Traffic Impact Analysis Regulations) may be utilized to meet this requirement, at the engineer of record's\* discretion. The basis for this forecast will be the governing body's current comprehensive plan or other available information pertinent to the permitted land use and transportation planning for the site and adjacent properties. The trip generation rates in the current version of Trip Generation, published by the Institute of Transportation Engineers (ITE) should be utilized in determining the projection of traffic. The ITE trip generation rate for a single-family detached residential dwelling unit is currently 10 vehicle trips per day. The use of other bona fide traffic studies in determining projected traffic for all types of land development may be considered, subject to their submission for review and approval by the Department.

As an alternative to the application of the projected traffic to the applicable geometric design criteria of these requirements, the Department will consider secondary street design based on a capacity analysis concept provided:

1. The governing body permits the utilization of this concept in the design of subdivision streets in the county, city or town.
2. The developer furnishes full rationale, to support the recommendations of this analysis. The submission should include all pertinent traffic data and computations affecting the design proposal for the streets involved.
3. An acceptable level of service should be accommodated in the street design proposed under the capacity analysis concept. A minimum level of service "D" as defined by the Highway Capacity Manual is generally acceptable for the design of local streets. To maintain an acceptable level of service, additional travel lanes, channelized roadways, etc., may be required.

### **FUNCTIONAL CLASSIFICATION**

The characteristics and magnitude of the service to be provided will be the basis for the Department's determination of the functional classification for each subdivision street intended for acceptance into the secondary system. AASHTO's Geometric Design of Highways and Streets provides guidance in the classification of roads.

---

\* Rev. 7/09

The hierarchy of the functional systems consists of principal arterials (for main movement), minor arterials (distributors), collectors and local roads and streets.

Local streets are defined as those streets that provide direct access to adjacent land and serve travel of short distances as compared to the higher systems. Most subdivision streets fall in the Local Street classification. The geometric design standards contained in this guide shall\* be used for all new residential and mixed-use streets functionally classified as "local" roads. All other street classifications should use VDOT's Road Design Manual for geometric design.

1. **Criteria**

Urban and rural areas have fundamentally different characteristics. Consequently, urban and rural functional systems are classified separately. Most subdivision streets function similar to an urban area; therefore, the urban classification can be used for high-density development with the concurrence of the locality and District Administrator's Designee.

2. **Procedures**

The Department's concurrence of the functional classification for each street within a subdivision should be made prior to departmental approval of a subdivision concept plan. To facilitate the effective development of the plats or plans and permit an expeditious review, this concurrence is recommended prior to the initiation of a detail design for the subdivision. To initiate the functional classification process, the developer should submit the following information:

Conceptual sketch. A conceptual sketch of the development that shows sufficient information for the Department to review and concur with the proposed functional classification for each street in the development shall be provided to the District Administrator's Designee by the local official prior to preparing detailed construction plans for review. Any preliminary or conceptual plat, plan or sketch that conforms to the locality's zoning requirements or subdivision ordinance is acceptable if the information required by this subsection is shown. For information to be included in the submittal, see [Secondary Street Acceptance Requirements, Chapter 382, 24 VAC30- 92-70, page 28.](#)

3. **Approval**

The District Administrator's Designee will provide written concurrence to the appropriate county official and the developer, if applicable, regarding the approved functional classification for each street in the subdivision. Approval of the conceptual plan or subdivision sketch should be considered concurrence of the functional classification and general layout of the streets. This approval shall be valid as long as the basic concept for the subdivision's development, as submitted for review, remains unchanged. Response is required per SSAR within 45 calendar days.

---

\* Rev. 7/09

## TERRAIN

The desired vertical curve alignment for subdivision street design can be accommodated within most terrains. However, in very rugged areas where the terrain can be classified mountainous, some design exceptions may be allowed. Mountainous terrain is defined as terrain in which longitudinal and transverse changes in the elevation of the ground with respect to a roadway are abrupt, and where the roadbed is obtained by frequent benching or side hill excavation to obtain acceptable horizontal and vertical alignment. The slope, which means the rise and fall of the grade measured both parallel and perpendicular to the centerline of the roadway, generally ranges over 15%.

Geographical location should not be the determining factor in terrain classification. For example, a subdivision street in the Bristol District may or may not have land characteristics of mountainous terrain. Each subdivision should be reviewed individually. Mountainous terrain exceptions are noted on the Geometric Design Tables 1-3. The mountainous terrain classification may be used upon approval by the District Administrator's Designee.\*

---

\* Rev. 3/09

## SECTION B(1) – 3 – ROADWAY GEOMETRIC DESIGN CRITERIA

### A. COLLECTOR AND ARTERIAL ROADWAYS

Streets functionally classified as a "collector" and "arterial" should be designed in accordance with applicable provisions in Appendix A of this Manual.\*

### B. LOCAL ROADWAYS

The following Geometric Design Standards shown in Tables 1 thru 3 are the minimum design criteria that shall apply to the design of all new residential and mixed-use streets functionally classified as "local" streets. Mixed-use is a single unified development with 0-2000 ADT that incorporates two or more different land uses within walking distance of one another; may include office, retail, public entertainment and a variety of housing types with some commercial usage. In mixed-use areas with 0-2000 ADT and truck traffic is less than or equal to 5%, the designer may utilize pavement widths for 0-2000 ADT shown in Table 1 and 2. If truck traffic is greater than 5%, the designer should utilize pavement widths for 2001-4000 ADT shown in Tables 1 and 2.

1. A single-unit (SU) truck design vehicle, as defined by AASHTO, should be used for the design of all local subdivision streets. Dimensions for this vehicle are depicted in Exhibit 2-4 of the AASHTO Geometric Design of Highways and Streets 2004, shown as Figure 1.

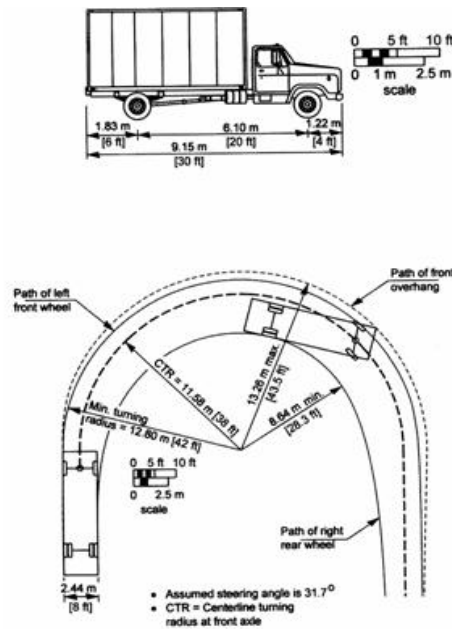

**FIGURE 1 – "EXHIBIT 2-4" SCANNED FROM "A POLICY ON GEOMETRIC DESIGN OF HIGHWAYS AND STREETS," AASHTO, 2004**

\* Rev. 7/09

2. The typical design criteria for each street should be uniform between intersections. The **District Administrator's Designee\*** may consider modifications as required to satisfy changes in traffic volume or as necessary to address environmentally sensitive areas.
3. Roadway designs should be broadly based on two categories, as depicted in Tables 1 and 2.
  - a. Shoulder and Ditch Design
  - b. Curb and Gutter Design, further defined by the land use served by the street – residential or nonresidential. (See Section B-4 (G) Curb and Gutter Design).
4. One-way street design criterion is depicted in Table 3.

### **C. TRANSITIONS AND TURN LANES**

1. Left or right turn lanes should be provided at intersections when the Department or locality determines that projected turning movements or safety warrants their installation. These facilities shall be designed in accordance with the appropriate provisions of [Appendix C](#) of the Department's Road Design Manual or other traffic impact tools specifically approved for use by the District Administrator. Where necessary, additional right-of-way width shall be provided to accommodate these facilities.
2. Normally where roadway section widths change, the centerline should not be offset. The length of the transition should be calculated using the following formula for design speeds less than 45 mph.

$$L = S^2W \div 60$$

L = length of transition

S = Design Speed

W = Width of offset on each side

Ex. Road narrows from 36' to 30'. Design speed is 25 mph.  
 $625 (3) \div 60 = 31.25$  ft

---

\* Rev. 3/09



**GEOMETRIC DESIGN STANDARDS FOR RESIDENTIAL AND MIXED USE SUBDIVISION STREETS (GS- SSR)**

**TABLE 1– CURB AND GUTTER SECTION\***

PROJECTED TRAFFIC VOLUME (ADT)	MINIMUM DESIGN SPEED (MPH)  (NOT POSTED SPEED)	HORIZONTAL AND VERTICAL CONTROLS					CURB AND GUTTER ROADWAYS		
		Maximum 2:1 Cut or Fill Slope Preferred 3:1 Cut or Fill Slopes					(Minimum Widths Measured Face of Curb to Face of Curb)		
		CURVE DATA		MAXIMUM % GRADE	MINIMUM SIGHT DISTANCE		NO PARKING (6)	PARKING 1 SIDE (2)	PARKING BOTH SIDES (2)
MINIMUM CENTERLINE RADIUS (5)	SUPER-ELEV.	STOPPING (3)	INTERSECTIONS (4)						
UP TO 2000	25	200'	NONE	NOTE (7)	155'	280'	24' (1)	24' (1)	29' (1)
2001 TO 4000	30	335'	NONE	NOTE (8)	200'	335'	26' (9)	31'(9)	36'(9)
<p>NOTES:</p> <p>For streets with volumes over 4000 or serving heavy commercial or industrial traffic; use the appropriate geometric design standard. (see VDOT's Road Design Manual)</p> <p>The roadway with the highest volume will govern the sight distance.</p> <p>Right of Way requirements can be found in Section B-4.1 Right Of Way</p> <p>For volumes 2001 – 4000 vpd, design criteria for the Collector functional class was utilized to determine minimum design values.</p> <p>Lower design speeds (and street widths) may be utilized provided they are designed in accordance with the AASHTO Green Book or AASHTO's Guidelines for Geometric Design of Very Low-Volume Local Roads (ADT&lt;400). The designer should coordinate with VDOT in advance of design (e.g. sketch plan stage) if this alternative criteria is being utilized.</p> <p>An engineering speed study sealed and signed by a licensed professional engineer, using VDOT's standard speed study report, must be provided by the developer and approved by VDOT for any roads posted at other than the statutory speed limit and planned for acceptance into the state system.</p>					<ol style="list-style-type: none"> <li>If the Local Street has 1 point of access and ADT&gt;400 vpd, then the roadway width must meet design values (2001 to 4000 vpd).</li> <li>With parking lanes, the horizontal clearance (measured from face of curb) is 1.5' (Min). 2004 AASHTO Green Book Chapter 5 (Page 399). However, VDOT has established a 3' minimum setback requirement behind the curb (This Manual, Section B-5, Figure 10).</li> <li>2004 AASHTO Green Book Chapter 3 (Page 112, Exhibit 3-1)</li> <li>2004 AASHTO Green Book Chapter 9 (Page 661, Exhibit 9-55). For grades greater than 3%, the time gap must be adjusted and required sight distance recalculated.</li> <li>2004 AASHTO Green Book Chapter 3 (Page 151, Exhibit 3-16)</li> <li>Horizontal clearance (measured from face of curb) is 1.5' (Min) 2004 AASHTO Green Book Chapter 5 (Page 399).</li> <li>2004 AASHTO Green Book Chapter 5 (Page 391).</li> <li>2004 AASHTO Green Book Chapter 6 (Page 432).</li> <li>Lane widths may vary between 10'-12' feet for collectors with 2001-4000 ADT. Widths shown may be decreased by 2 feet (26 feet to 24 feet), (31 feet to 29 feet) and (36 feet to 34 feet) based upon engineering judgment subject to VDOT approval.</li> </ol>				

\* Rev.7/09

**GEOMETRIC DESIGN STANDARDS FOR RESIDENTIAL AND MIXED USE SUBDIVISION STREETS (GS- SSR)**  
**TABLE 2 – SHOULDER AND DITCH SECTION\***

PROJECTED TRAFFIC VOLUME (ADT)	MINIMUM DESIGN SPEED (MPH)  (NOT POSTED SPEED)	HORIZONTAL AND VERTICAL CONTROLS					SHOULDER AND DITCH ROADWAYS			
		Maximum 2:1 Cut or Fill Slope					Minimum ditch width (front slope) should be 4 feet or greater, based on slopes of 3:1 or flatter (Gentler slopes promote homeowner maintenance of ditches)			
		CURVE DATA		MAXIMUM % GRADE	MINIMUM SIGHT DISTANCE		MINIMUM PAVEMENT WIDTH			MIN. TOTAL WIDTH OF SHOULDER (8) (9)
MINIMUM CENTERLINE RADIUS (4)	SUPER-ELEV.	STOPPING (2)	INTER-SECTION (3)		NO PARKING (5)	PARKING 1 SIDE (5)	PARKING BOTH SIDES (5)			
UP TO 2000	25	200'	NONE	NOTE (6)	155'	280'	24' (1)	24' (1)	29' (1)	6'
2001 TO 4000	30	335'	NONE	NOTE (7)	200'	335'	26' (10)	31' (10)	36' (10)	8'

<p><b>NOTES:</b></p> <p>For streets with volumes over 4000 or serving heavy commercial or Industrial traffic; use the appropriate geometric design standard. (see VDOT's Road Design Manual)</p> <p>The roadway with the highest volume will govern the sight distance.</p> <p>Right of Way requirements can be found in Section B-4.1 Right Of Way</p> <p>For volumes 2001 – 4000 vpd, design criteria for the Collector functional class was utilized to determine minimum design values.</p> <p>Lower design speeds (and street widths) may be utilized provided they are designed in accordance with the AASHTO Green Book or AASHTO's Guidelines for Geometric Design of Very Low-Volume Local Roads (ADT&lt;400). The designer should coordinate with VDOT in advance of design (e.g. sketch plan stage) if this alternative criteria is being utilized.</p> <p>An engineering speed study sealed and signed by a licensed professional engineer, using VDOT's standard speed study report, must be provided by the developer and approved by VDOT for any roads posted at other than the statutory speed limit and planned for acceptance into the state system.</p>	<ol style="list-style-type: none"> <li>If the Local Street has 1 point of access and ADT&gt;400 vpd, then the roadway width must meet design values (2001 TO 4000 vpd). For 0-400 ADT ONLY minimum pavement width may be reduced from 22 feet to 18 feet.</li> <li>2004 AASHTO Green Book Chapter 3 (Page 112, Exhibit 3-1)</li> <li>2004 AASHTO Green Book Chapter 9 (Page 661, Exhibit 9-55). For grades greater than 3%, the time gap must be adjusted and required sight distance recalculated.</li> <li>2004 AASHTO Green Book Chapter 3 (Page 151, Exhibit 3-16)</li> <li>Clear zone width for UP TO 2000 vpd is 7' and clear zone values for 2001 TO 4000 vpd is 10'.</li> <li>2004 AASHTO Green Book Chapter 5 (Page 391)</li> <li>2004 AASHTO Green Book Chapter 6 (Page 432)</li> <li>2004 AASHTO Green Book Chapter 5 (Page 384, Exhibit 5-5)</li> <li>Add an additional 3' if guardrail is required.</li> <li>Lane widths may vary between 10'-12' feet for collectors with 2001-4000 ADT. Widths shown may be decreased by 2 feet (26 feet to 24 feet), (31 feet to 29 feet) and (36 feet to 34 feet) based upon engineering judgment subject to VDOT approval.</li> </ol>
---	---

\* Rev. 7/09

**GEOMETRIC DESIGN STANDARDS FOR RESIDENTIAL AND MIXED USE SUBDIVISION STREETS (GS- SSR)**  
**TABLE 3 – ONE-LANE (ONE-WAY) SUBDIVISION STREETS**

TRAFFIC	PROJECTED TRAFFIC VOLUME (ADT)	DESIGN SPEED (MPH) (NOT POSTED SPEED)	HORIZONTAL AND VERTICAL CONTROLS Maximum 2:1 cut or fill slope				ROADWAY SECTION CRITERIA						
			MINIMUM CURVE RADIUS (WITHOUT SUPERELEV.)	MAXIMUM % GRADE	MINIMUM SIGHT DISTANCE		SHOULDER AND DITCH ROADWAYS Minimum ditch width (front slope) should be 4 feet or greater, based on slopes of 3:1 (Gentler slopes promote homeowner maintenance of ditches) *Width includes 3' for G.R. installation. <b>(NO PARKING)</b>				CURB AND GUTTER ROADWAYS <b>(NO PARKING)</b> CURB TO CURB WIDTH		
					STOPPING	INTERSECTION	MINIMUM ROADWAY WIDTH	FILL WITH G.R.	CUT OR FILL W/O G.R.	CLEAR ZONE (FROM EDGE OF TRAVELWAY)	CURB TO CURB WIDTH	CLEAR ZONE (FROM FACE OF CURB)	
ONE-WAY (1- LANE)	≤ 400	25	198' (4)	NOTE (2)	125' (5)	115' (6)	15' (7)	5'	2' (1)	6' (3)	15' (7)	1.5'	
<p>NOTES:</p> <p>These design standards may also be used for one-way divided pairs, such as subdivision entrances with wide medians.</p> <p>On-street parking is anticipated; a parking lane width not less than 7 feet should be used.</p> <p>Right Of Way requirements can be found in Section B-4.1 Right of Way.</p> <p>Lower design speeds (and street widths) may be utilized provided they are designed in accordance with the AASHTO Green Book or AASHTO's Guidelines for Geometric Design of Very Low-Volume Local Roads (ADT&lt;400). The designer should coordinate with VDOT in advance of design (e.g. sketch plan stage) if this alternative criteria is being utilized.</p> <p>An engineering speed study sealed and signed by a licensed professional engineer, using VDOT's standard speed study report, must be provided by the developer and approved by VDOT for any roads posted at other than the statutory speed limit and planned for acceptance into the state system.</p>							<ol style="list-style-type: none"> <li>2004 AASHTO Green Book Chapter 5 (Page 384 – Exhibit 5-5)</li> <li>2004 AASHTO Green Book Chapter 5 (Page 391)</li> <li>Clear zone widths may be reduced with the concurrence of the District Administrator's Designee where terrain or social/environmental impact considerations are appropriate. (AASHTO 2001 Very Low Volume Local Roads Guide Chapter 4, Page 48)</li> <li>AASHTO 2004 Green Book Chapter 3 (Page 151, Exhibit 3-16)</li> <li>AASHTO 2001 Very Low Volume Local Roads Chapter 4 (Page 34, Exhibit 8)</li> <li>AASHTO 2001 Very Low Volume Local Roads Chapter 4 (Page 45, Exhibit 14, August 2002 Errata)</li> <li>If on-street parking is allowed the appropriate additional paved width needs to be provided.*</li> </ol>						

\* Rev. 7/09

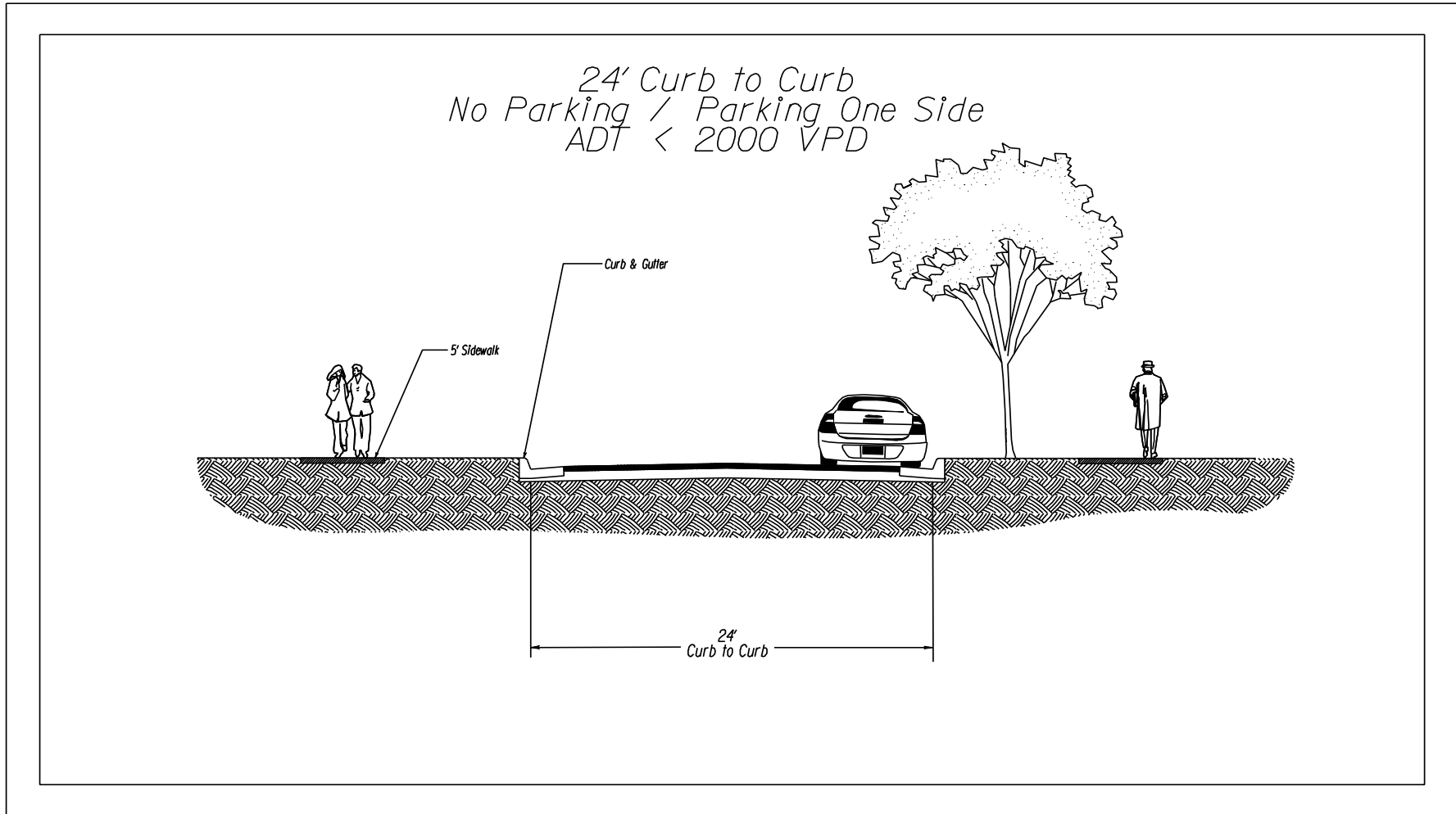

**FIGURE 1.1 – 24' CURB TO CURB NO PARKING / PARKING ON ONE SIDE\***

\* Added 3/09

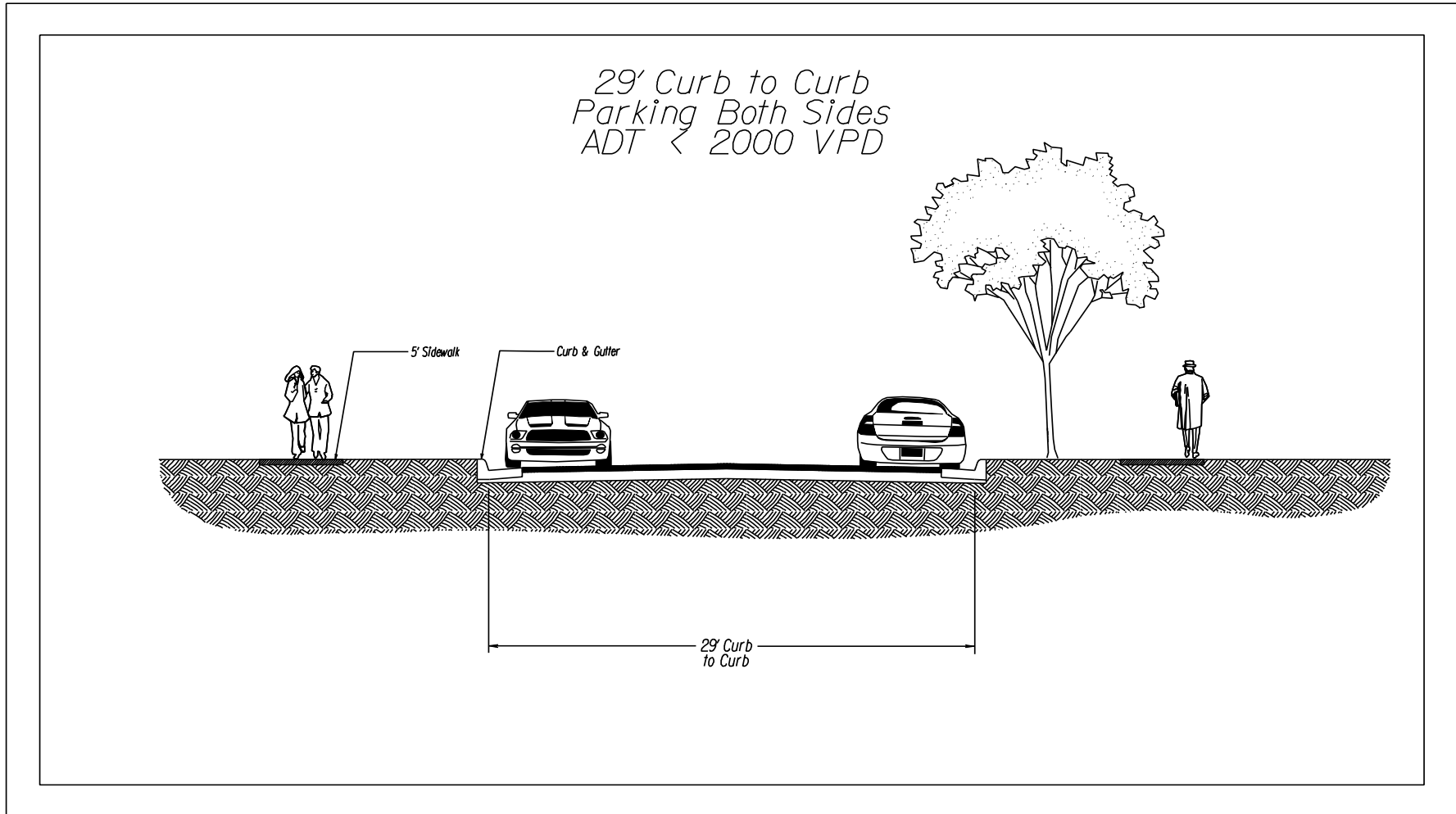

**FIGURE 1.2 – 29' CURB TO CURB PARKING ON BOTH SIDES\***

\* Added 3/09

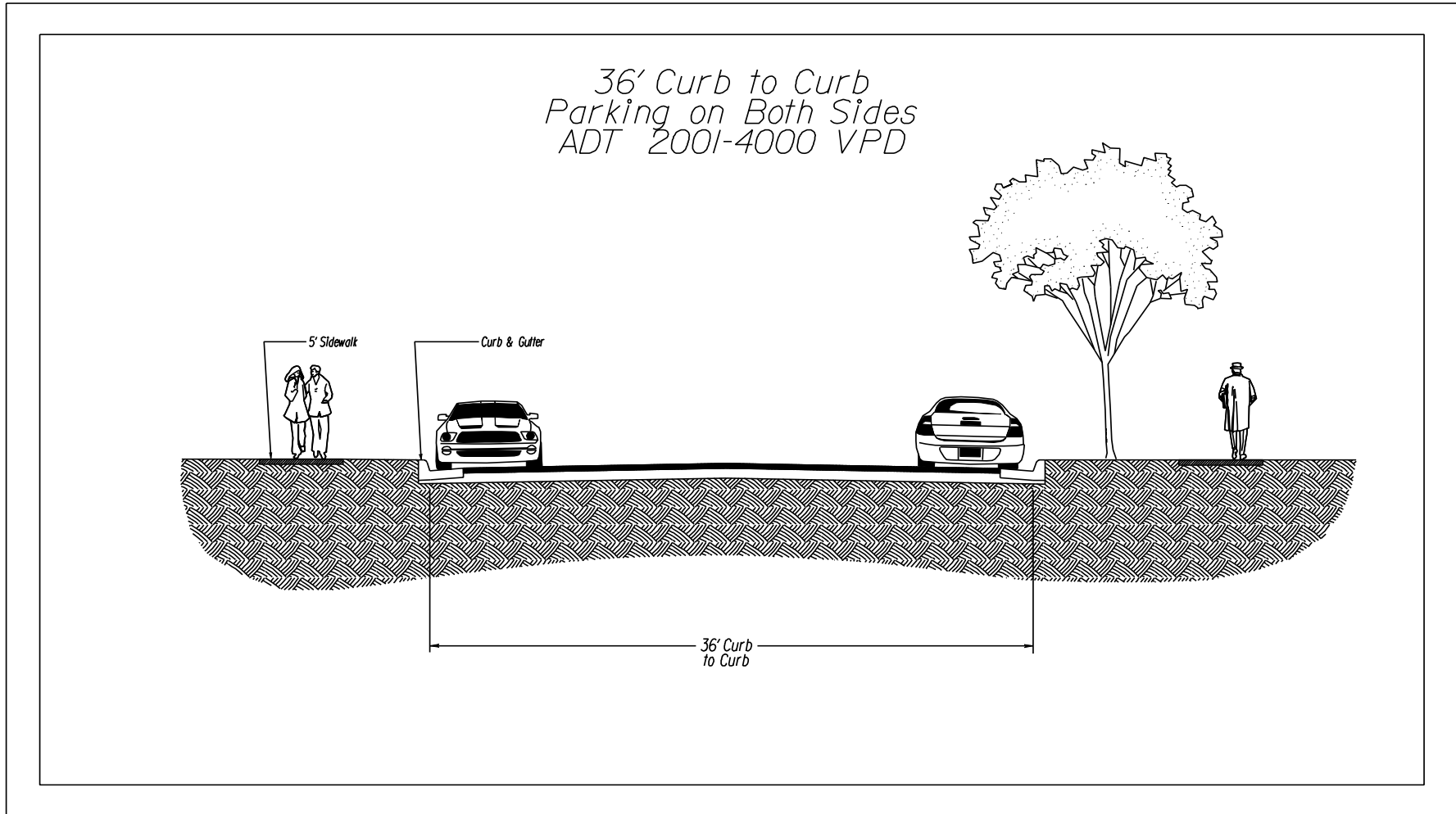

**FIGURE 1.3 – 36' CURB TO CURB PARKING ON BOTH SIDES\***

---

\* Added 3/09

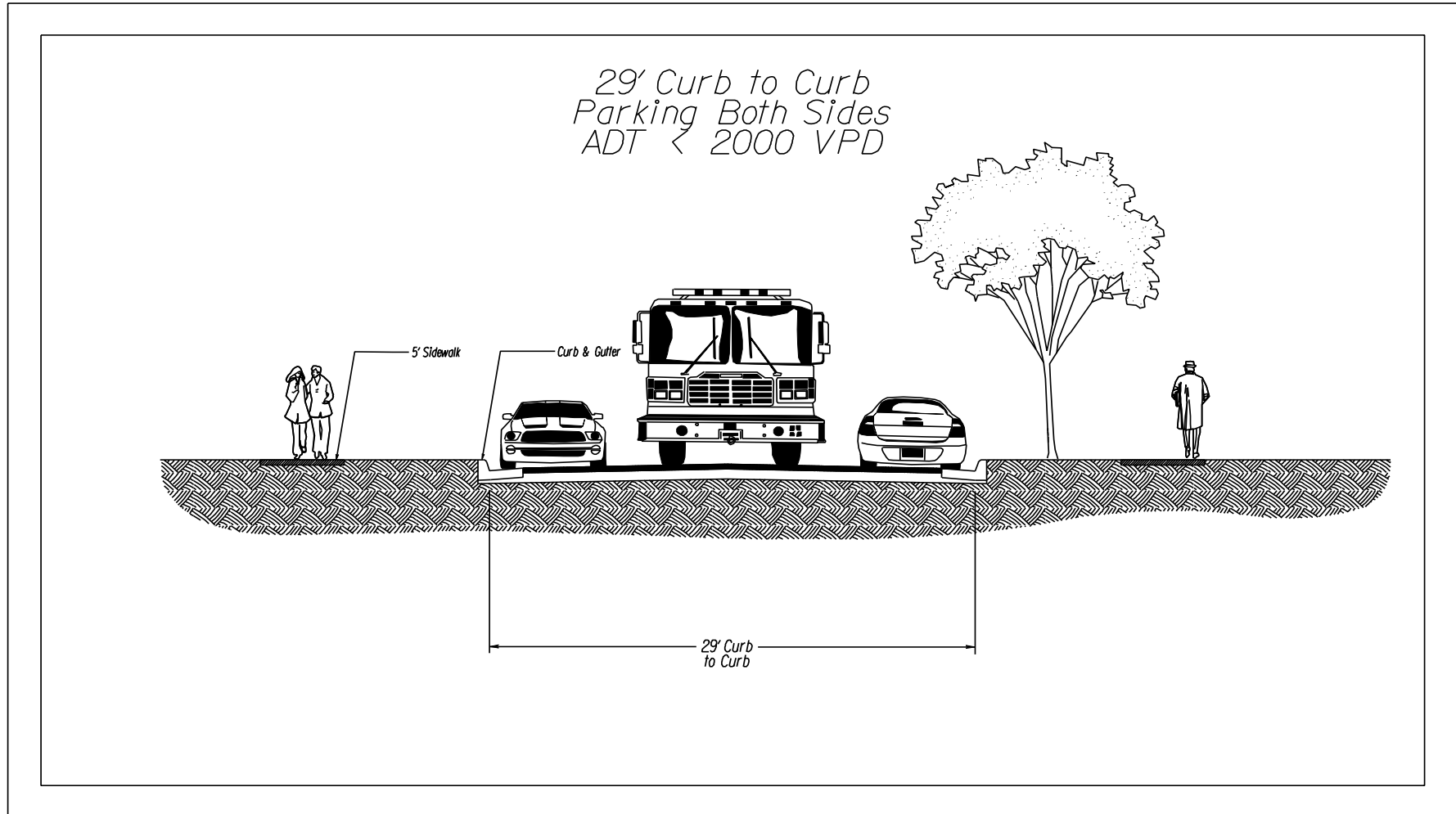

**FIGURE 1.4 – 29' CURB TO CURB PARKING ON BOTH SIDES\***

\* Added 3/09

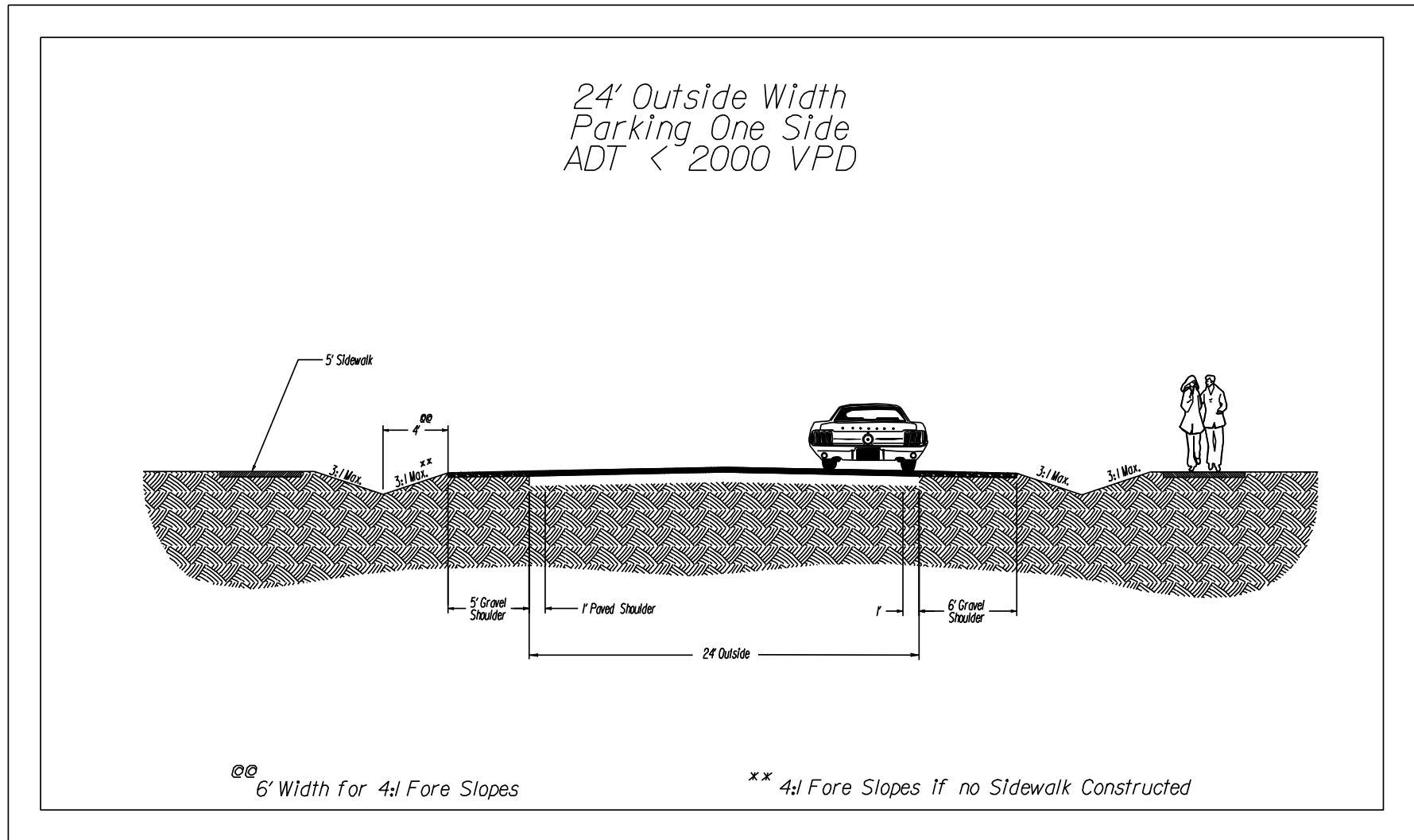

**FIGURE 1.5 – 24' OUTSIDE WIDTH PARKING ONE SIDE\***

\* Added 3/09



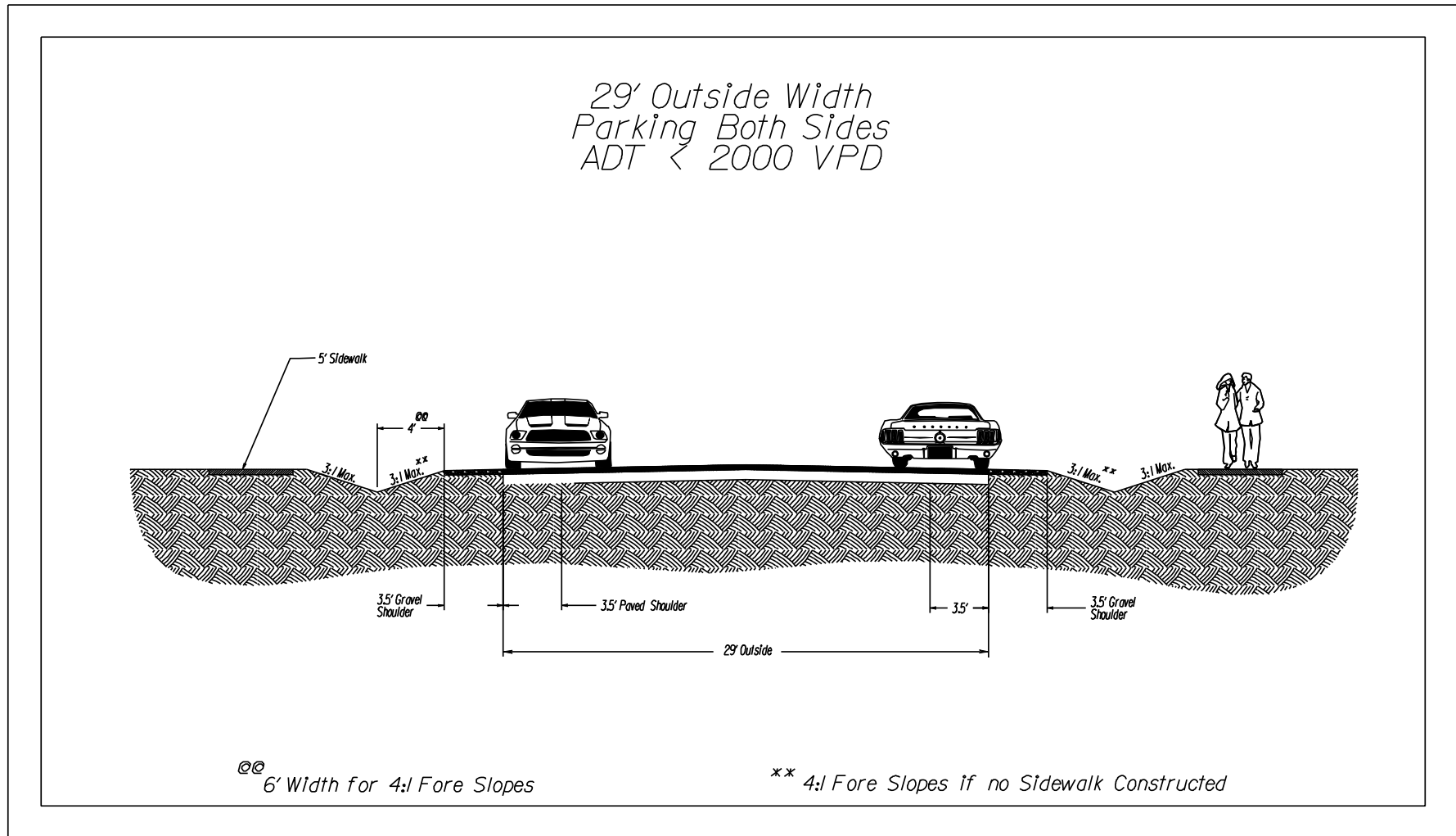

**FIGURE 1.6 – 29' OUTSIDE WIDTH PARKING ON BOTH SIDES\***

\* Added 3/09

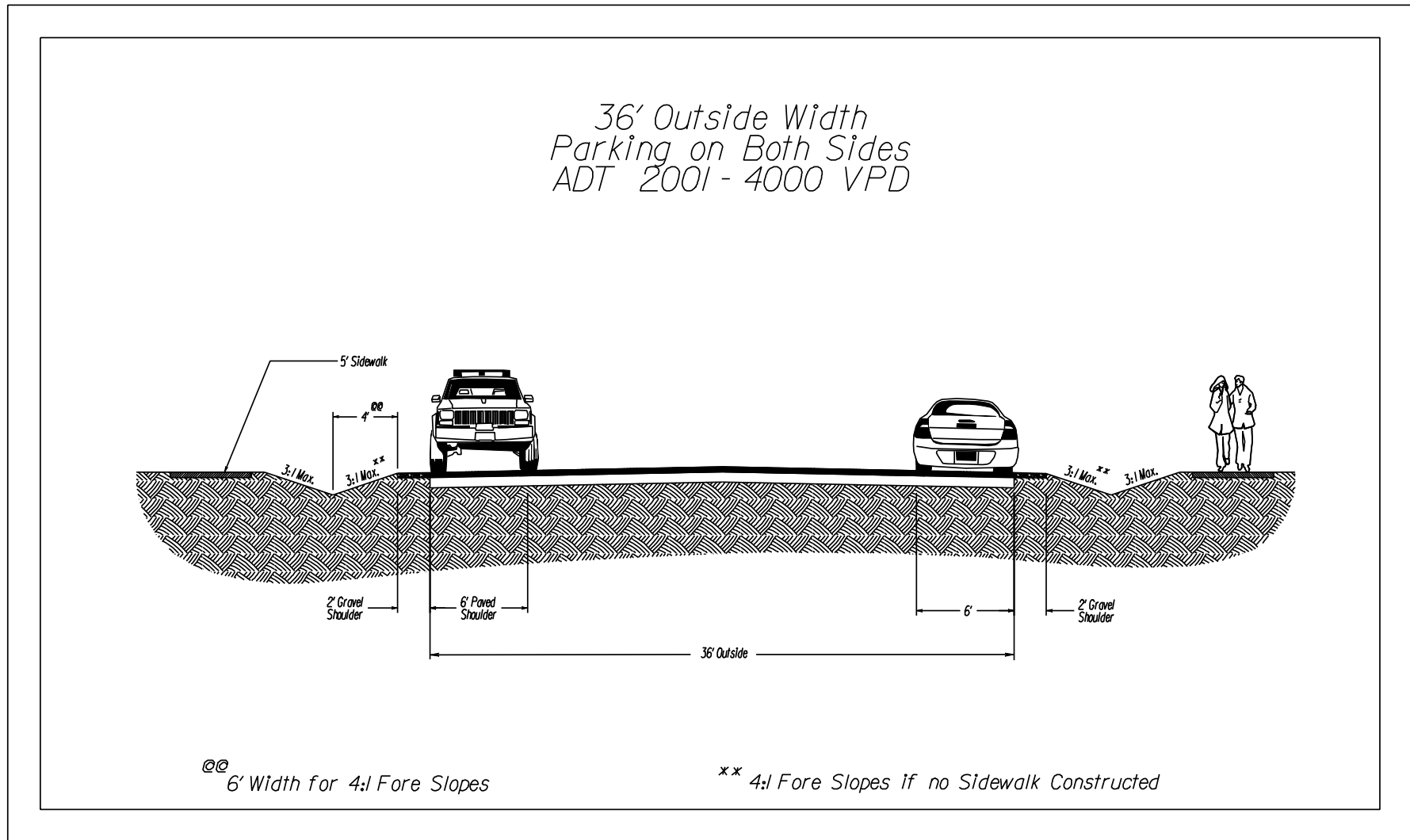

**FIGURE 1.7 – 36' OUTSIDE WIDTH PARKING ON BOTH SIDES\***

\* Added 3/09

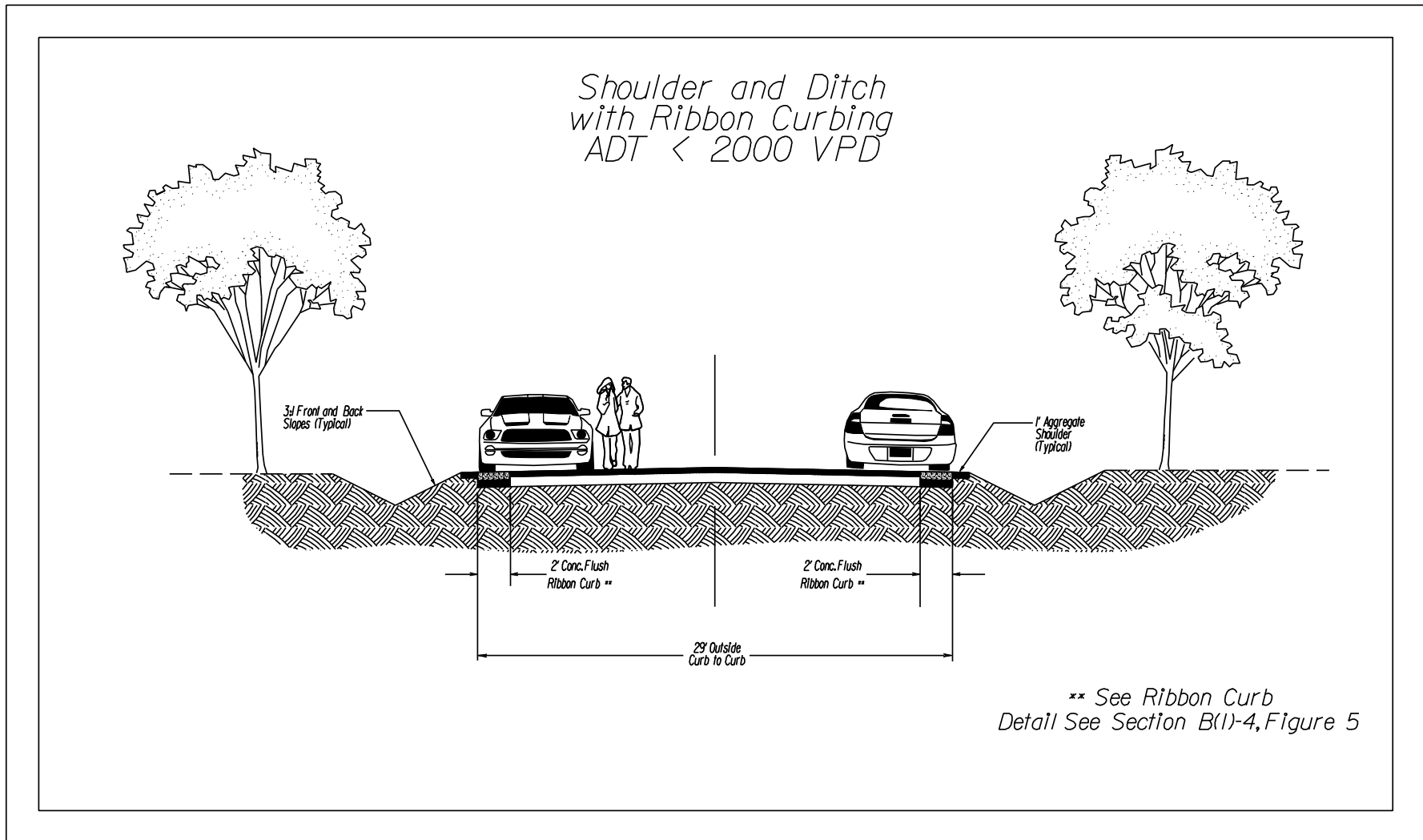

**FIGURE 1.8 – 29' STABILIZED SHOULDER AND DITCH WITH RIBBON CURB\***

\* Added 7/09

## GEOMETRIC DESIGN STANDARDS FOR SCHOOL BUS ACCESS ROAD

The minimum pavement widths for school bus access roads, by section type.

One Way	Rural (Shoulder)	Urban (Curb & Gutter)
Pavement	16 feet	22 feet (2)
Shoulders	4 feet (1)	-----
Parking	Prohibited	8 feet additional per parking lane
Minimum Turning Radius	45 feet	45 feet
Two Way	Rural (Shoulder)	Urban (Curb & Gutter)
Pavement	24 feet	24 feet (2)
Shoulders	4 feet (1)	-----
Parking	Prohibited	8 feet additional per parking lane
Minimum Turning Radius	45 feet	45 feet

Notes: (1) Without Guardrail; with Guardrail add 3 feet.  
 (2) Minimum 30 feet R/W as required.

**TABLE 4 – SCHOOL BUS ACCESS ROAD\***

---

\* Rev. 3/09

**D. SIGHT DISTANCE**

1. **Stopping sight distance** – Stopping sight distance shall be based on a height of eye of 3.5 feet and an object height of 2.0 feet along the center of the travel lane.
2. **Intersection sight distance** – Intersection sight distance should be measured presuming a stop condition of the minor roadway. Sight distance shall be based on a height of eye of 3.5 feet and an object height of 3.5 feet. Dedicated right of way may be required to preserve appropriate sight distance at intersections. The District Administrator's Designee may consider an easement as an alternative to dedicated right of way.
3. **Sight Distance Triangles**

The intersection sight distance is measured along the major roadway, based on the major roadway's design or, in the case of existing roadways, the operation speed limit.

Decision points (A, B and C in Figure 2) represent the position of drivers along the major and minor roadways. Two sight distance triangles are considered, one in each direction of the major roadway from decision point A, which represents the driver exiting the minor roadway.

Decision point A is located 4 feet from the centerline or left edge of pavement of the minor roadway and 20 feet from the middle of the nearest travel lane of the major roadway. (For reference purposes, AASHTO defines this point as 14.4 to 17.8 feet from the edge of the travel lane of the major roadway.)

Decision point B is located in the middle of the nearest travel lane of the major roadway.

Decision point C is located in the nearest right to left movement lane of the major roadway, 4 feet from the centerline or the left edge of pavement.

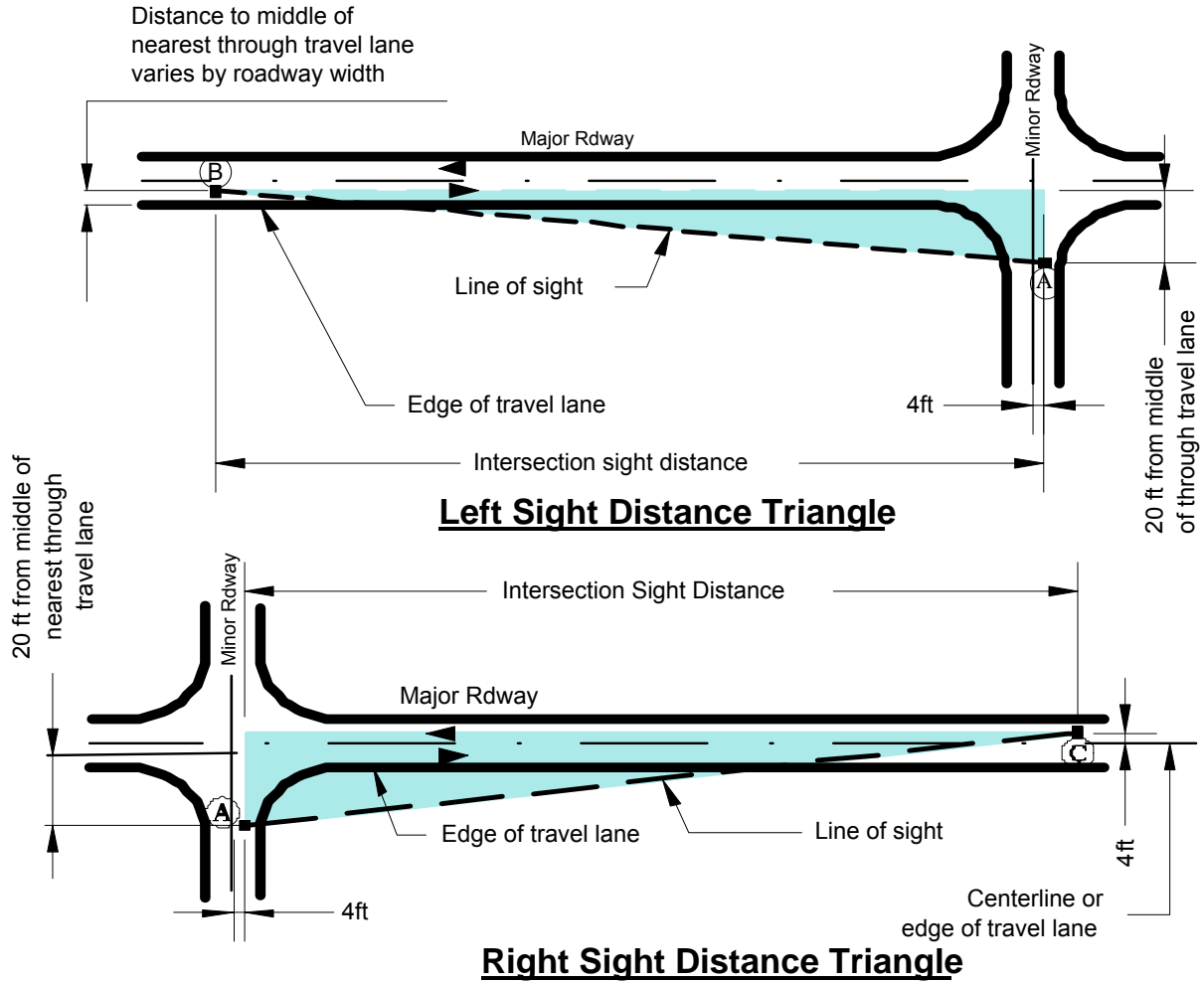

**FIGURE 2 – SIGHT DISTANCE TRIANGLES**

3. Additional information regarding sight distance requirements is available in *AASHTO's A Policy on Geometric Design of Highways and Streets*.

## **SECTION B(1) – 4 – ELEMENTS OF TYPICAL SECTION**

### **A. PAVEMENT DESIGN**

1. Pavement design for new subdivision streets shall be developed using the Pavement Design Guide for Subdivision and Secondary Roads in Virginia.
2. “Standard crown” means the cross slope of the roadway pavement and should be 1/4 inch per foot (2%), unless otherwise increased by the District Administrator’s Designee. Blot and seal pavements should have a crown of 3/8 inch per foot.

### **B. PAVEMENT WIDTH**

1. Except as may be permitted in this subsection, the minimum pavement widths shall be as shown in Tables 1 through 3. Also see Typical Sections Figures 1.1 through 1.7.
2. Unless otherwise indicated, the use of curb and gutter anticipates on street parking. Parking along streets with shoulder and ditch design is not desirable. However, if the locality desires to allow parking on a shoulder and ditch design, a minimum 15 ft of clear roadway width for emergency vehicles must be maintained at all times.\*
3. Designated parking widths may be utilized in lieu of shoulders; however, the minimum width of travel way must be maintained.

### **C. PARKING LANE WIDTHS (CURB AND GUTTER ONLY)**

The use of curb and gutter and/or shoulder and ditch designs for on-street parking will be accommodated, using the following widths for the parking lane:

Residential and mixed-use local streets – 7 feet in width measured from the face of curb

Commercial and industrial – 8 feet in width measured from the face of curb

### **D. INTERSECTIONS**

1. Angle of intersection

Streets should intersect at right angles; however, intersecting angles between 60 and 90 degrees are allowed.

A landing, having a minimum of 50’ in length and a maximum vertical grade of 2%, should be provided at each intersection. Sign islands may be permitted if approved by the District Administrator’s Designee.

---

\* Rev. 7/09

2. Spacing (i.e. Minimum distance between intersecting roadways)

Offset intersections are discouraged. Intersections or intersecting streets on the same side or opposite sides shall be spaced a minimum of 200 feet and this distance shall be adjusted upward based on upstream and downstream intersection turning movement volumes. Figure 3 illustrates the desirable spacing.

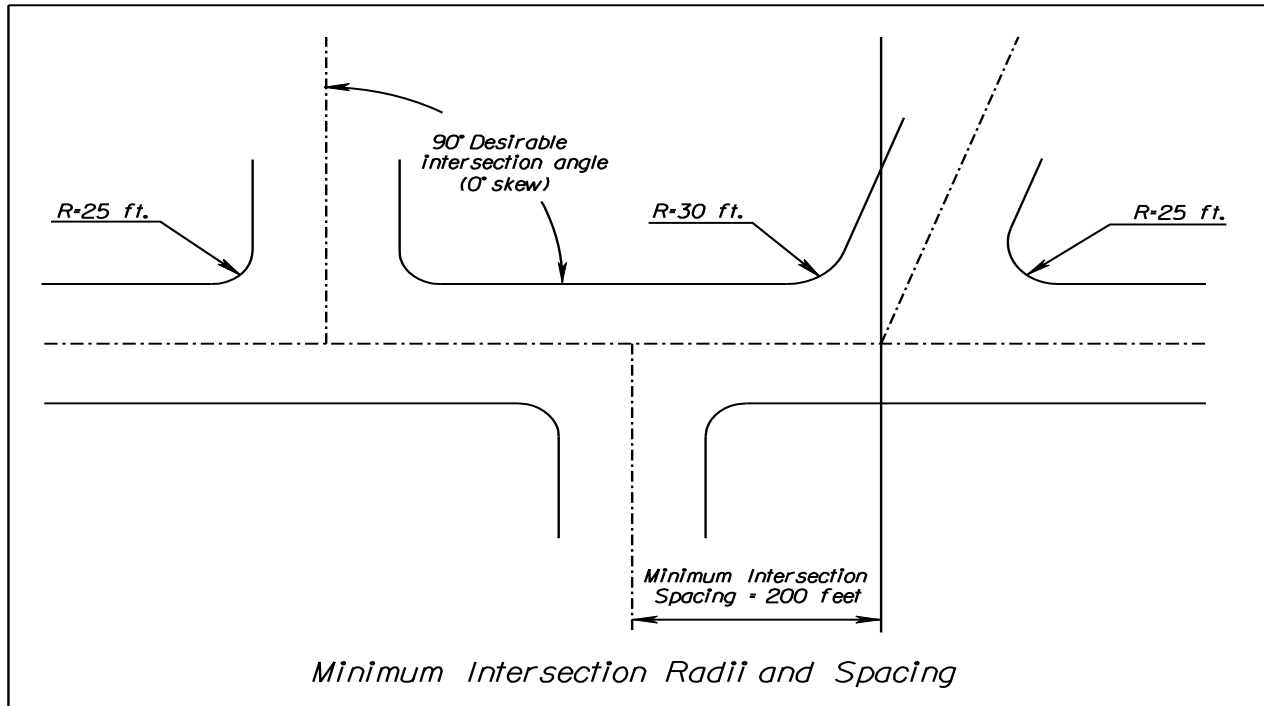

**FIGURE 3 – INTERSECTION DESIGN**

3. Minimum Radii

Intersection radii should be the same on all quadrants of an intersection. However, roadway alignments, traffic volumes along the respective legs, and other factors may warrant consideration of using different radii and may be considered. For skew intersections, radii shall be not less than 25 feet for the acute angle and 30 feet for the obtuse angle of the intersection street.

At street intersections, there are two distinct radii that need to be considered, the effective turning radius of the turning vehicle and the radius of the curb return (See 2004 AASHTO Green Book, Exhibit 5-10). The effective turning radius is the minimum radius appropriate for turning from the right-hand travel lane on the approach street to the appropriate lane of the receiving street. This radius is determined by the selection of a design vehicle appropriate for the streets being designed and the lane on the receiving street into which that design vehicle will turn.\*

\* Rev. 7/09



The minimum effective turning radius at street intersections on subdivision streets shall not be less than 25 feet. If intercity buses, single unit trucks or standard 65-passenger school buses are expected to use the street, the minimum radius should be increased to accommodate the turning radius of such vehicles. Minimal encroachment into the opposing lane of traffic of the receiving street is expected. The minimum radius of the curb return shall not be less than 5 feet.\*

A larger radius or additional pavement at the intersection may be required on shoulder and ditch sections to avoid shoulder rutting.

Auto-TURN® diagrams should be used to demonstrate the impact on the opposing lane of the receiving street and the sufficiency of the street widths to accommodate the vehicles without running off of pavement or scrubbing curbs.

#### **E. CONCENTRIC DESIGN**

Normally, the design of principal roadway elements of subdivision streets should be concentric about the center of the right-of-way. However, certain circumstances and special development goals, such as phased development may justify arrangements that require one side of the right of way to differ from the other, when based on a typical centerline between travel lanes. The normal typical section may be varied as necessary to provide for vehicular or pedestrian safety or both and traffic channelization features, e.g., turn lanes, intersection radius, etc.

#### **F. CUL-DE-SACS AND TURNAROUNDS**

To afford the greatest flexibility in design, various types of turnaround designs may be used on subdivision streets. Additional right-of-way shall be provided as required by the turnaround design to continue the right of way limits around the perimeter of the turnaround. Acceptable Cul-de-sac designs include:

---

\* Rev. 7/09

a. Circular Type Turnarounds

For circular turnarounds, a well-defined identifiable street segment, equal to the normal lot width along the intersected street that serves the cul-de-sac or 50 feet whichever is greater, shall extend from the intersected street to the turning area. A minimum radius of 45 feet, measured to the edge of pavement or face of curb, shall be used for circular turnarounds on residential cul-de-sac streets serving more than 25 dwellings and greater than 0.25 mile in length. A 45 foot radius should also be used if standard 65 passenger school buses are expected to use the cul de sac, or for any nonresidential use. For circular turnarounds on short low volume residential cul-de-sac streets, this minimum radius may be reduced to 30 feet when specifically approved by the locality in consultation with emergency services.

b. Cul de sacs with unpaved centers (Islands)

When a circular turnaround is proposed with an unpaved area in the center, the roadway around the center should be considered a one-way street and designed according to Table 3 for Roadway Section Criteria. Pavement widths may be increased by the District Administrator's Designee\* to accommodate turning radii of single unit truck design vehicle. Parking should be restricted to the outside of the curve. Cul de sacs with curb and gutter should have a raised curb along the circumference of the island, unless the cul de sac is being developed to accommodate low impact development techniques.

The unpaved area should have a minimum radius 30 feet and maximum radius of 120 feet. Unpaved center areas should have a ten-foot clear zone around the circumference of the circle. Any non-travel areas included within turnarounds should be included in the dedicated right-of-way of the facility.

If the center radius is greater than 120 feet, the street will be considered a loop street and should be designed in accordance with tables 1 and 2 for two-way traffic.

c. Alternative Turnarounds (for Residential streets only)

"T and Branch" type turnarounds may be considered for short streets less than 0.25 miles in length. Other proposals must be judged on their merits. However, when proposed, the ability of single unit truck design vehicles to reverse direction on these alternative types of turnarounds, without leaving the pavement area should be proven.

---

\* Rev. 3/09

d. Temporary turnarounds and stub streets

A turnaround should be provided for any temporary or stub street longer than 150' from the point of intersection to the end of pavement.

Any portion of the turnaround outside the dedicated right of way for the stub street may be placed in an easement.

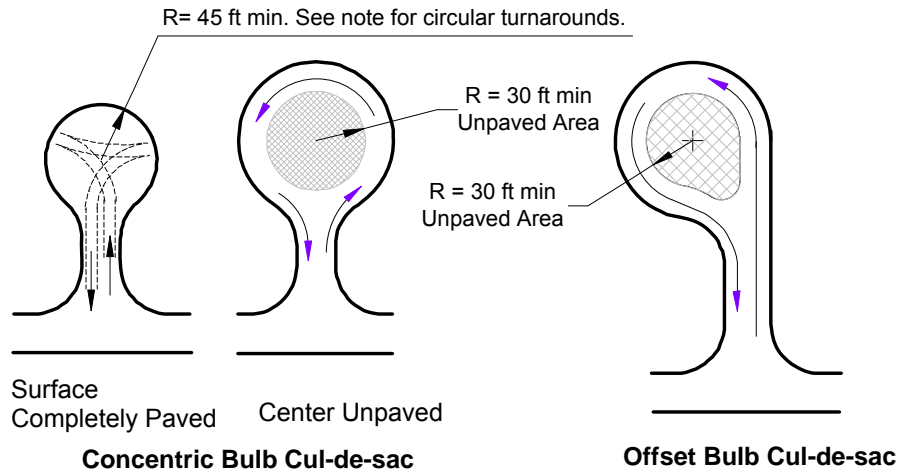

For circular turnarounds on short low volume residential cul-de-sac streets, the 45 ft minimum radius may be reduced to 30 feet when specifically approved by the locality in consultation with emergency services.

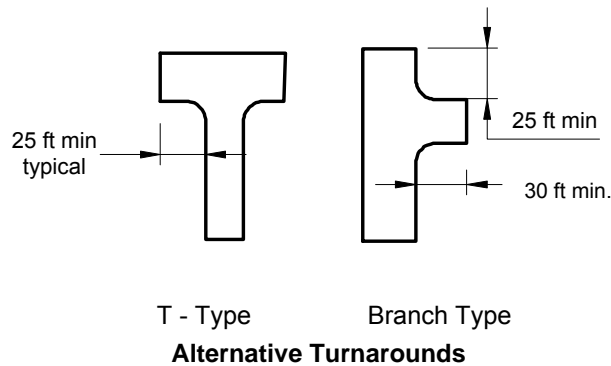
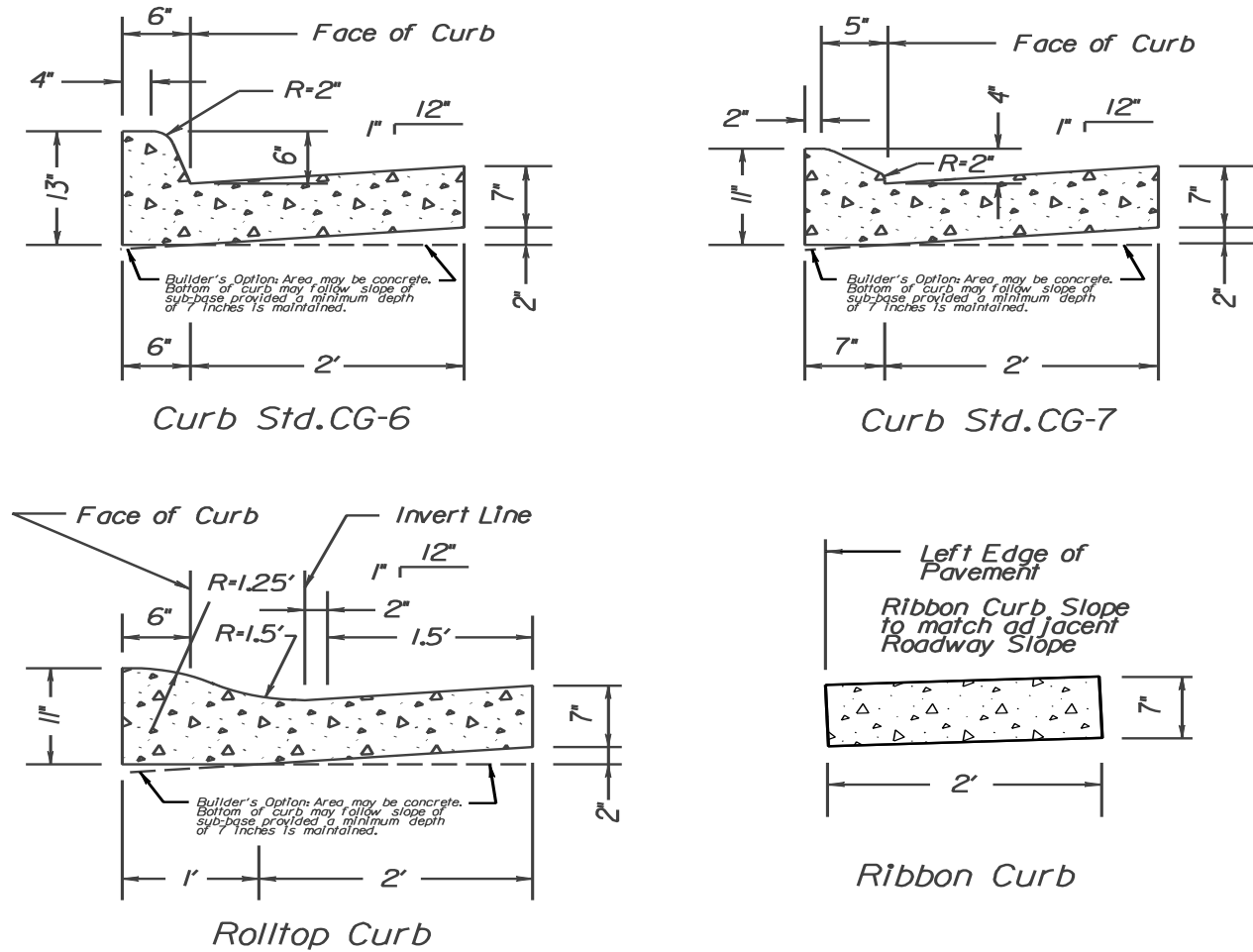

**FIGURE 4 – CUL-DE-SAC DETAILS\***

\* Rev. 3/09

**G. CURB AND GUTTER DESIGNS**

The Department does not require the use of curb and gutter on subdivision streets but recognizes that it is an acceptable design alternative and preferred in high density developments. Curb and gutter designs shown in Figure 5 are appropriate for Subdivision streets.



**FIGURE 5 – CURB AND GUTTER DETAILS\***

The following notes apply to CG-6, CG-7 and Rolltop curb:

1. Curb and gutter may be precast of Class A4 hydraulic cement concrete or cast in place using Class A3 hydraulic cement concrete.
2. When used with stabilized, open-graded drainage layers, the bottom of the curb and gutter shall be constructed parallel to the slope of the sub-base courses and to the depth of the pavement but not less than the thickness shown.

\* Rev. 7/09

3. Use of curb and gutter has a direct relation to the design speed of the roadway of which it is a part, as follows:
  - a. CG-6 may be used in urban and suburban settings (including subdivisions) on streets having a design speed not greater than 45 mph.
  - b. CG-7 may be used in lieu of CG-6, but must be used along all roadways having a design speed in excess of 45 mph in urban and suburban settings (including subdivisions).
  - c. Rolltop curb and gutter and **Ribbon curb\*** may be used along subdivision streets having a design speed not greater than 30 mph.

4. All curb and gutter designs shall transition to match entrance gutters or another curb and gutter type or standard curb openings within 10 feet of the change in gutter type.

5. Curb ramps

All streets that incorporate accessible routes for pedestrian use shall include curb ramps at intersections for use by persons with disabilities, without regard to the curb design used. Curb ramps should be constructed in accordance with Standard CG-12. Further guidance on the design of curb ramps may be found in Location and Design [IIM-LD-55](#).

6. Treatment behind curbs

Where curb and gutter is used, a 1/4 inch per foot (2%) graded area, a minimum 3 feet in width, should be provided behind the back of curb.

Where sidewalk is used in conjunction with curb and gutter, a buffer strip is recommended behind the curb as shown in Figure 6. This buffer strip may be paved with a suitable material approved by the District Administrator's Designee, but the paved portion of the buffer strip should not be considered to be part of the prescribed width for sidewalks. Sidewalk placed adjacent to curb shall be 8 feet in width to allow vehicle doors to open and people to exit from the vehicle without blocking the pedestrian access route.

---

\* Rev. 7/09

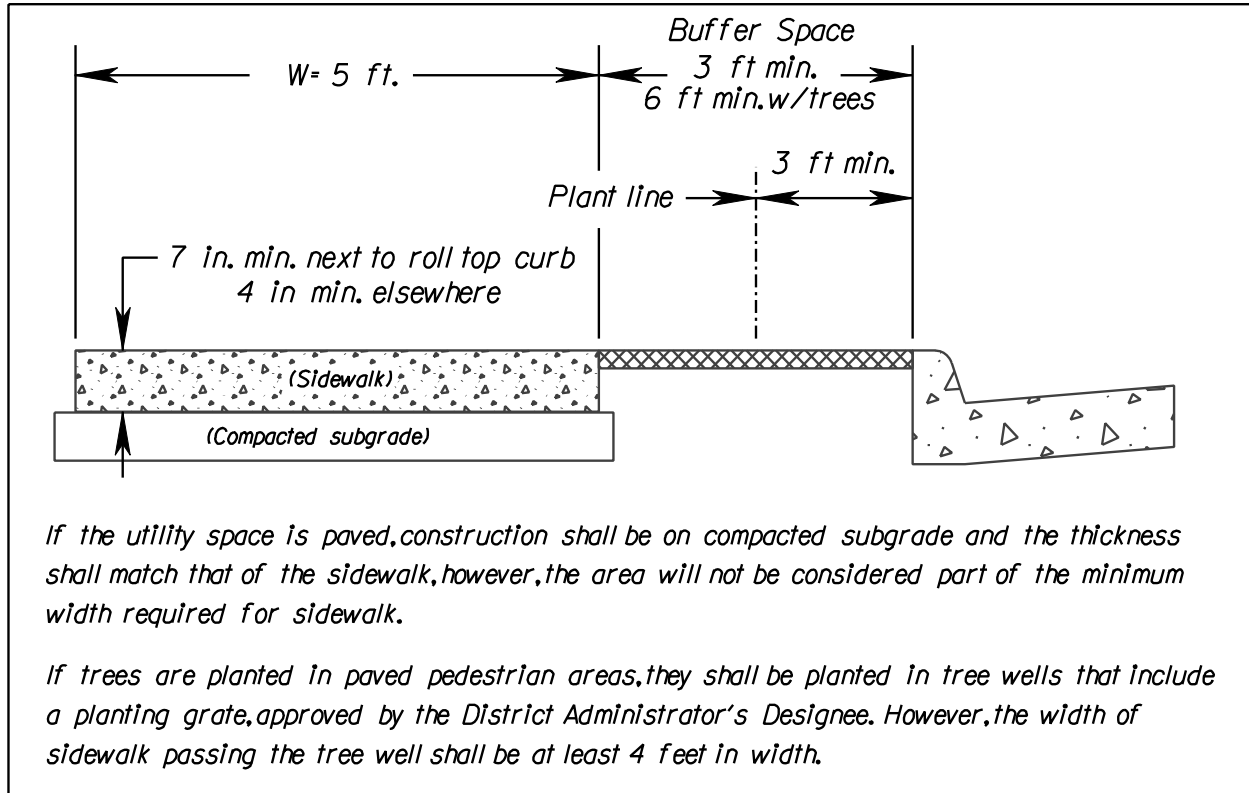

**FIGURE 6 – DETAIL BACK OF CURBS\***

## H. PRIVATE ENTRANCES

### 1. Curb and gutter private entrances

At all driveway entrances, standard entrance gutter (Std. CG-9B or CG-9D) shall be used with Standard CG-6 or CG-7 curb and gutter. A special design entrance gutter shall be submitted to the District Administrator's Designee for approval when roll top curb is used, similar to that shown in Figures 7 and 8.

\* Rev. 3/09

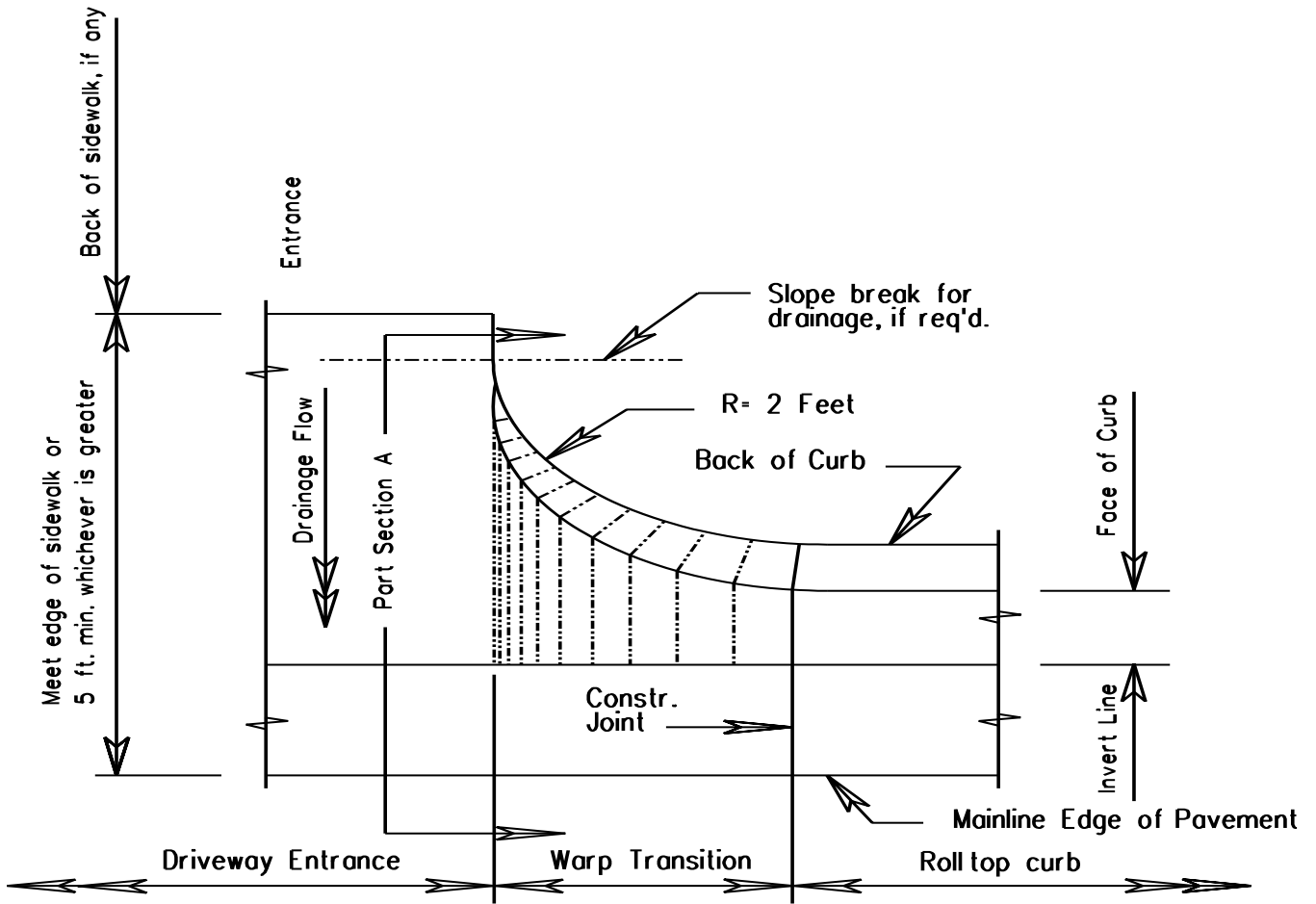

Part Plan of Entrance Transition  
**FIGURE 7 – ROLL TOP CURB ENTRANCE DETAIL**

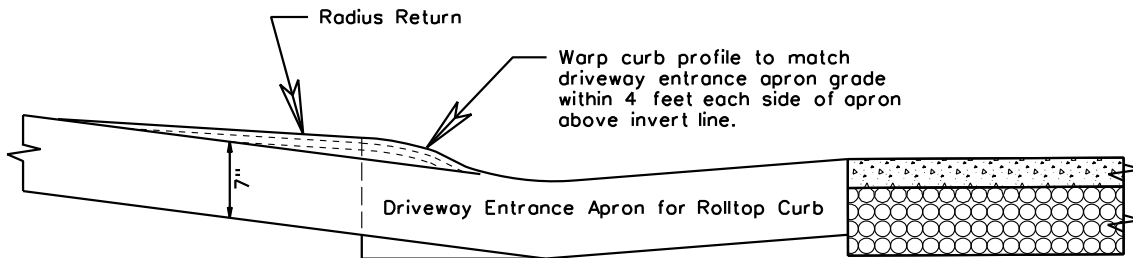

Part Section A

**FIGURE 8 – ROLLTOP CURB ENTRANCE DETAIL SECTION**

2. Ditch section private entrances

All private entrances shall be designed to serve one or two individual lots on a local subdivision street. All private entrances should be designed and constructed as shown in Figure 9. Entrance radius should be 20' except in high density areas where a 12' radius can be allowed. All entrance pipe culverts will be sized to accommodate the run off expected from a 10-year frequency storm.

If drainage is necessary, the ditch line may be moved back to provide cover for pipe. Entrances shall be at least 12 ft. wide and shall be tied into the roadway smoothly. The driveway entrance surface shall extend from the edge of the roadway to the right of way line. Entrance surface can be crusher run aggregate or paved.

3. Driveway entrance grades

In the interest of assuring an adequate, convenient, and safe access to public roads, VDOT recommends the grades along driveways not exceed 10%.

Notes:

See VDOT Road and Bridge Standards, Std. PE-1 for cut/fill details.

All entrance grades shall start back of the shoulder line.

If drainage is necessary, the ditch line may be moved back to provide 9 inches (min.) cover over pipe.

Entrances shall be 12 ft wide and transition smoothly into the roadway surface. Driveway entrance pavement shall extend to the right of line. When an existing street is re-developed and modification of an existing driveway entrance is required, the entrance pavement shall be extended to the right of way line or the extent of disturbance to the existing driveway.

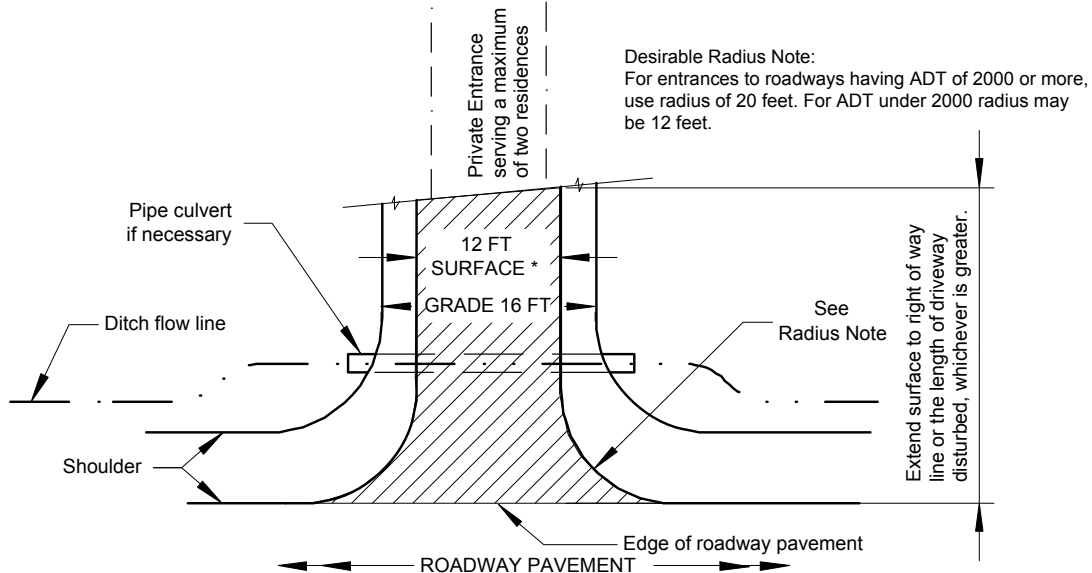

**FIGURE 9 – PRIVATE ENTRANCE DETAIL**



## I. PEDESTRIAN AND BICYCLE FACILITIES

See VDOT's "Policy for Integrating Bicycle and Pedestrian Accommodations". This policy is available on the web:

[http://www.virginiadot.org/programs/resources/bike\\_ped\\_policy.pdf](http://www.virginiadot.org/programs/resources/bike_ped_policy.pdf)

### 1. Sidewalk Standards

#### A. General

- (1) Sidewalks proposed for VDOT maintenance shall be completely contained within the right of way. Sidewalks should generally conform to the vertical alignment of the adjacent roadway.
- (2) Sidewalks should be a minimum of 5 feet in width. Sidewalks shall be designed in accordance with ADA requirements and VDOT's Location and Design Instructional Memoranda [IIM-LD-55](#), Curb Ramps and Sidewalks, located at <http://www.virginiadot.org/business/locdes/rd-ii-memoranda-index.asp>.
- (3) Sidewalks shall not be less than 4 inches thick, except when used in conjunction with roll top curb, in which case the thickness shall be 7 inches. See Section B(1)-4.G Curb and Gutter Designs, Figure 6-Detail Back of Curbs.
- (4) Sidewalks shall be a minimum of\* 3 feet behind the back of curb on curb and gutter sections to allow for the placement of signs in accordance with the MUTCD, Part 2 and, if trees are to be planted between the curb and the sidewalk, the sidewalk shall be not less than 6 feet behind the back of curb with the trees planted so that the center of the tree trunk is not less than 3 feet behind the curb. Sidewalk placed adjacent to the curb shall be 8 feet in width to accommodate the opening of car doors. See Figure 6 and 10.
- (5) Sidewalks located on a fill section requiring guardrail shall be located in front of the guardrail.

#### B. Sidewalks along curb and gutter streets

- (1) Sidewalks along curb and gutter streets shall be constructed with hydraulic cement concrete sidewalk or solid paving units.
- (2) Concrete sidewalks shall be constructed in accordance with the Department's specifications for hydraulic cement concrete sidewalk, on a compacted subgrade, and include underdrains in accordance with the Department's Standard UD-3.

---

\* Rev. 3/09

- (3) Solid paver unit sidewalks shall be constructed in accordance with VDOT's Location and Design Instructional & Information Memoranda IIM-LD-218, Paver Units (Sidewalk and crosswalk), located at <http://www.virginiadot.org/business/locdes/rd-ii-memoranda-index.asp>

#### C. Sidewalks along ditch section streets

- (1) Sidewalks along ditch section streets shall be constructed in accordance with VDOT's Road and Bridge Specifications for asphalt concrete sidewalk or hydraulic cement concrete sidewalk, on a compacted subgrade, and include underdrains in accordance with VDOT's Standard UD-3, located at <http://www.virginiadot.org/business/locdes/road-and-bridge-standards.asp>. may be installed on sections that will not have direct parcel access.
- (2) Sidewalks constructed along a shoulder and ditch section shall be placed behind the ditch in a manner that will be compatible with the roadway if the roadway is converted to a curb and gutter section. (Note: Placement of sidewalk within the shoulder area is not permitted.)

## 2. Shared use paths

Shared use paths are facilities on exclusive right-of-way and with minimal cross flow by motor vehicles. Users are non-motorized and may include bicyclists, inline skaters, roller skaters, wheelchair users (both non-motorized and motorized) and pedestrians including walkers, runners, and people with baby strollers and people waking dogs. Shared use paths are most commonly designed for two-way travel, and the following guidance assumes a two-way facility is planned unless otherwise stated. When paths are planned, it is desirable to provide paths on both sides of the roadway to decrease the likelihood of children crossing the road. Pavement design for shared use paths are recommended by the Materials Division.\*

### • Separation Between Shared Use Paths and Roadways

When two-directional shared use paths are located adjacent to a roadway, wide separation between a shared use path and the adjacent highway is desirable to demonstrate to both the bicyclist and the motorist that the path functions as an independent facility for bicyclists and others. When this is not possible and the distance between the edge of the shoulder and the shared use path is less than 5 feet, a suitable physical barrier is recommended. A suitable physical barrier is defined as dense shrubbery, railing or chain link fence. Such barriers serve both to prevent path users from making unwanted movements between the path and the highway shoulder and to reinforce the concept that the path is an independent facility. Where used, the barrier should be a minimum of 42 inches high (54 inches on structures), to prevent bicyclists from toppling over it. A barrier between a shared use path and adjacent highway should not impair sight distance at intersections, and should be designed to not be a hazard to motorists or bicyclist.

---

\* Rev. 7/09

For curb and/or curb and gutter streets, the separation between from face of the curb to the edge of the shared use path shall be a minimum of 8 feet in order to meet the minimum lateral offset distance to install signs for the roadway and the shared use path.\*

- **Width and Clearance**

The paved width and the operating width required for a shared use path are primary design considerations. Under most conditions, the recommended paved width for a two-directional shared use path is 10 feet. However in rare instances, a reduced width of 8 feet can be adequate. This reduced width should be used only where the following conditions prevail:

- (1) bicycle traffic is expected to be low, even on peak days or during peak hours.
- (2) pedestrian use of the facility is not expected to be more than occasional.
- (3) there will be good horizontal and vertical alignment providing safe and frequent passing opportunities, and
- (4) during normal maintenance activities the path will not be subjected to maintenance vehicle loading conditions that would cause pavement edge damage.

Under certain conditions it may be necessary or desirable to increase the width of a shared use path to 12 feet, or even 14 feet, due to substantial use by bicycles, joggers, skaters and pedestrians, use by large maintenance vehicles, and steep grades.

A minimum 2 foot wide graded area shall be maintained adjacent to both sides of the path. A minimum 3 foot clear zone shall be maintained from the edge of the path to signs, trees, poles, walls, fences, guardrail and other lateral obstructions. Where the path is adjacent to slopes steeper than 3:1, a minimum 5 feet separation from the edge of the path pavement to the top of slope is required. Depending on the height of embankment and condition at the bottom, a physical barrier, such as dense shrubbery, railing or chain link fence, may need to be provided.

The vertical clearance to obstructions shall be a minimum of 8 feet. However, vertical clearance may need to be greater to permit passage of maintenance and emergency vehicles. In underpasses and tunnels, 10 feet is required for adequate vertical shy distance.

---

\* Rev. 7/09

Shared use paths should be designed for a selected speed that is at least as high as the preferred speed of the faster bicyclists. In general a design speed of 20 mph should be used. Long grades should be kept to a minimum. Grades greater than 5 percent are undesirable because the ascents are difficult for many bicyclists to climb and the descents cause some bicyclists to exceed the speeds at which they are competent or comfortable. In locations where grades exceed 5 %, Table 5 shows recommended maximum grade lengths.

**TABLE 5 – MAXIMUM GRADE LENGTHS FOR SHARED USE PATHS**

5 – 6%	For up to 800 feet
7%	For up to 400 feet
8%	For up to 300 feet
9%	For up to 200 feet
10%	For up to 100 feet
11+%	For up to 50 feet

Further design details for shared use paths may be found in [Section A-5 BICYCLE FACILITY GUIDELINES](#) of VDOT's Road Design Manual.

3. Pedestrian tunnels
  - a. Pedestrian tunnels to separate pedestrian crossings from roadway traffic are being encouraged by some localities to improve pedestrian safety on high volume streets. The Subdivision Street Requirements provide criteria for VDOT acceptance of these pedestrian tunnels under certain conditions. All underpass structures intended for pedestrian use, whether they are accepted for maintenance as part of the roadway or accepted under the terms of an agreement should have the following characteristics:
    - (1) Have entrances visible from the side of the roadway above.
    - (2) Be aligned to the pedestrian corridor such that the interior of the tunnel is visible to pedestrians from a distance of not less than 25 feet and preferably for its entire length.
    - (3) If located at a school, be equipped with security gates so that school authorities may regulate the hours it is available for use.

- b. All underpass structures intended for acceptance of maintenance by the Department as an integral part of the roadway, even if some features are to remain the responsibility of local government, should also include the following:
- (1) Have a grade not greater than 3%.
  - (2) Have a non-skid paved surface comparable to the finish of a sidewalk.
  - (3) Have continuous handrails.
  - (4) Have a clear height not less than 8 feet.
  - (5) Have a clear width, exclusive of any area used or reserved as a utility corridor, not less than 10 feet.
  - (6) Have security lights with explosion proof fixtures if the tunnel is more than 25 feet in length or if the tunnel is available for use after dark.
  - (7) Be accessible to persons with disabilities from sidewalks associated with the roadway above or, as an alternative, by a circuitous route.
  - (8) Pedestrian ramps should be provided at all pedestrian separation structures.
  - (9) When warranted and possible, a stairway can be provided in addition to a ramp. Ramps should be deleted only when it would be infeasible for mobility-limited persons to reach the pedestrian separation structures due to unusual topographical or architectural obstacles or when alternate safe and reasonably convenient means are provided to cross the highway.
  - (10) The ramp should have a maximum slope of 12:1 with a maximum rise of 30 in. between landings. Landings should have a minimum length of 5 ft and should be of sufficient width to allow wheelchairs to maneuver.

#### 4. Bicycle lanes

On local streets, bicyclists should be considered a normal part of the vehicle mix on the street. On collector roads, bike lanes may be established with appropriate pavement markings and signing. Bike lanes should be one-way facilities and carry bike traffic in the same direction as adjacent motor vehicle traffic. See [Appendix A, Section A – 5 – BICYCLE FACILITY GUIDELINES](#).

The recommended width of a bike lane is 5 feet from the face of a curb to the bike lane stripe. If parking is permitted, the bike lane should be placed between the parking area and the travel lane and have a minimum width of 5 feet. Bike lanes should never be placed between the parking lane and the curb line.

Further design details for Bicycle lanes may be found in [Section A-5 BICYCLE FACILITY GUIDELINES](#) of VDOT's Road Design Manual.

#### 5. Non-compliant sidewalks

As indicated in the Subdivision Street Requirements, non-compliant sidewalks that are not built in accordance with these standards or meander on and off the right of way may be permitted; however, the Department will not accept responsibility for their maintenance. A permit, which clearly specifies the applicant's responsibility for the sidewalk's maintenance and related activities, shall be obtained from the Department to the extent it encroaches upon the street's right-of-way. The permit applicant shall be a county, incorporated town, or other entity, which has perpetual maintenance capability. These sidewalks may be constructed of asphalt, concrete, gravel, or other stabilizer convenient to the applicant.

### J. BRIDGE AND CULVERT DESIGN CRITERIA

#### 1. Loading

All bridges and culverts shall be of HS 20-44 loading or alternate military loading, or both, in accordance with the current AASHTO Bridge design specifications and VDOT modifications. To facilitate the Department's review, all pertinent calculations for a structure's design shall be submitted with each bridge plan or other nonstandard drainage structure.

#### 2. Width

Clear roadway widths of all structures shall be in accordance with the Department's design manual.

## K. ROADWAY DRAINAGE

### 1. Policy and Procedures

All drainage facilities shall be designed in accordance with VDOT's Drainage Manual and supplemental directives as amended. VDOT's Location and Design Division Instructional and Informational Memorandum IIM-LD-121 Pipe Criteria and Drainage Instructions, located at <http://www.virginiadot.org/business/locdes/rd-ii-memoranda-index.asp> and the Virginia Erosion and Sediment Control Handbook, located at [www.dcr.virginia.gov](http://www.dcr.virginia.gov) shall also be used in designing drainage systems.

Low Impact Development (LID) Techniques such as Buffers Strips, Bioretention, Rain Gardens, Vegetated Swales, and Tree Preservation should also be considered. The use of LID practices offers both economical and environmental benefits. LID measures result in less disturbance of the development area, conservation of natural features and can be less cost intensive than traditional stormwater control mechanisms. Cost savings for control mechanisms are not only for construction, but also for long-term maintenance and life cycle cost considerations.\*

For additional information on LID techniques see DCR's Virginia Stormwater Management Program website at: [http://www.dcr.virginia.gov/soil\\_and\\_water/stormwat.shtml](http://www.dcr.virginia.gov/soil_and_water/stormwat.shtml), U.S. EPA's Low Impact Development website at: <http://www.epa.gov/nps/lid/> and The National Resource Defense Council website at <http://www.nrdc.org/water/pollution/storm/chap12.asp>.

### 2. Criteria

Standards appropriate to the functional classification of the street and the potential impact on adjacent property shall apply.

### 3. Design

Specific reference is made to the following design requirements:

- a. Roadside and median ditches should provide sufficient hydraulic capacity to contain the estimated runoff from a 10-year frequency storm. The estimated runoff and attendant velocity for the 2-year frequency storm is to be used for determining the needs, type and dimensions of special ditch lining for erosion control. Geometric configurations shall conform to appropriate safety standards.

---

\* Rev. 7/09

Where standard ditches have insufficient capacity for the 10-year runoff, a storm sewer system shall be provided. Open channels may be considered in lieu of a storm water system, if their construction can be accomplished without creating a hazard or condition detrimental to the appearance of the subdivision.

- b. An acceptable easement shall be provided from all drainage outfalls to a natural watercourse, as opposed to a swale (See 24 VAC 30-92-10\* for definitions). The Department normally accepts and maintains only that portion of a drainage system that falls within the limits of the dedicated right of way for a street. The Department's responsibility to enter drainage easements outside of the dedicated right of way shall be limited to undertaking corrective measures to alleviate problems that may adversely affect the safe operation or integrity of the roadway. In the event drainage to a natural watercourse is not accomplished or is interrupted, an acceptable agreement from the governing body may be considered as an alternative to providing an easement to a natural watercourse, provided the agreement acknowledges that the Department is neither responsible nor liable for drainage from the roadway.
- c. Curb drop inlets – the spread of water on the pavement shall be limited to the width of one-half of the travel lane and the gutter width (if any) in each direction or 8 to 10 feet from the face of curb, whichever is less, for a rainfall intensity of 4 inches per hour.
- d. Where the roll-top or mountable curb and gutter section is used, drop inlets must be spaced so that the 10-year frequency gutter flow does not exceed a four inch depth at the face of curb.
- e. Storm Sewers should be designed to convey the 10-year runoff without surcharge; however, the system should be designed for the 50-year runoff and checked for the 100 year runoff in situations where it would be necessary to prevent flooding of interstate highways, underpasses or other depressed roadways where ponded water can only be removed through the storm sewer system.
- f. Storm Sewer System Pipe sizes – 15" pipe or equivalent elliptical shape shall be considered the minimum acceptable size. 12" or equivalent size may only be used as the initial pipe in a system or as a lateral line when necessary, provided there is 50 ft or less between access points.
- g. Access points – Generally, distance between points of access in storm sewer trunk lines shall be limited, based on pipe diameter, to:
 

12" pipes,	50 feet
15" to 42" pipes,	300 feet
48" and larger pipes,	800 feet

---

\* Rev. 3/09



4. Documentation

All drainage design computation shall be complete, properly documented and presented to the District Administrator's Designee\* for review.

5. Storm water management

All storm water management facilities located on the right of way must be designed in accordance with Chapter 11 of the VDOT Drainage Manual. See the Secondary Street Acceptance Requirements to determine the need for any special agreements related to stormwater management.

6. Dams

In addition to the VDOT Drainage Manual, all dams must be designed in accordance with all applicable provisions of the Department of Conservation and Recreation's Virginia stormwater Management Handbook and Virginia's Dam Safety program, which is administered by the Department of Conservation and Recreation located at ([www.dcr.virginia.gov](http://www.dcr.virginia.gov)) Pertinent information is posted on their web site. See the Subdivision Street Requirements to determine the need for any agreements related to dams.

**L. RIGHT-OF-WAY**

1. Width

The minimum width of right of way shall be sufficient to accommodate all roadway elements, including pedestrians, multiuse trails, bicyclist, shared use paths and the clear zone and extend at least one (1) foot behind any feature intended to be maintained by VDOT as part of the roadway. However, the minimum width of right of way shall be no less than 30 feet. As indicated in the Secondary Street Acceptance Requirements, easements may be used in lieu of dedicated right of way to accommodate slopes and sight distances.

Dedicated right of way for roadways to the extent they occupy dams is not acceptable. All such right of way shall be platted as an ingress/egress easement.

2. Spite strips

Plans that include a reserved or "spite" strip which prohibits otherwise lawful vehicular access to a street from the adjacent properties, whether within or outside the subdivision, will not be approved.

---

\* Rev. 3/09

## **SECTION B(1) – 5 – OTHER DESIGN CONSIDERATIONS**

### **A. CLEAR ZONE** (i.e. Setback for non-breakaway fixed objects)

Except as may be authorized by land use permit, the right of way along public streets and highways maintained by VDOT must remain clear of all obstacles that are not designed to break away under impact. For the purposes of this section, breakaway structures are defined as a single 4"x4" square or 4" diameter wooden post or a standard strength, metal pipe post no greater than a 2" diameter. When curbing is used, the clear zone is measured from the face of the curb, except where a bike lane or parking lane exists between the curb and the traveled way. In such a case, clear zone may be measured from the edge of the traveled way. For shoulder and ditch sections, clear zone is measured from the edge of **travel way\***.

Mailboxes and newspaper boxes may be placed on VDOT right of way. Placement should not interfere with safety, maintenance and use of the roadway. Support structures for multiple mailboxes shall be designed and constructed in accordance with VDOT's Road and Bridge Standard RFD-1 located at <http://www.virginiadot.org/business/locdes/road-and-bridge-standards.asp>. However, lightweight newspaper boxes may be mounted on the side of the support structure. Breakaway structures noted above will be acceptable as a mailbox post.

Traffic volume, operational or design speed of the street, and the typical cross section of the street determines the required clear zone. The geometric design Tables 1, 2 and 3 in Section B-3-Roadway Geometric Design Criteria provide clear zone requirements for subdivision streets. Any structures or landscaping, including fences, stone or brick mailbox posts, columns or walls that do not meet breakaway requirements may not be located within the clear zone and will require review by the **District Administrator's Designee** to be placed on the right of way. If approved by the **District Administrator's Designee**, a land use permit must be issued for any such obstacle. However, no obstacles, even if they meet breakaway requirements, shall be placed within the 3-foot clear zone of a shared use path. For curb and gutter streets with parking lanes, the clear zone is accommodated within the parking lane. However, VDOT has established a 3' minimum setback requirement behind the curb for the placement of signs in accordance with the MUTCD, Part 2. See Note 2 on Table 1 in Section B(1)-3-Roadway Geometric Design Criteria.

---

\* Rev. 3/09

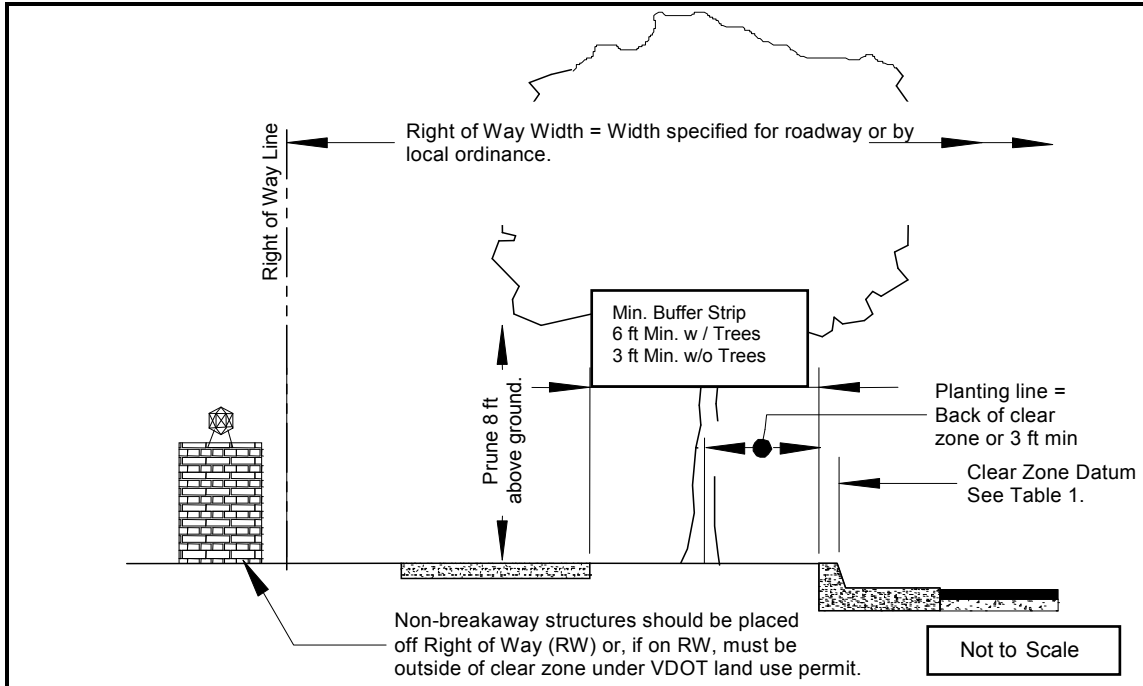

**FIGURE 10 – SETBACK DETAILS WITH CURB AND GUTTER**

Note: Driveway entrance curbing, regardless of height, shall not be permitted past sidewalks or within the area 3 feet behind curb and gutter.

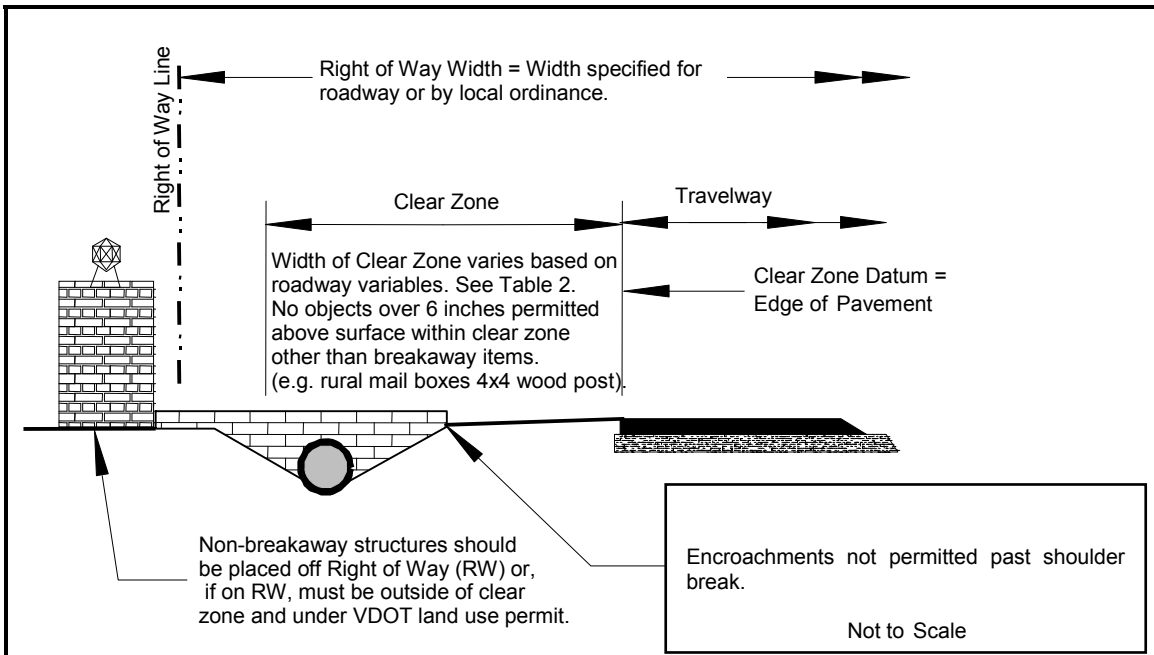

**FIGURE 11 – SETBACK DETAILS WITH SHOULDER AND DITCH**

## **B. GUARDRAIL**

Guardrail shall be provided and installed by the developer as necessary for the safety of the traveling public as determined by the **District Administrator's Designee**.<sup>\*</sup> Plans should indicate proposed guardrail location. Generally, when fill slopes are 3:1 or flatter, a barrier is not required unless there are hazardous obstacles within the clear zone limits. The developer is encouraged to examine alternatives that eliminate potential hazards in order to avoid the need for guardrail.

In urban and suburban settings with speeds of 45 mph or less that include curb or curb and gutter, the use of guardrail is not recommended. Standard CG-6 is normally used in these areas and is referred to as barrier curb because it has a 6" vertical face and is intended to discourage motorists from deliberately leaving the roadway. Even when mountable curb is used in suburban settings, it is impractical to install guardrail in an attempt to protect pedestrians walking along sidewalks due to the lack of accessibility caused when placing guardrail and terminals adjacent to accessible routes. Sometimes hazards, such as ponds or steep embankments, which need to be shielded, exist on subdivision streets with sidewalk/ sidewalk space. In situations like this, guardrail can be placed behind the sidewalk.

The use of guardrail types that are aesthetically compatible with the surrounding areas should be considered. One acceptable type is "Corten" or weathering steel rail with treated timber post. Alternate types may be considered provided they (i) conform to applicable VDOT standards or the criteria prescribed in the National Cooperative Highway Research Program Report 350, (ii) blend in with their surroundings and (iii) do not create an undue maintenance problem.

## **C. TRAFFIC CONTROL**

All plans should indicate appropriate traffic control signage and devices as designated by the Manual on Uniform Traffic Control Devices (MUTCD) and the Virginia supplement to the MUTCD.

## **D. STREETScape**

Development trends promote the use of trees, sidewalks, bicycle facilities, and shared paths adjacent to but typically set back from vehicle corridors. Trees may also be proposed within unpaved medians and center islands in cul-de-sac designs. Landscaping within the right of way is often allowed by land use permit and maintained by the permittee.

---

<sup>\*</sup> Rev. 3/09

Planting strips, located between the curb and sidewalk and parallel with the street, shall be 6 feet or more in width. Care should be used to ensure that larger planting strips do not push pedestrian crossing areas back from the intersections by requiring a larger curb radius. To maintain sight lines, trees and other objects should be restricted from corners for distances of 30 feet on all sides. Along all planting strips, the area between 2 and 7 feet above ground should be maintained as a clear zone to preserve sight lines and accommodate pedestrians.

Trees, landscaping, and other encroachments onto the right of way can obscure pedestrians or other vehicles preparing to enter the roadway from adjacent property or side streets. To protect the safety of pedestrians, bicyclist, and motorists alike, it is appropriate for vehicle operators to have an unobstructed view along the full length required by the sight distance triangle. On-street parking is considered a temporary condition and is an exempt factor.

When trees are planted along streets, especially in association with sidewalks, species selection is critical. When attracted to fruits, nuts and berries produced by some species, congregations of birds may cause potentially undesirable conditions for pedestrians. Also, species that leach sap tend to damage the finishes on parked cars and, when wet, the leaves of some species may damage automotive finishes.

## **E. LANDSCAPE CONSIDERATIONS**

Listed below are trees that have been successfully used as street trees in Virginia. This list is only general guidance as to the type of tree to be considered for street plantings, and should not be considered an exclusive list of approved trees for landscaping. Other considerations should be made with any landscape plan.

Due to the constant improvement of varieties as well as the spread of disease and plant pathogens via interstate and intrastate trade, no tree should be utilized without the verification of local factors. Thus, developers or their representatives should have their plan prepared by a local certified landscape architect, and/or confirmed by a certified arborist, nurseryman, or agricultural extension office for advice on site suitability with regard to plant hardiness, soils, soil moisture, available root zone, exposure, known diseases in the area, etc.

A general list does not take into consideration the fact that Virginia spans six temperature zones. Trees listed are not all appropriate for all temperature zones. The temperature range of areas in which a plant performs the best is defined as its "hardiness zone." Thus, while the list below represents a broad array of possible species, it does not indicate any division of use based upon "hardiness zone."

Actual species selection for a given project is often based upon availability. It is strongly suggested, therefore, that developers or their representatives check on availability of species prior to submitting a plan as to prevent last minute changes to the contract and the possible provision of undesirable species.

Considerable care should be exercised in the selection of plantings for placement within the proximity of utilities and should be coordinated with the utility companies potentially affected to ensure the selection of species will be compatible with the needs of the utility companies.

- a. Medium to Large Street Trees: These trees are a few examples of perhaps hundreds that have been shown to have good qualities for use as "Street Trees," such as less obstructive leaf litter, mostly due to a smaller and/or thinner leaf structure. Though all trees will have some amount of leaf drop and other "litter", these selections have shown superior form and tolerance of urban conditions that should outweigh concern over other issues. These trees may be placed in planting strips or medians provided they are located outside the clear zone; however, care should be taken to ensure these trees have space for adequate root development.

- |                          |                            |
|--------------------------|----------------------------|
| • Acer rubrum            | Red Maple                  |
| • Acer saccharum         | Sugar Maple                |
| • Betula nigra           | River Birch (Single Trunk) |
| • Fraxinus pennsylvanica | Green Ash                  |
| • Fraxinus americana     | White Ash                  |
| • Ginko biloba           | Ginko (Male Only)          |
| • Platanus acerifolia    | London Planetree           |
| • Quercus phellos        | Willow Oak                 |
| • Quercus palustris      | Pin Oak                    |
| • Tilia cordata          | Little leaf linden         |
| • Ulmus parvifolia       | Lacebark Elm               |
| • Zelkova serrata        | Zelkova                    |

- b. Small to Medium Street Trees: These trees are also suitable for street tree planting where overhead utilities may be nearby, thus requiring a smaller crown. These trees may be planted in the planting strip between the roadway and the sidewalk, provided they are outside the clear zone.

- |                            |                              |
|----------------------------|------------------------------|
| • Cercidiphyllum japonicum | Katsuratree                  |
| • Pistacia chinensis       | Chinese Pistache (Male Only) |
| • Acer buergerianum        | Trident Maple                |
| • Koelreutaria panniculata | Golden Raintree              |
| • Quercus accutissima      | Sawtooth Oak                 |

- c. Flowering Trees suitable for accent or focal area: While having a low branching pattern, these trees are generally large enough at maturity to reach above the height above a pedestrian, or compact enough to remain within a confined space. Care should be taken when locating very low branched or multi-stem varieties as not to obstruct sight lines, and to keep heavily fruiting varieties away from sidewalks. These trees may be planted in the planting strip between the roadway and the sidewalk.

- Aesculus x carnea                      Red Horse Chestnut
- Aesculus parvifolia                      Bottlebrush Buckeye
- Amelanchier canadensis                      Serviceberry
- Cercis canadensis                      Eastern Redbud
- Cercis chinensis                      Chinese Redbud
- Cornus florida                      Flowering Dogwood
- Cornus kousa                      Korean Dogwood
- Chionanthus virginicus                      White Fringetree
- Halesia tetraptera                      Carolina Silverbell
- Lagerstromia indica                      Crape Myrtle
- Improved fruitless varieties of Pyrus calleryana  
such as “Chanticleer” or “Cleveland Select”
- Prunus yedoensis                      Yoshino Cherry
- Prunus serrulata                      Kwanzan Cherry

- d. Other Large Trees suitable for use in large open spaces: These trees are appropriate for use where setbacks are available for the growth of very large trees; where trees with attractive qualities other than “Street Tree” form is desired; where bark texture and color for seasonal interest is desirable; and/or where leaf litter will not obstruct storm drainage, or drop onto a sidewalk. Such species, while appropriate for the backdrop of a subdivision entrance, or other open “common space”, would not, however, be desirable between a sidewalk and street.

- Betula nigra                      River Birch (Multi-Trunk)
- Cedrus deodora                      Deodar Cedar
- Celtis occidentalis                      Common Hackberry
- Platanus occidentalis                      Sycamore
- Liriodendron tulipifera                      Tulip Poplar
- Magnolia grandiflora                      Southern Magnolia
- Juniperus virginiana                      Red Cedar

This list literally represents thousands of new and improved varieties and cultivars of available species in the industry. For this reason, only the common or “generic” species names are given above. Any selection must take into consideration all the factors of a given site, plant availability, and conform to any applicable local ordinance as well as these guidelines. These considerations should be confirmed by a local expert.

## F. TRAFFIC CALMING

During street layout and design, the issue of traffic calming should be considered. Early consideration can minimize future speeding problems and improve the livability of the neighborhood. If the street layout cannot be designed to encourage target speeds, traffic calming treatments may be appropriate. The type of treatment chosen for incorporation in the design depends on the function and traffic volume of the roadway segment.

Subdivision streets shall be designed to in accordance with Geometric Design Standard Tables 1, 2, and 3 in this appendix. This can be accomplished with attention to three major design areas – the width of the paved roadway surface, the length of tangent sections and the vertical grade.

The width of pavement should be the minimum to safely accommodate the proposed traffic. If this is not practical for other reasons, the road width can also be restricted at specific points through the use of chokers or raised median islands.

Tangent lengths should ideally not exceed 500 feet. Studies indicate that operating speeds were 30 mph or less when the tangent sections were no longer than 500 feet. Long tangent sections can be segmented by conditions that require a complete stop, such as T intersection or by conditions that require reduced speeds such as a traffic calming device. Devices that are suggested for new subdivisions with an average daily traffic between 600 and 4,000 vehicles per day include roundabouts, chokers, raised median/island, crosswalk refuges or raised pedestrian crosswalks.

Steep downgrades should be avoided in subdivision street design as vehicle speeds tend to increase on downward slopes and vehicles can quickly exceed desirable speeds. Speed humps should be avoided in favor of raised crosswalks. Four-way stop conditions should be avoided on low volume streets because there will be a tendency for the stop to be ignored and that has potential to train drivers that 4-way stops don't really mean "stop." Any proposal for four-way stops must be reviewed by the District Traffic Engineer.

Further design details for all types of traffic calming measures may be found in VDOT's Traffic Calming Guide. Since the Traffic Calming Guide primarily represents retrofit designs, not all traffic calming design features in the guide are appropriate for new construction. Figure 12 illustrates certain types of traffic calming treatments that are appropriate for new construction.

Bulb-outs are traffic-calming devices that narrow the street by widening the curb and sidewalk, landscaped planting strip, or parking area. This device works well when constructed at intersections or at mid-block locations to make the street appear narrow thereby reducing speeds.\*

---

\* Rev. 7/09



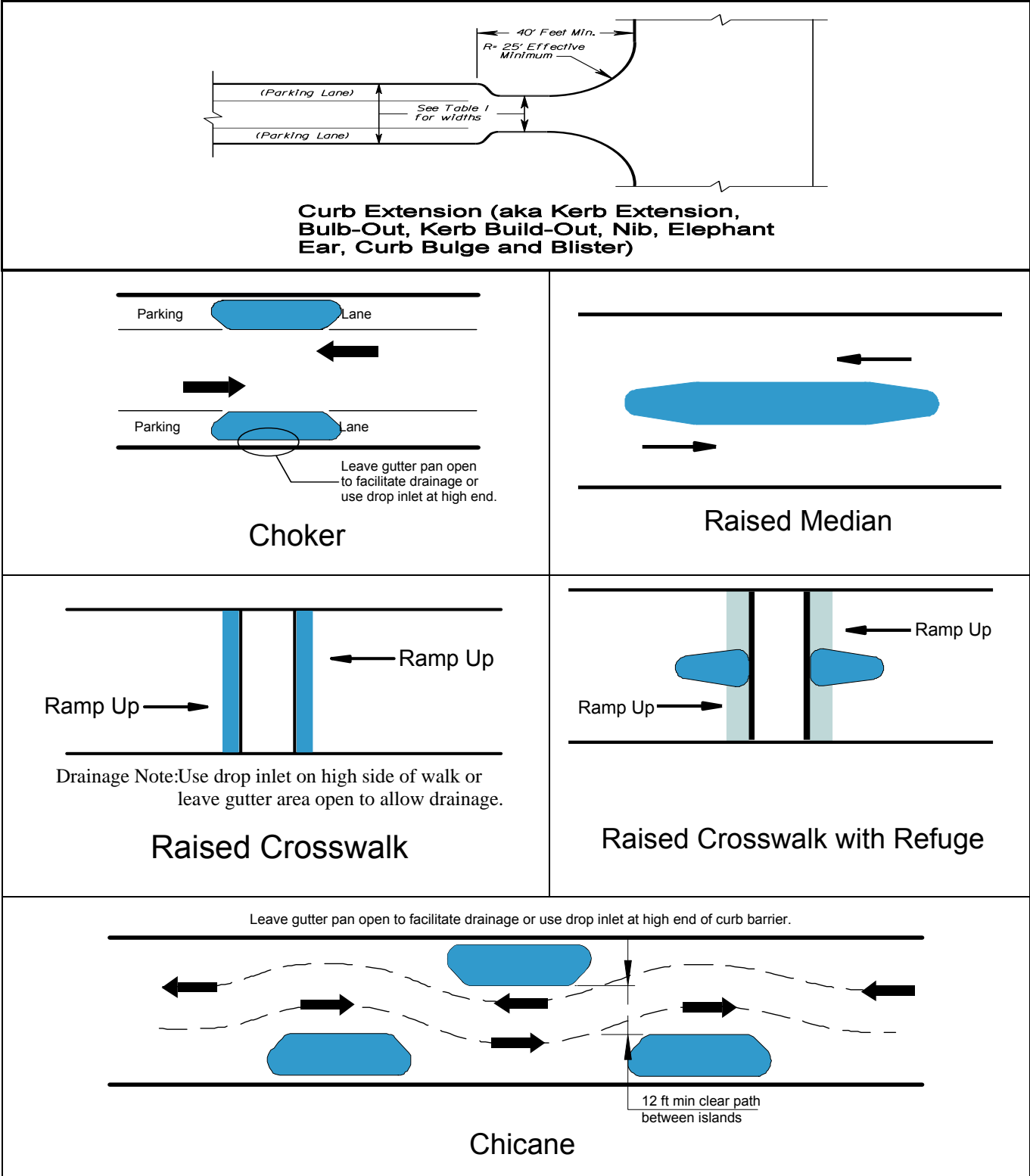

**FIGURE 12 – TRAFFIC CALMING DETAILS\***

\* Rev. 7/09

## G. ROUNDABOUTS

Roundabouts are also used at intersections to control traffic as well as to calm traffic. VDOT recognizes that roundabouts are frequently able to address safety and operational objectives better than other types of intersections. Therefore, it is VDOT policy that roundabouts be considered when a project includes reconstructing or constructing new intersection(s), signalized or unsignalized. The Engineer shall provide an analysis of each intersection to determine if a Roundabout is a feasible alternative based on site constraints, including right of way, environmental factors and other design constraints. The advantages and disadvantages of constructing a roundabout shall be documented for each intersection. When the analysis shows that a roundabout is a feasible alternative, it should be considered the Department's preferred alternative due to the proven substantial safety and operational benefits.

Roundabouts should not be considered as a feasible alternative when the following criteria exist:\*

- Where adequate horizontal and/or vertical approach sight distances cannot be met.
- When there are signalized intersections in close proximity to the proposed roundabout.
- Where high volume entrances are in close proximity (within 100') to the outer edge of the inscribed diameter.
- Where left turns are not the predominant turning movement.
- Has been deemed unsuitable by the District or Central Roundabout Review Committee.

The maximum daily service volume of a single-lane roundabout varies between 20,000 and 26,000 vehicles per day (2,000 -2,600 peak hour volume), depending on the left-turn percentages and the distribution of traffic between the major and minor roads. Roundabouts typically handle higher volumes with lower vehicle delays (queue) than traditional intersections at capacity.

Roundabout designs shall be based on Federal Highway Administration Publication Number FHWA-RD-00-067, Roundabouts: An Informational Guide at <http://www.tfrc.gov/safety/00068.htm> and <http://www.tfrc.gov/safety/00068.pdf>. Additional information can also be found in VDOT's Roundabout Brochure at <http://www.virginiadot.org/info/faq-roundabouts.asp>. See Figure 13 - Roundabout Details. When roundabout design is proposed, the District Administrator's Designee should consult the District Location and Design Engineer.

Common characteristics of acceptable roundabouts include (a) a domed center that is sufficiently clear to not compromise sight distance and (b) a paved traversable apron not less than 4 feet in width, the radius of which is sufficient to serve the turning radius of school buses and single unit design vehicles. If the

---

\* Rev. 7/09

percentage of trucks anticipated to use the road exceeds 5%, that radius should be sufficient to serve those vehicles.

Example Plan Sheets for Typical Single Lane Roundabouts can be accessed at: <https://www.nysdot.gov/portal/page/portal/main/roundabouts/guide-engineers/examples>.

**For the approval process of roundabouts see Appendix “C”.**

**The submittal should contain and depict the following criteria:**

- Approach grades and sight distances.
- Inscribed diameter of circulatory roadway.
- Design vehicle (WB-50 or WB-67).
- Apron width, circulatory lane width and approach lane widths.
- Approach lane deflection and length of splitter islands.
- Pedestrian crossing locations.
- Pavement markings.
- Signing.
- Roadway Lighting (desirable).
- Nearest entrance locations and nature of property use.
- Initial or present and projected design year traffic count on all approaches.
- Turning movements for all directions.
- VISSIM and SIDRA Analysis on all approaches showing peak hour LOS in design year.
- Autoturn results showing off tracking of Design Vehicle.
- Is this facility designed as a bicycle Route?
- Are their accommodations made to bicyclists?

If, for some reason, the District does not have capability to run the subject computer programs, the Roundabout Committee can provide assistance upon request.

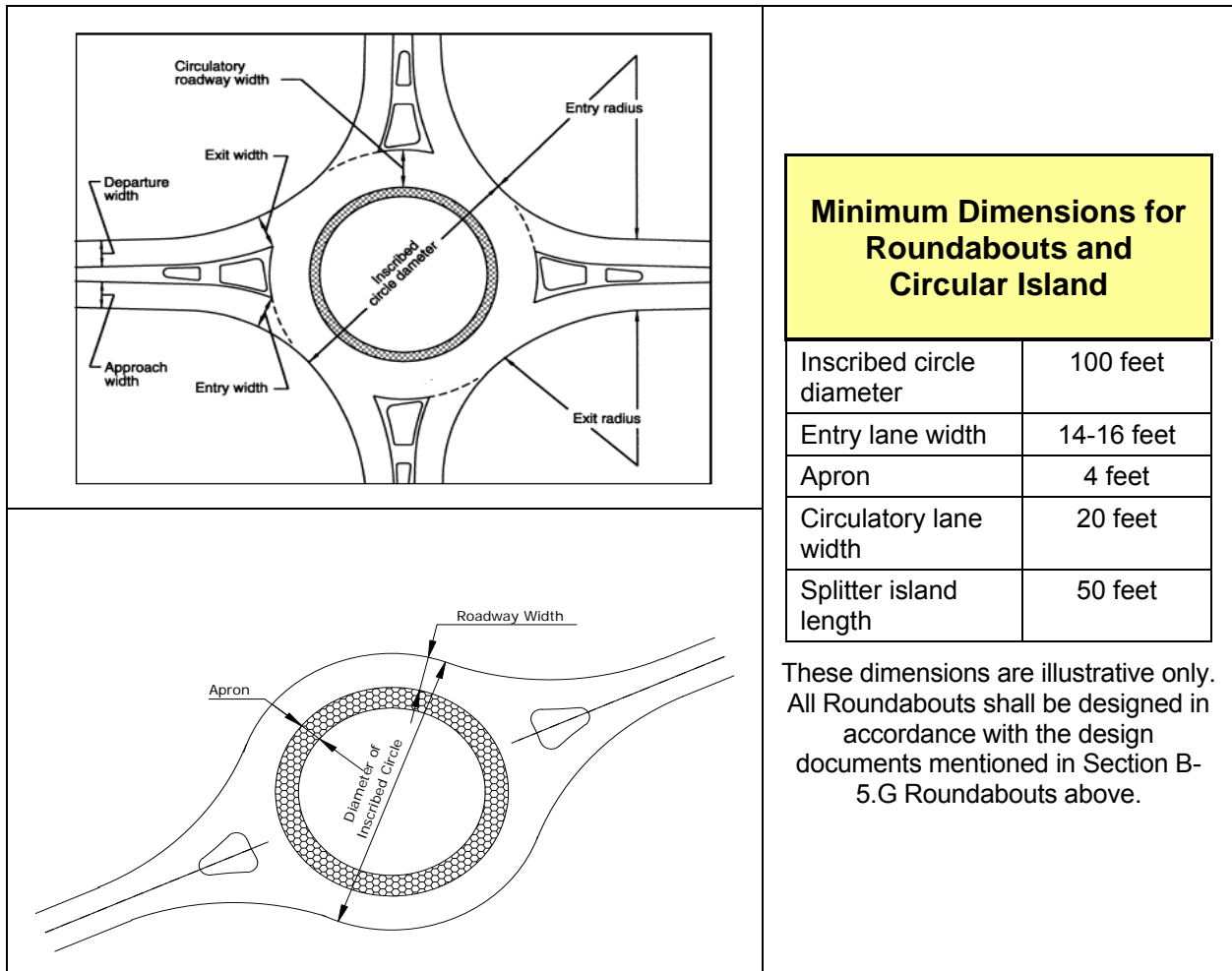

**FIGURE 13 – ROUNDABOUT DETAILS**

**H. UTILITIES**

As indicated in the **Secondary\*** Street **Acceptance** Requirements, local governments, the development community, and the utility community are encouraged to coordinate and consolidate their interests as part of the initial development plan. All utility locations should be indicated on the plans. Utility lines should be located to minimize need for later adjustment and to permit servicing such lines with minimum interference to traffic or destruction of roadway surfaces.

a. Underground utilities

The Department allows the placement of underground utilities within the dedicated right of way of streets.

\* Rev. 3/09

Underground utilities should normally be located outside of the travel lanes and desirably beyond the pavement. However, if the governing body has established adequate requirements for the design, location, and construction of underground utilities within the right-of-way of subdivision streets, including provisions that ensure adequate testing and inspection is performed to minimize future settlement, those requirements shall become the Department's requirements and govern unless those requirements conflict with a requirement of the Department.

When location of the utilities outside of the pavement area is not practical such as in high density developments incorporating the principles of new urbanism as described in 15.2-2223.1 of the Code of Virginia, such installations:\*

- (1) Are acceptable within the parking area and the shoulders along the street.
- (2) May be acceptable beneath the travel lanes of the street when provisions are made to ensure adequate inspection and compaction tests and
  - (a) Longitudinal installations and manholes are located outside of the normal travel lanes, or
  - (b) Longitudinal installations and manholes are placed in the center of an undivided roadway out of the wheel path.

However, manholes shall not be placed in sidewalk, multiuse trail, or shared use path facilities within five feet of curb ramps or within driveway entrances.

- (3) Open-cutting of hard-surfaced roadways

The Department usually prohibits the open-cutting of hard-surfaced roads except in extenuating circumstances. Therefore, all underground utilities within the right-of-way, as determined necessary by good engineering practice to serve the complete development of adjacent properties, shall be installed during the street's initial construction and prior to the application of its final pavement surface course. This shall include extensions of all necessary cross-street connections or service lines to an appropriate location beyond the pavement and preferably the right of way line.

In the event it is necessary to open the street pavement to work on utilities after the surface has been placed, additional compaction tests and paving as necessary to restore the integrity and appearance of the roadway may be required at the discretion of the District Administrator's Designee.

---

\* Rev. 7/09

(4) Cross-street conduits

To facilitate the placement of future underground utilities, cross-street conduits are encouraged with placement of such conduits occurring on each street at intersections and approximate every 1000 feet along the length of a street.

b. Above ground utilities

All above ground utilities shall be installed behind the sidewalk or as close as possible to the limits of the street's right-of-way, but shall not encroach on the sidewalk, the shared use path, or any clear zone.\*

**I. ROADWAY LIGHTING**

The installation, maintenance and operation of the lighting shall be provided by and at the sole expense of others.

VDOT will allow roadway lighting within the rights of way by land use permit only. VDOT will review and approve all roadway lighting plans regardless of maintenance and operational responsibility. On curb sections, poles shall be placed behind the curb and preferably behind the sidewalk. For shoulder sections, the pole shall be placed a minimum of 10 feet from the edge of pavement and behind the ditch line. All lighting proposed within the rights of way must be designed in accordance with the AASHTO guide for Roadway Lighting and shall meet the current Illuminating Engineering Society of North America (IESNA) Standards.

---

\* Rev. 3/09

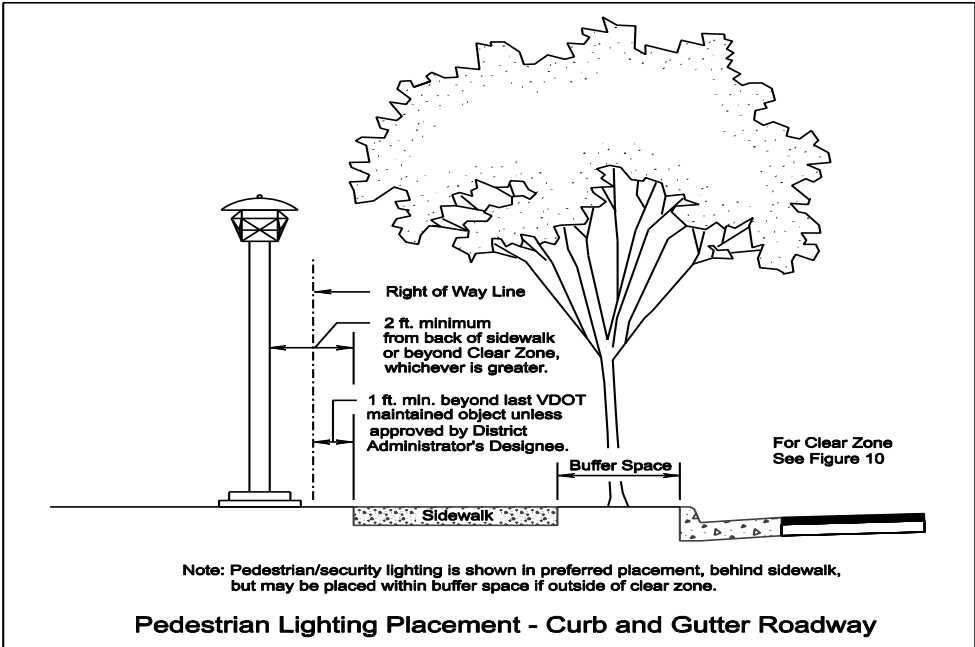

FIGURE 14 – LIGHTING ALONG CURB AND GUTTER SECTIONS\*

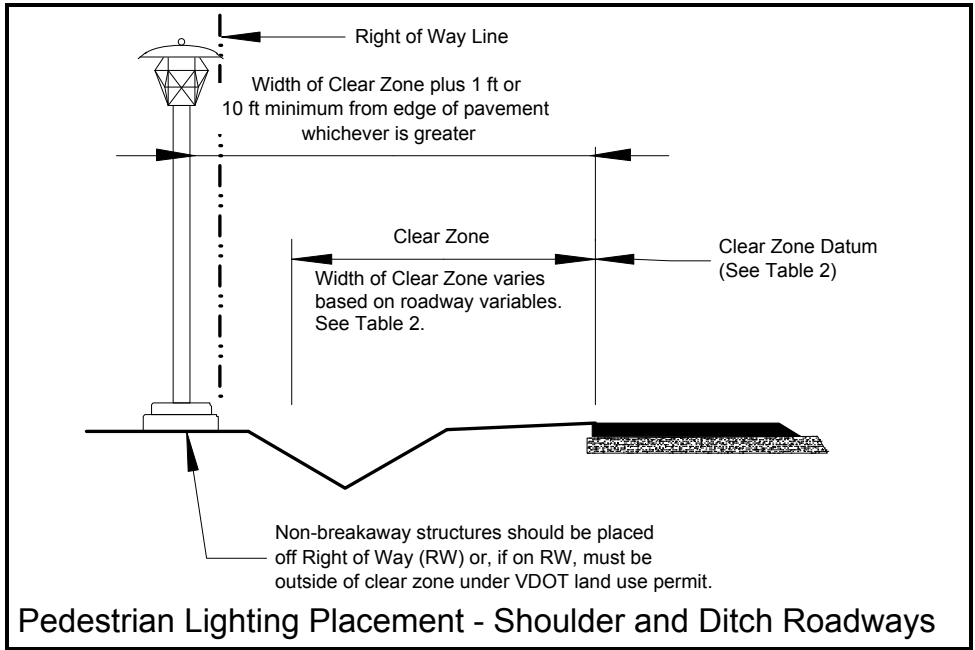

FIGURE 15 – LIGHTING ALONG SHOULDER AND DITCH SECTIONS

\* Rev. 3/09





## **SECTION B(1) – 6 – TRADITIONAL NEIGHBORHOOD DESIGN**

Any **Traditional\*** Neighborhood Development proposal should be presented to the locality and VDOT in its entirety. It is recognized that each traditional development is unique and will require individual review, discussion and approval of unique features. However, any county interested in traditional development is encouraged to submit their county wide proposal of the basic features they would like to see allowed in Traditional type development for VDOT review.

A **Traditional** Neighborhood Development is a multi use, walkable community with moderate to high residential densities and a mixed-use core. Compared with conventional suburban developments, Traditional have a higher potential to increase modal split by encouraging and accommodating alternate transportation modes. **Traditional** also have a higher potential for capturing internal trips due to the increased employment, educational, and recreational facilities located within the development, thus reducing vehicles miles traveled.

A dense network of narrower streets with reduced curb radii is a key feature of **Traditional** Neighborhood Development design. This network serves to both slow and disperse vehicular traffic and provide a pedestrian friendly atmosphere. Such alternate guidelines are encouraged when the overall design ensures that non-vehicular travel is to be afforded very practical accommodation that does not adversely affect safety considerations.

**Traditional** Neighborhood Developments have a high proportion of interconnected streets, sidewalks and paths. Street and rights of way are shared between vehicles (moving and parked), bicycles, and pedestrians. The dense network of **Traditional** Neighborhood Development streets functions in an interdependent manner, providing continuous routes that enhance non-vehicular traffic. Most **Traditional** Neighborhood Development streets are designed to minimize **the impact of** through traffic by the design of the street and the location of the land uses. Streets are designed to only be as wide as needed to accommodate the usual vehicular mix for that street while providing adequate access for moving vans, garbage trucks, emergency vehicles and school busses.

Alleys are encouraged to provide site access, though alleys will not be accepted by VDOT for maintenance in the secondary system. The alley network also ensures minimal service vehicle access on the neighborhood street. **Alley widths are to be determined by the locality.** Alley entrances should be designed in accordance with Standard CG-11 and be a minimum width of 20 feet measured from face of curb to face of curb with a minimum radius of 12.5 feet. However, the selected radius shall accommodate the anticipated type of vehicle usage.

In addition, the following features are characteristic of Traditional Neighborhood Developments and may be allowed within these subdivision guidelines.

---

\* Rev. 3/09

- A. All or most streets must be part of a dense interconnected pattern. The degree of interconnectivity should be maximized to permit multiple routes, diffuse traffic and shorten walking distances. Most Traditional Neighborhood Development streets are designed to minimize the impact of through traffic.
- B. One-way street pairs are often used. The design features for one-way streets are shown on Table 3.
- C. Large vehicular corridors are usually found within the core area and near the perimeter of the proposed development. Traditional Neighborhood Developments typically include transit availability within a 15-minute walk of most areas of the development so a good network of streets that can accommodate busses is important.
- D. All or most local streets should have short block lengths of between 250 and 500 feet.
- E. Traffic calming – Many of the previously identified traffic calming devices may be utilized in a Traditional Neighborhood Development to promote pedestrian movement. Loop streets or eyebrows are often used in Traditional Neighborhood Development and may be considered acceptable ancillary pavement areas used only with curb and gutter sections. These features are not normally considered separate streets but may be used within the internal subdivision street network and should not adjoin any existing road. See Figure 12 – Traffic Calming Details.\*
- F. Curb Extensions – Curb extensions at intersections are frequently used in Traditional Neighborhood Developments. Curb Extensions are usually found on higher volume streets where they are used to protect parking areas or reduce pedestrian crossing times. For intersections with curb extensions, a minimum 35' radius should be used as in the sketch below. Intersection chokers or curb extensions can also be used to calm traffic and to shorten the distance pedestrians must travel to cross a street.

---

\* Rev. 7/09

**SECTION B(1) – 7 – INNOVATIVE DESIGN PROPOSALS**

This Guide sets out design criteria and guidance for local subdivision streets based on VDOT standards and other applicable design references. If a development proposes use of a recognized acceptable concept or material not previously approved for VDOT use, a request shall be submitted to VDOT's District Administrator's Designee\* or designee for review. The District Administrator's Designee or designee, through consultation with appropriate divisions, will determine if the request will be approved for a VDOT maintained street. If it is determined that the non-standard item may be installed within the dedicated right of way and should be maintained by others, a permit will be required.

---

\* Rev. 3/09