

**APPENDIX C METRIC
TABLE OF CONTENTS**

SECTION C-1-DESIGN FEATURES 1

	Page
CROSSOVER SPACING	C-1
CROSSOVER GRADES	C-2
INTERSECTING CROSS ROAD GRADES.....	C-4
LEFT-TURN LANES	C-4
LEFT AND RIGHT TURN STORAGE AND TAPER LENGTHS	C-5
WARRANTS FOR LT.-TURN STORAGE LANES ON 2-LANE HIGHWAYS	C-6
DOUBLE (DUAL) LEFT-TURN LANES	C-19
CROSSOVERS WITHOUT AND WITH CONNECTIONS	C-22
INTERSECTION DESIGN	C-22
ROUNDBABOUTS:	C-23
THE APPROVAL PROCESS FOR ROUNDBABOUTS	C-23
SIGHT DISTANCE	C-36
RIGHT TURN LANES	C-42
ENTRANCES	C-43
SAFETY REST AREAS	C-45
PARKING SPACES	C-46

List of Figures

	Page
TABLE C-1-1M CROSSOVER SPACING CRITERIA.....	C-1
FIGURE C-1-1M LEFT & RIGHT TURN STORAGE & TAPER LENGTHS	C-5
FIGURE C-1-1.1M Warrants For Left-turns Storage Lanes on Four-Lane Highway	C-6
Table C-1-2M Warrants For Left-Turn Lanes on Two-Lane Highways	C-7
FIGURE C-1-1.2M Warrants For Left-Turn Storage Lanes onTwo-Lane Highways	C-8
FIGURE C-1-1.3M Warrants For Left-Turn Storage Lanes onTwo-Lane Highways	C-8
FIGURE C-1-1.4M Warrants For Left-Turn Storage Lanes onTwo-Lane Highways	C-9
FIGURE C-1-1.5M Warrants For Left-Turn Storage Lanes onTwo-Lane Highways	C-9
FIGURE C-1-1.6M Warrants For Left-Turn Storage Lanes onTwo-Lane Highways	C-10
FIGURE C-1-1.7M Warrants For Left-Turn Storage Lanes onTwo-Lane Highways	C-10
FIGURE C-1-1.8M Warrants For Left-Turn Storage Lanes onTwo-Lane Highways	C-11
FIGURE C-1-1.9M Warrants For Left-Turn Storage Lanes onTwo-Lane Highways	C-11
FIGURE C-1-1.10M Warrants For Left-Turn Storage Lanes onTwo-Lane Highways ...	C-12
FIGURE C-1-1.11M Warrants For Left-Turn Storage Lanes onTwo-Lane Highways ...	C-12
FIGURE C-1-1.12M Warrants For Left-Turn Storage Lanes onTwo-Lane Highways ...	C-13
FIGURE C-1-1.13M Warrants For Left-Turn Storage Lanes onTwo-Lane Highways ...	C-13
FIGURE C-1-1.14M Warrants For Left-Turn Storage Lanes onTwo-Lane Highways ...	C-14
FIGURE C-1-1.15M Warrants For Left-Turn Storage Lanes onTwo-Lane Highways ...	C-14
FIGURE C-1-1.16M Warrants For Left-Turn Storage Lanes onTwo-Lane Highways ...	C-15
FIGURE C-1-1.17M Warrants For Left-Turn Storage Lanes onTwo-Lane Highways ...	C-15
FIGURE C-1-1.18M Warrants For Left-Turn Storage Lanes onTwo-Lane Highways ...	C-16
FIGURE C-1-1.19M Warrants For Left-Turn Storage Lanes onTwo-Lane Highways ...	C-16
TABLE C-1-2.1M TRUCK ADJUSTMENTS	C-17
FIGURE C-1-1.20M Passing / Left Turn Lane on Two-Lane Highway	C-18
FIGURE C-1-2M DOUBLE LEFT-TURN LANES	C-20
FIGURE C-1-2.1M CONTINUOUS TWO-WAY MEDIAN LEFT-TURN LANES.....	C-21
FIGURE C-1-2.2M ROUNDABOUT DETAILS	C-24
FIGURE C-1-3M CROSSOVERS WITHOUT AND WITH CONNECTIONS	C-25
FIGURE C-1-4M INTERSECTION DESIGN	C-26
FIGURE C-1-5M INTERSECTION DESIGN	C-27
FIGURE C-1-5.1M MINIMUM TURNING RADIUS WB-12	C-28
FIGURE C-1-5.2M MINIMUM TURNING RADIUS WB-15	C-29
FIGURE C-1-5.3M MINIMUM TURNING RADIUS WB-19	C-30
FIGURE C-1-5.4M MINIMUM TURNING RADIUS SU	C-31
FIGURE C-1-5.5M MINIMUM TURNING RADIUS P	C-32
FIGURE C-1-5.6M MINIMUM TURNING RADIUS BUS.....	C-33
FIGURE C-1-5.7M.....	C-34
FIGURE C-1-5.8M.....	C-35
TABLE C-1-3M STOPPING SIGHT DISTANCE	C-36
TABLE C-1-4M PASSING SIGHT DISTANCE.....	C-36
TABLE C-1-5M Intersection Sight Distances along Major Road at Intersection with Minor Roads, Crossovers and Commercial Entrances	C-37
FIGURE C-16M Design controls for crest vertical curves, for stopping sight distance and open road conditions	C-39
FIGURE C-1-7M Design controls for sag vertical curves, open road conditions	C-39
FIGURE C-1-8M GUIDELINES FOR RT. TURN TREATMENT (2-LANE HIGHWAY) ..	C-40
FIGURE C-1-9M GUIDELINES FOR RT. TURN TREATMENT (4-LANE HIGHWAY) ..	C-41
FIGURE C-1-10M PRIVATE AND COMMERCIAL ENTRANCES	C-45
ACCESSIBLE PARKING AND PASSENGER LOADING ZONES	C-47
MINIMUM DIMENSIONS FOR ACCESSIBLE PARKING.....	C-47

ACCESS AISLE FOR ACCESSIBLE LOADING ZONES.....	C-47
FIGURE C-1-10.1M DESIGNS FOR ACCESSIBLE PARKING SPACES.....	C-47
FIGURE C-1-11M DESIGN GUIDE FOR SAFETY REST AREAS.....	C-48
FIGURE C-1-12M DESIGN GUIDE FOR SAFETY REST AREAS.....	C-49
FIGURE C-1-13M DESIGN FOR ANGLE PARKING OF TRUCKS	C-50
FIGURE C-1-14M DESIGN FOR PARKING SPACES	C-51

SECTION C-1-DESIGN FEATURES

CROSSOVER SPACING

Criteria Table C-1-1M shows crossover spacing and sight distance requirements to be applied on all divided highways without full control of access. The minimum sight distance requirement indicated in Table C-1-1M must be met at all crossover locations. Crossover spacing less than shown as minimum will be considered when required by intersecting public highways or streets with a current ADT of 100 or greater. Other crossovers will only be allowed after an individual traffic safety and operational study.

The following are some factors, but not all inclusive, that should be considered in the study, if applicable: Operating speed, volume of traffic for crossover and through routes, signal operation/progression, accidents with and without additional crossover, number of U-turns, weaving maneuvers, alternative solution, capacity analysis, type of vehicles such as school buses, trucks, etc. Final approval will be required by the State traffic Engineer and the State Location and Design Engineer.

DESIGN SPEED of HIGHWAY (km/h)	CROSSOVER SPACING ⊗		MINIMUM SIGHT DISTANCE (m)
	DESIRABLE (m)	MINIMUM (m)	
110	375	300	270
100	345	280	245
90	310	250	220
80	275	210	195
70	235	195	175
60	200	170	150
50	160	130	125

TABLE C-1-1M

CROSSOVER SPACING CRITERIA

Sight distance determinations apply both horizontally and vertically and are to be based on a height of drivers eye of 1.08 m and a height of object 1.08 m measured each way.

⊗ Crossover spacing is measured from center to center.*

* Rev. 7/07

All plans at the field inspection stage are to show only those crossovers at public highways and streets which meet these criteria or at other locations that preliminary planning and traffic studies have warranted. The determination of additional crossovers will be the result of field inspection recommendations of the District Administrator, the State traffic Engineer, (or other appropriate Engineer) and the State L & D Engineer.

The approval of the crossovers is the responsibility of the Engineer and the State L & D Engineer, with the final responsibility for the location of crossover layout on plans resting with the State L & D Engineer.

Plans at right of way stage are to indicate the crossovers as determined and approved by the above criteria. Any plans that are revised for crossovers during construction are to be approved as indicated above. When construction has been completed, the approval of the addition or deletion of crossovers will be the responsibility of the State traffic Engineer (or other appropriate Engineer) with the concurrence of the State Location and Design Engineer. It will be the responsibility of the Traffic Engineer to coordinate such changes with the State Location and Design Engineer in order that these revisions of crossovers may be properly recorded on the original plans.

CROSSOVER GRADES

On divided highways with depressed medians, there are generally three methods by which superelevation is determined for the opposing traffic lanes.

One method is for the median pavement edges to be held at the same, or close to the same, elevation. A second method is for each baseline elevation to be approximately the same, with a corresponding difference in elevation of the median pavement edges. The third method is for the superelevation of all lanes to be obtained along a single plane. Thus, the grade of the lane on the outside of the curve is higher than the inside lane. The various methods are illustrated below:

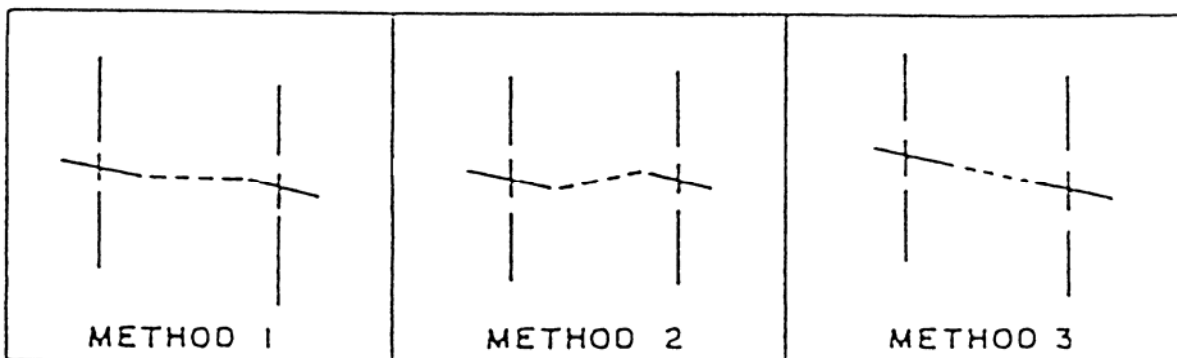

The designer is to study the requirements of each particular situation. In the case of a facility without crossovers, the first method above is generally acceptable on

superelevated curves. This will allow the median area to be properly graded without creating an adverse design situation.

Method 2 generally results in an undesirable situation and must be used with caution. In a case where a crossover is proposed, particularly in conjunction with a connecting road within the limits of a superelevated curve, the designer shall pay particular attention to the path which must be traversed by vehicles using the crossover.

In most cases, the application of the superelevation in a single plane (Method 3) is the acceptable method. This will allow a vehicle to cross from one lane to the other without negotiating several different gradients. As noted herein, this will require the adjustment of the mainline grades.

The desirable grade on a crossover is between 0.5% and 5%. The maximum grade should never exceed 10% as safe turning movements above this level are difficult. It is especially important at locations, such as truck stops and other businesses generating large vehicular traffic, that crossover grades fall in the category of less than 5%. A desirable maximum algebraic difference of a crossover crown line is 4 or 5 percent, but it may be as high as 8 percent at the locations where there are few trucks or school buses and low speeds. Additionally, sight distances must be checked for values shown in table for "Sight Distances along Major Road at Intersection with Minor Road and Crossovers and Commercial Entrances." (See Sight Distance Table C-1-5M). Any deviation from these values is to be brought to the attention of the State Location and Design Engineer.

The grade on a crossover is measured from the edge of shoulder to the edge of shoulder, unless left turn lanes are provided, in which case the grade is applied from the edge of pavement of the left turn lane to the edge of pavement of the opposite left turn lane. This is more clearly shown in the following diagram:

Determination of Grade on a Crossover



In preparing plans for field inspection, the gradient at each crossover is to be plotted graphically.

INTERSECTING CROSS ROAD GRADES

The grade of a connecting facility must be carefully studied when approaching an intersection where the mainline is superelevated.

A smooth grade tie-in is desirable, with sufficient area on a relatively flat grade for a vehicle to stop before entering the main roadway. Also, when a connection is on the outside of a superelevated curve, the grade must be designed so that the connection is visible to a driver on the main roadway desiring to turn onto the connection.

Every attempt must be made to provide an adequate area for this vehicular stoppage, giving full consideration to the horizontal and vertical sight distances.

The desirable tie-in is one that is no steeper than the pavement cross slope whether this is superelevated or the normal crown. The maximum difference between the pavement cross slope and the approach road grade shall not exceed 8% at stop intersections, or 4% at continuous-movement intersections. The stoppage area should be a minimum of 15 m before beginning the steeper grade. (See AASHTO's A Policy on Geometric Design of Highways and Streets)

LEFT-TURN LANES

As a general policy, left-turn lanes are to be provided for traffic in both directions in the design of all median crossovers on non-access controlled divided highways using controls as shown in Figure C-1-1M. Left-turn lanes should also be established on two-lane highways where needed for storage of left-turn vehicles and/or prevention of thru-traffic delay.

LEFT AND RIGHT TURN STORAGE AND TAPER LENGTHS

<u>LENGTH OF STORAGE</u>		<u>TAPER - Rural and Urban</u>	
Rural - For Design Speeds 80 km/h or Higher	*L – 60m min. (For 240 or fewer vehicles during peak hour, <u>making turn</u>)	- For Design Speeds 55 km/h or Higher	**T – 60 m Min.
- For Design Speeds Less than 80 km/h	*L – 30 m min. (For 60 or fewer vehicles during peak hour, <u>making turn</u>)	- For Design Speeds <u>55 km/h or Less</u>	**T – 60 m Min.
*Distance L to be adjusted upward as determined by capacity analysis for Left <u>and Right</u> Turn Storage.		**Tapers are to be straight-line unless local policy requires reverse curves. In congested areas the taper length may be reduced to increase storage length.	
Urban - Length determined by capacity analysis for Left <u>and Right</u> Turn Storage			

Taper rates: 8:1 for design speeds up to 30 mph and 15:1 for design speeds between 55 and 80 km/h. (Source: 2004 AASHTO Green Book , Page 716 and Exhibit 9-74).*

Note: Figures shown above were compiled using these formulas and were rounded up.

FIGURE C-1-1M

Dimension "L" to be adjusted upward as determined by Figure C-1-1.1M or by capacity analysis for left-turn storage.

A capacity analysis is defined as a detailed analysis of the location in accordance with the guidelines contained in the current issue of the Highway Capacity Manual for intersection capacity and signalization requirements.

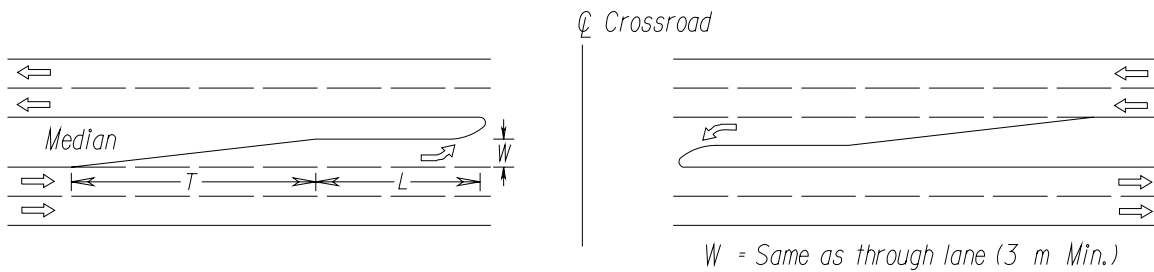

* Rev. 7/06

WARRANT FOR LEFT-TURN STORAGE LANES ON FOUR-LANE HIGHWAY

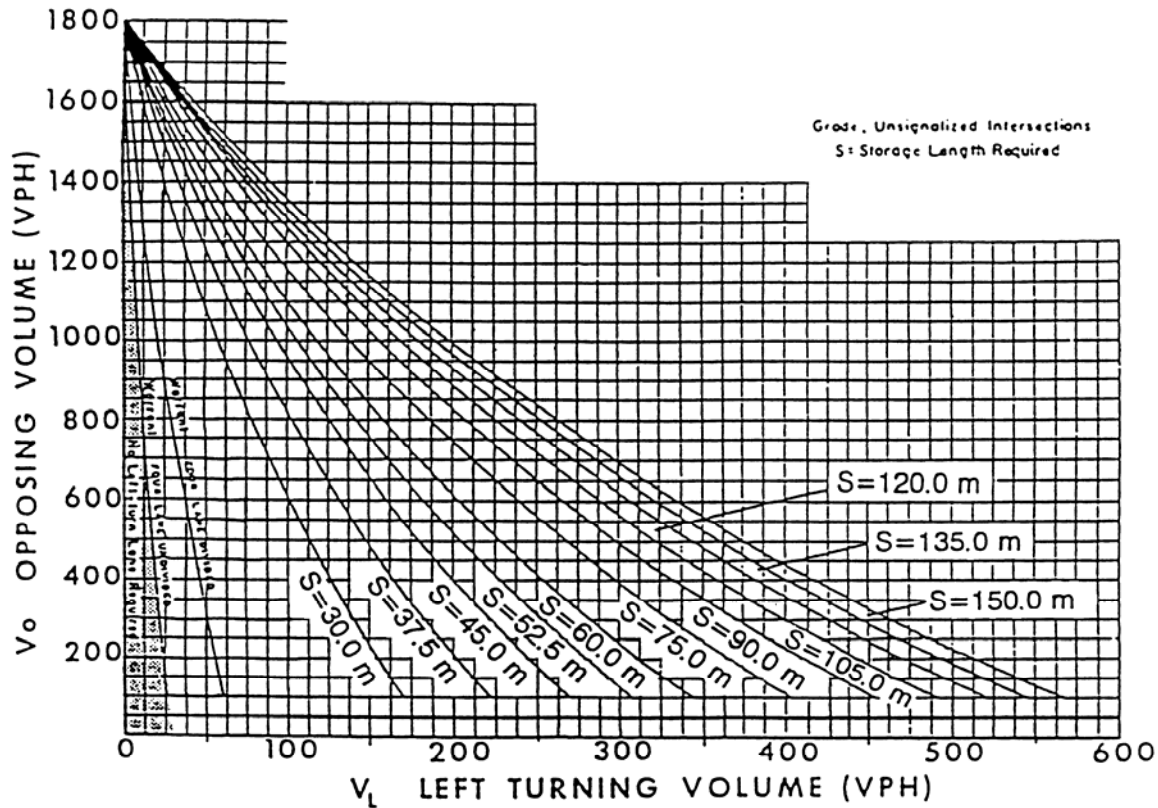

FIGURE C-1-1.1M

When the Average Running Speed on an existing facility is available, the corresponding Design Speed may be obtained from [IIM LD - 117](#).

For plan detail requirements when curb and/or gutter are used, see VDOT's [Road Design Manual](#), [Section 2E-3](#).

Left-turn lanes should also be established on two-lane highways where traffic volumes are high enough to warrant them in accordance with the guidelines shown in [Table C-1-2M](#).

WARRANTS FOR LEFT-TURN STORAGE LANES ON TWO-LANE HIGHWAYS

The warrants in [Table C-1-2M](#) are taken from the 2004 AASHTO "Green book", Page 685, Exhibit 9-75. They were derived from Highway Research Report No. 211, Figures 2 through 19, for required storage length determinations.

Deleted Information*

* Rev. 1/07

The No. 211 study was undertaken to provide consistent volume warrants for left-turn storage lanes at unsignalized intersections.

VPH OPPOSING VOLUME	ADVANCING VOLUME			
	5% LEFT TURNS	10% LEFT TURNS	20% LEFT TURNS	30% LEFT TURNS
60-km/h OPERATING SPEED / DESIGN SPEED*				
800	330	240	180	160
600	410	305	225	200
400	510	380	275	245
200	640	470	350	305
100	720	515	390	340
80-km/h OPERATING SPEED / DESIGN SPEED*				
800	280	210	165	135
600	350	260	195	170
400	430	320	240	210
200	550	400	300	270
100	615	445	335	295
100-km/h OPERATING SPEED / DESIGN SPEED*				
800	230	170	125	115
600	290	210	160	140
400	365	270	200	175
200	450	330	250	215
100	505	370	275	240

* SPEED LIMIT MAY BE USED IF APPLICABLE, I.E. ADDING LANES TO EXISTING FACILITIES.

Source: 2004 AASHTO Green Book, Page 685, Exhibit 9-75

TABLE C-1-2M
WARRANTS FOR LEFT-TURN LANES
ON
TWO-LANE HIGHWAYS

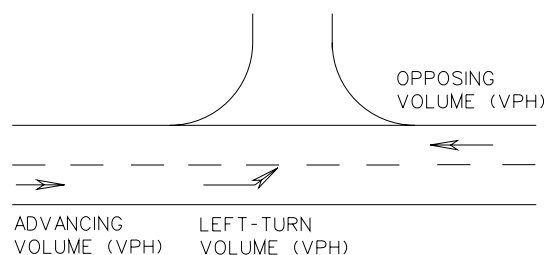

Example:

Two-lane highway with 60-km/h operating speed

Opposing Volume (VPH) - 600

Advancing Volume (VPH) - 440

Left-Turn Volume (VPH) - 44 or 10% of Advancing Volume

With opposing volume (VPH) of 600 and 10% of advancing volume (VPH) making left turns, and advancing volume (VPH) of 305 or more will warrant a left-turn lane.

Figure C-1-1.3M (page C-5.1) denotes that a 30 m storage length is required.

Figures C-1-1.2M through C-1-1.19M provide warrants for left-turn storage lanes on two-lane highways based on 5 to 30* percent left-turn volumes and operating speeds of 60, 80, and 90 km/h. Table C-1-2.1M provides the additional storage length required for 10 to 50 percent truck volumes.

Intersections with poor visibility and/or a bad accident record may require the designer to use engineering judgment when volume conditions alone do not warrant a storage lane.

* Rev. 7/06

WARRANT FOR LEFT-TURN STORAGE LANES ON TWO-LANE HIGHWAYS

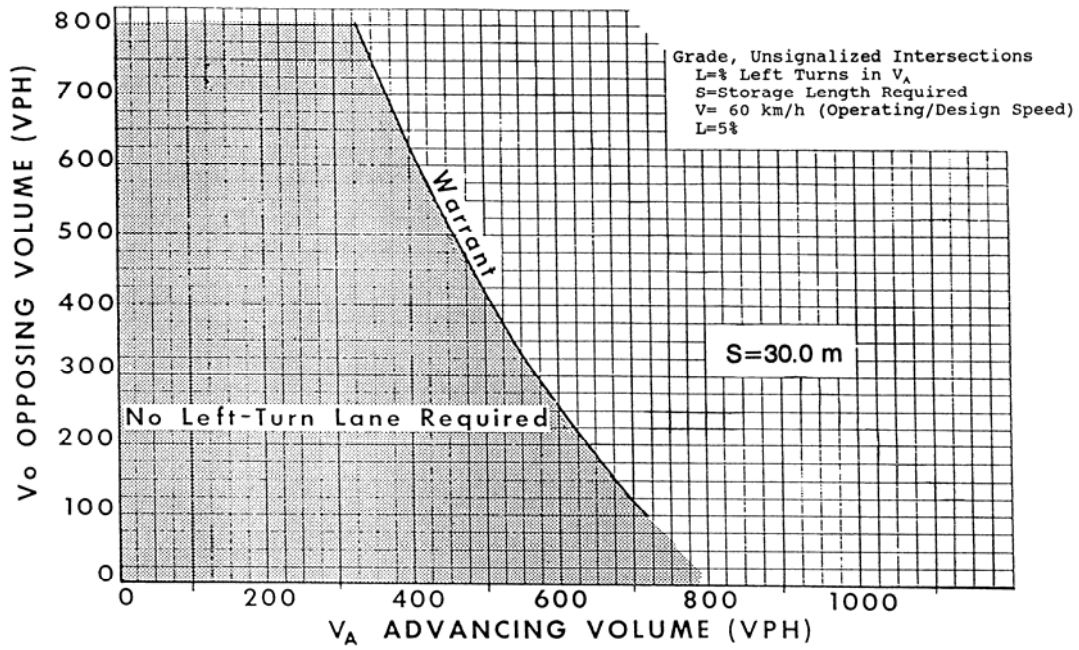

FIGURE C-1-1.2M

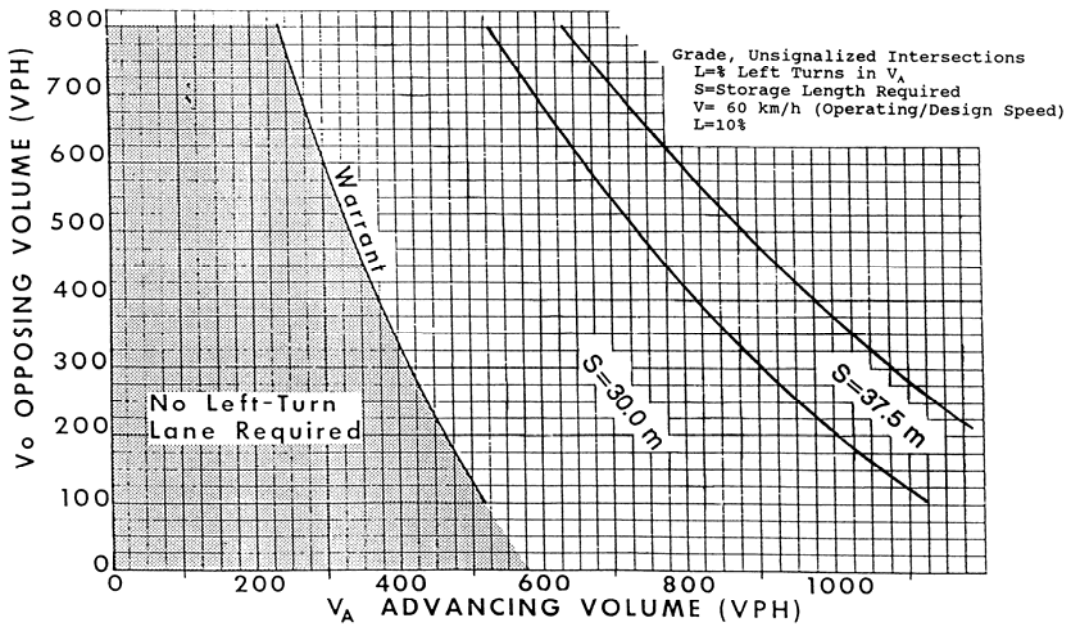

FIGURE C-1-1.3M

WARRANT FOR LEFT-TURN STORAGE LANES ON TWO-LANE HIGHWAYS

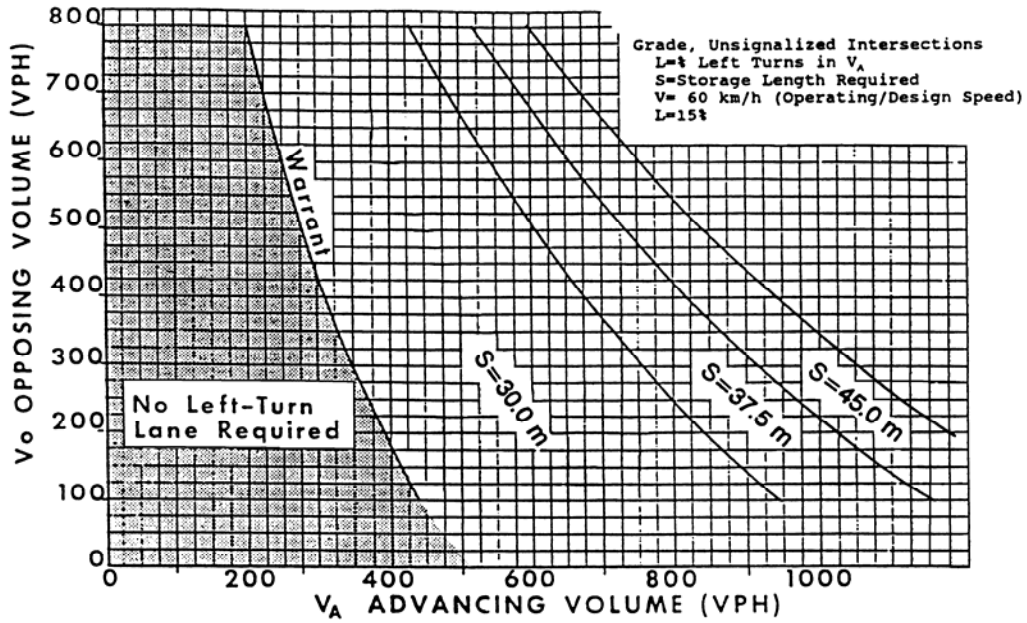

FIGURE C-1-1.4M

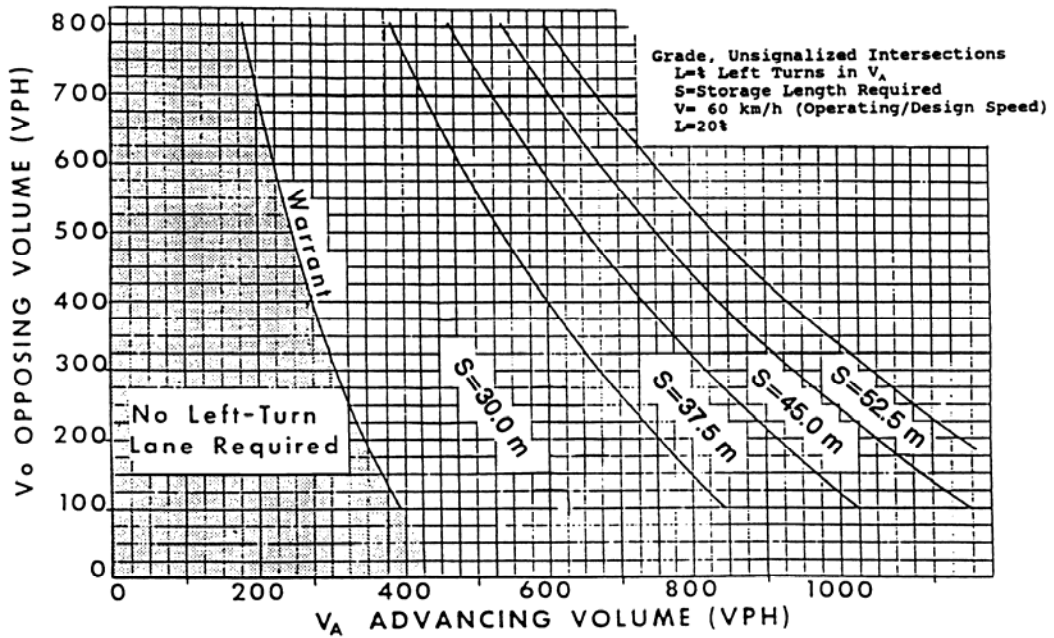

FIGURE C-1-1.5M

WARRANT FOR LEFT-TURN STORAGE LANES ON TWO-LANE HIGHWAYS

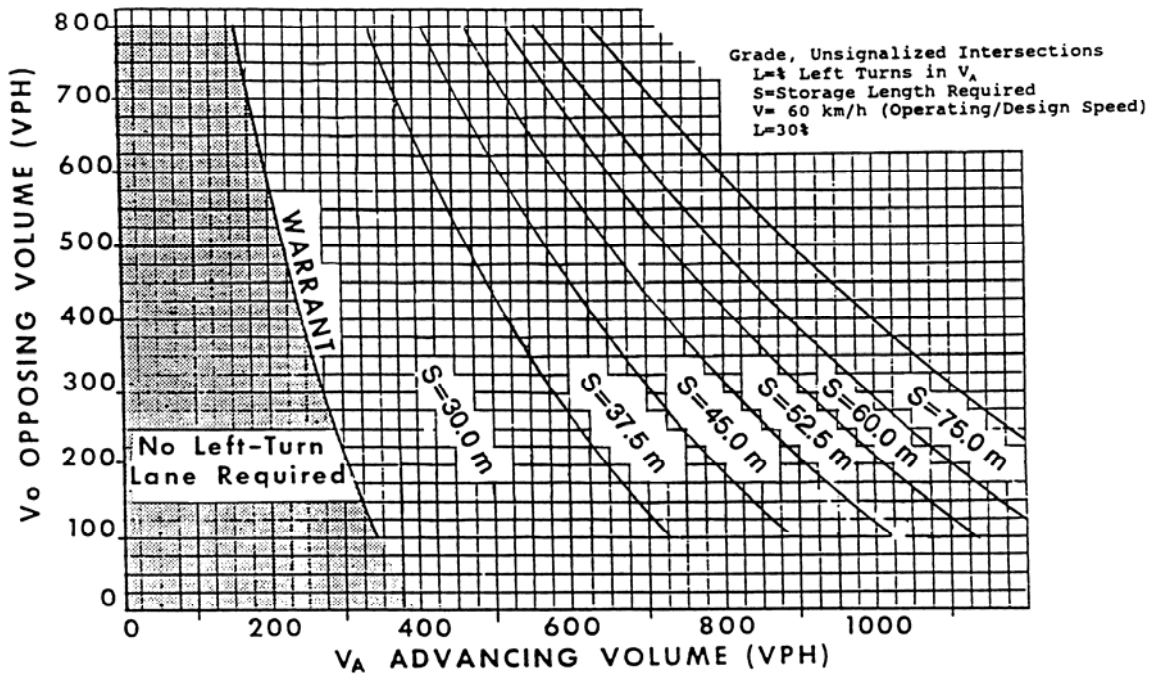

FIGURE C-1-1.6M

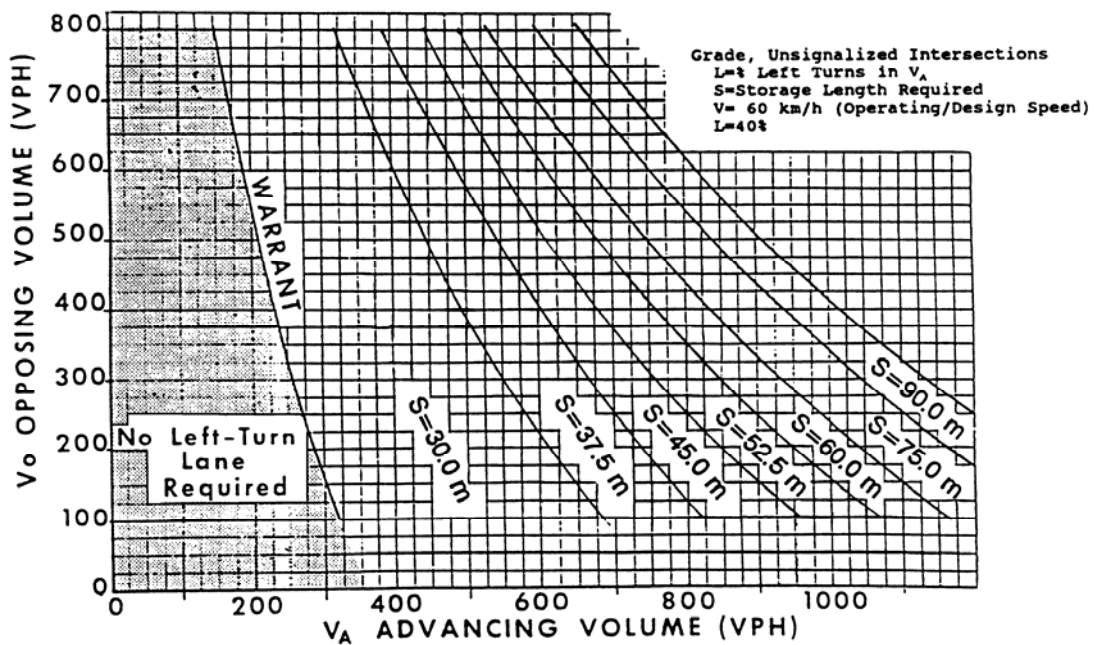

FIGURE C-1-1.7M

WARRANT FOR LEFT-TURN STORAGE LANES ON TWO-LANE HIGHWAYS

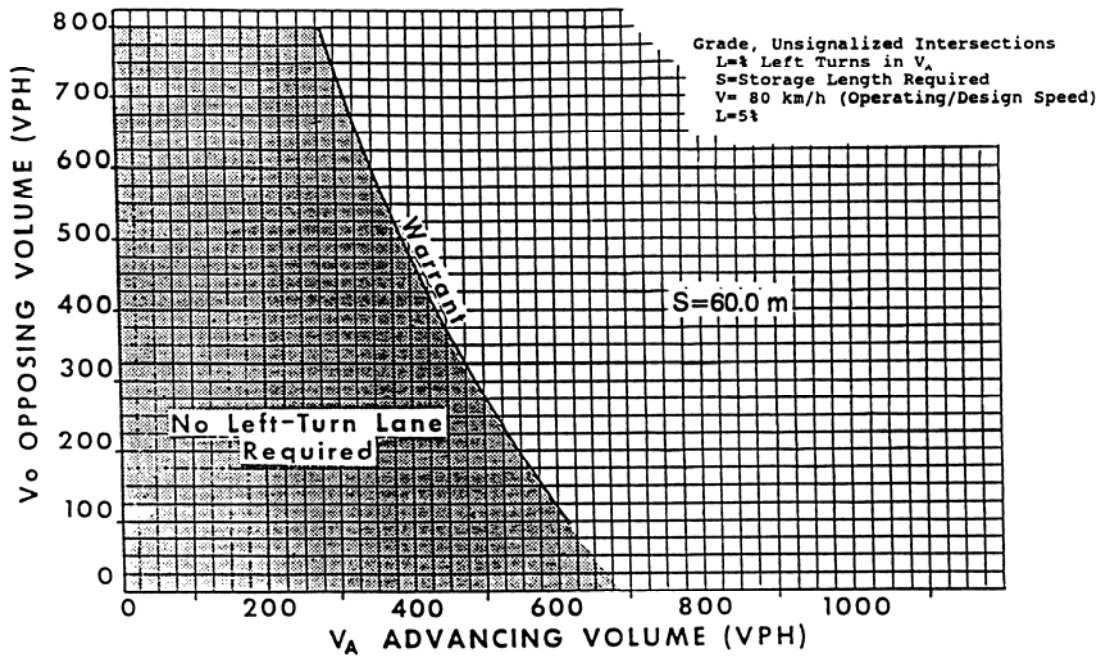

FIGURE C-1-1.8M

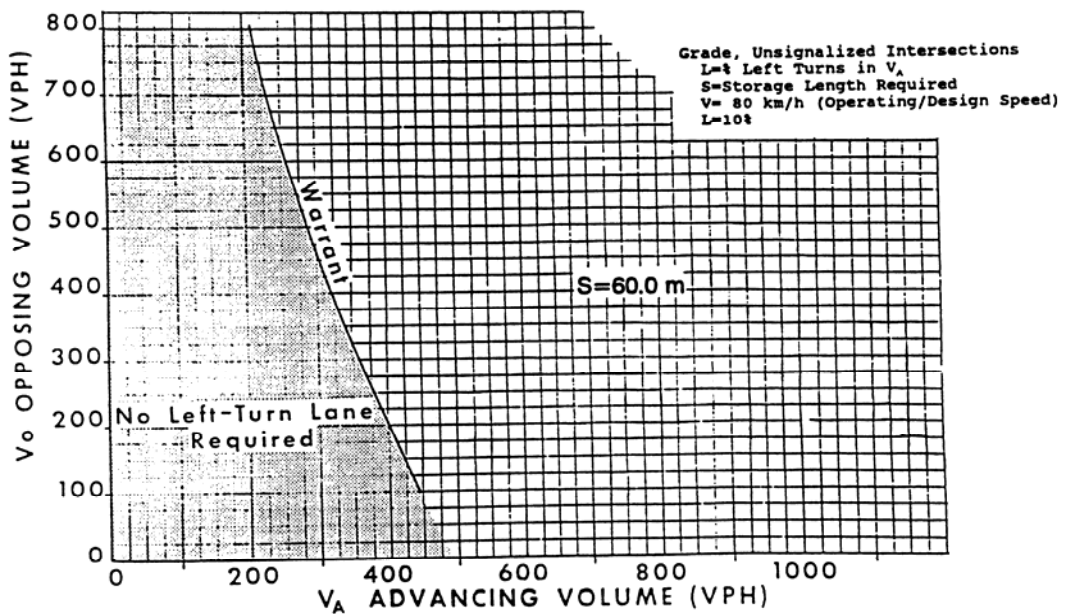

FIGURE C-1-1.9M

WARRANT FOR LEFT-TURN STORAGE LANES ON TWO-LANE HIGHWAYS

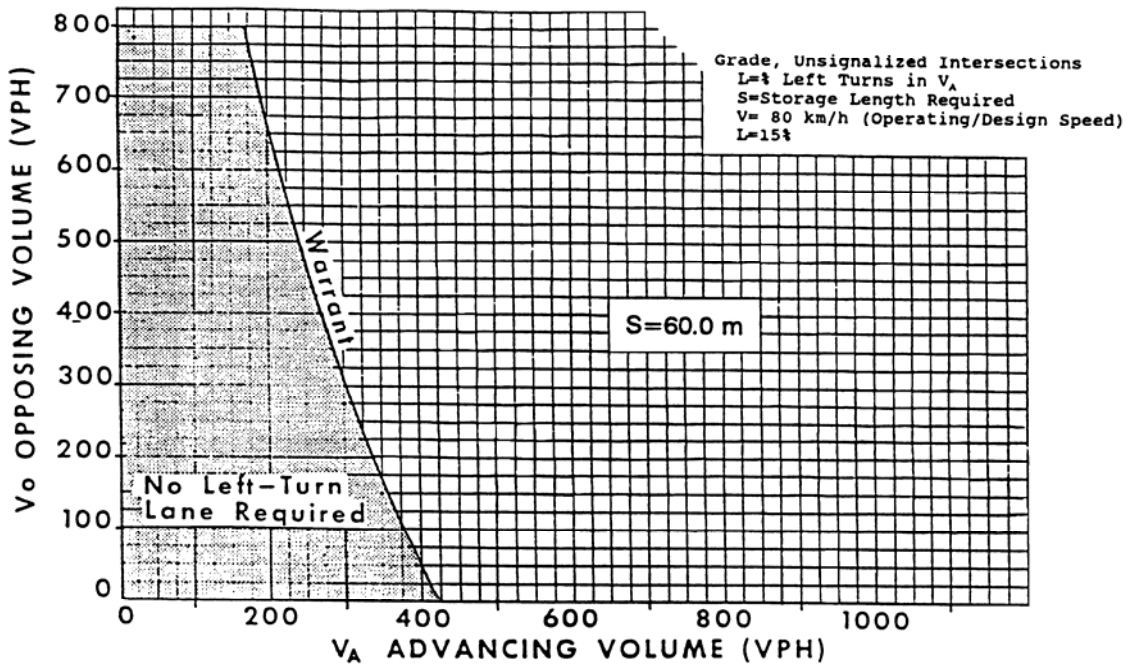

FIGURE C-1-1.10M

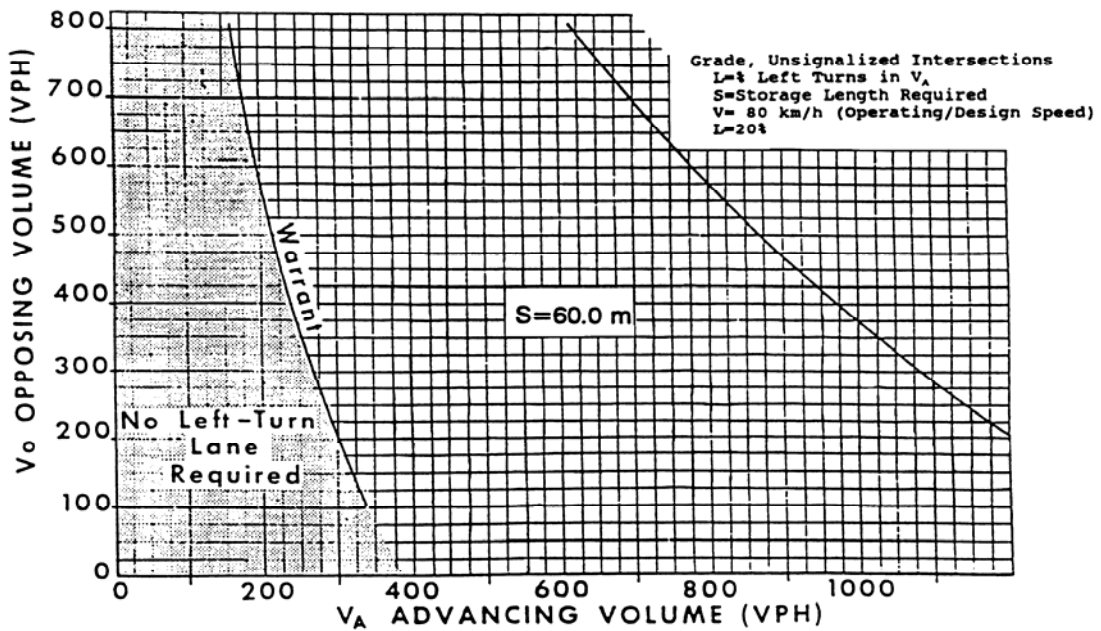

FIGURE C-1-1.11M

WARRANT FOR LEFT-TURN STORAGE LANES ON TWO-LANE HIGHWAYS

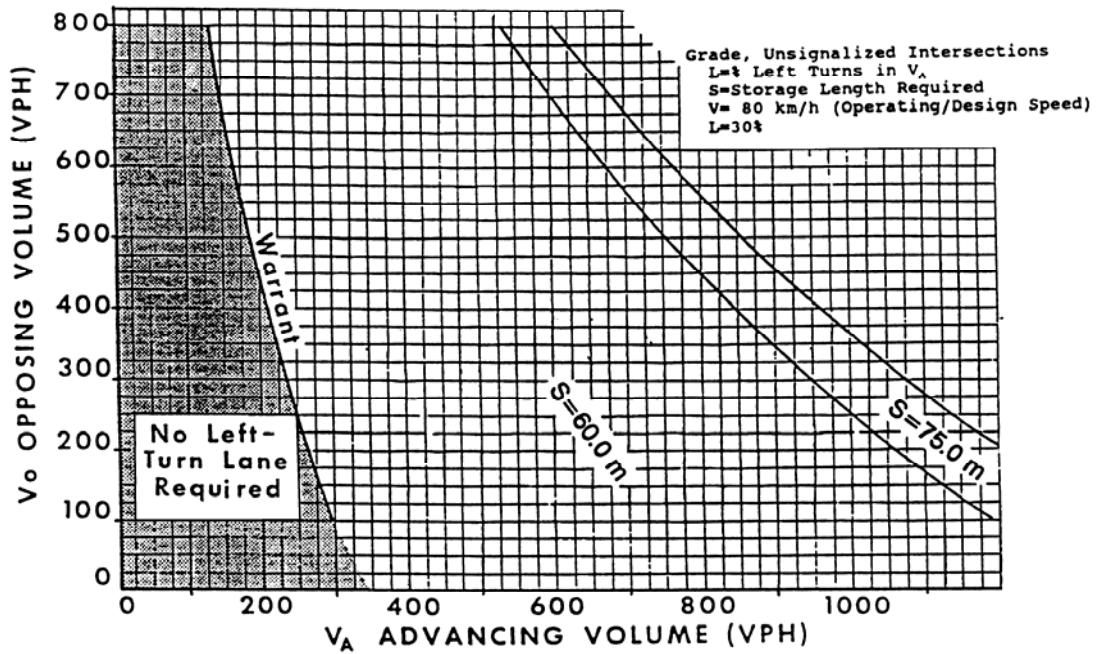

FIGURE C-1-1.12M

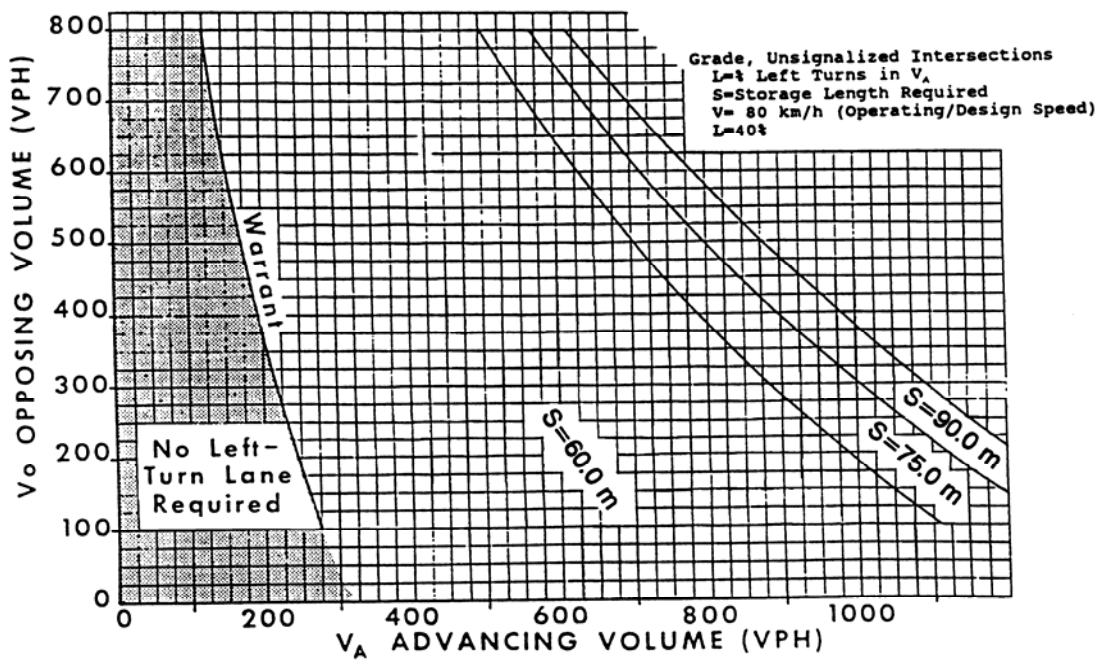

FIGURE C-1-1.13M

WARRANT FOR LEFT-TURN STORAGE LANES ON TWO-LANE HIGHWAYS

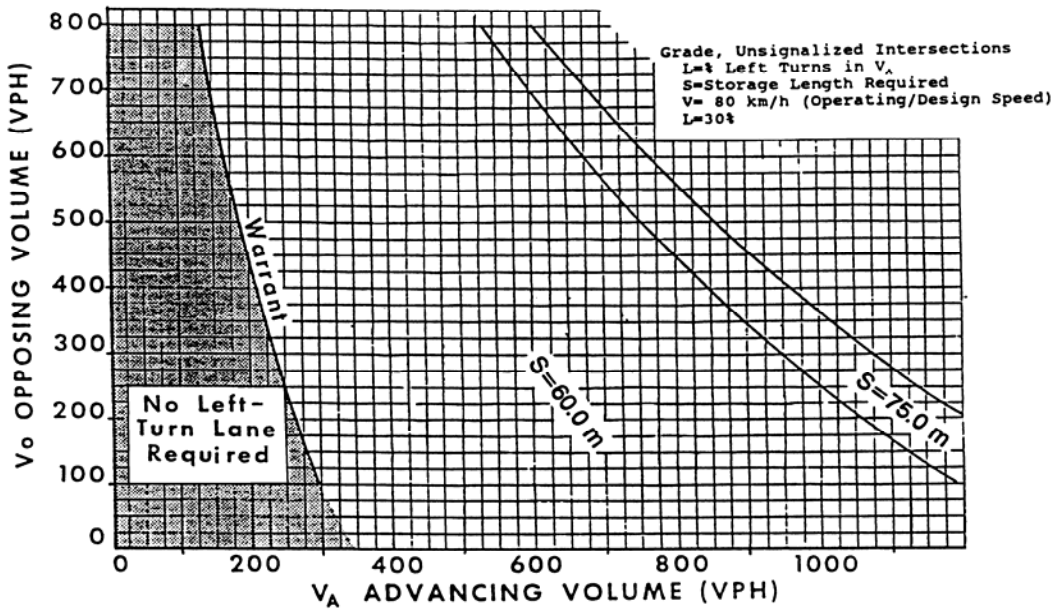

FIGURE C-1-1.14M

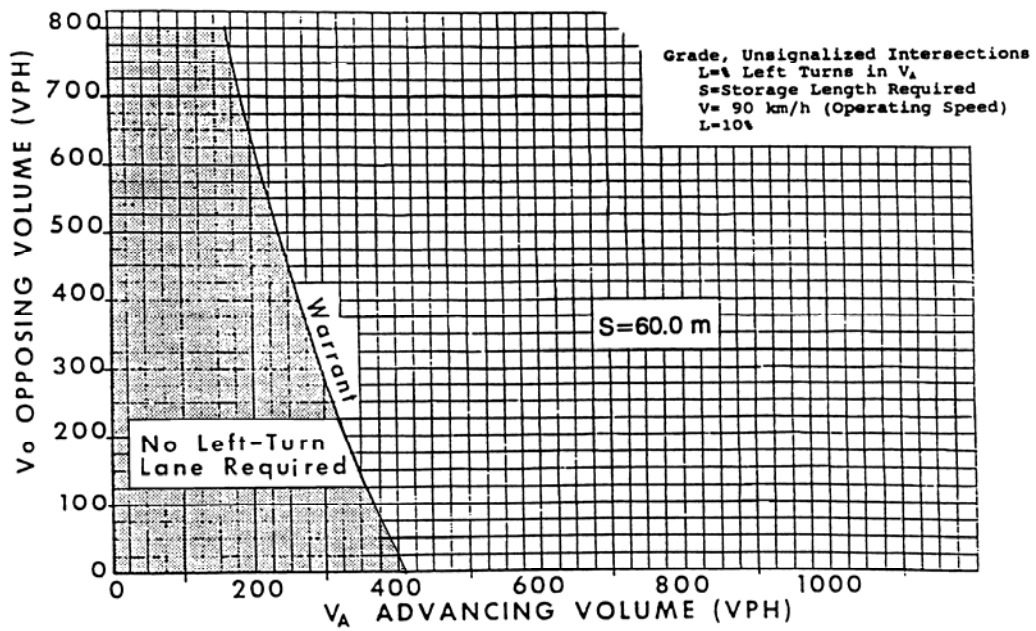

FIGURE C-1-1.15M

WARRANT FOR LEFT-TURN STORAGE LANES ON TWO-LANE HIGHWAYS

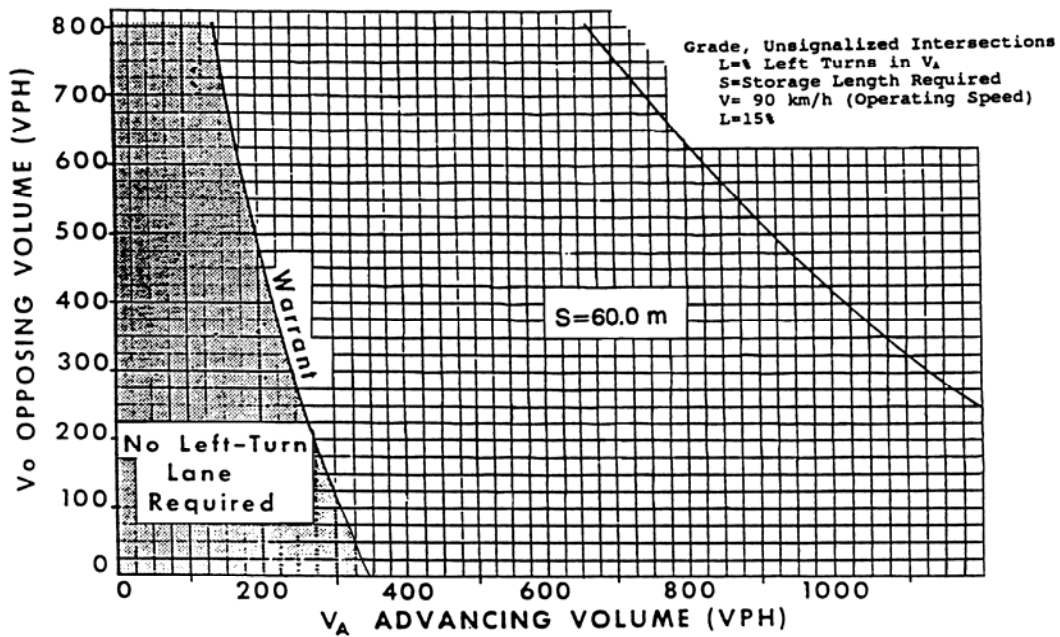

FIGURE C-1-1.16M

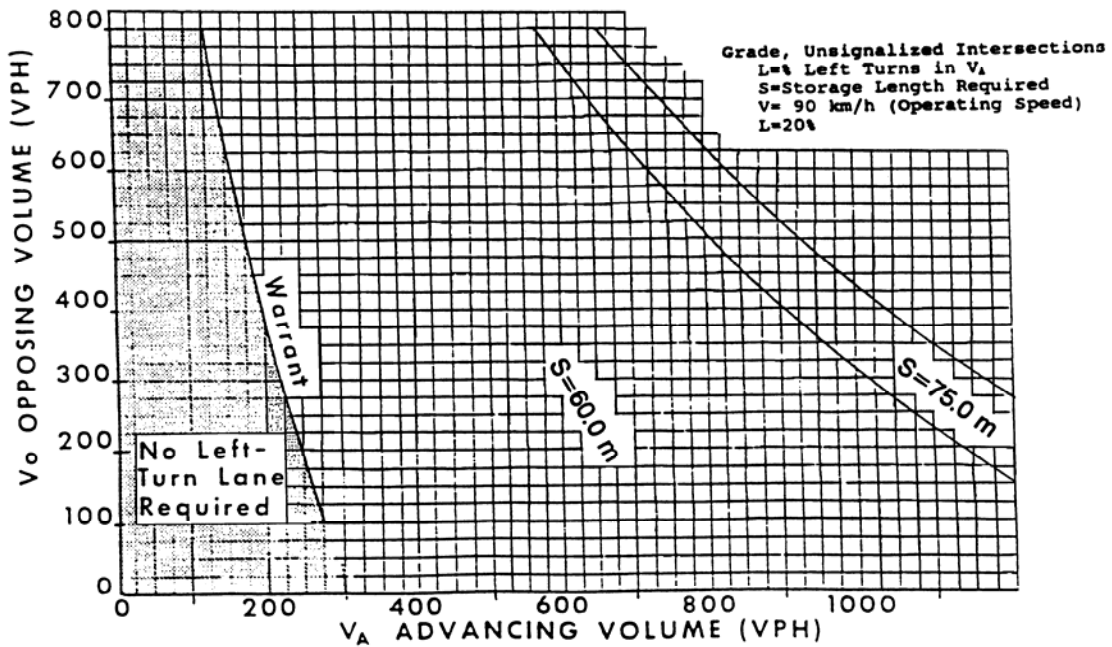

FIGURE C-1-1.17M

WARRANT FOR LEFT-TURN STORAGE LANES ON TWO-LANE HIGHWAYS

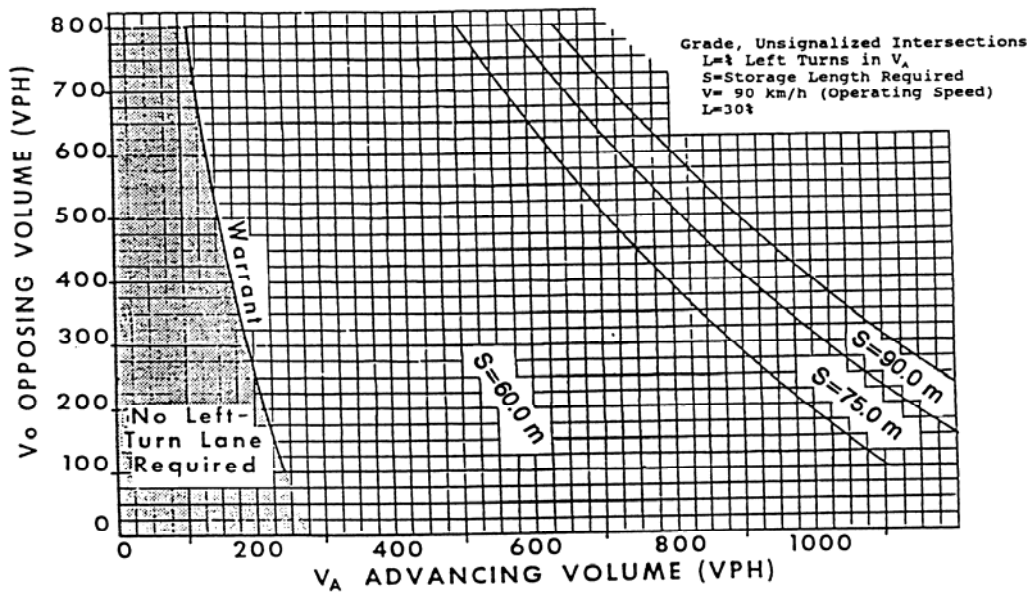

FIGURE C-1-1.18M

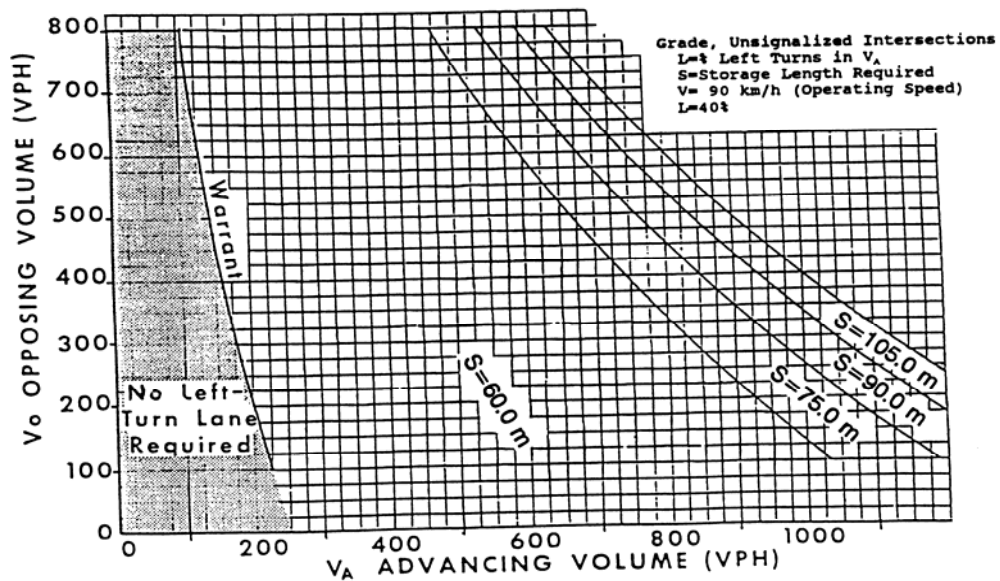

FIGURE C-1-1.19M

CHART VALUE OF STORAGE LANE REQUIRED	% TL = % TRUCKS IN VL					
	0%	10%	20%	30%	40%	50%
30.0 m	0.0 m	7.5 m	7.5 m	15.0 m	15.0 m	15.0 m
37.5 m	0.0 m	7.5 m	7.5 m	15.0 m	15.0 m	22.5 m
45.0 m	0.0 m	7.5 m	15.0 m	15.0 m	22.5 m	22.5 m
52.5 m	0.0 m	7.5 m	15.0 m	22.5 m	22.5 m	30.0 m
60.0 m	0.0 m	7.5 m	15.0 m	22.5 m	30.0 m	30.0 m
75.0 m	0.0 m	7.5 m	15.0 m	22.5 m	30.0 m	37.5 m
90.0 m	0.0 m	15.0 m	22.5 m	30.0 m	37.5 m	45.0 m
105.0 m	0.0 m	15.0 m	22.5 m	37.5 m	45.0 m	52.5 m
120.0 m	0.0 m	15.0 m	30.0 m	37.5 m	52.5 m	60.0 m
135.0 m	0.0 m	15.0 m	30.0 m	45.0 m	60.0 m	67.5 m
150.0 m	0.0 m	15.0 m	30.0 m	45.0 m	60.0 m	75.0 m

TABLE C-1-2.1M

TRUCK ADJUSTMENTS

**STORAGE LENGTH TO BE ADDED TO CHART VALUES OF LEFT-TURN LANE
STORAGE LENGTHS (Length in Meters)**

For additional information see Highway Research Report Number 211, Volume Warrants for the Left Turn Storage Lanes at Unsignalized Grade Intersections.*

* Rev. 1/06

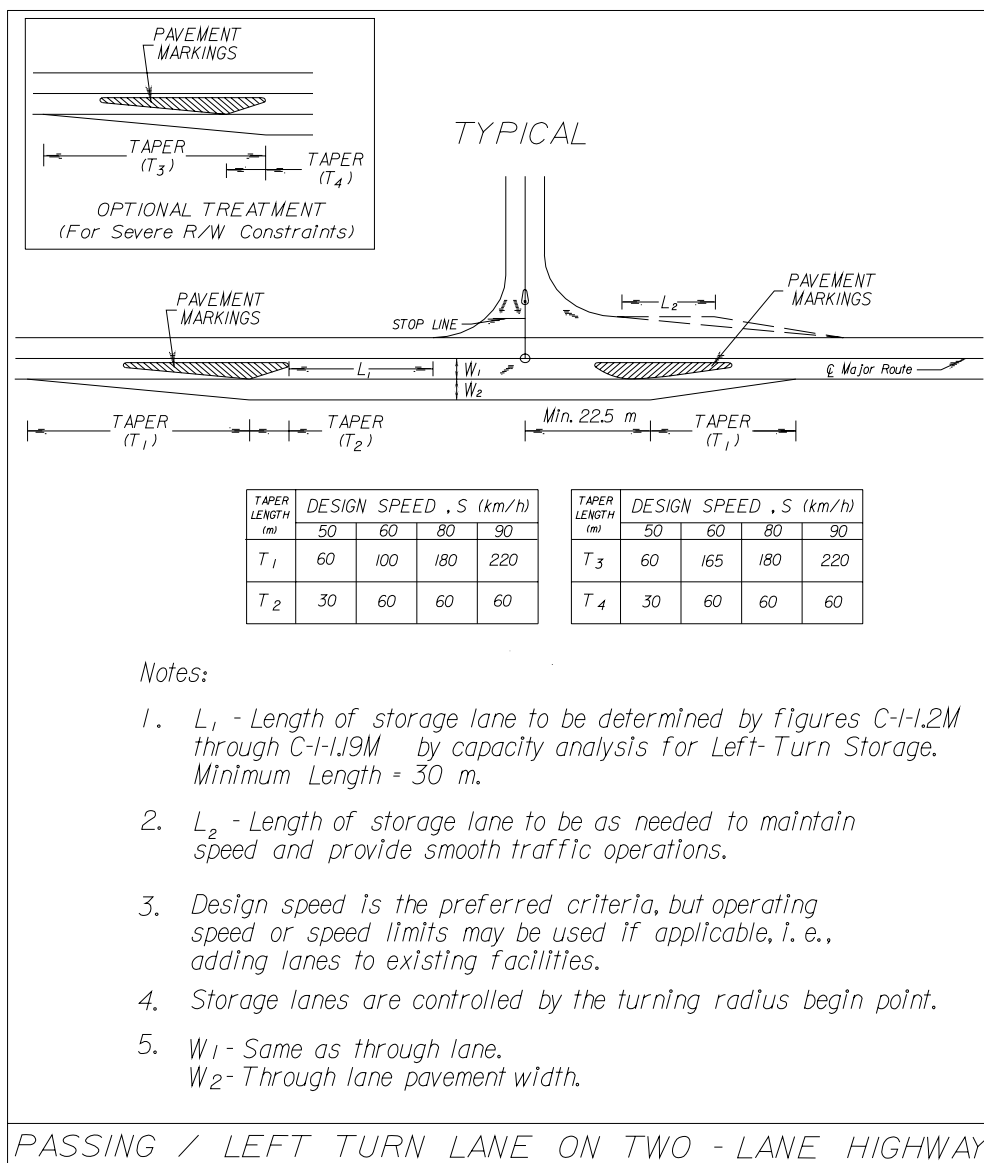

Source: 2003 MUTCD Chapter 6, Page 6C-8, Table 6C-4 (Formulas for Determining Taper Lengths). Found at the following: <http://www.virginiadot.org/business/bu-mutcd-disclaim.asp>*

FIGURE C-1-1.20M

* Rev. 7/06

DOUBLE (DUAL) LEFT-TURN LANES

Double (dual) left-turn lanes (DLTL's) shall be considered when left-turn demand exceeds 300 vph, and are desirable where peak left-turn movements exceed 350 vph. DLTL's require a protected (exclusive) signal phase, a 8.4 m minimum median width, and a width of a least 9 m on the acceptance lanes (see Figure C-1-2M). The length of storage should accommodate at least 1.5 times the expected vehicles making left turns per cycle based on peak 15-min. periods. When DLTL's are required, a capacity analysis of the intersection should be performed to determine what traffic controls are necessary (i.e. - signalization, separate phasing) in order to have this double left-turn lane function properly.

Continuous Left-Turn Lanes (Two way, used for left-turn lane in either direction)

Continuous two-way median left-turn lanes (C2WMLTL's) should be considered on low-speed arterial highways (40 to 70 km/h) with no heavy concentrations of left-turn traffic. C2WMLTL's also may be used where an arterial or major route must pass through a developed area having numerous street and driveway intersections, and where it is impractical to limit left turns. The minimum desirable width shall be 3.6 meters (4.8 m maximum).

C2WMLTL's shall only be used with roadways having a maximum of 2 through lanes in each direction, and shall be shown in accordance with Figure C-1-2.1M.

In commercial and industrial areas where property values are high and rights of way for wide medians are difficult to acquire, a paved flush traversable median 3.05 m to 4.88 m wide is the optimum design. Successful operation of a continuous left-turn lane requires adequate lane marking.

Advantages are:

- Reduced travel time.
- Improved capacity.
- Flexibility of using as temporary detour during closure of through lane.
- Does not control or limit the number of left turns.
- Minimizes interference to through traffic lanes.
- Separates opposing traffic flows by one full lane.
- Public preference (both from drivers and owners of abutting properties.)
- Reduced accident frequency, particularly rear-end collisions.

Disadvantages:

- Poor visibility (corrected by using proper delineation).

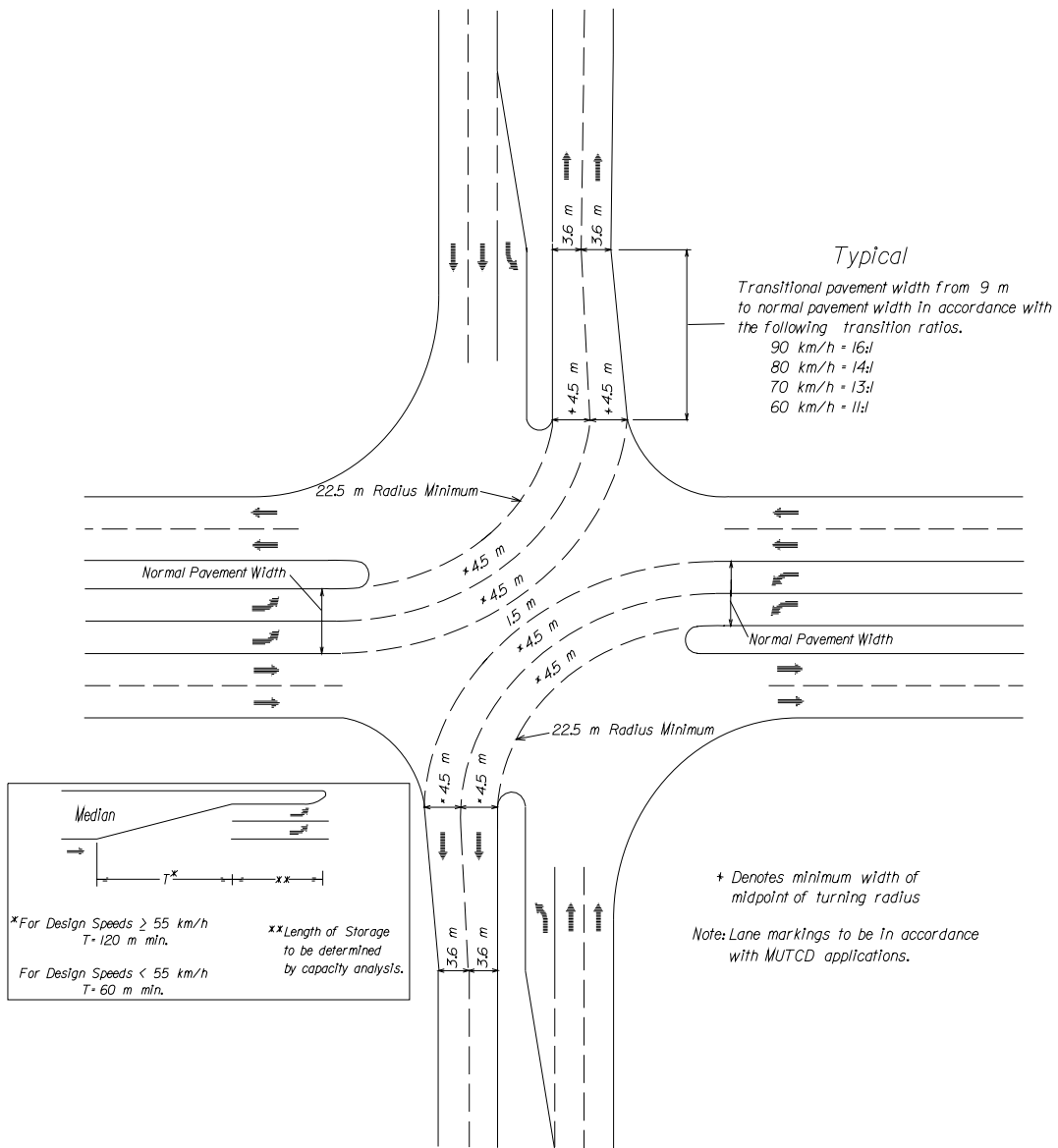

DOUBLE LEFT-TURN LANES

FIGURE C-1-2M

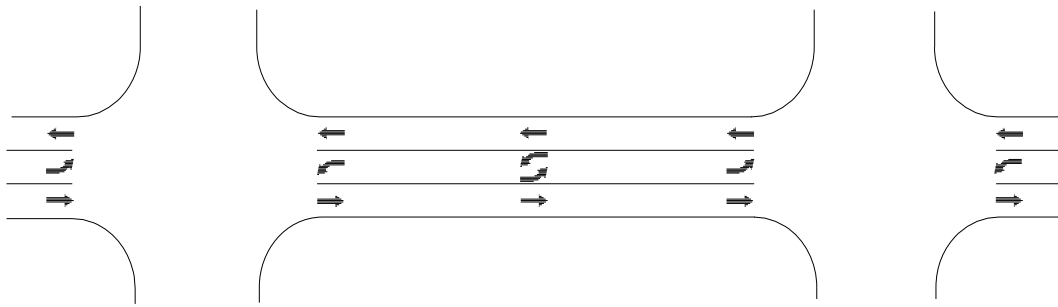

Typical 3-Lane Configuration
W/Left Turn Provisions for the Minor Street

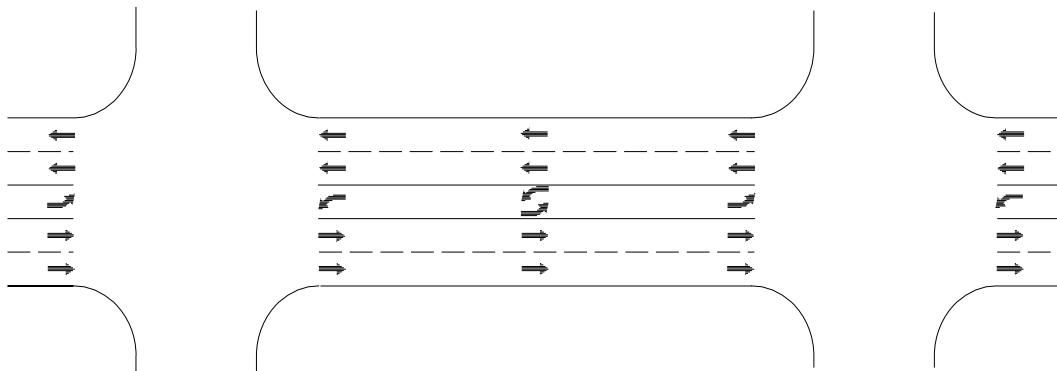

Typical 5-Lane Configuration
W/Left Turn Provisions for the Minor Street

CONTINUOUS TWO-WAY MEDIAN LEFT-TURN LANES

(Lane markings to be in accordance with MUTCD application)

FIGURE C-1-2.1M

CROSSOVERS WITHOUT AND WITH CONNECTIONS

Median openings should be designed with a minimum length of 12 m. The shape of the median end should generally be symmetrical when the median width is less than 3 m and the median opening length is not excessive, but the bullet nose can be effectively used to reduce the opening. For a median width of 3 m or more, the bullet nose design should be used instead of a semicircular design. At 3-leg and 4-leg intersections, the length of the crossover and the shape of the median end is controlled by the width of the median and the turning radii. (See Figure C-1-3M). A wide median opening can be reduced at skewed intersections by utilizing modifications of the bullet nose design. Additional information may be obtained from AASHTO's A Policy on Geometric Design of Highways and Streets (Median Openings).

INTERSECTION DESIGN

Signalized and Unsignalized

At-grade intersections must provide adequately for anticipated turning and crossing movements. Figures C-1-4M and C-1-5M provide the designer with the basic types of intersection designs and recommendations pertinent to dimensions, radii, skews, angles, and the types of island separations, etc., to be considered. AASHTO's A Policy on Geometric Design of Highways and Streets, Chapter 9* (Intersections) should be reviewed for additional information to be considered in the design since the site conditions, alignment and grades, sight distance, the need for turning lanes and other factors enter into the type of intersection design which would satisfy the design hour volume of traffic, the character or composition of traffic, and the design speed.

Sufficient offset dimensions, pavement widths, pluses, and radii shall be shown in the plans by the designer to insure that the sign island is properly positioned.

Care should be taken in the design of four-lane roadways with intersecting two-lane roadways. If traffic conditions clearly warrant a four-lane divided design for the two-lane road at the intersection, the divided design must be constructed for a sufficient distance to allow for the approaching divided design and the subsequent stop condition ahead to be properly signed. The four-lane divided design should not be constructed unless it is clearly warranted and the approaches can be properly signed or the minor road is expected to be improved to a divided status in the near future.

* Rev. 7/07

ROUNABOUTS*

Operational and safety characteristics of roundabouts should be compared with those of signalized and unsignalized intersections on all projects and be used if deemed appropriate. Roundabout designs should be based on Federal Highway Administration Publication Number FHWA-RD-00-067, Roundabouts: An Informational Guide at <http://www.tfhrc.gov/safety/00068.pdf>. Additional information can also be found in VDOT's Roundabout Brochure at <http://www.virginiadot.org/infoservice/faq-roundabouts.asp>. See Figure C-1-2.2 for Roundabout Details. When roundabout design is proposed, the Residency Administrator should consult the District Location & Design Engineer.

THE APPROVAL PROCESS FOR ROUNABOUTS IS AS FOLLOWS:

Existing and Proposed Subdivisions- The District may review and approve.

Secondary System- District may approve up to a traffic design volume of 10,000 VPD. Roundabout designs in which the counts are beyond this volume should be submitted to the Central Office Roundabout Review Committee for review. The committee will make recommendations to the State Location and Design Engineer for approval or disapproval. Appeals of the State Location and Design Engineer decision will go to the Chief Engineer for resolution. (When a District receives a request for a roundabout from an outside entity, and the design volume is under 10,000 VPD but desires Roundabout Committee review and input. The submittal may be sent to the State Location and Design Engineer. It will be reviewed and comments and/or recommendations will be returned in a timely manner.)

Primary or Urban System- The District will submit roundabout designs to the Central Office Roundabout Committee for review. The approval and appeals will be the same as used above for these roadway systems with one exception, urban systems will require approval of the Local Assistance Division Administrator as well as the State Location and Design Engineer.

The process listed above applies to:

- Roundabouts proposed through 6 year construction program.
- Roundabouts proposed during road safety improvements and/or upgrades.
- Roundabouts proposed by Counties, Localities, Consultants and Developers.

The submittal should contain and depict the following criteria:

- Approach Grades and sight distances.
- Inscribed diameter of circulatory roadway.
- Design vehicle (WB-50 or WB-67).
- Apron width, circulatory lane width and approach lane widths.
- Approach lane deflection and length of splitter islands.
- Pedestrian crossing locations.
- Pavement markings.
- Signing.

* Rev. 7/06

- Roadway Lighting (desirable).
- Nearest entrance locations and nature of property use.
- Initial or present and projected design year traffic count on all approaches.
- Turning movements for all directions.
- SIDRA Analysis on all approaches showing peak hour LOS in design year.
- Autoturn results showing off tracking of Design Vehicle.
- Is this facility designed as a bicycle Route?
- Are their accommodations made to bicyclists?

If, for some reason, the District does not have capability to run the subject computer programs, the Roundabout Committee can provide assistance upon request.*

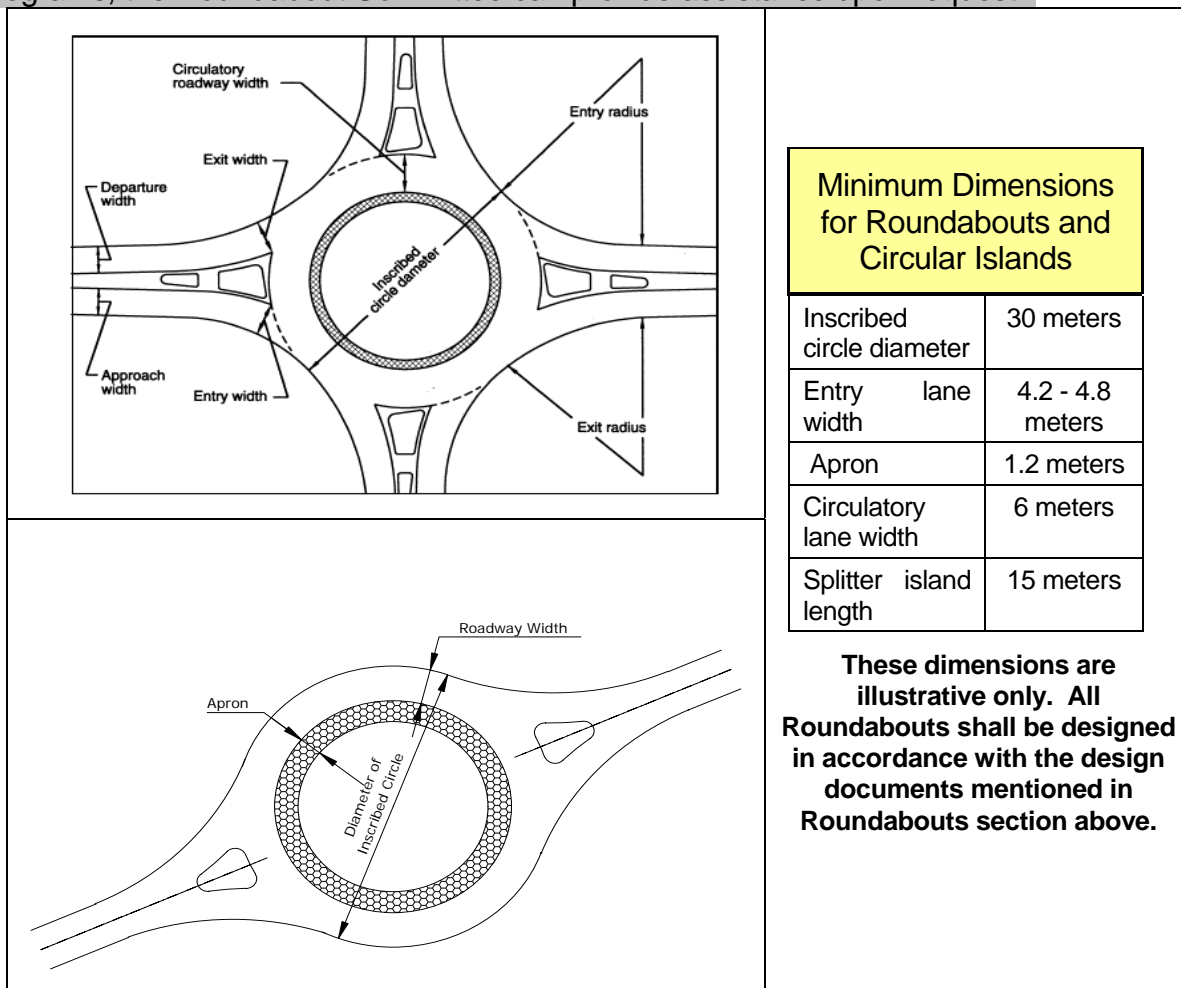

FIGURE C-1-2.2M ROUNDABOUT DETAILS

* Rev. 7/06

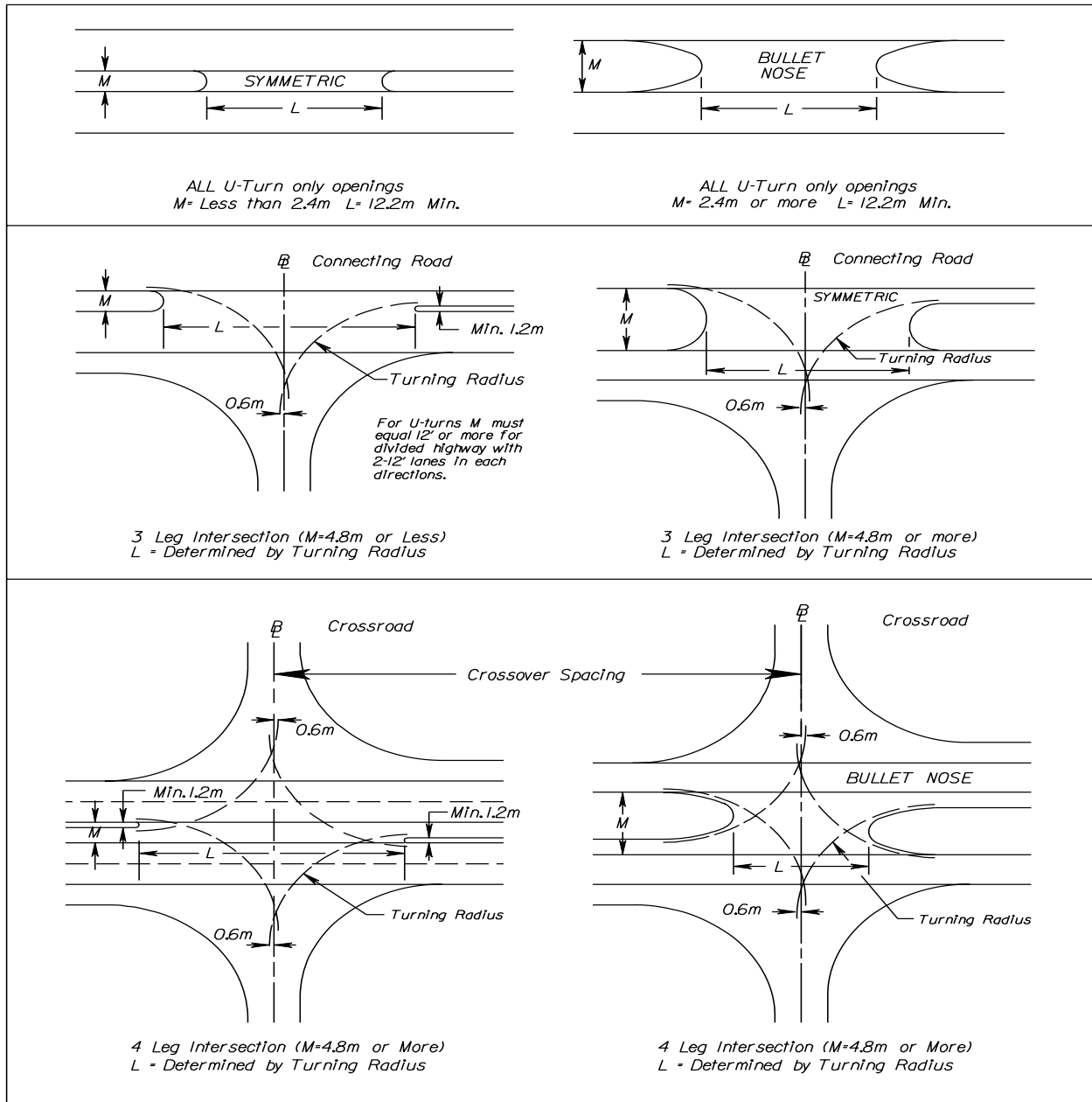

FIGURE C-1-3M CROSSOVERS WITHOUT AND WITH CONNECTIONS*

* Rev. 7/07

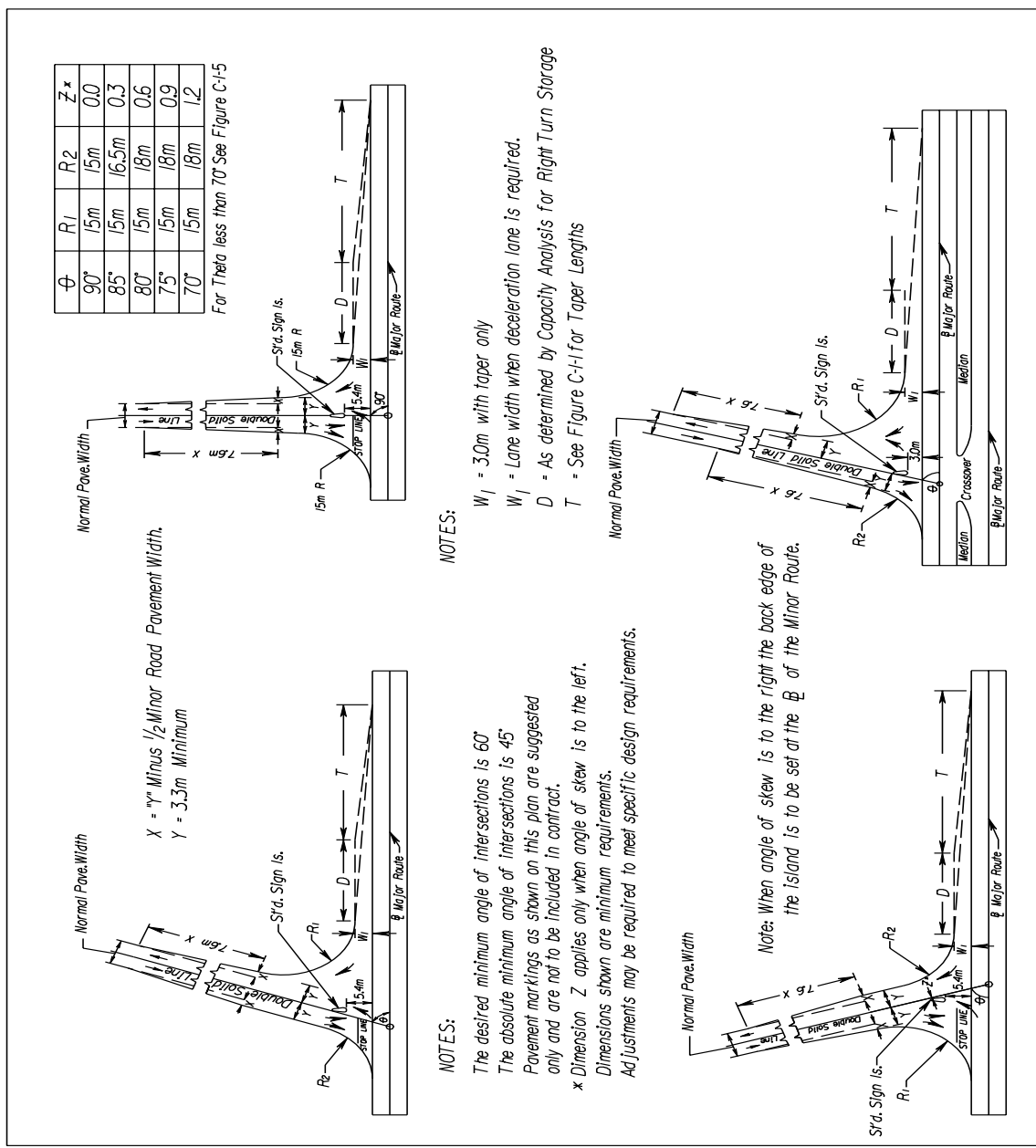

FIGURE C-1-4M

INTERSECTION DESIGN*

* Rev. 7/07

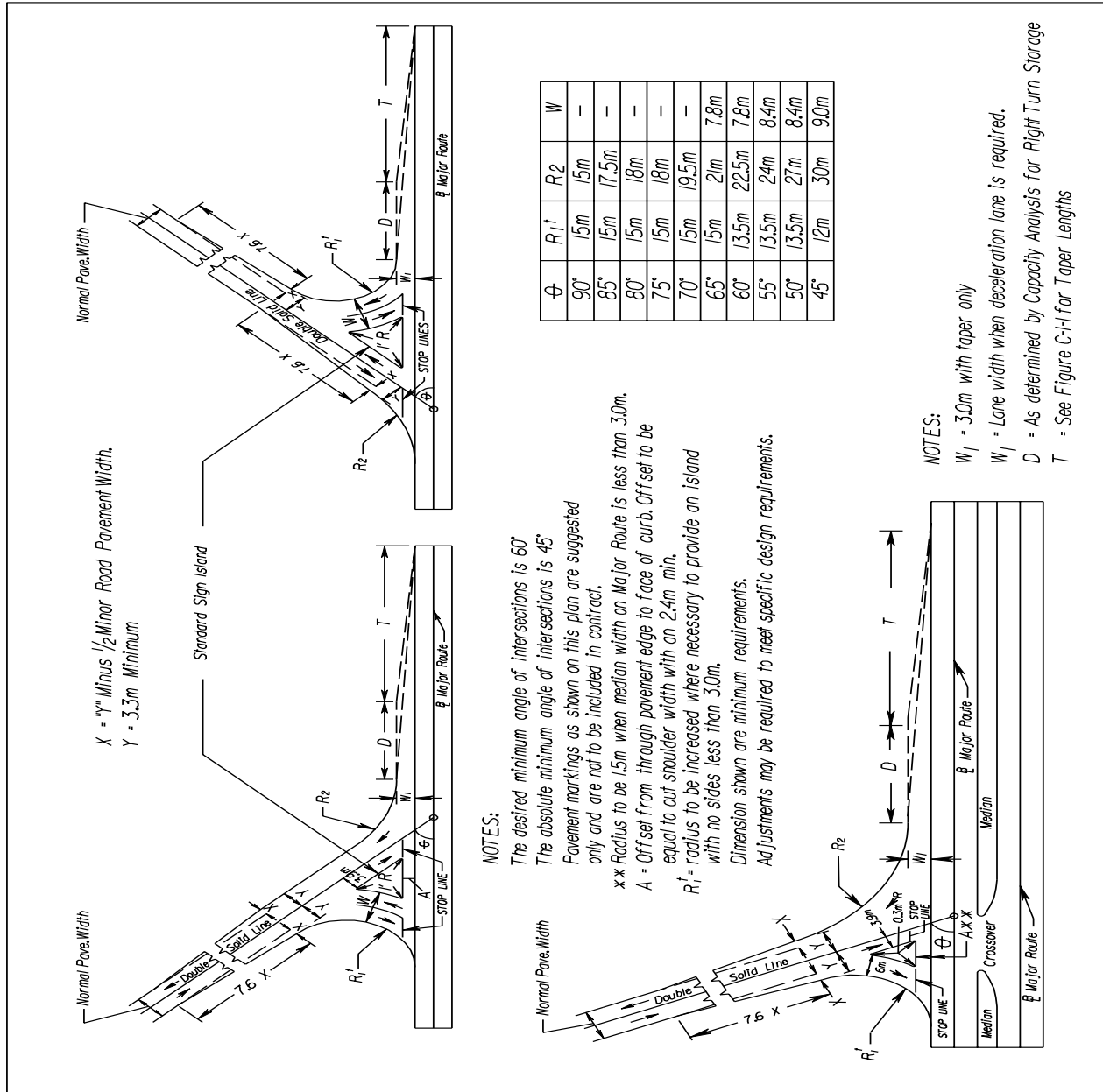
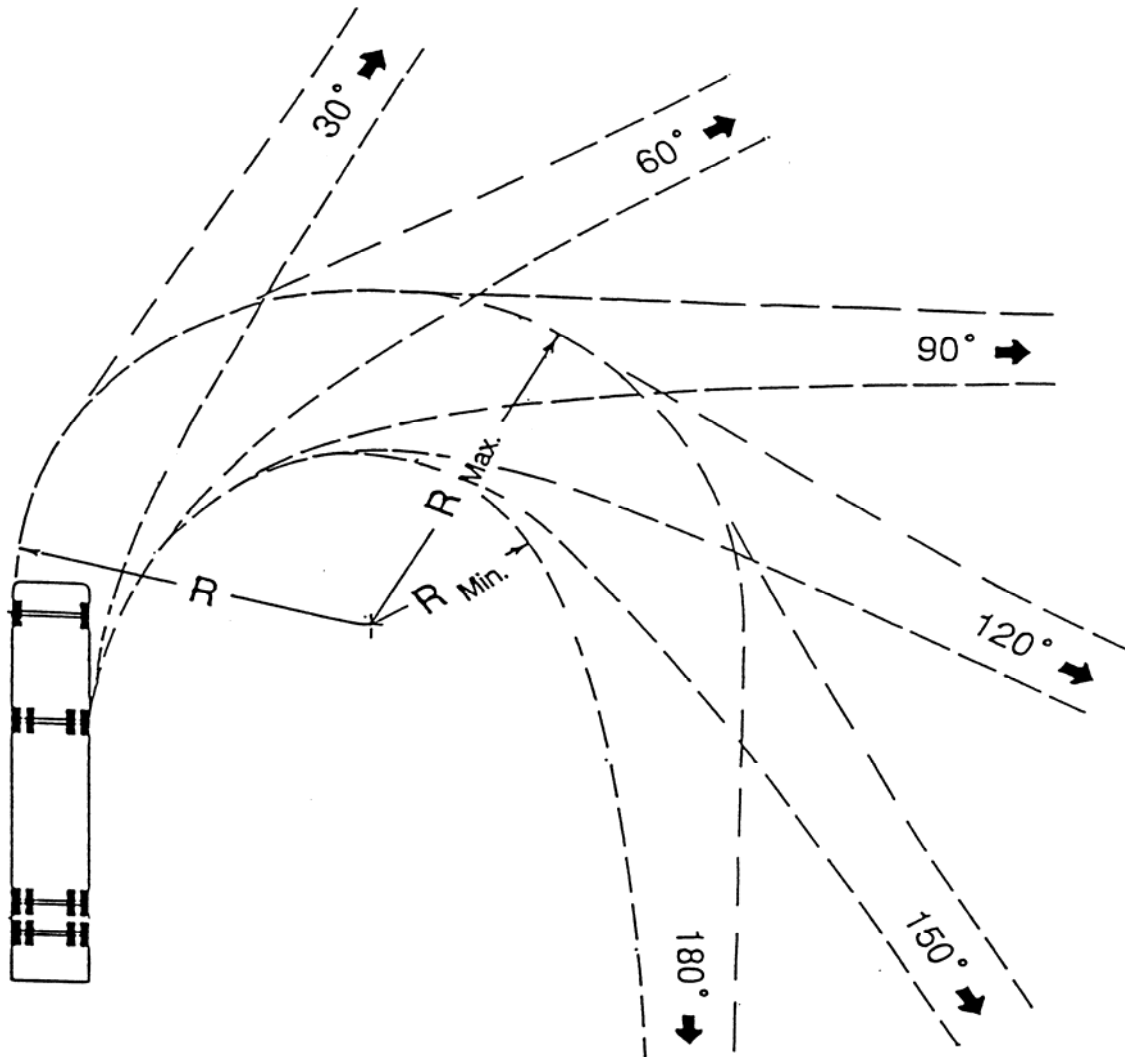

FIGURE C-1-5M

INTERSECTION DESIGN*

* Rev. 7/07



Minimum Turning Radius

$R = 12.2$ m Left Front Wheel (path not shown)

$R_{\text{Min.}} = 5.8$ m Right Rear Wheel

$R_{\text{Max.}} = 12.6$ m Left Front Overhang

WB-12(^{OLD}WB-40)

FIGURE C-1-5.1M

(NOT TO SCALE)

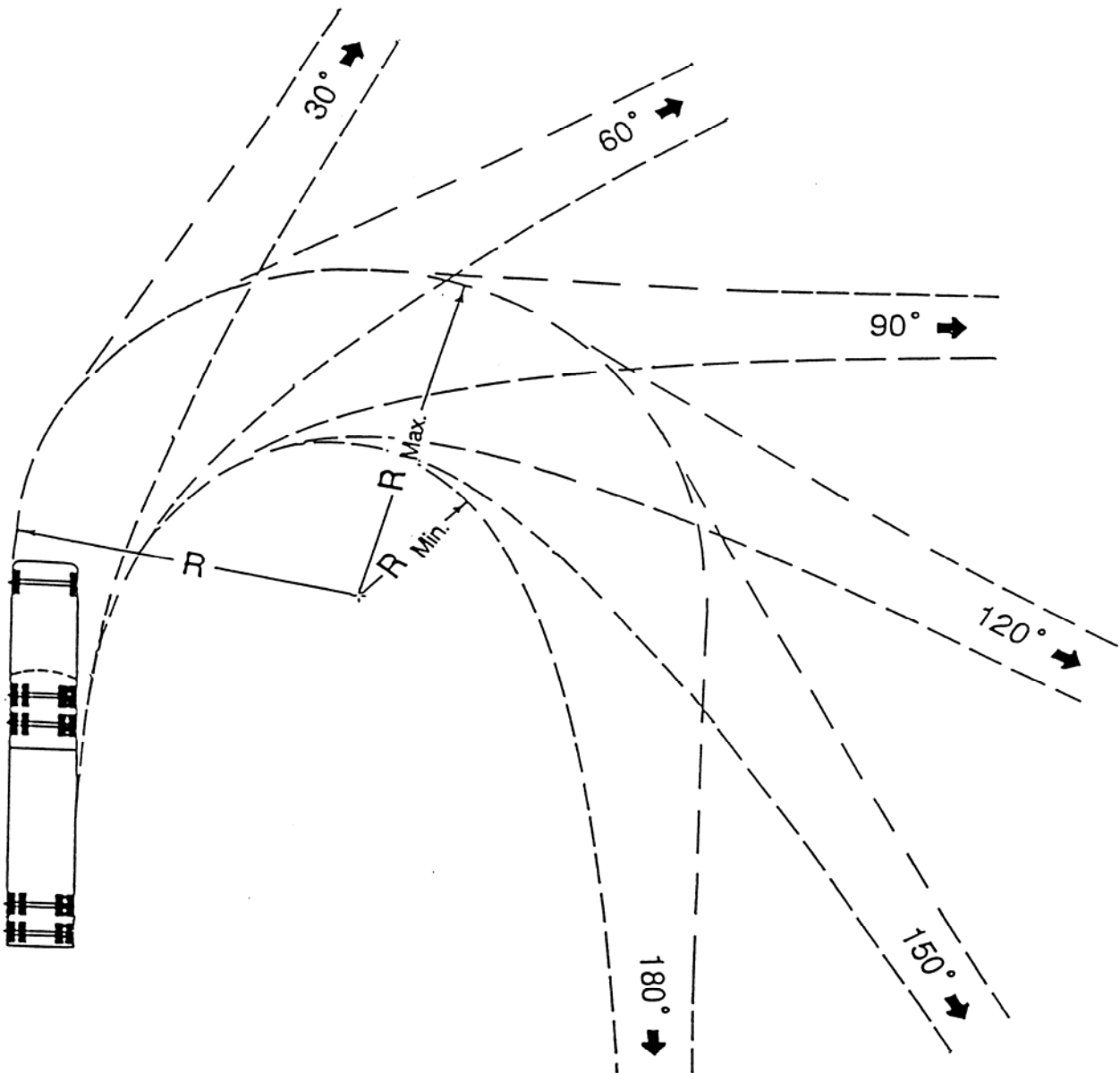

Minimum Turning Radius

$R = 13.7$ m Left Front Wheel (path not shown)

$R_{Min.} = 5.9$ m Right Rear Wheel

$R_{Max.} = 14.1$ m Left Front Overhang

WB-15^(OLD)
(WB-50)

FIGURE C-1-5.2M

(NOT TO SCALE)

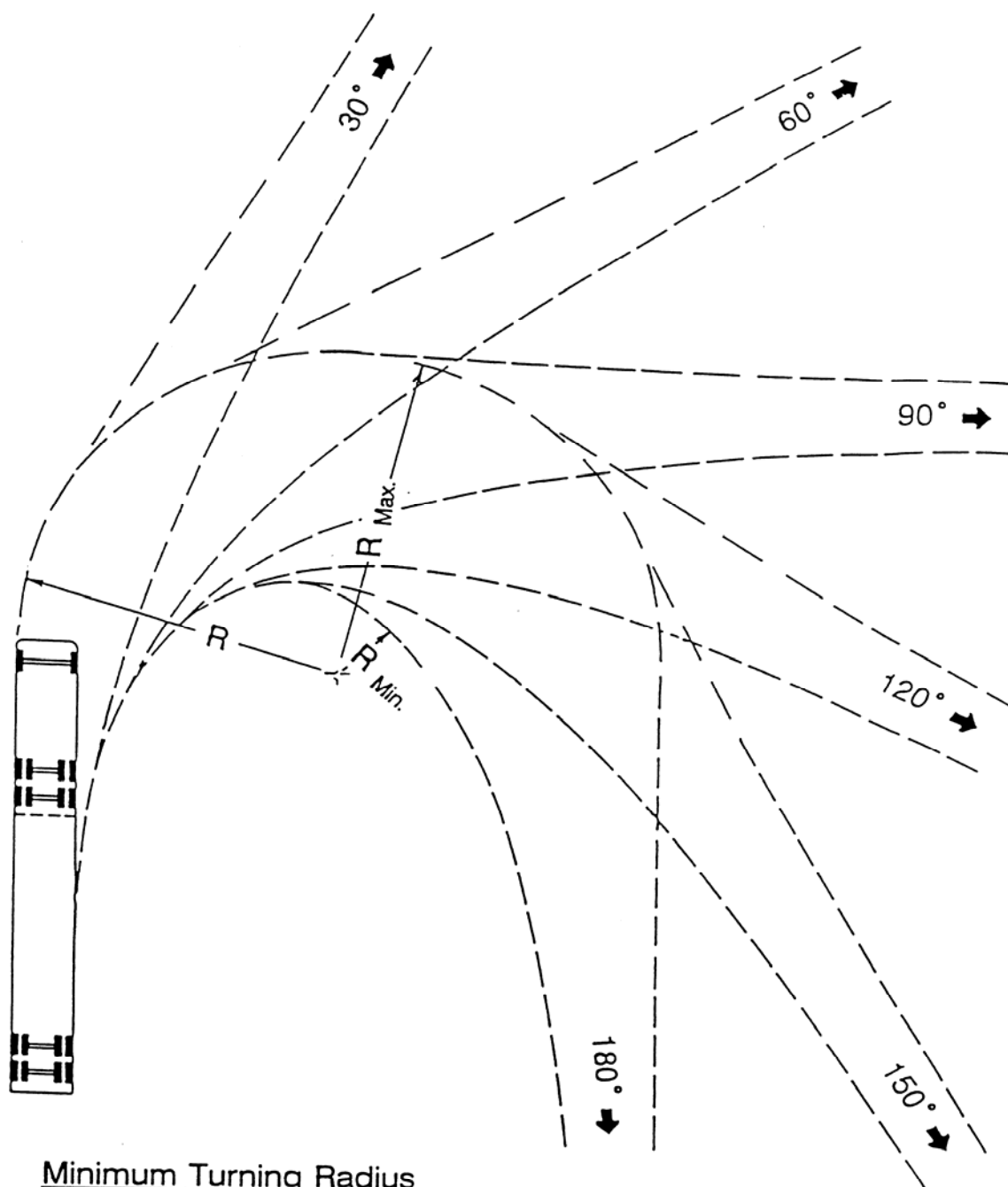

Minimum Turning Radius

$R = 13.7$ m Left Front Wheel (path not shown)

$R_{Min.} = 2.9$ m Right Rear Wheel

$R_{Max.} = 14.0$ m Left Front Overhang

WB-19^(OLD)
WB-62)

FIGURE C-1-5.3M

(NOT TO SCALE)

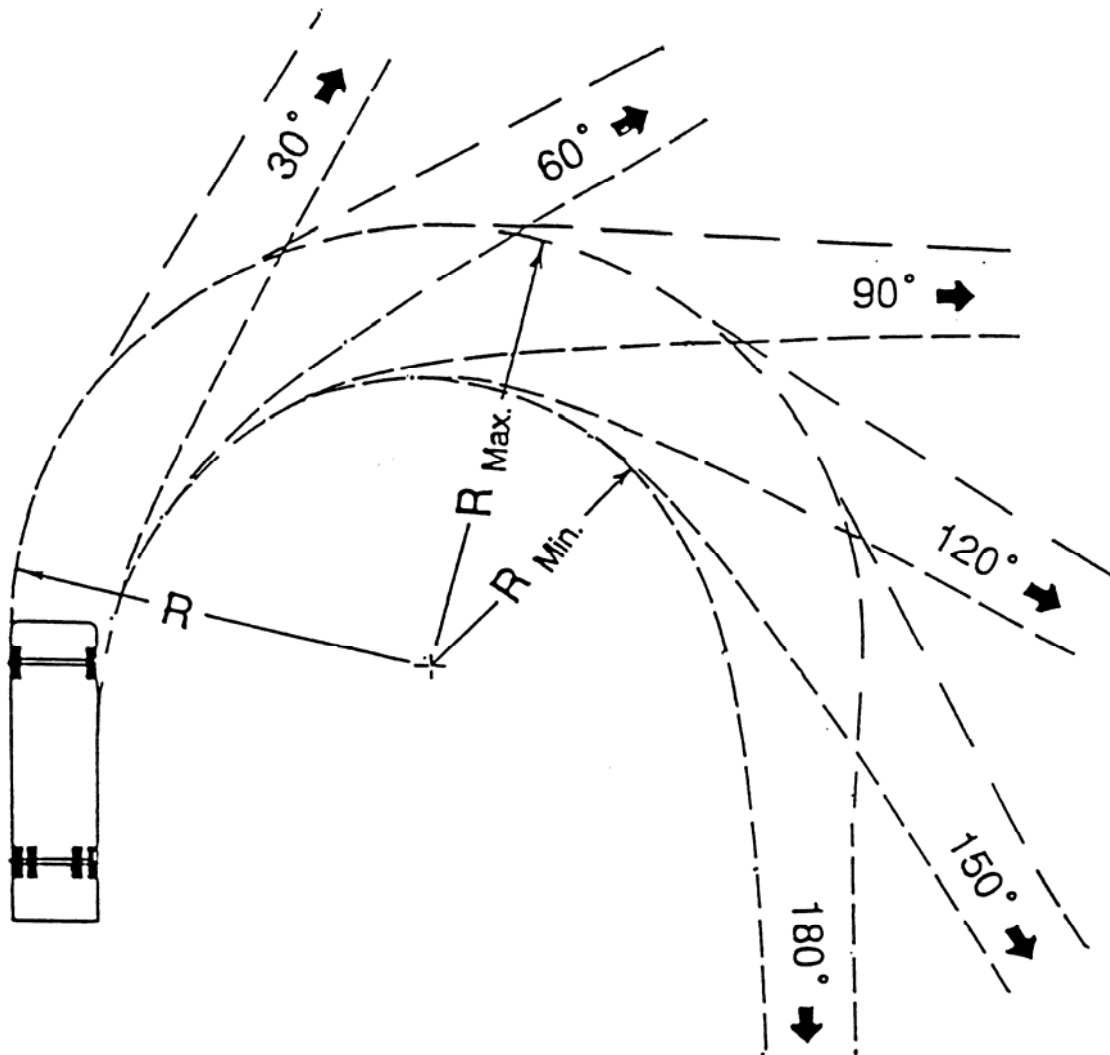

Minimum Turning Radius

$R = 12.8$ m Left Front Wheel (path not shown)

$R_{\text{Min.}} = 8.5$ m Right Rear Wheel

$R_{\text{Max.}} = 13.4$ m Left Front Overhang

SU

FIGURE C-1-5.4M

(NOT TO SCALE)

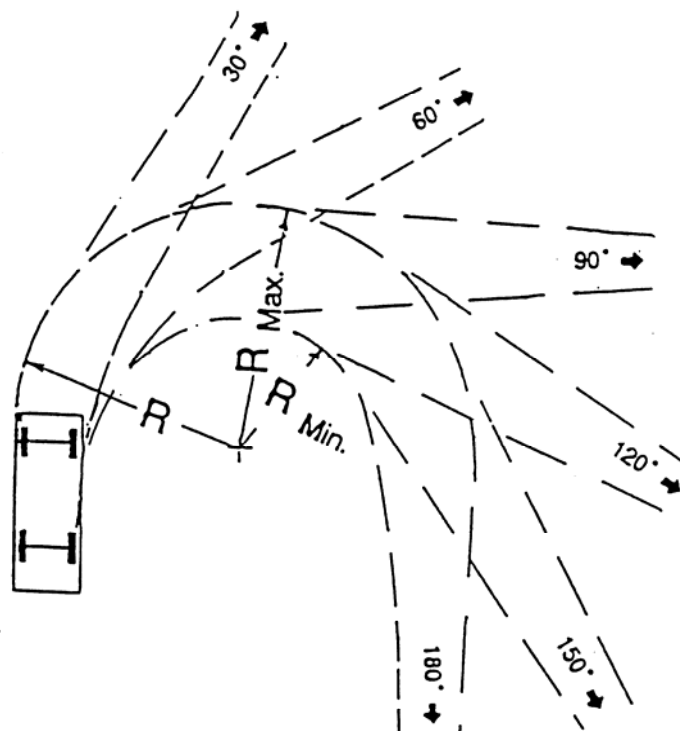

Minimum Turning Radius

$R = 7.3$ m Left Front Wheel (path not shown)

$R_{\text{Min.}} = 4.2$ m Right Rear Wheel

$R_{\text{Max.}} = 7.8$ m Left Front Overhang

P

FIGURE C-1-5.5M

(NOT TO SCALE)

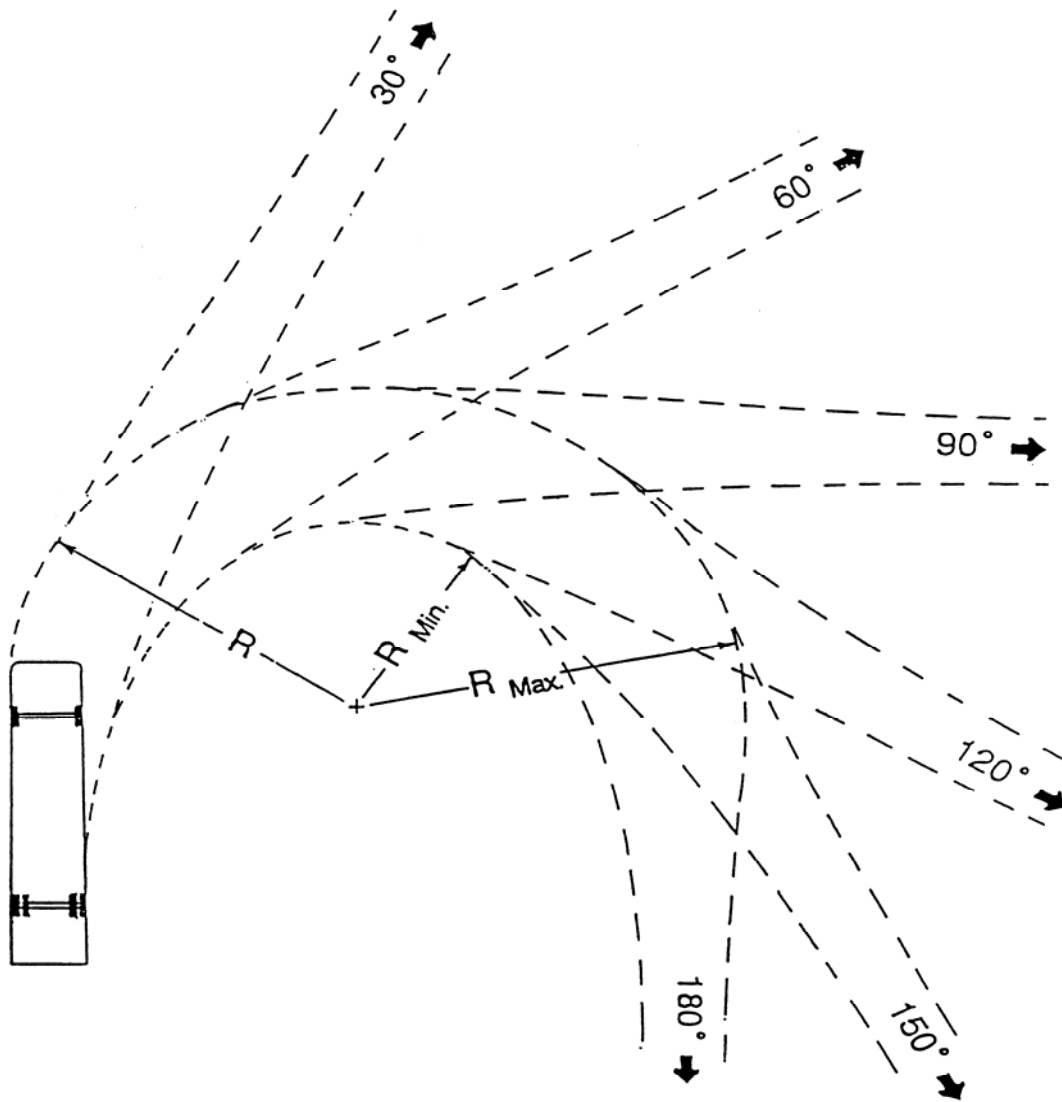

Minimum Turning Radius

$R = 12.8$ m Left Front Wheel (path not shown)

$R_{\text{Min.}} = 7.4$ m Right Rear Wheel

$R_{\text{Max.}} = 14.1$ m Left Front Overhang

BUS

FIGURE C-1-5.6M

(NOT TO SCALE)

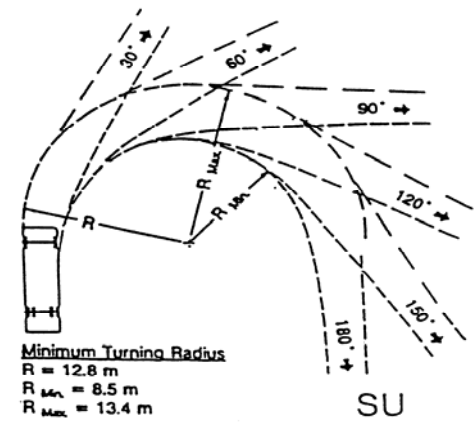
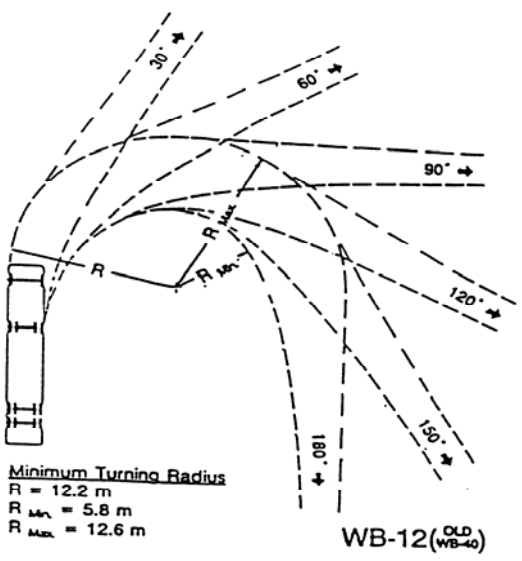
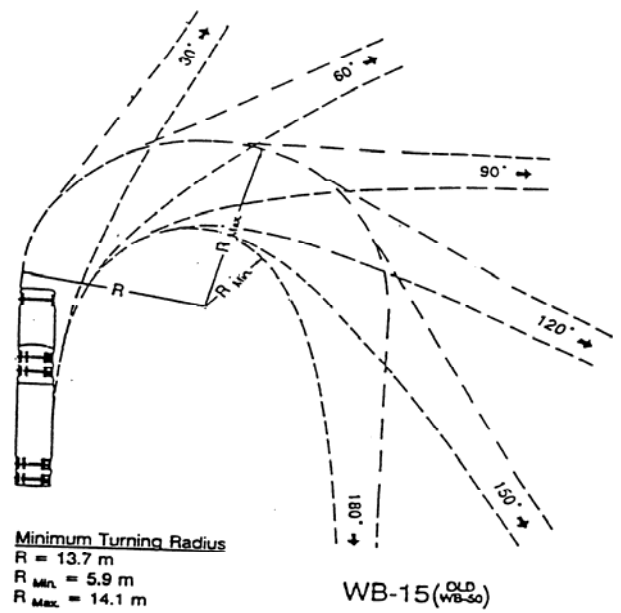
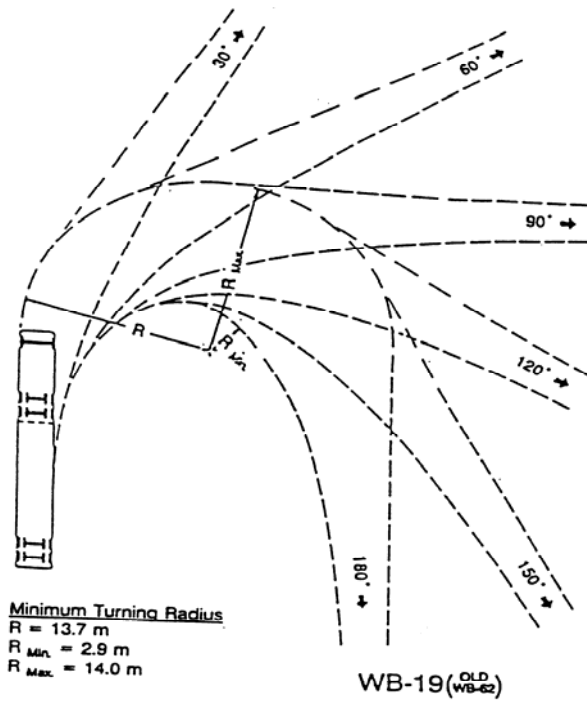

R = Left Front Wheel (path not shown)
 R_{Min} = Right Rear Wheel
 R_{Max} = Left Front Overhang

FIGURE C-1-5.7M
 (NOT TO SCALE)

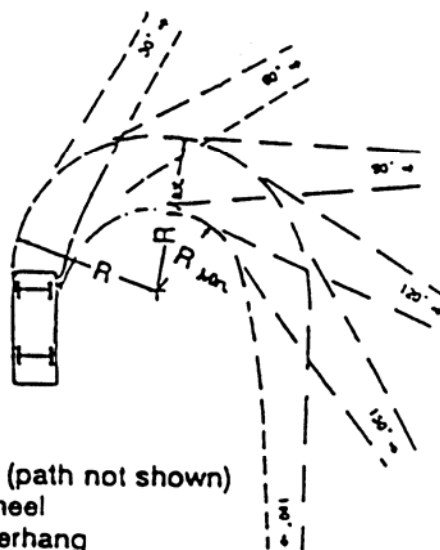

Minimum Turning Radius

R = 7.3 m Left Front Wheel (path not shown)

R_{Min} = 4.2 m Right Rear Wheel

R_{Max} = 7.8 m Left Front Overhang

P

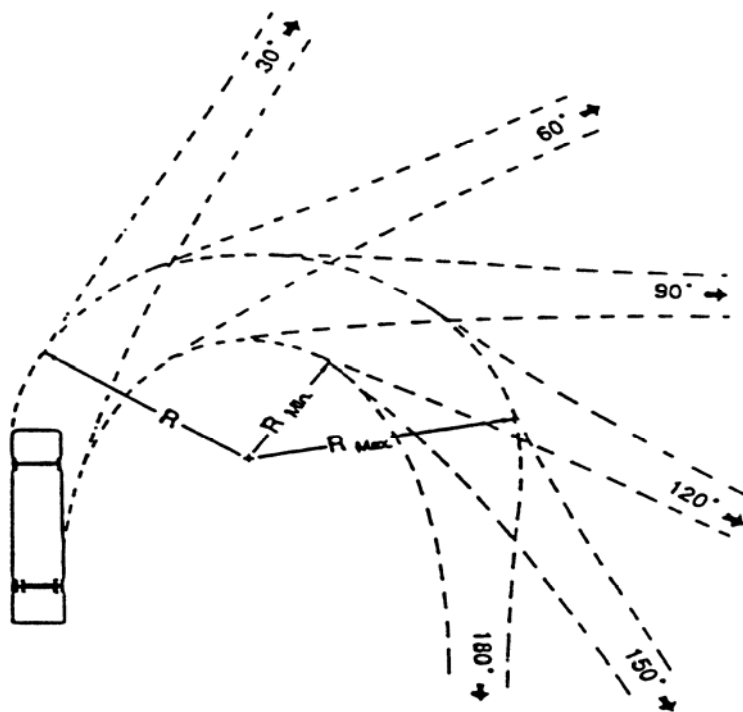

Minimum Turning Radius

R = 12.8 m Left Front Wheel (path not shown)

R_{Min} = 7.4 m Right Rear Wheel

R_{Max} = 14.1 m Left Front Overhang

BUS

FIGURE C-1-5.8M

(NOT TO SCALE)

SIGHT DISTANCE

Sight distances exceeding those shown in Table C-1-3M should be used as the basis for design wherever practical. When a highway is on a grade, the equation for braking distance should be modified in accordance with AASHTO's A Policy on Geometric Design of Highways and Streets.

The following tables are to be used in developing plans for all roadway systems:

Height of Eye 1.08 m							Height of Object 0.6 m			
DESIGN SPEED (KM/H)TT	30	40	50	60	70	80	90	100	110	120
MINIMUM SIGHT DISTANCE (M)	35	50	65	85	105	130	160	185	220	250
MINIMUM K VALUE FOR:										
CREST VERTICAL CURVES	2	4	7	11	17	26	39	52	74	95
SAG VERTICAL CURVES	6	9	13	18	23	30	38	45	55	63

STOPPING SIGHT DISTANCE

TABLE C-1-3M

K Value is a coefficient by which the algebraic difference in grade may be multiplied to determine the length in feet of the vertical curve that will provide minimum sight distance.

Height of Eye 1.08 m				Height of Object 1.08 m			
Design Speed (km/h)**	50	60	70	80	90	100	110
MINIMUM SIGHT DISTANCE (M)	345	410	485	540	615	670	730

PASSING SIGHT DISTANCE

TABLE C-1-4M

**For all tables, if the Design Speed is unknown, it may be assumed to be the posted speed limit unless the operating speed is lower at that point.

Each designer is to review the plans to determine if passing zones have been provided in the design to the best practical extent. The generally accepted method of checking passing sight distance is graphically by the use of a straight edge along the profile while comparing same to the horizontal alignment. These minimum passing sight distances for design are not to be confused with other distances used as warrants for placing no-passing zone pavement stripes on completed highways. Such values as shown in the Manual on Uniform Traffic Control Devices are substantially less than design distances and are derived for traffic operating control needs which are based on assumptions different from the passing sight distance used for highway design.

Height of Eye 1.08 m		Height of Object 1.08 m								
Design Speed (km/h)**	30	40	50	60	70	80	90	100	110	120
2 Lane Major Road	65	85	105	130	150	170	190	210	230	255
4 Lane Major Road (Undivided)	70	90	115	135	160	180	205	225	245	270
4 Lane Major Road (Divided – 5.4 m Median)	75	100	125	150	175	195	220	245	270	295

**INTERSECTION* SIGHT DISTANCES ALONG MAJOR ROAD AT INTERSECTION
WITH MINOR ROADS, CROSSOVERS AND COMMERCIAL ENTRANCES**

TABLE C-1-5M

**For all tables, if the Design Speed is unknown, it may be assumed to be the posted speed limit unless the operating speed is lower at that point.

For major roadways of more than four lanes, large truck volumes on a minor road or crossover, see AASHTO's A Policy on Geometric Design of Highways and Streets.

The designer must check each intersection to insure that these values are obtained. Any deficiency which cannot be corrected is to be brought to the attention of the State Location and Design Engineer.

On a typical two-lane road horizontal curve there are numerous objects that restrict sight distance such as, cut slopes, buildings, vegetation, vehicles, etc. It is very possible to have sight distance in the winter and not in the spring or summer due to the growth of vegetation.

* Rev. 1/06

These obstructions should be considered when reviewing commercial entrances. A divided highway can have similar problems. It is very important to obtain adequate commercial entrance sight distance from the entrance as well as the left turn position into the entrance. A design exception must be granted by the State Location and Design Engineer (or designee), and if applicable, the Federal Highway Administration for deviating from required sight distance standards.

The term "Major Road" refers to the major of the intersecting roads.

Intersection Sight Distance values in Table C-1-5M permit a vehicle stopped on minor road or crossover, to cross the major road safely or merge safely in the case of turns.

For the minimum lengths of vertical curves for the recommended stopping sight distance for each design speed, and corresponding "K" values, see AASHTO "Green Book".*

* Rev. 1/07

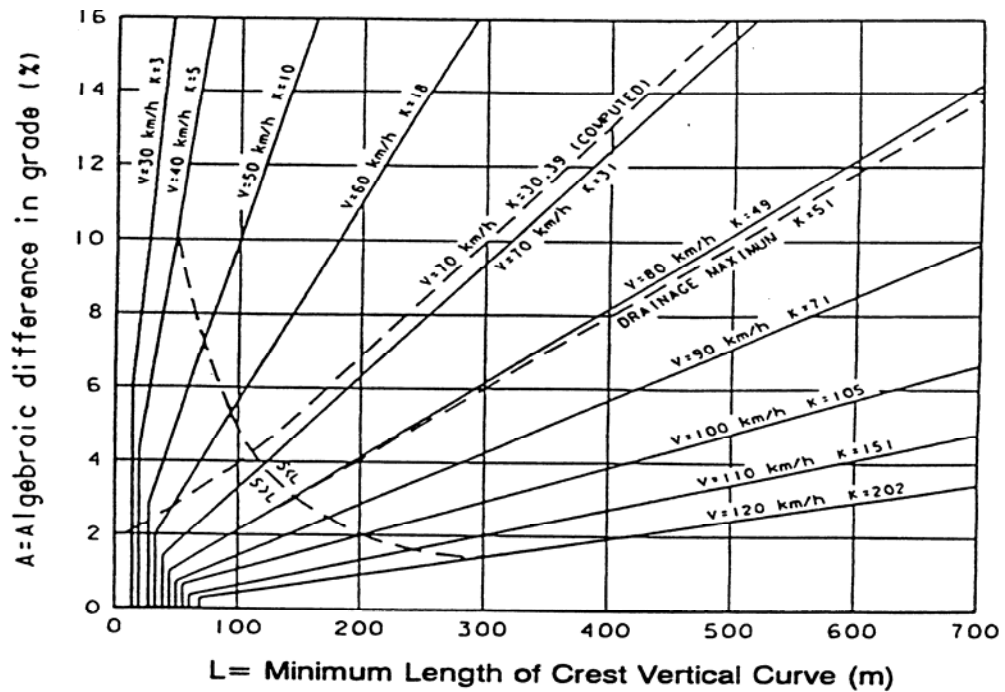

**DESIGN CONTROLS FOR CREST VERTICAL CURVES,
FOR STOPPING SIGHT DISTANCE AND OPEN ROAD CONDITIONS.**

FIGURE C-1-6M

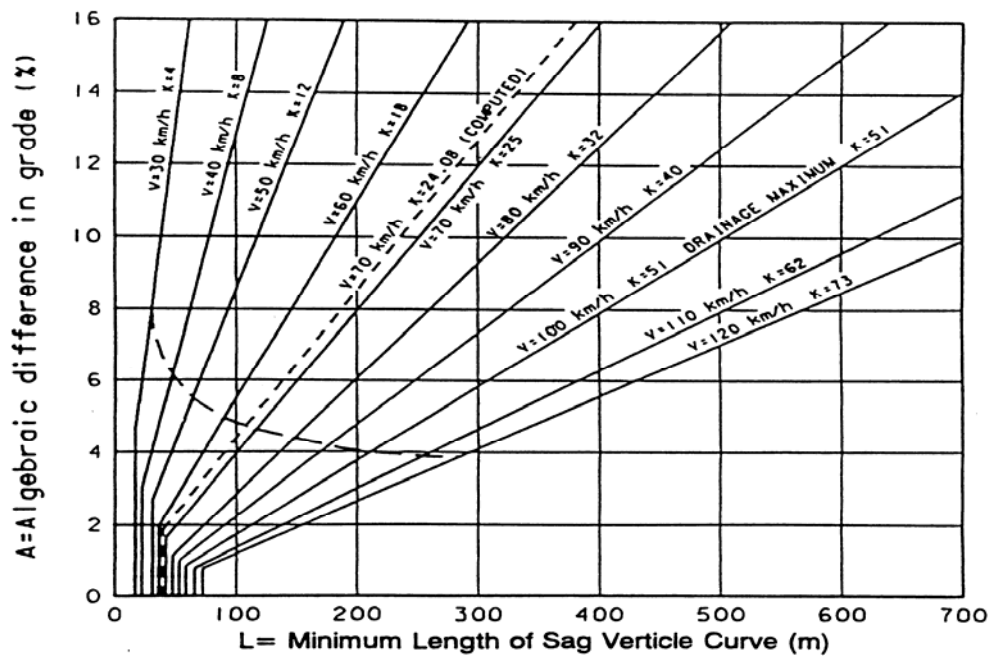

**DESIGN CONTROLS FOR SAG VERTICAL CURVES,
OPEN ROAD CONDITIONS.**

FIGURE C-1-7M

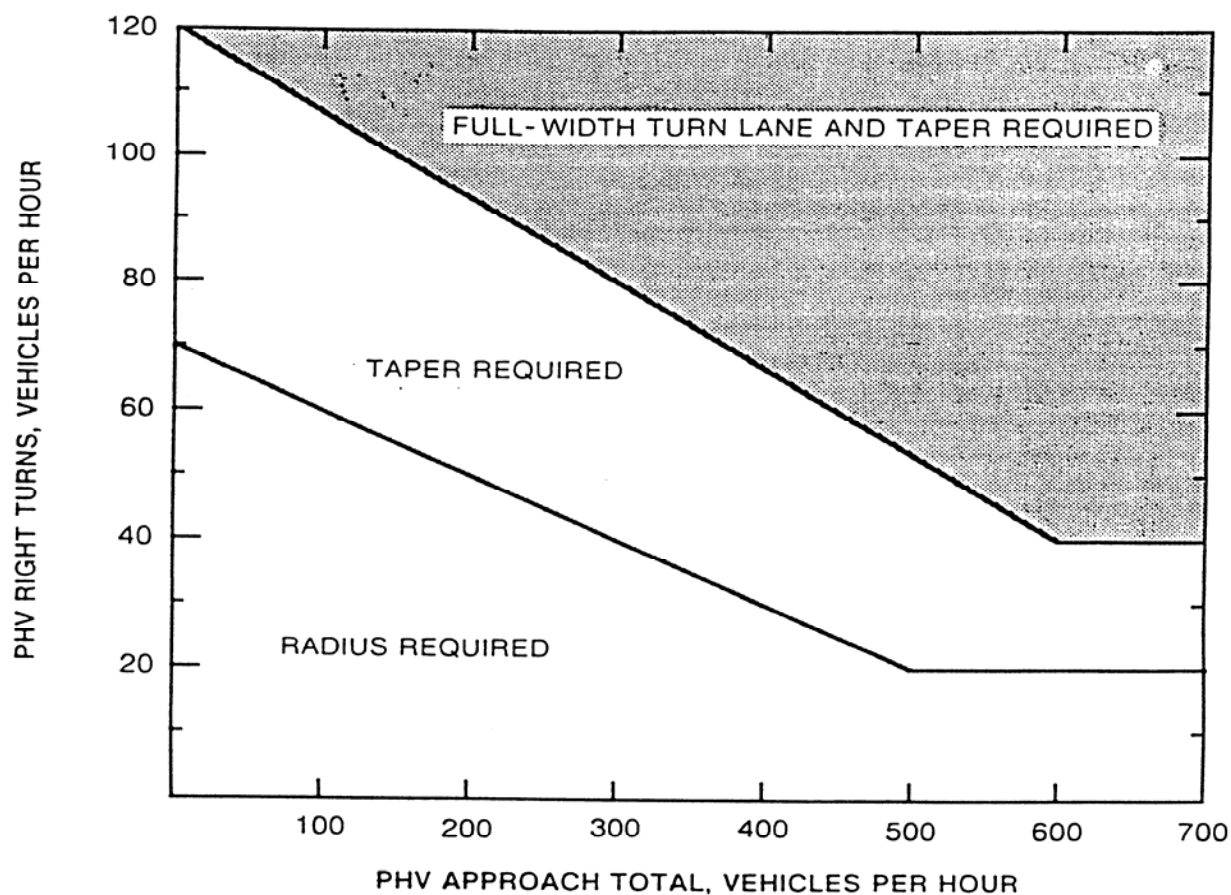

LEGEND

PHV - Peak Hour Volume (also Design Hourly Volume equivalent)

Adjustment for Right Turns

For posted speeds at or under 70 km/h (45 mph), PHV right turns > 40, and PHV total < 300.

Adjusted right turns - PHV Right Turns - 20

If PHV is not known use formula: $PHV = ADT \times K \times D$

K = the percent of AADT occurring in the peak hour

D = the percent of traffic in the peak direction of flow

Note: An average of 11% for K x D will suffice.

GUIDELINES FOR RIGHT TURN TREATMENT (2-LANE HIGHWAY)

FIGURE C-1-8M

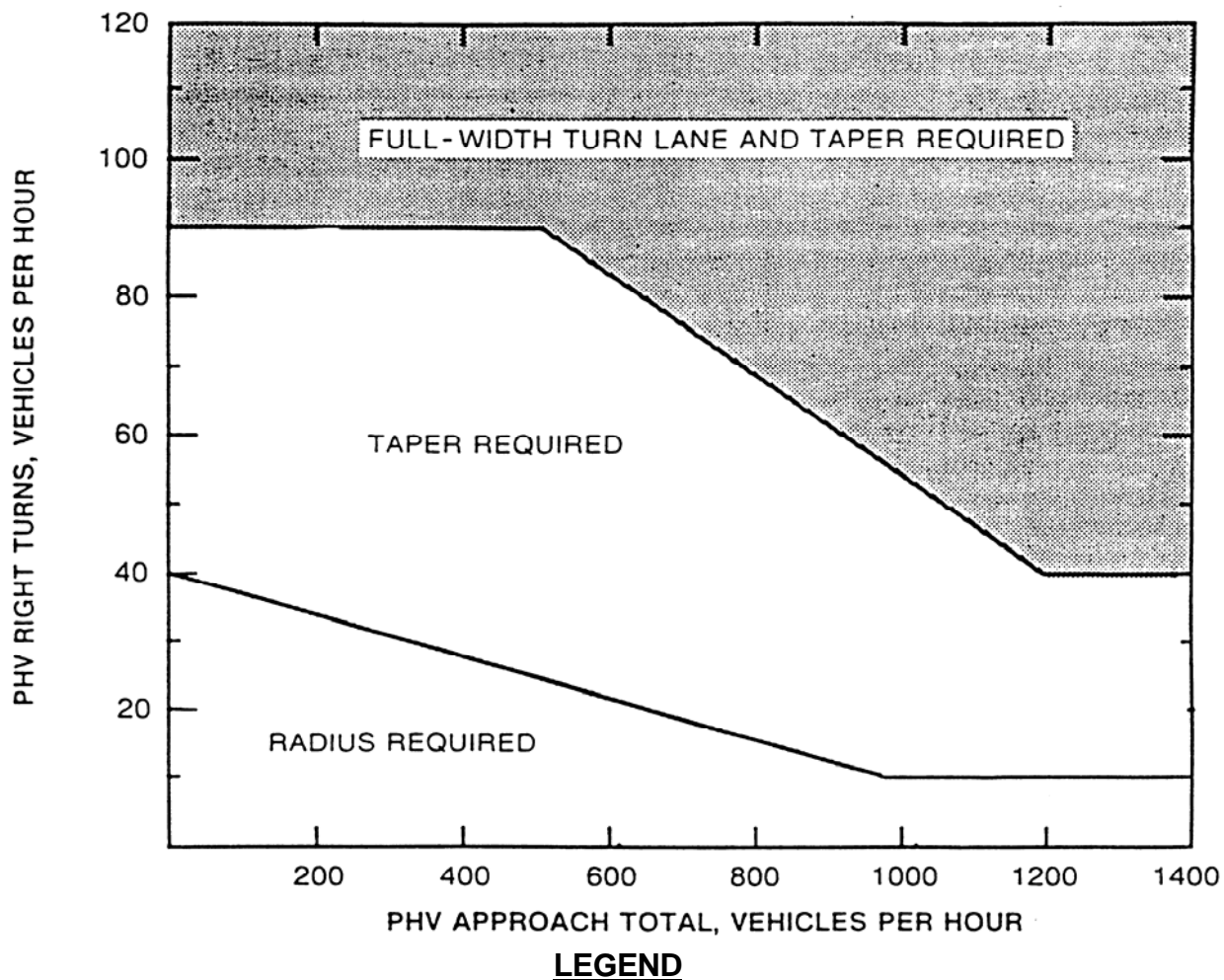

PHV - Peak Hour Volume (also Design Hourly Volume equivalent)

Adjustment for Right Turns

If PHV is not known use formula: $PHV = ADT \times K \times D$

K = the percent of AADT occurring in the peak hour
D = the percent of traffic in the peak direction of flow

Note: An average of 11% for K x D will suffice.

GUIDELINES FOR RIGHT TURN TREATMENT (4-LANE HIGHWAY)

FIGURE C-1-9M

RIGHT TURN LANES

In general, when right-turn volumes are higher than 300 vehicles per hour (vph) and adjacent mainline volume is also higher than 300 vph, an exclusive right-turn lane should be considered. Double exclusive right-turn lanes may be provided when the right-turn volume is higher than 350 vph. Safety implications associated with pedestrians and bicyclists should always be considered.*

These guidelines are to be used as an aid in selecting appropriate treatments for right turn movements. (Reference material attained from Virginia Highway and Transportation Research Council report "The Development of Criteria For the Treatment of Right Turn Movements on Rural Roads" dated March 1981.)

1. Number of Lanes - Guidelines are differentiated on the basis of the number of lanes on the major roadway. Refer to Figure C-1-8M for 2-lane roadways and Figure C-1-9M for 4-lane roadways. The minor roadway is a 2-lane road. Discussion on both figures is provided. All volumes refer to the volumes on the approach under consideration for right turn treatments.
2. Radius Treatment - Figure C-1-8M contains guidelines for right turn treatment on 2-lane roadways. The predominant treatment for 2-lane roadways is the radius. Arterial roadways tend to carry higher volumes of traffic traveling at higher speeds as compared to local roadways. The traffic on local roadways tends to include a higher number and percentage of right-turning vehicles than that on arterials. An adjustment is needed to permit local roadways to handle more right turns (at lower speeds) compared to arterial roads. The following adjustment is made for posted speeds at or under 70 km/h:

Adjusted Number of Right Turns = Number of Right Turns - 20 for number right turns > 40 and total volume < 300 vph

For example, let total volume = 200 vph, right turn volume = 70 vph and posted speed = 65 km/h (40 mph). Then adjusted number of right turns - $r = 70 - 20 = 50$. Therefore, entering Figure C-1-8M with a total volume 200 vph and $r=50$ vph, a radius is recommended as the right turn treatment.

Taper treatment - A taper is recommended for a primary route with a right turn, unless the volume conditions require a full-width turn lane or the percentage of right-turning vehicles make up less than 10% of the total traffic, in which case a radius is suggested.

3. Figure C-1-9M contains guidelines for 4-lane roadways. Four-lane roadways tend to have a taper or full-width lane to facilitate right turn movements. Many of these roads are divided highways with a speed limit of 90 km/h.
4. Other factors - The selection of a treatment for right turn movements may be influenced by sight distance, availability of right of way, grade, and angle of turn. Although these factors are not incorporated in the guidelines, they should be given consideration. The guidelines should be used unless the Engineer determines that special treatment is necessary due to other factors.
5. Data collection procedures - In order to employ these guidelines, peak hour volume data must be obtained from the Traffic Engineering* Division or Transportation and Mobility Planning Division, as appropriate.

Note: Figure C-1-1M should also be used for right turn storage and taper lengths. However, a capacity analysis should be performed for intersection capacity and signalization requirements.

ENTRANCES

Title 33.1-89 of the Code of Virginia, as amended, requires that projects have the alignment, profile, and grade of private entrances shown on plans.

This information is to be shown as follows:

1. When the proposed entrance is to be placed in the same location as the existing entrance, no alignment will be shown. The proposed entrance will be shown graphically.
2. Where a proposed entrance is to be on a location different from the existing, the proposed location will be shown graphically on the field inspection plans. After the field inspection party has reviewed the proposed location, the Right of Way and Utilities Division will contact the property owner and determine that the proposed location is satisfactory or that the property owner desires some other location. The designer will then request the centerline and profile to be run by the survey party when this cannot be secured from existing notes. This alignment is to be shown on the plans.
3. A profile and proposed grade is to be shown for each entrance where it is necessary to regrade on existing or new location. The survey party runs a profile along every existing entrance using a data collector and converting the information for placement into a graphics file. The profile is generally run along the center of the existing entrance, although usually no alignment is taken. The proposed grade can be a spline grade with an approximate percent of grade shown. The proposed grade will begin at the edge of shoulder; back of curb; or back of sidewalk, sidewalk space, or bikeway

whichever is the outermost permanent construction. If it is necessary to use some other beginning point, it should be identified on the profile.

It is desirable that projects with a large number of entrances contain a separate profile sheet or sheets devoted to entrances.

4. A note is to be included on the general notes sheet as follows: "When no baseline alignment is shown for a proposed entrance, the entrance is to be constructed in the same location as the existing entrance."
5. **The above information does not apply to No Plan Projects.***

Title 33.1-199 of the Code of Virginia, as amended, provides that any entrance disturbed in the repair or construction of a highway be replaced. This entrance is to be left in the same condition as it was prior to such repair or improvement.

1. Whenever plans have been prepared for a proposed improvement and submitted to the district for field inspection, the plans will show the entrances in place as called for by the engineering information at the time the plans were prepared. The field inspection team shall make a close inspection of all entrances on the project and provisions are to be made to replace such entrances.
2. In reviewing the plans, there may be instances where a landowner now has access to his property by reason of the fact that he is able to drive from the highway surface to this adjoining property, particularly in farming operations, in order to obtain access to various fields within the farm. This must be carefully studied and, if the farm is so arranged that this is found to be true, the provisions are to be made to provide field entrances as conditions would require.
3. No additional entrances are to be called for or shown on the plans.
4. The right of way is to be appraised and acquired in accordance with the approved plans and the entrances that are shown thereon. (Should it be discovered at the appraising or negotiating stage that an existing entrance has been overlooked or added by the owner since the time of field inspection, then, of course, this entrance will be replaced.) There will, of course, be instances when the owner requests the construction of an entrance to a property where no access exists or for the construction of an additional entrance. When this occurs, the owner's request can be complied with if it is determined that construction of the entrance is economically justified and the District Administrator and District Traffic Engineer give their approval for the construction thereof.
5. The applicable details shown CADD Cell "PCENTR" at <http://www.extranet.vdot.state.va.us/locdes/caddman/html/frameset.htm> are to be placed on the typical section sheet.

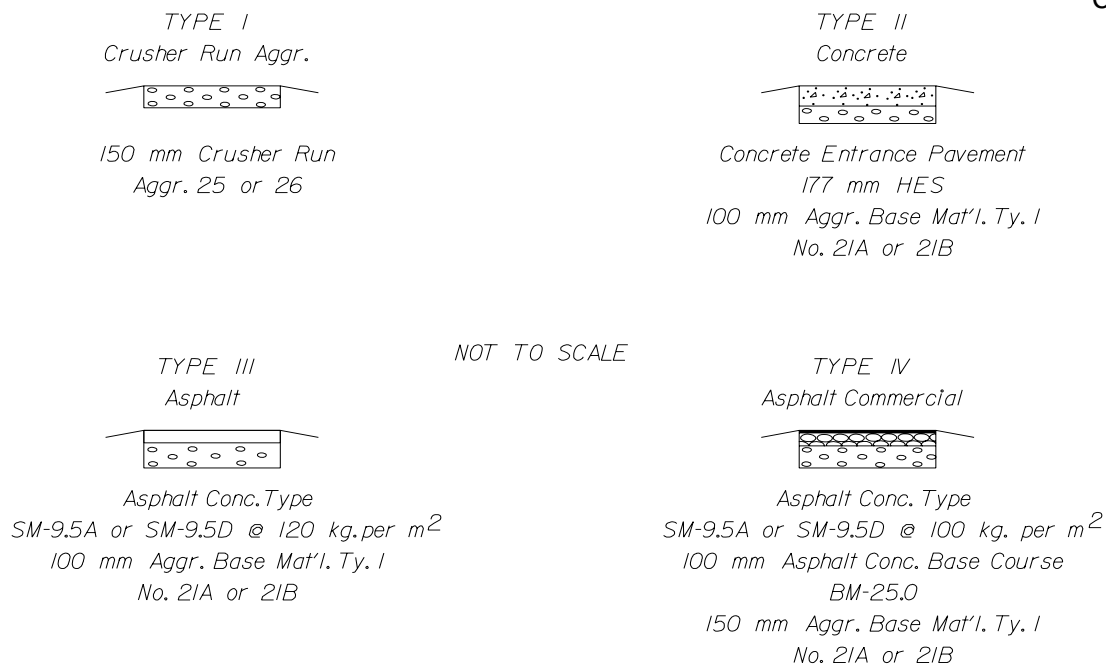

*The type of entrance (I, II, III, IV) to be constructed
will be determined by the existing condition at the
time of construction.*

PRIVATE AND COMMERCIAL ENTRANCES

FIGURE C-1-10M

SAFETY REST AREAS

Design guides for safety rest areas are shown on Figure C-1-11M and Figure C-1-12M. Rest areas along the roadways are functional and desirable elements on heavily traveled roads and on those carrying recreational traffic. They are a part of the complete highway development provided for the safety and convenience of the roadway users. The design and location of rest areas depends much on the character and volume of traffic, type of highway and adjacent land use and should consider the scenic quality of the area, accessibility and adaptability to development. Other essential considerations include an adequate source of water and a means to treat and/or properly dispose of sewage. Site plans should be developed by the use of a comprehensive site planning process that should include the location of ramps, parking areas, buildings, picnic areas, water supply, sewage treatment facilities and maintenance areas. The objective is to give maximum weight to the appropriateness of the site rather than adherence to constant distance or driving time between sites.

Principles of ramp terminal design apply generally at the points of access to or from these areas. The designer is to refer to [IIM LD- 20](#) in the design of ramp terminal and speed change lane criteria. Figures C-1-13M and C-1-14M are to be used as guides for the selection of the parking space arrangement for cars and trucks. Parking spaces and access aisles shall be designed with surface slopes not to exceed 1:50 (2%) in all directions.

PARKING SPACES

Where parking spaces are provided, accessible spaces for persons with mobility impairments should comply with the following table:

Total Parking in Lot	Required Minimum Number Accessible Spaces
1 to 25	1
26 to 50	2
51 to 75	3
76 to 100	4
101 to 150	5
151 to 200	6
201 to 300	7
301 to 400	8
401 to 500	9
501 to 1000	2 percent of total
1001 and over	20 plus 1 for each 100 over 1000

Source: The most recent Americans with Disabilities Act Accessibility Guidelines (ADAAG).*

Accessible parking spaces shall be at least 2440 mm wide. Access aisles adjacent to accessible spaces shall be 1525 mm wide minimum. One in every eight accessible spaces, but not less than one, shall be served by an access aisle 2440 mm wide minimum and shall be designated "van accessible". Two accessible parking spaces may share a common access aisle (see Figure C-1-10.1M).

The "Universal Parking Space Design" is an acceptable alternative to providing a percentage of spaces with a 2440 mm wide aisle. Under this design all accessible spaces are a minimum of 3350 mm wide with 1525 mm wide access aisles. Since all spaces using this design are van accessible, no additional signage is needed to denote which spaces will accommodate vans. This design allows vehicles to park to one side or the other within the 3350 mm space.

Accessible parking spaces for persons with mobility impairments are to be located and designed to provide the shortest possible route to rest area facilities. If there are curbs between the access aisle and parking perimeter, then curb cut ramps, Standard CG-12, are to be provided. The Traffic Engineering Division and Environmental Division should be contacted to coordinate the signing and placement of curb cuts. Figure C-1-10.1M is to be used to provide ample space for the accessible loading area.

Parked vehicle overhangs shall not reduce the clear width of an accessible route. Accessible parking spaces shall be designated as reserved by a sign showing the symbol of accessibility. Van accessible spaces shall have an additional sign "Van-Accessible" mounted below the symbol of accessibility. Such signs shall be located so they cannot be obscured by a vehicle parked in the space. Provide minimum vertical clearance of 2895 mm at accessible passenger loading zones and along at least one vehicle access route to such areas from site entrance(s) and exit(s).

* Rev. 1/07

ACCESSIBLE PARKING AND PASSENGER LOADING ZONES

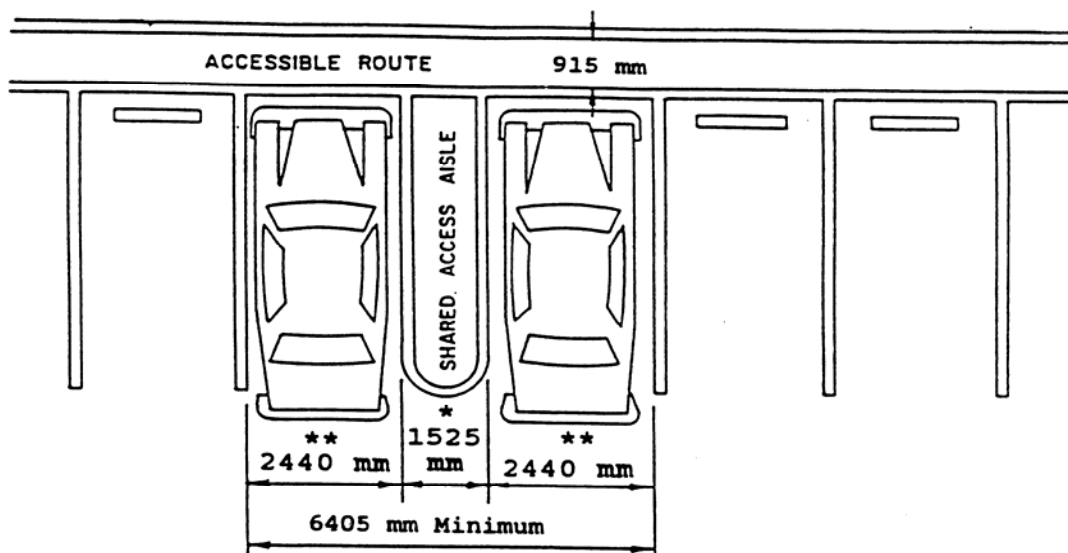

MINIMUM DIMENSIONS FOR ACCESSIBLE PARKING

** Universal Parking Spaces 3350 mm wide may be used. See instructions for "Parking Spaces" to determine number of * accessible spaces required.

* 2440 mm min. adjacent to spaces for vans designed for mobility impaired persons.

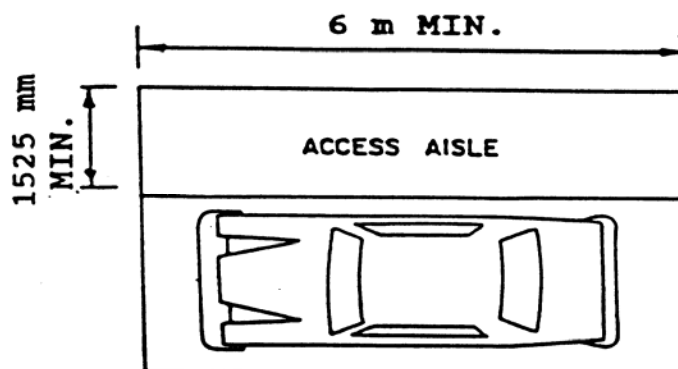

ACCESS AISLE FOR ACCESSIBLE LOADING ZONES

Source: The most recent Americans with Disabilities Act Accessibility Guidelines (ADAAG).*

NOTES:

LOCATION: Parking spaces for persons with mobility impairments and accessible passenger loading zones that serve a particular building shall be located on the shortest possible accessible circulation route to an accessible entrance of the building. In separate parking structures or lots that do not serve a particular building, accessible parking spaces shall be located on the shortest possible circulation route to an accessible pedestrian entrance of the parking facility.

PASSENGER LOADING ZONES: If there are curbs between the access aisle and the vehicle pull-up space, then a Standard CG-12 Curb Ramp shall be provided.

DESIGNS FOR ACCESSIBLE PARKING SPACES

FIGURE C-1-10.1M

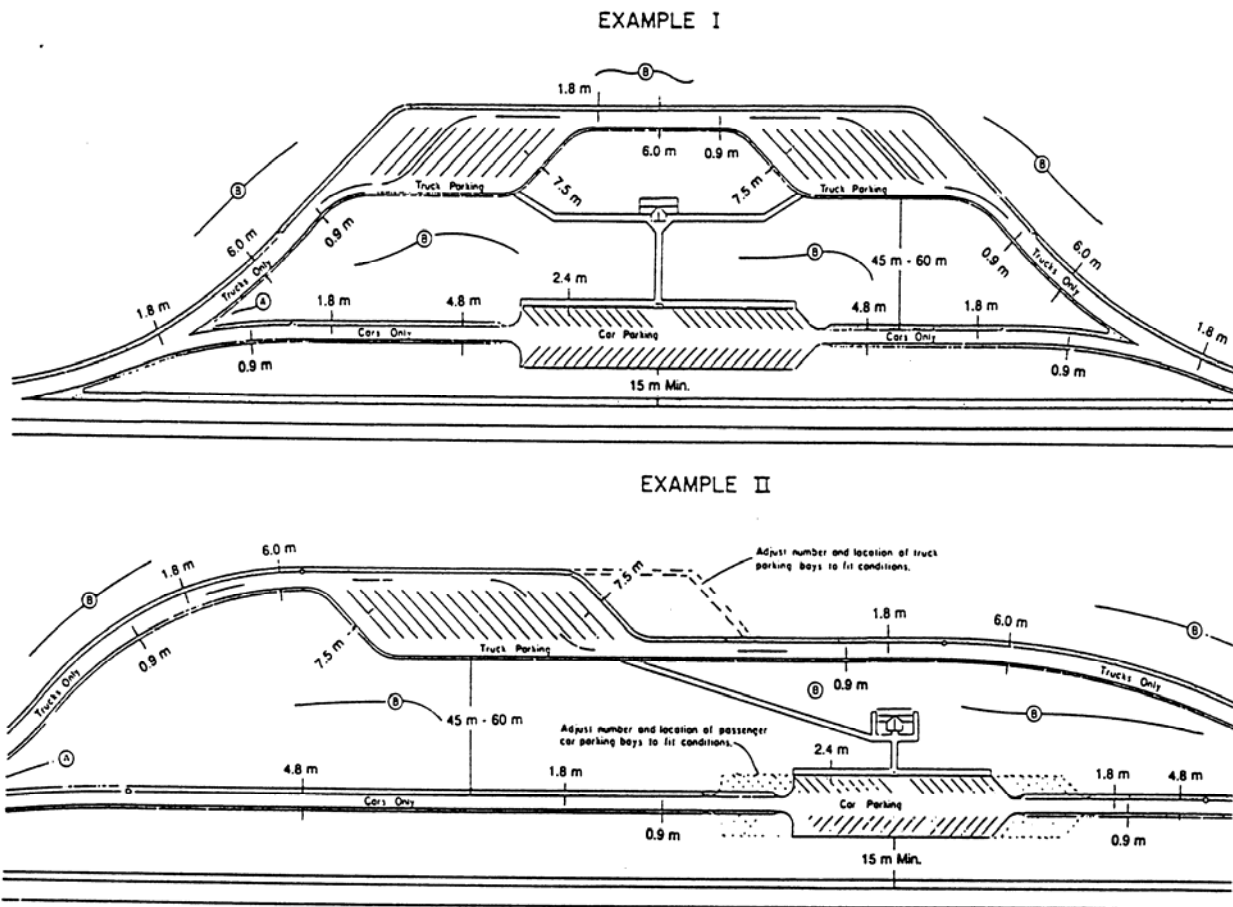

A Denotes areas to be cleared, grubbed, graded, topsoiled, and seeded.

B Denotes areas NOT to be cleared and grubbed except for areas within roadway and parking area construction limits

NOTE: See Figure C-1-12M for additional areas.

DESIGN GUIDE FOR SAFETY REST AREAS

FIGURE C-1-11M

EXAMPLE III

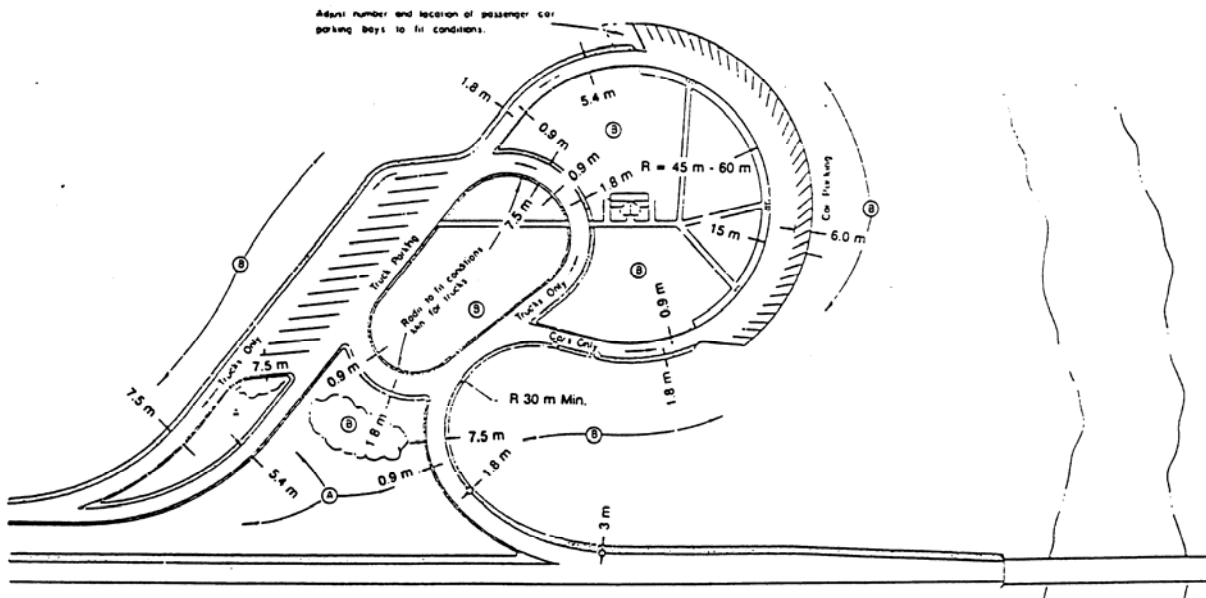

- A Denotes areas to be cleared, grubbed, graded, topsoiled, and seeded.
- B Denotes areas NOT to be cleared and grubbed except for areas within roadway and parking area construction limits

NOTES

Design types are to receive the approval of the Environmental Division.

Individual radii; length of ramps; individual ramp configuration, etc. are to be designed to fit the individual site conditions.

Design and dimensions shown hereon are approximate only.

Well and septic drainage field locations are to be recommended by the District Landscape representative. Testing and approval of soil conditions are to be obtained by the Environmental Division through the appropriate County and State agencies. Additional right of way for drain field should be acquired if necessary.

The proposed right of way limits should be discussed with the Environmental Division after preparation of the plan and grade lines in order that adequate area for required facilities will be obtained.

A single line of fence in median is to be specified if opposite rest areas are accessible, or if medians can be readily crossed by pedestrians. This fence should extend between points a minimum of 60 meters (200 feet) beyond ramp noses. Fencing in outer separator may be required because of site requirements.

Perimeter of rest area to be fenced unless otherwise recommended by the field party.

A note similar to the following is to be shown on the rest area detail sheet of all grading and drainage plans:

"No trees or shrub outside the limits of the rest area roadway construction are to be cut without the approval of the Landscape Engineer."

DESIGN GUIDE FOR SAFETY REST AREAS**FIGURE C-1-12M**

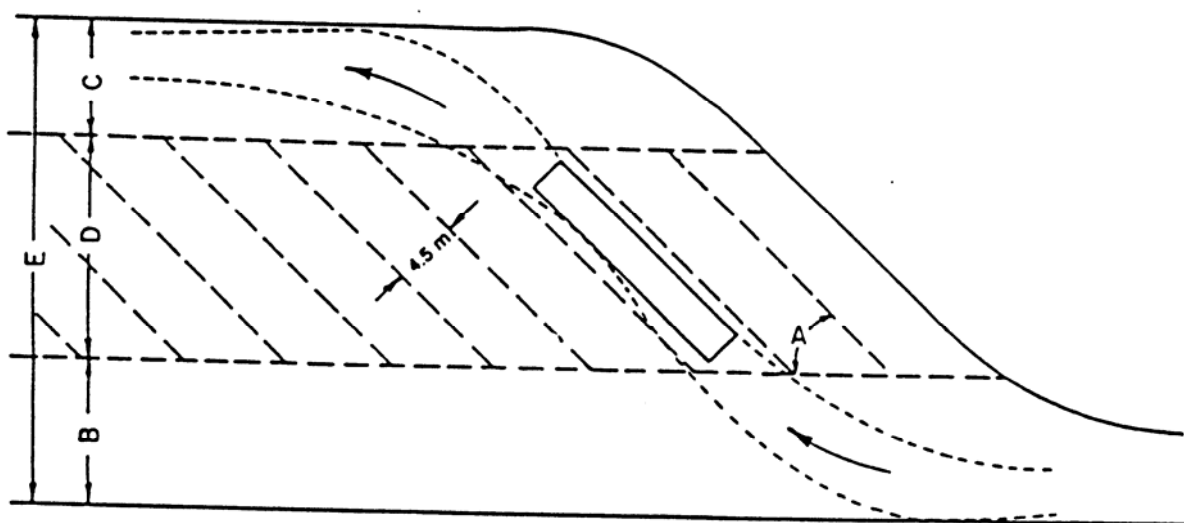

LEGEND

- A - ANGLE OF PARKING
- B - ENTRANCE ROADWAY WIDTH
- C - EXIT ROADWAY WIDTH
- D - PARKING WIDTH
- E - TOTAL WIDTH

DIMENSIONS FOR PARKING SPACES

ANGLE OF PARKING (DEGREES)	ENTRANCE ROADWAY WIDTH (METERS)	EXIT ROADWAY WIDTH (METERS)	PARKING WIDTH (METERS)		TOTAL WIDTH PARKING AREA (METERS)		NUMBER OF TRUCKS PARKED (PER HECTARE)	
			D	E	16.7 m (WB-15) DESIGN VEHICLE	25 m LENGTH DESIGN VEHICLE	16.7 m (WB-15) DESIGN VEHICLE	25 m LENGTH DESIGN VEHICLE
A	B	C						
30	6.0	6.0	12.3	16.5	24.3	28.5	44	38
45	9.0	7.5	15.2	21.0	31.7	37.5	48	41
60	12.0	9.0	16.8	24.0	37.8	45.0	49	42

FIGURE C-1-13M DESIGN FOR ANGLE PARKING OF TRUCKS

For additional information, see the most recent AASHTO's Guide for the Design of Park-and-ride Facilities.*

* Rev. 1/07

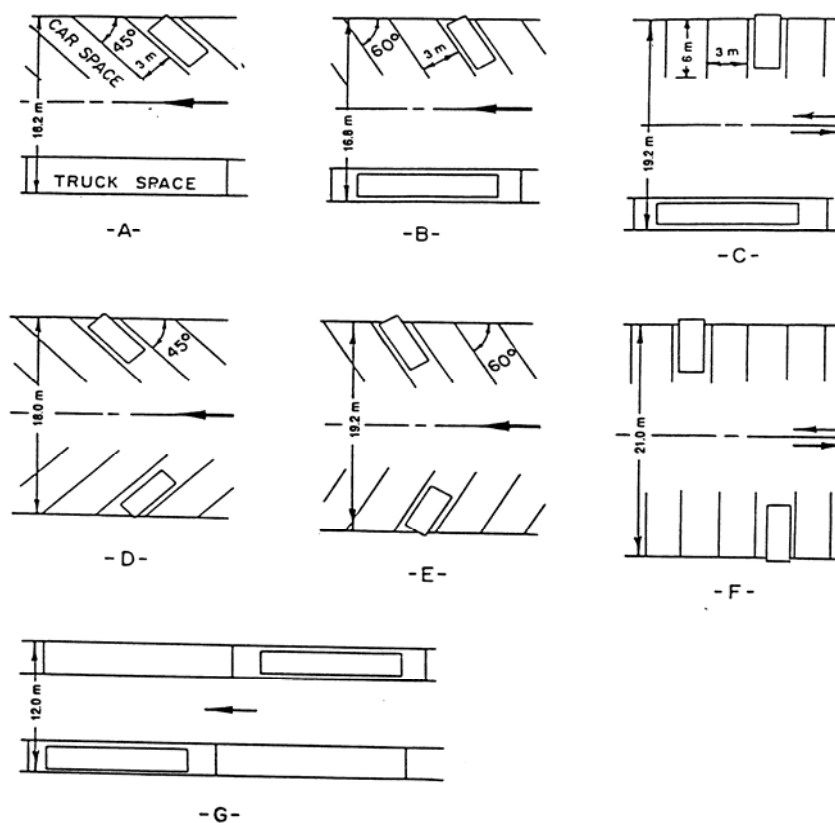

SUMMARY OF PARKING SPACE ARRANGEMENTS

Central Roadway	Type of Vehicle and Total Width		Number Vehicles Parking Area (meters)	Number Vehicles per 100 meters	
	Left	Right		Left	Right
A One-way	Trucks-parallel	Cars-45°	16.2	*	23
B One-way	Trucks-parallel	Cars-60°	16.8	*	28
C Two-way	Trucks-parallel	Cars-90°	19.2	*	33
D One-way	Cars-45°	Cars-45°	18.0	23	23
E One-way	Cars-60°	Cars-60°	19.2	28	28
F Two-way	Cars-90°	Cars-90°	21.0	33	33
G One-way	Trucks-parallel	Trucks-parallel	12.0	*	*

* For a WB-15 Design Vehicle a 20 meter space length is required = 5 spaces per 100 meters
 For a 25 meter Design Vehicle a 30 meter space length is required = 3.3 spaces per 100 meters

DESIGN FOR PARKING SPACES

FIGURE C-1-14M

For additional information, see the most recent AASHTO's Guide for the Design of Park-and-ride Facilities.*