

Appendix 8A-1      Definitions and Abbreviations

---

**Definitions:**

Culvert	<p>A structure which is usually designed hydraulically to take advantage of submergence to increase hydraulic capacity.</p> <p>A structure used to convey surface runoff through embankments.</p> <p>A structure, as distinguished from bridges, which is usually covered with embankment and is composed of structural material around the entire perimeter, although some are supported on spread footings with the streambed serving as the bottom of the culvert.</p> <p>A structure which is 20 ft or less in centerline length between extreme ends of openings for multiple boxes. However, a structure designed hydraulically as a culvert is treated as a culvert in this chapter, regardless of length.</p>
Critical Depth	<p>Critical depth is the depth at which the specific energy of a given flow rate is at a minimum. For a given discharge and cross-section geometry there is only one critical depth. Appendix 8C contains critical depth charts for different shapes.</p>
Flow Type	<p>The USGS has established seven culvert flow types which assist in determining the flow conditions at a particular culvert site. Diagrams of these flow types are provided in the design methods section.</p>
Free Outlet	<p>A free outlet has a tailwater equal to or lower than critical depth. For culverts having free outlets, lowering of the tailwater has no effect on the discharge or the backwater profile upstream of the tailwater.</p>
Improved Inlet	<p>An improved inlet has an entrance geometry, which contracts the flow as it enters the barrel thus increasing the capacity of culvert. These inlets are referred to as either side- or slope-tapered (walls or walls and bottom tapered).</p>
Normal Flow	<p>Normal flow occurs in a channel reach when the discharge, velocity and depth of flow do not change throughout the reach. The water surface and channel bottom will be parallel. This</p>

**Appendix 8A-1                      Definitions and Abbreviations**

---

type of flow will exist in a culvert operating on a constant slope provided the culvert is sufficiently long.

Slope                      A steep slope occurs where critical depth is greater than normal depth. A mild slope occurs where critical depth is less than normal depth.

Submerged                A submerged outlet occurs when the tailwater elevation is higher than the crown of the culvert. A submerged inlet occurs when the headwater is greater than 1.2D where D is the culvert diameter or barrel height.

**Abbreviations:**

AASHTO	American Association of State Highway and Transportation Officials
BLM	Bureau of Land Management
DCR	Department of Conservation and Recreation
FEMA	Federal Emergency Management Agency
FHWA	Federal Highway Administration
NRCS	National Resource Conservation Service; formerly Soil Conservation Service (SCS)
HDS	Hydraulic Design Series
HEC	Hydraulic Engineering Circular
HIRE	Highways in the River Environment
HW	Headwater
NFIA	National Flood Insurance Act
NFIP	National Flood Insurance Program
NOAA	National Oceanic and Atmospheric Administration
RDM	Road Design Manual
TVA	Tennessee Valley Authority
TW	Tailwater
USBR	United States Bureau of Reclamation
USCOE/USACE	United States Army Corps of Engineers
USGS	United States Geological Survey
VDOT	Virginia Department of Transportation

<u>Symbol</u>	<u>Definition</u>	<u>Units</u>
A	Area of cross section of flow	ft <sup>2</sup>
B	Barrel or box width	in or ft
C <sub>d</sub>	Overtopping coefficient (Weir coefficient)	-
C <sub>r</sub>	Discharge coefficient	-
D	Culvert diameter or barrel height	in or ft
d	Depth of flow	ft
d <sub>50</sub>	Mean stone size diameter	in or ft
d <sub>B</sub>	Critical depth at riprap basin overflow	ft
d <sub>c</sub>	Critical depth	ft
d <sub>E</sub>	Equivalent brink depth	ft
d <sub>n</sub> or d <sub>o</sub>	Normal depth	ft
F <sub>r</sub>	Froude Number	-
g	Acceleration due to gravity	ft/s <sup>2</sup>
H	Total headloss	ft
H <sub>b</sub>	Bend headloss	ft
H <sub>E</sub>	Entrance headloss	ft
H <sub>f</sub>	Friction losses	ft
H <sub>g</sub>	Grate losses	ft
H <sub>j</sub>	Junction losses	ft
H <sub>L</sub>	Total energy losses	ft
H <sub>o</sub>	Outlet or exit headloss	ft
h <sub>s</sub>	Depth of riprap basin	ft
H <sub>v</sub>	Velocity head	ft
h <sub>o</sub>	Hydraulic grade line height above outlet invert	ft
HW	Headwater depth (subscript indicates section)	ft
HW <sub>i</sub>	Headwater depth as a function of inlet control	ft
HW <sub>o</sub>	Headwater depth above outlet invert	ft
HW <sub>oi</sub>	Headwater depth as a function of outlet control	ft
HW <sub>r</sub>	Headwater depth above roadway	ft
K <sub>e</sub>	Entrance loss coefficient	-
k <sub>t</sub>	Submergence coefficient	-
L	Length of culvert or length of roadway crest	ft
L <sub>B</sub>	Length of riprap basin	ft
L <sub>s</sub>	Length of dissipating pool	ft
n	Manning's roughness coefficient	-
P <sub>w</sub>	Wetted perimeter	ft
Q	Discharge	cfs
Q <sub>d</sub>	Discharge through the culvert	cfs

**Appendix 8A-2**

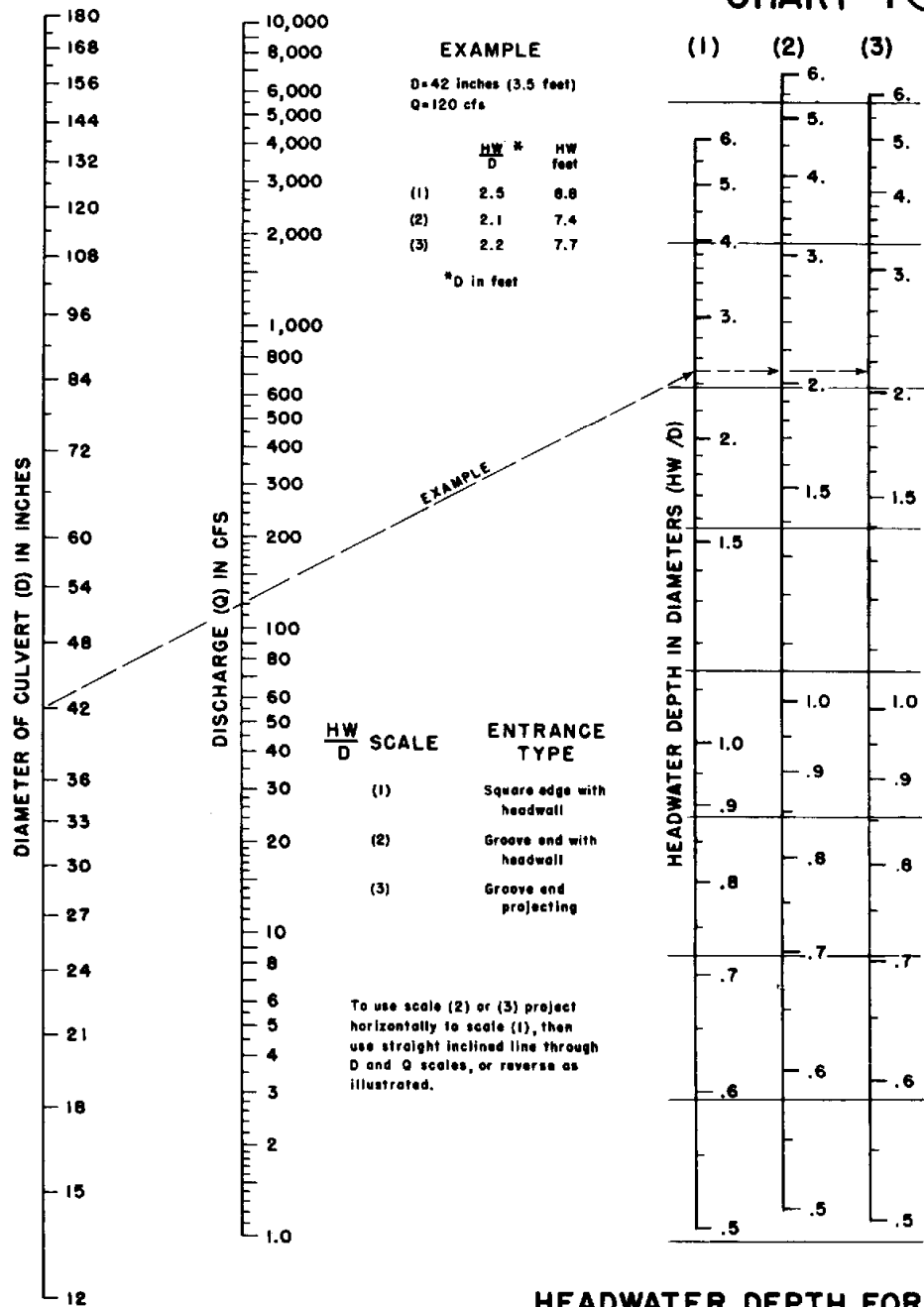
**Symbols**

---

<b><u>Symbol</u></b>	<b><u>Definition</u></b>	<b><u>Units</u></b>
$Q_t$	Design or check discharge at culvert	cfs
$R$	Hydraulic radius (A/P)	ft
$S_o$	Slope of culvert	ft/ft
TW	Tailwater depth above invert of culvert	ft
$V$	Average velocity of flow	fps
$V_B$	Average velocity at riprap basin overflow	fps
$V_d$	Average velocity in downstream channel	fps
$V_L$	Average velocity at length (L) downstream from brink	fps
$V_o$	Average velocity of flow at culvert outlet	fps
$V_u$	Average velocity in upstream channel	fps
$W_B$	Width of riprap basin at overflow	ft
$W_o$	Width dimension of culvert shape	ft
$\gamma$	Unit weight of water	lbs/ft <sup>3</sup>



CHART 1 



**HEADWATER DEPTH FOR  
 CONCRETE PIPE CULVERTS  
 WITH INLET CONTROL**

HEADWATER SCALES 2 & 3  
 REVISED MAY 1964

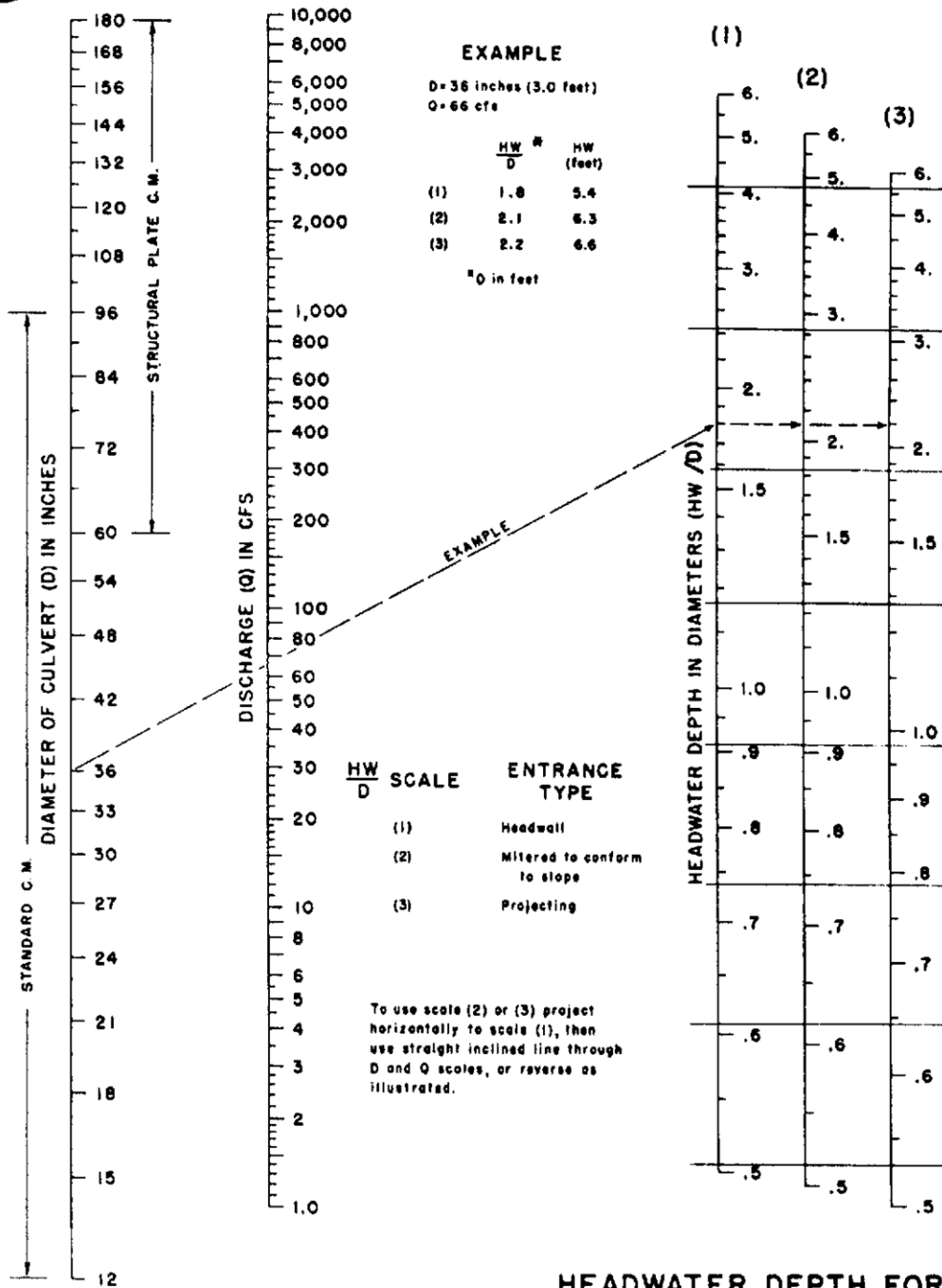
BUREAU OF PUBLIC ROADS JAN. 1963

Source: HDS -5

Appendix 8C-2 Inlet Control, Circular Corrugated Metal



CHART 2



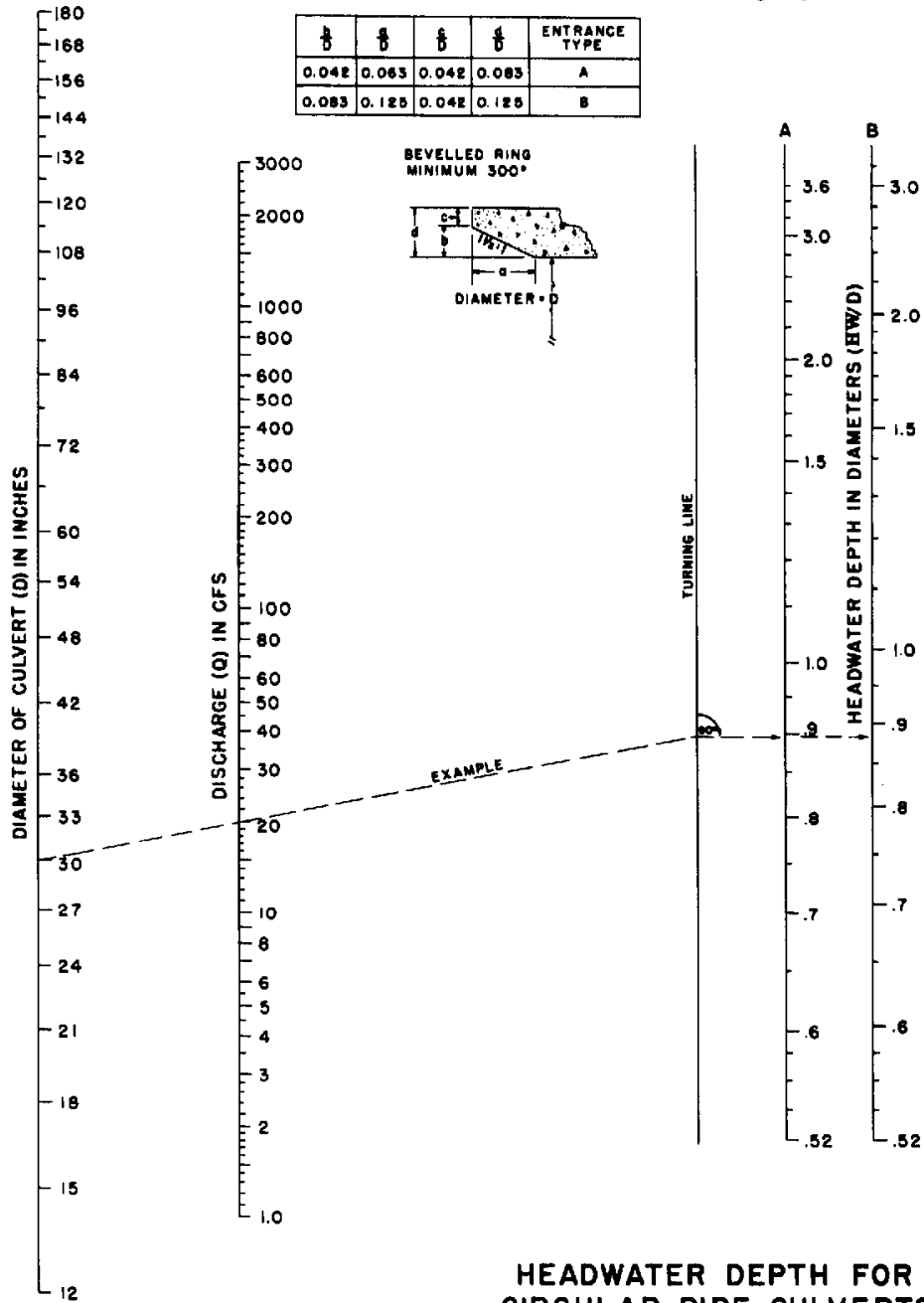
HEADWATER DEPTH FOR C. M. PIPE CULVERTS WITH INLET CONTROL

BUREAU OF PUBLIC ROADS JAN. 1963

Source: HDS-5

Appendix 8C-3 Inlet Control, Circular with Beveled Ring

CHART 3



FEDERAL HIGHWAY ADMINISTRATION  
MAY 1973

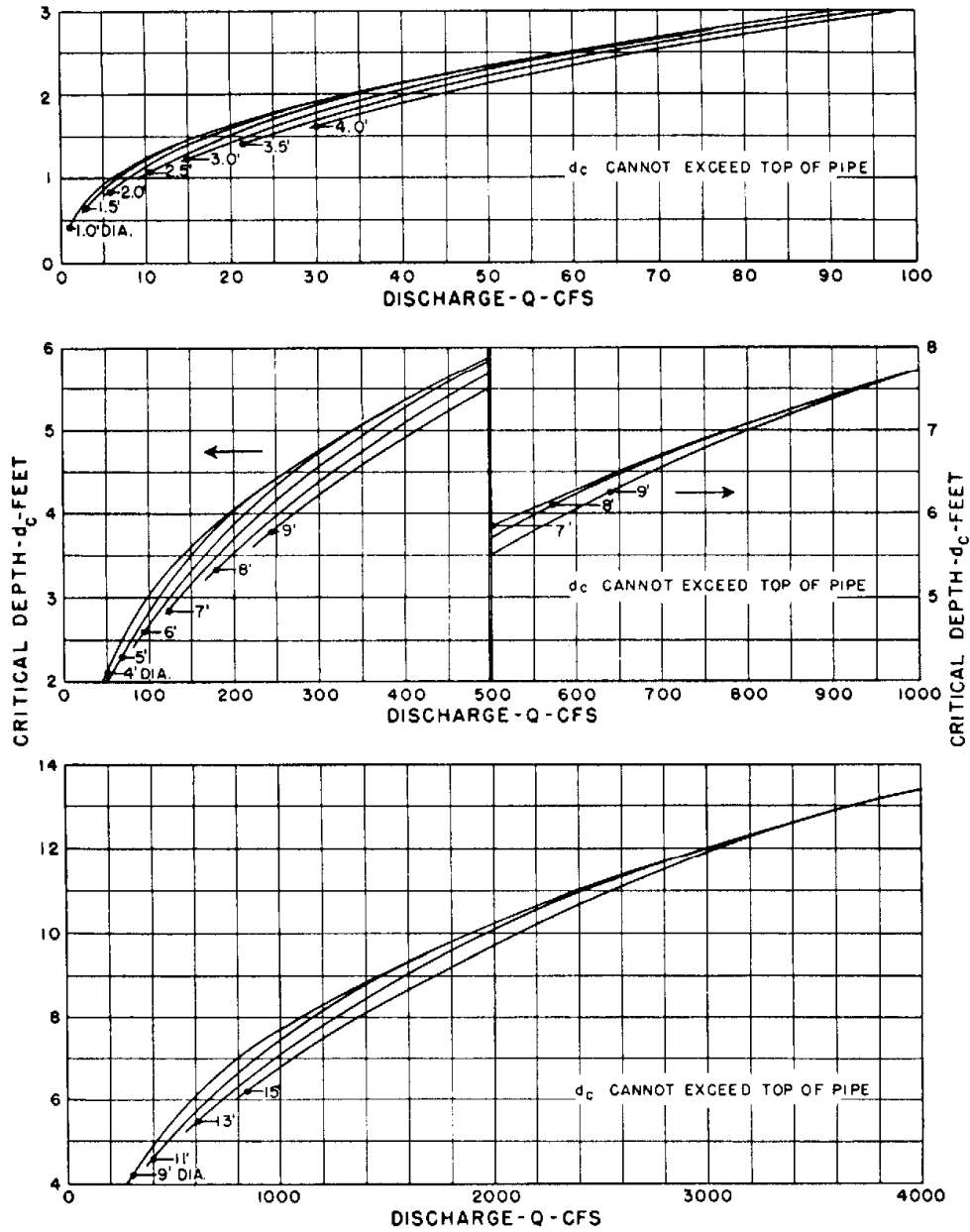
HEADWATER DEPTH FOR  
CIRCULAR PIPE CULVERTS  
WITH BEVELED RING  
INLET CONTROL

Source: HDS-5





CHART 4



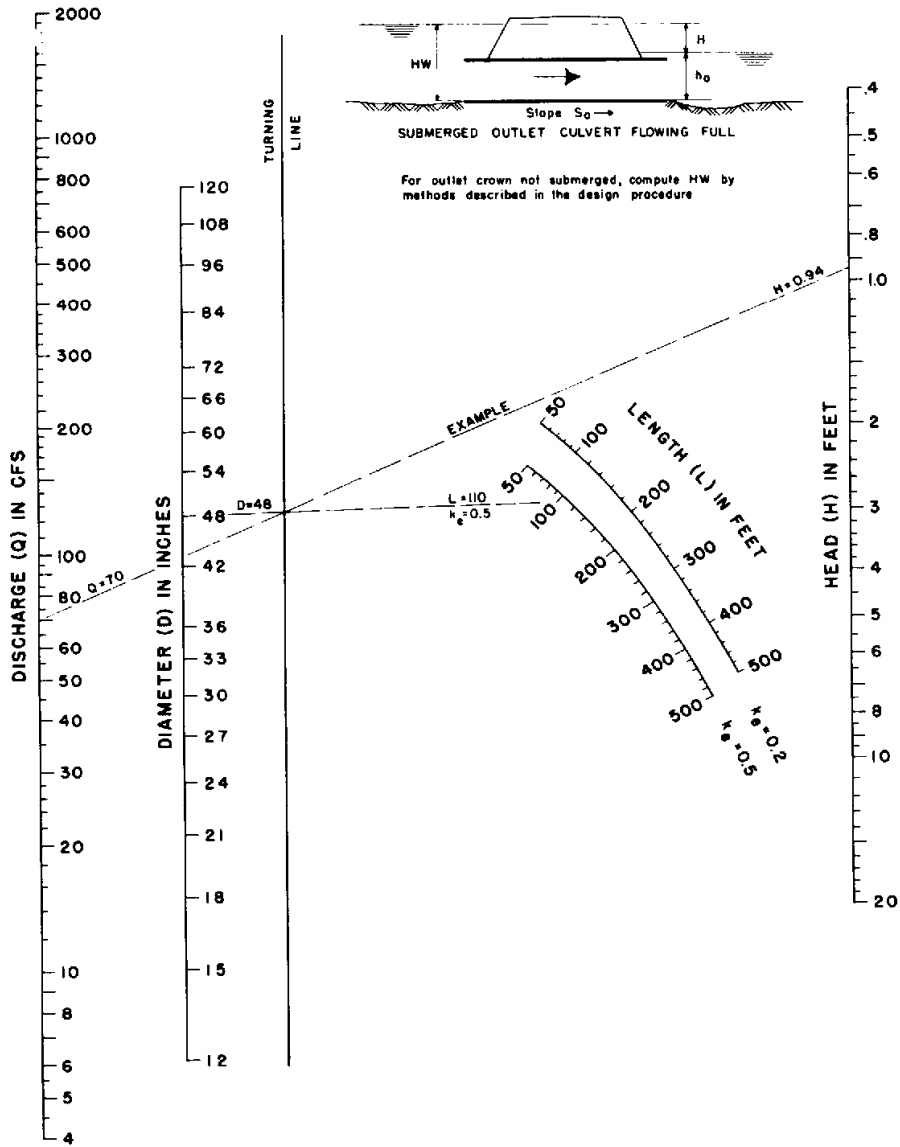
BUREAU OF PUBLIC ROADS  
JAN. 1964

**CRITICAL DEPTH  
CIRCULAR PIPE**

Source: HDS-5



CHART 5



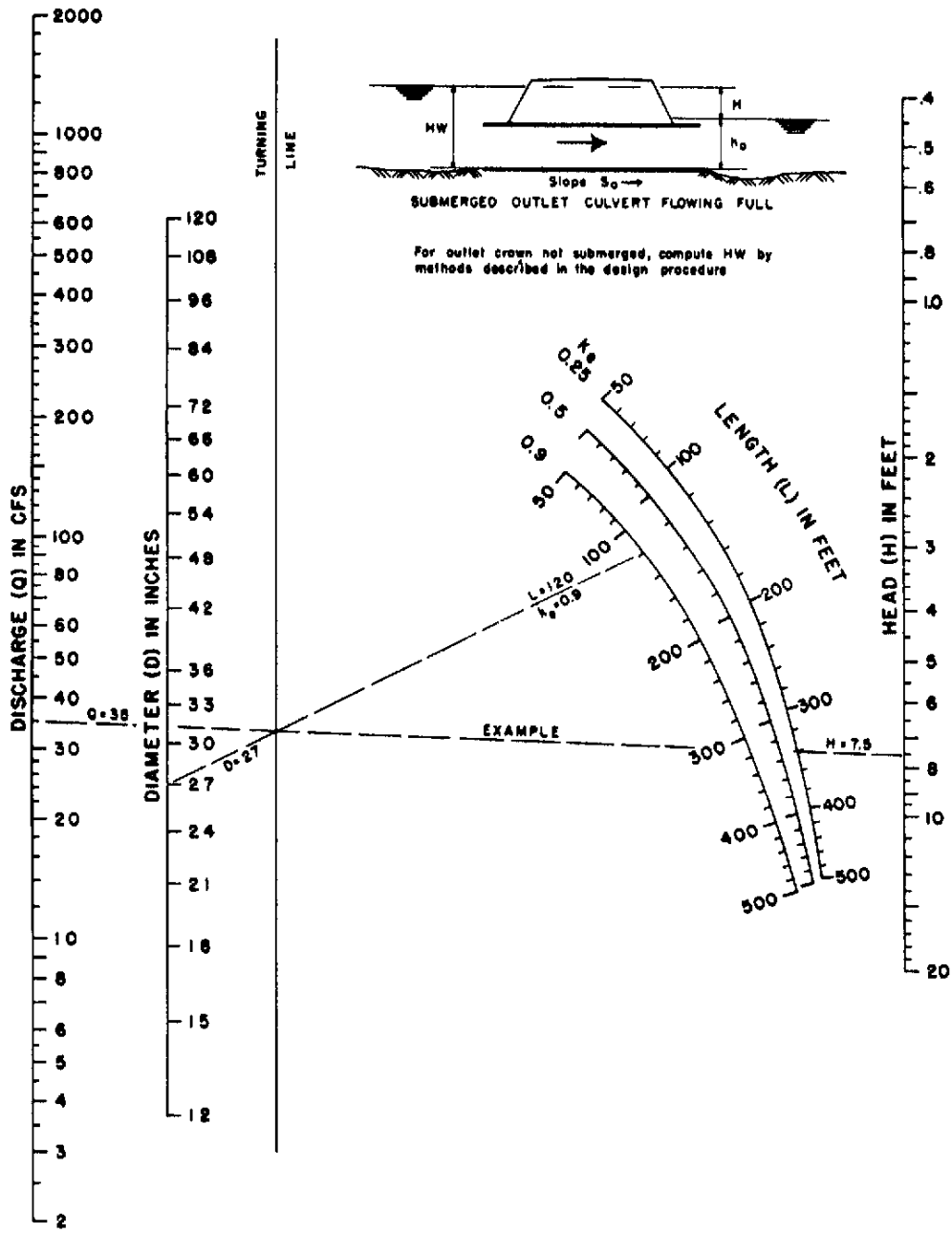
HEAD FOR  
CONCRETE PIPE CULVERTS  
FLOWING FULL  
 $n = 0.012$

BUREAU OF PUBLIC ROADS JAN. 1963

Source: HDS-5

Appendix 8C-6

Outlet Control,  
Circular Corrugated Metal



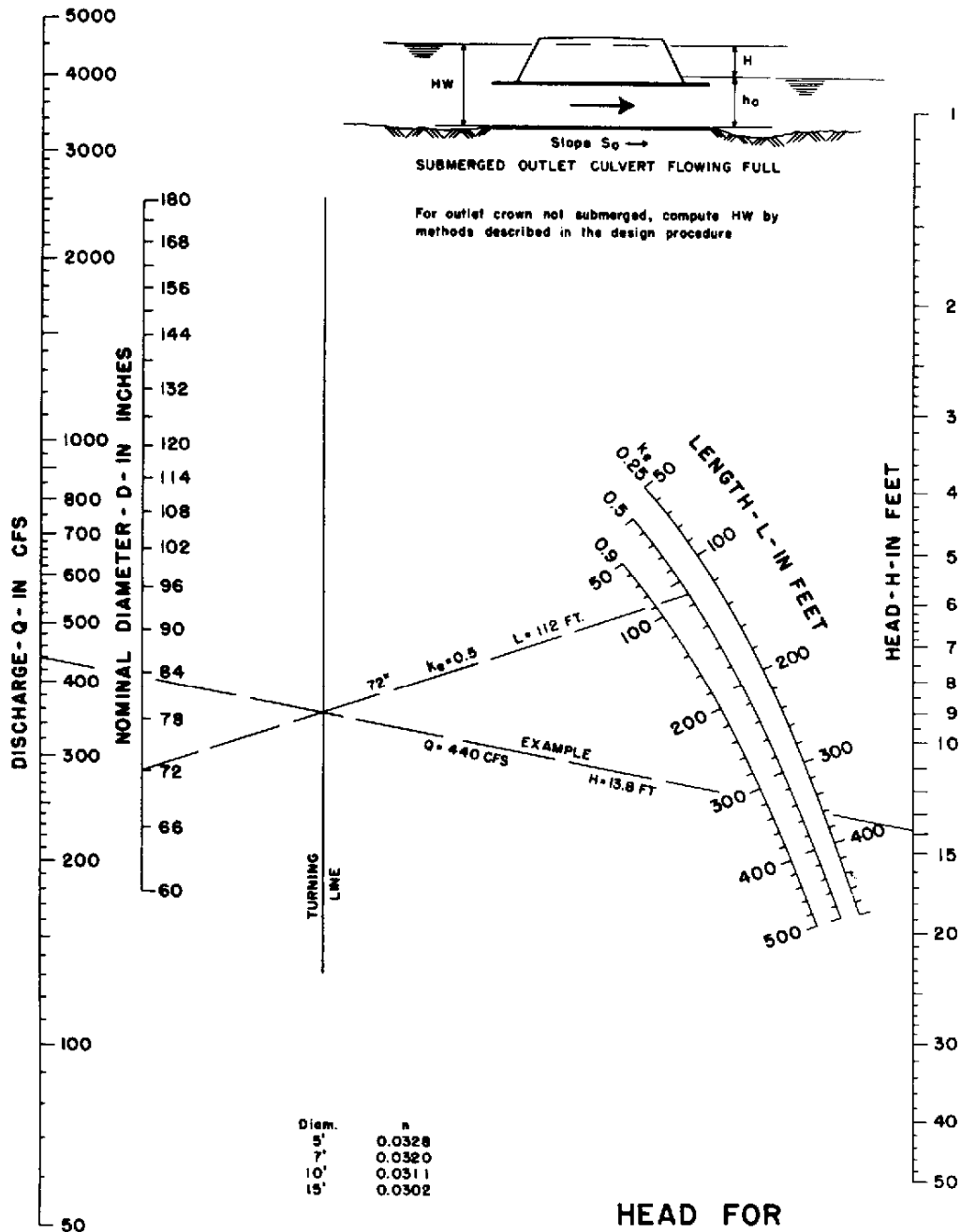
HEAD FOR  
STANDARD  
C. M. PIPE CULVERTS  
FLOWING FULL  
 $n = 0.024$

BUREAU OF PUBLIC ROADS JAN. 1963

Source: HDS-5

Appendix 8C-7

Outlet Control,  
Circular Structural Plate Corrugated Metal

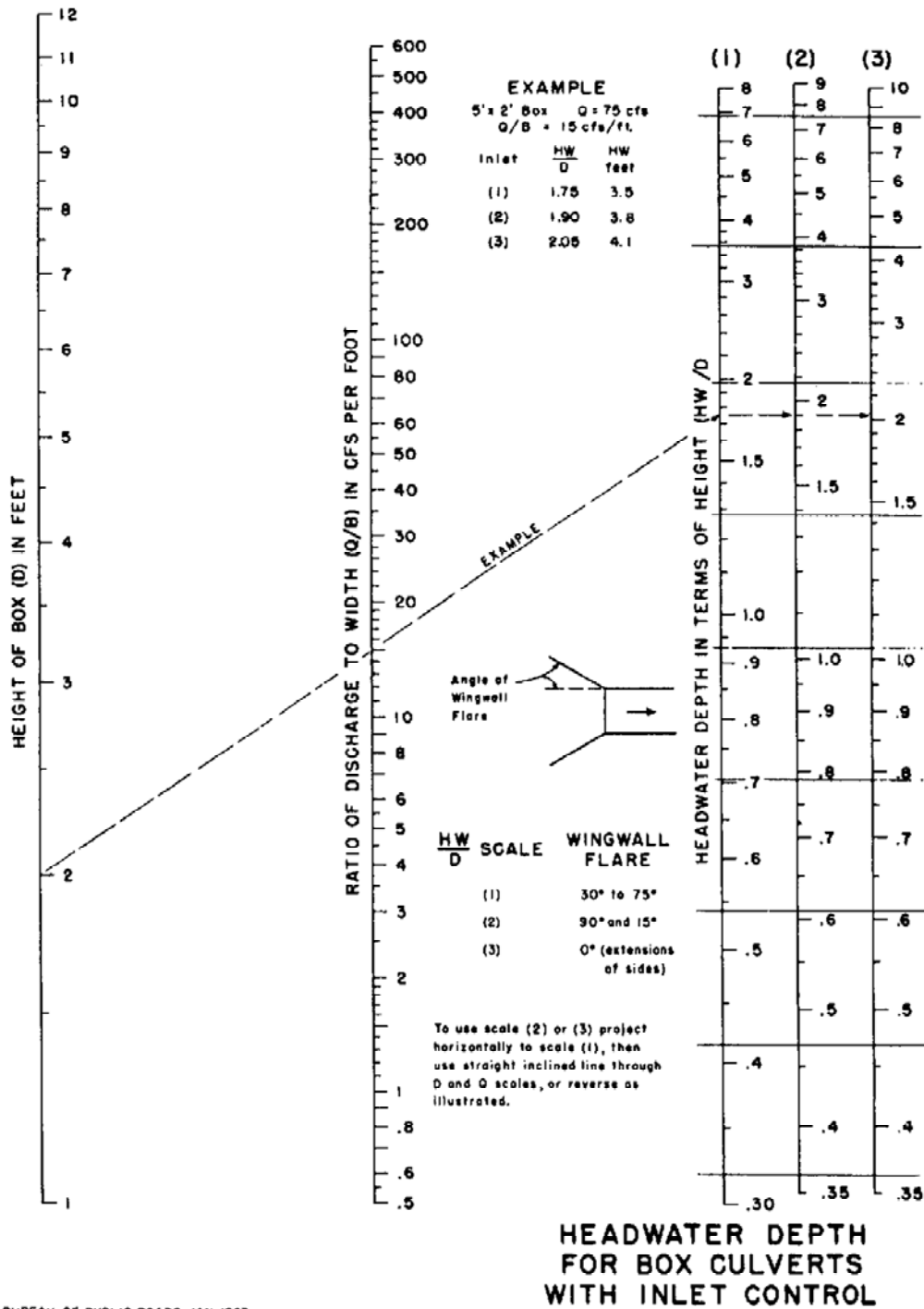


BUREAU OF PUBLIC ROADS JAN. 1963

Source: HDS-5

Appendix 8C-8

Inlet Control, Concrete Box

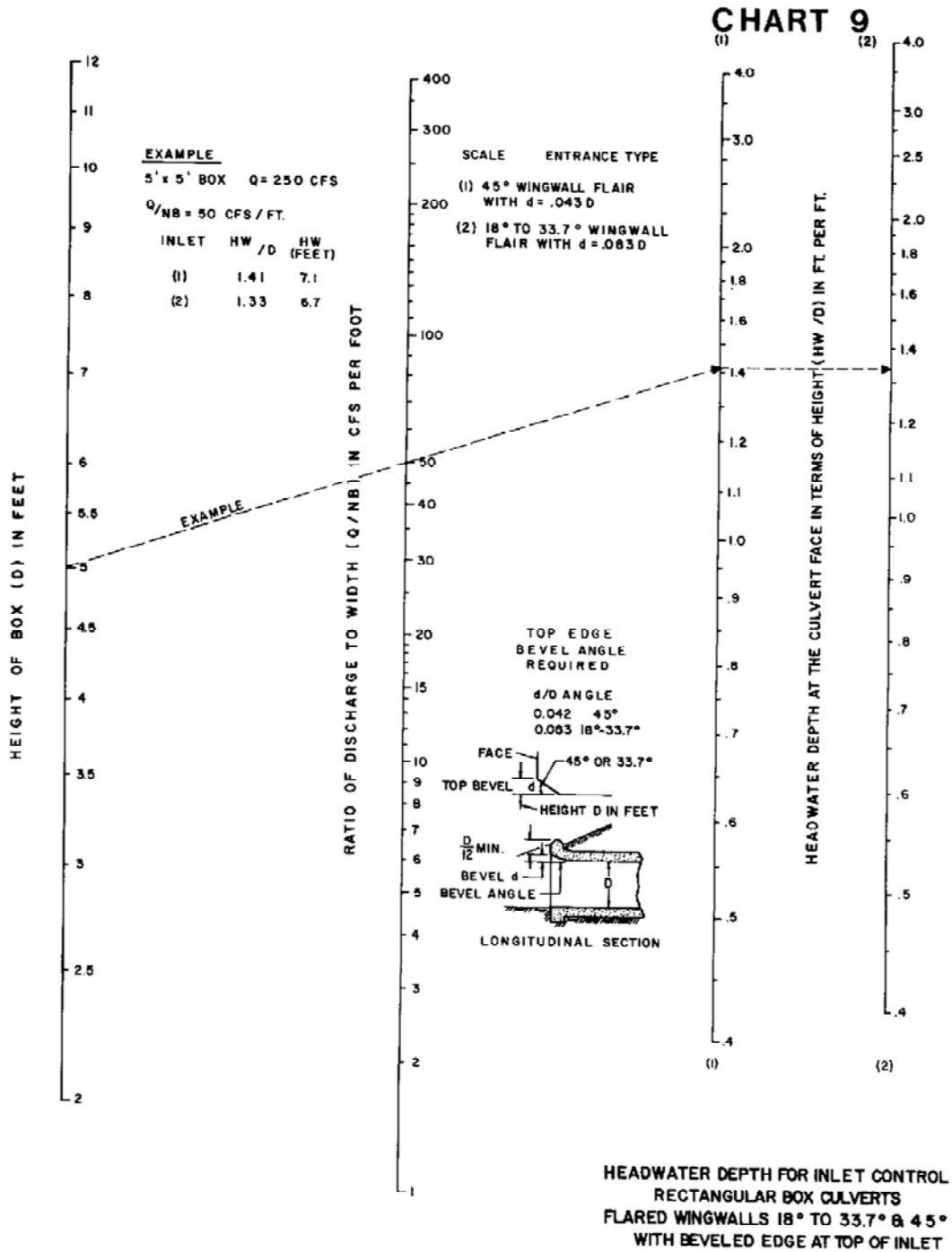


BUREAU OF PUBLIC ROADS JAN. 1963

Source: HDS-5

Appendix 8C-9

Inlet Control, Concrete Box,  
Flared Wingwalls at 18° to 33.7° and 45°,  
Beveled Top Edge



Source: HDS-5

Inlet Control, Concrete Box,  
90° Headwall,  
Chamfered or Beveled Edges

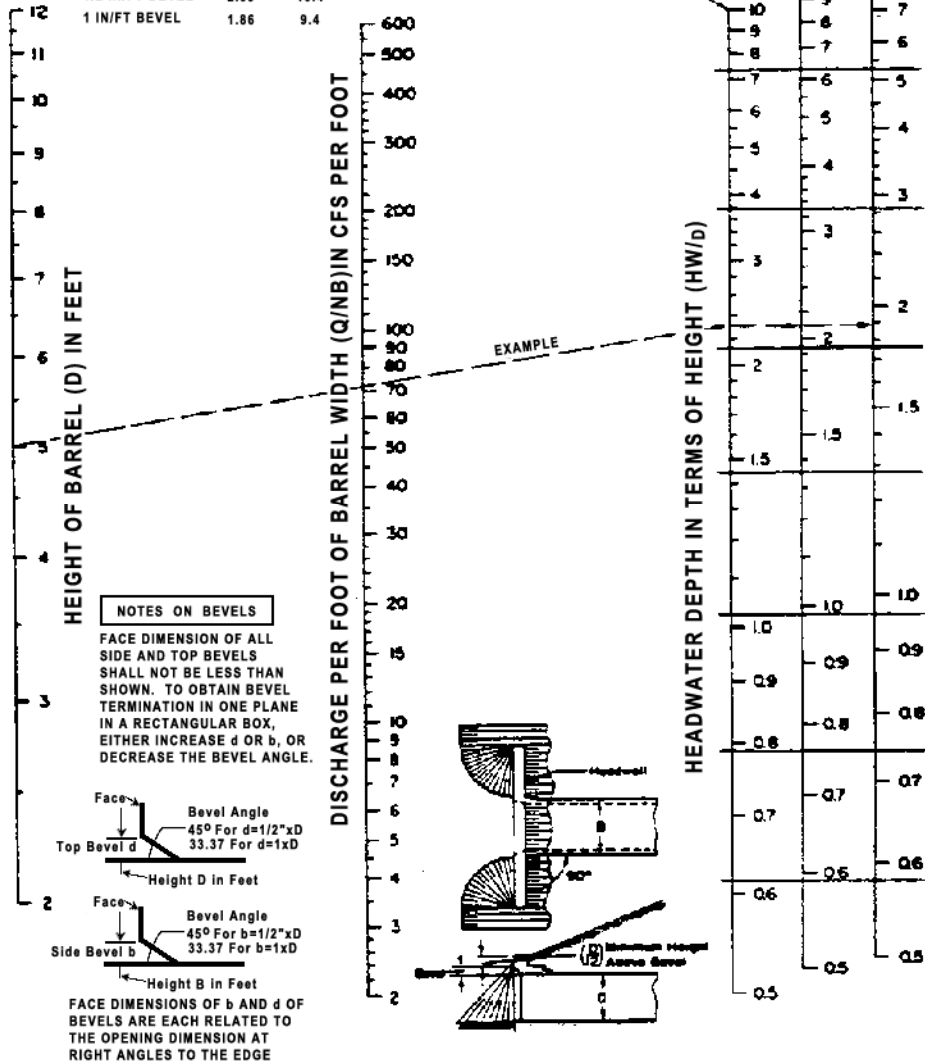


CHART 10

EXAMPLE  
8=7FT. D=5 FT. Q=500 CFS Q/NB=71.5

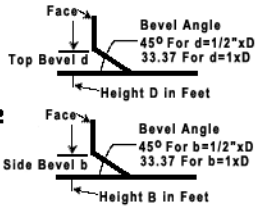
ALL EDGES	HW	HW
	0	feet
CHAMFER 3/4"	2.31	11.5
1/2 IN/FT BEVEL	2.09	10.4
1 IN/FT BEVEL	1.86	9.4

INLET FACE -- ALL EDGES:  
1IN/FT. BEVELS 33.7° (1:1.5)  
1/2 IN/FT. BEVELS 45° (1:1)  
3/4 INCH CHAMFERS



NOTES ON BEVELS

FACE DIMENSION OF ALL SIDE AND TOP BEVELS SHALL NOT BE LESS THAN SHOWN. TO OBTAIN BEVEL TERMINATION IN ONE PLANE IN A RECTANGULAR BOX, EITHER INCREASE d OR b, OR DECREASE THE BEVEL ANGLE.



FACE DIMENSIONS OF b AND d OF BEVELS ARE EACH RELATED TO THE OPENING DIMENSION AT RIGHT ANGLES TO THE EDGE

HEADWATER DEPTH FOR INLET CONTROL  
RECTANGULAR BOX CULVERTS  
90° HEADWALL  
CHAMFERED OR BEVELED INLET EDGES

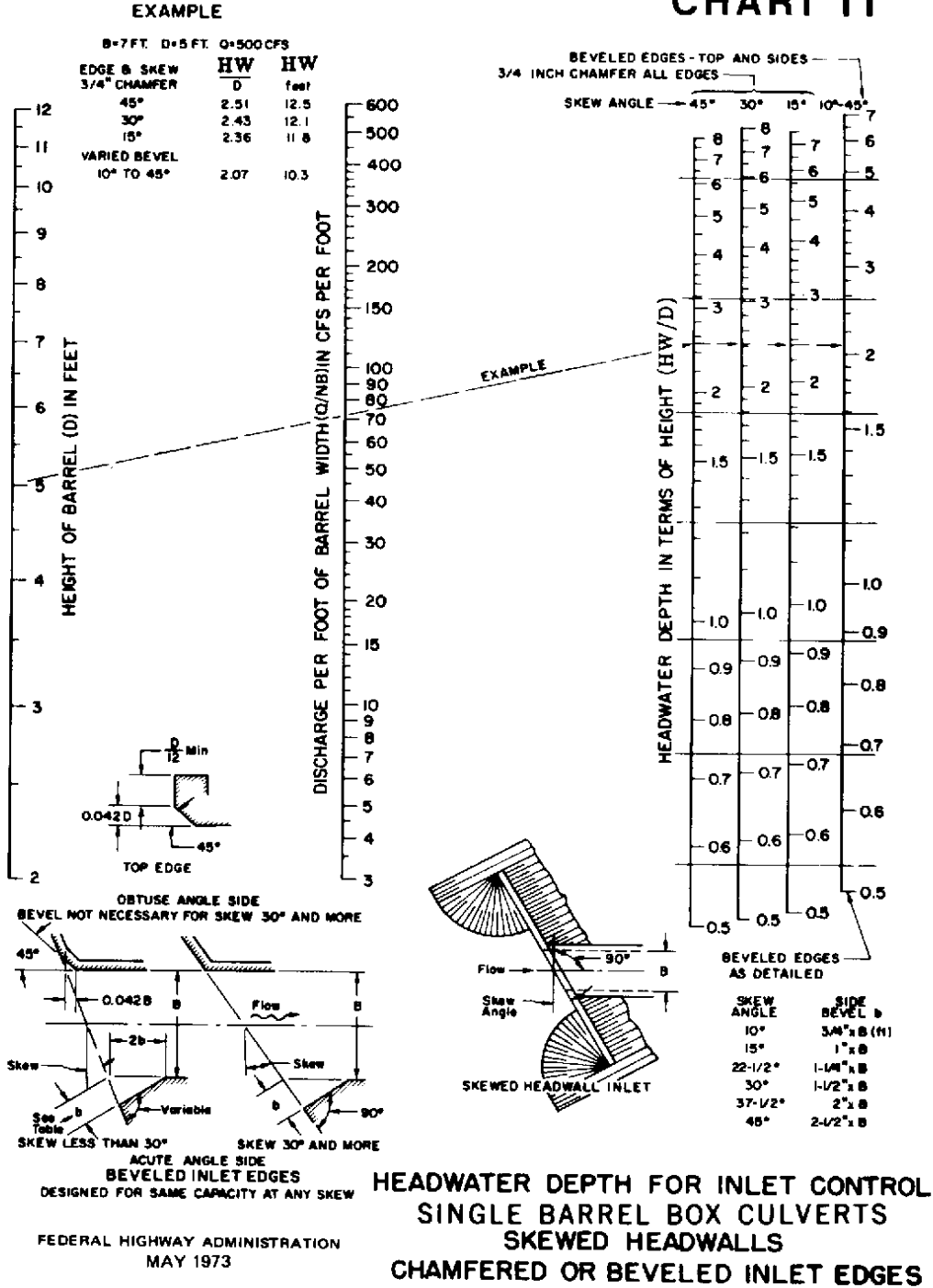
FEDERAL HIGHWAY ADMINISTRATION  
MAY 1973

Source: HDS-5

Appendix 8C-11

Inlet Control,  
Single Barrel Concrete Box,  
Skewed Headwalls Chamfered or Beveled Edges

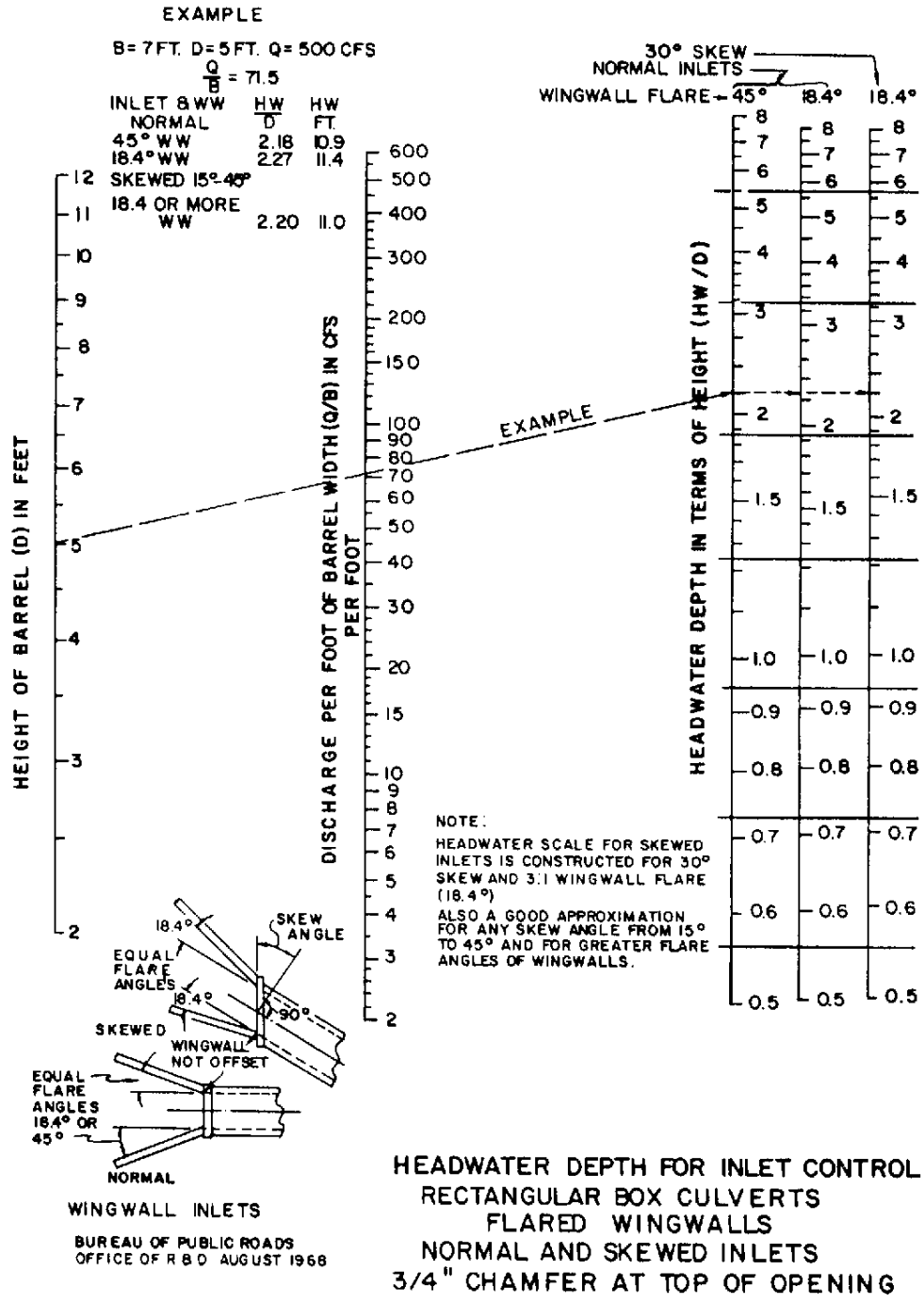
CHART 11



Source: HDS-5



Appendix 8C-12 Inlet Control, Concrete Box, Flared Wingwalls, Normal and Skewed Inlets, Chamfered Top Edge



Source: HDS-5

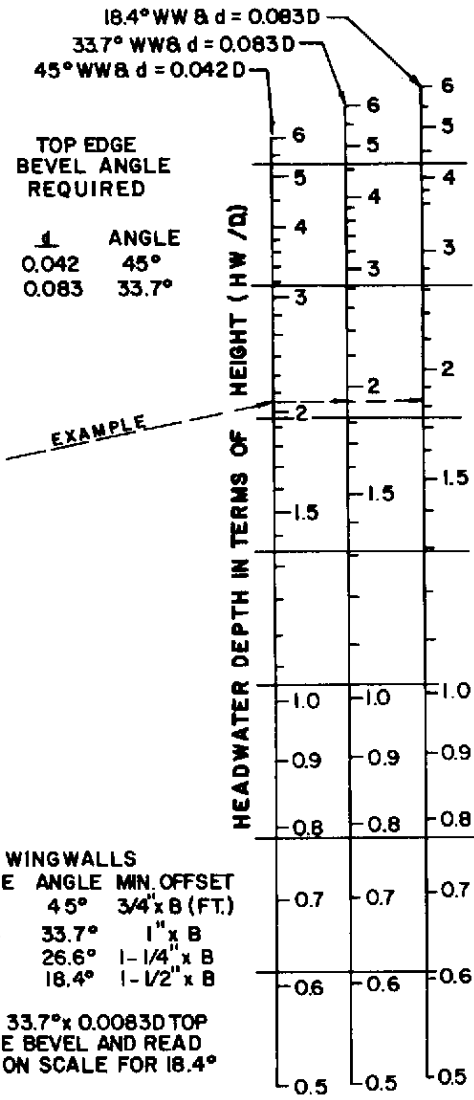
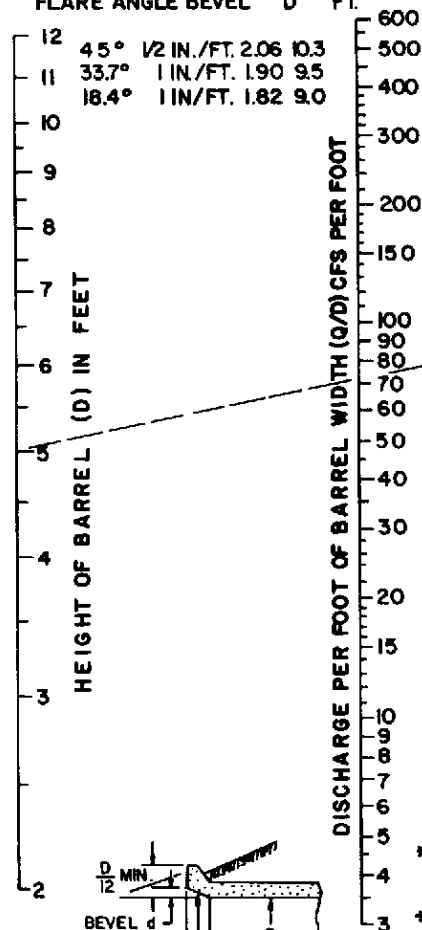
Appendix 8C-13 Inlet Control, Concrete Box with Offset Flared Wingwalls, Beveled Top Edge

CHART 13

EXAMPLE

B = 7 FT. D = 5 FT. Q = 600 C.F.S.  
 $\frac{Q}{B} = 71.5$

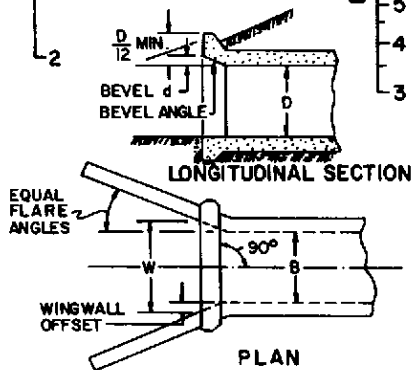
WINGWALL FLARE ANGLE	TOP EDGE BEVEL	HW / D	HW / Q
45°	1/2 IN./FT.	2.06	10.3
33.7°	1 IN./FT.	1.90	9.5
18.4°	1 IN./FT.	1.82	9.0



WINGWALLS

FLARE ANGLE	MIN. OFFSET
1:1 45°	3/4" x B (FT.)
1:1.5 33.7°	1" x B
* 1:2 26.6°	1-1/4" x B
1:3 18.4°	1-1/2" x B

\* USE 33.7° x 0.0083D TOP EDGE BEVEL AND READ HW ON SCALE FOR 18.4° WW

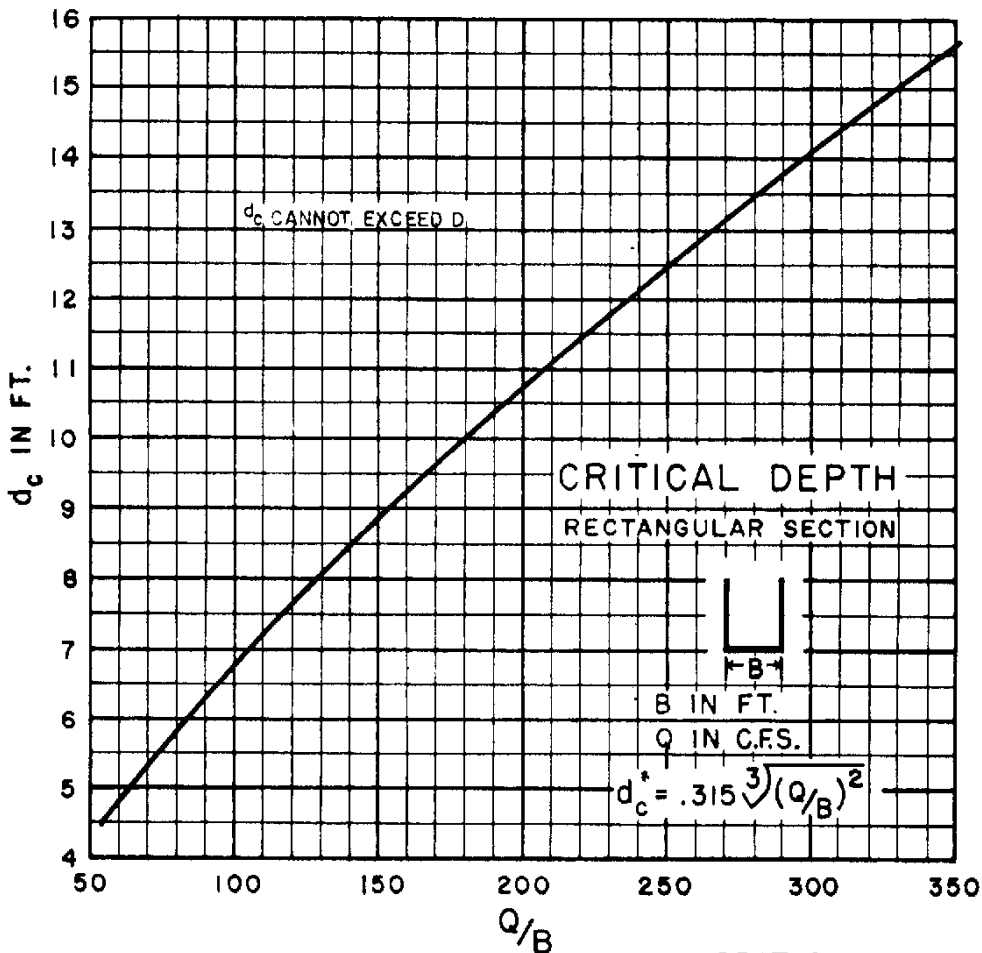
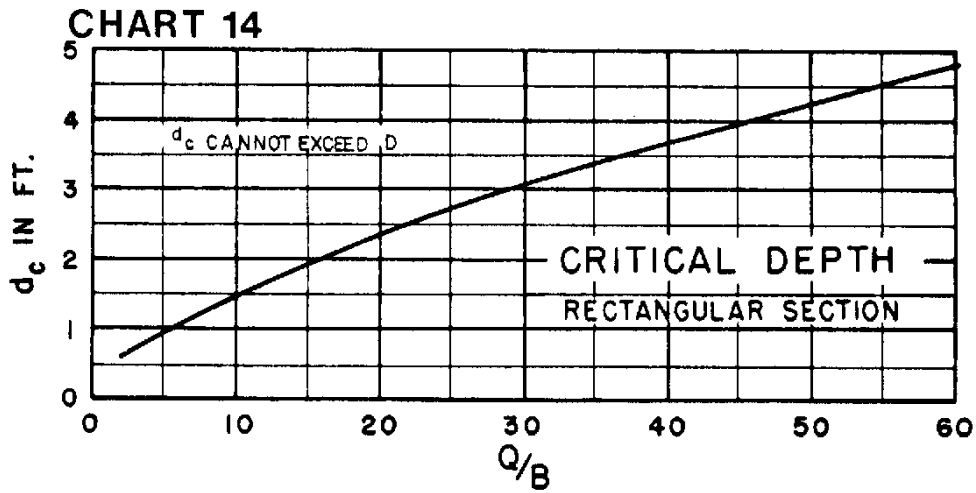


BUREAU OF PUBLIC ROADS  
 OFFICE OF R & D AUGUST 1968

HEADWATER DEPTH FOR INLET CONTROL  
 RECTANGULAR BOX CULVERTS  
 OFFSET FLARED WINGWALLS  
 AND BEVELED EDGE AT TOP OF INLET

Source: HDS-5

Appendix 8C-14 Critical Depth, Concrete Box

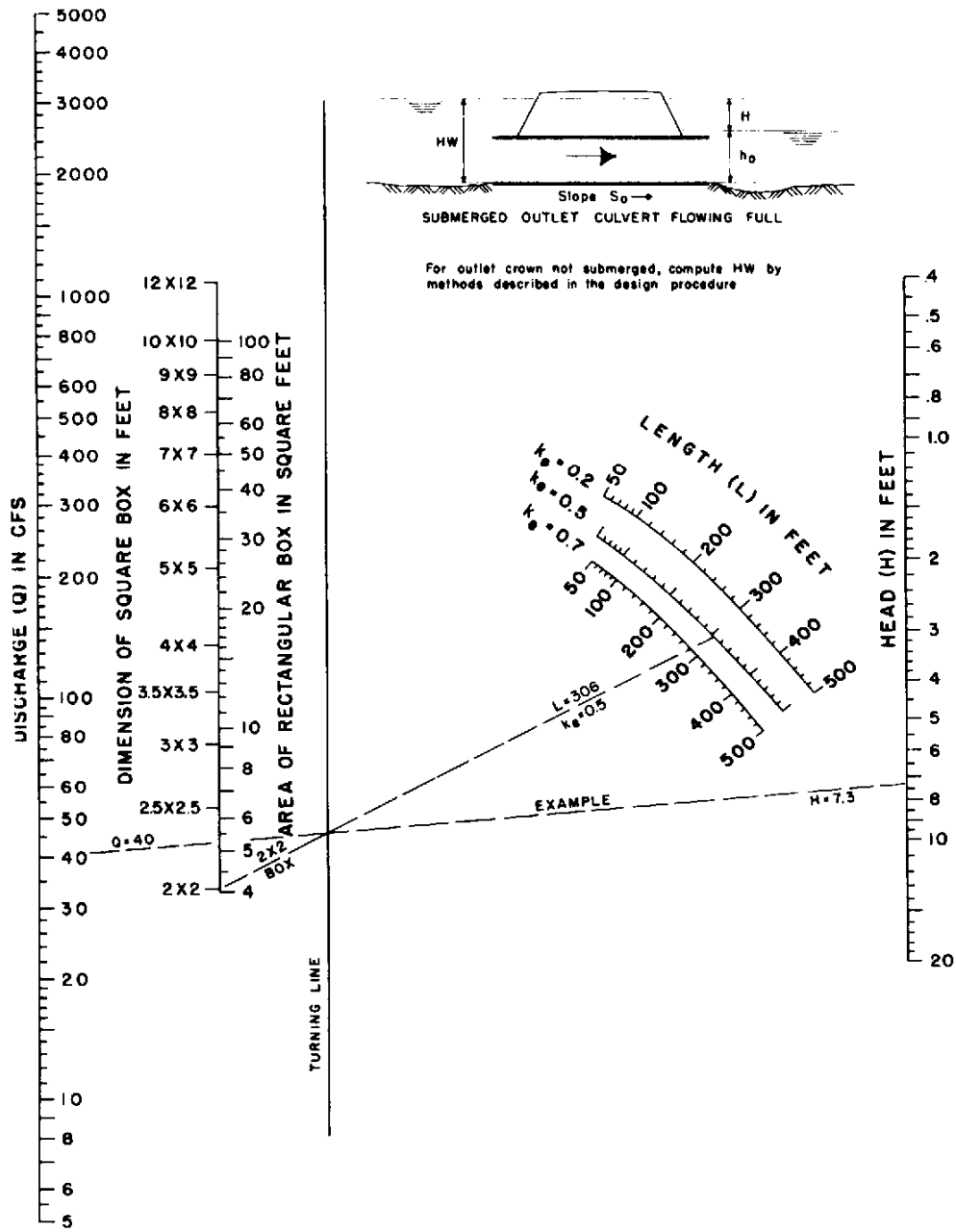


BUREAU OF PUBLIC ROADS JAN 1963

5-38

CRITICAL DEPTH  
RECTANGULAR SECTION

Source: HDS-5



**HEAD FOR  
CONCRETE BOX CULVERTS  
FLOWING FULL  
n = 0.012**

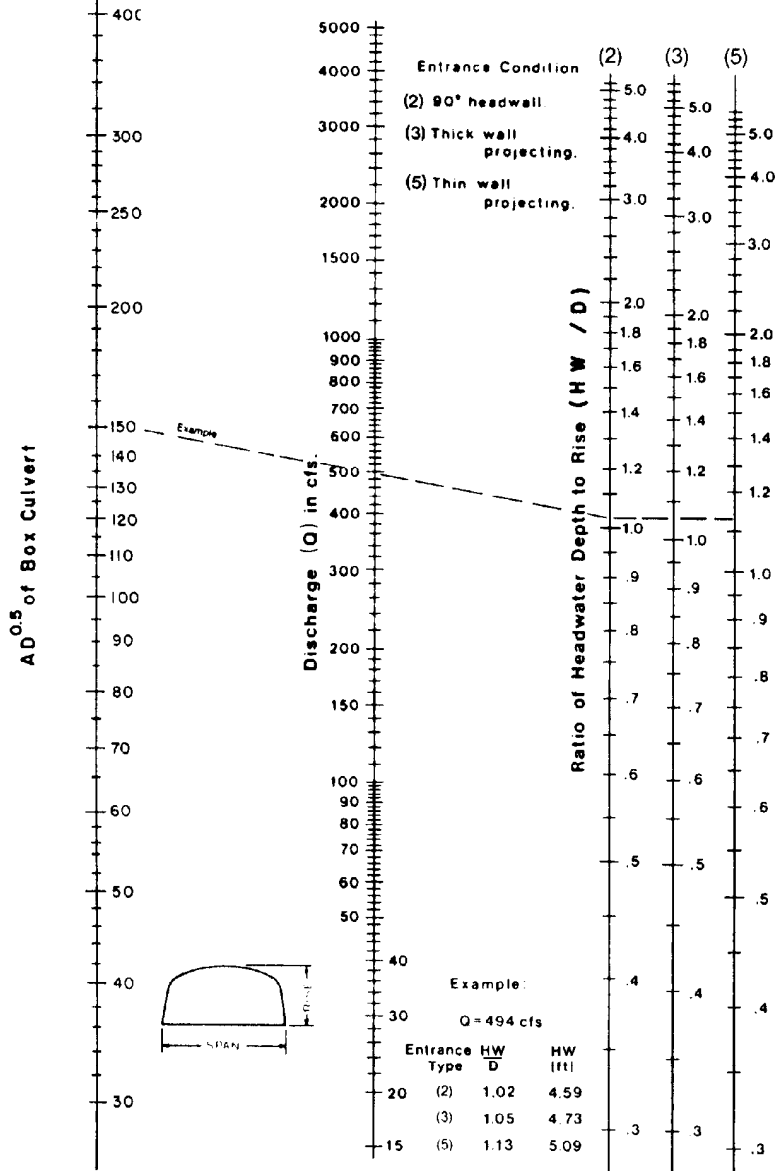
AU OF PUBLIC ROADS JAN. 1963

Source: HDS-5

Inlet Control,  
Corrugated Metal Box,  
Rise/Span < 0.3



CHART 16



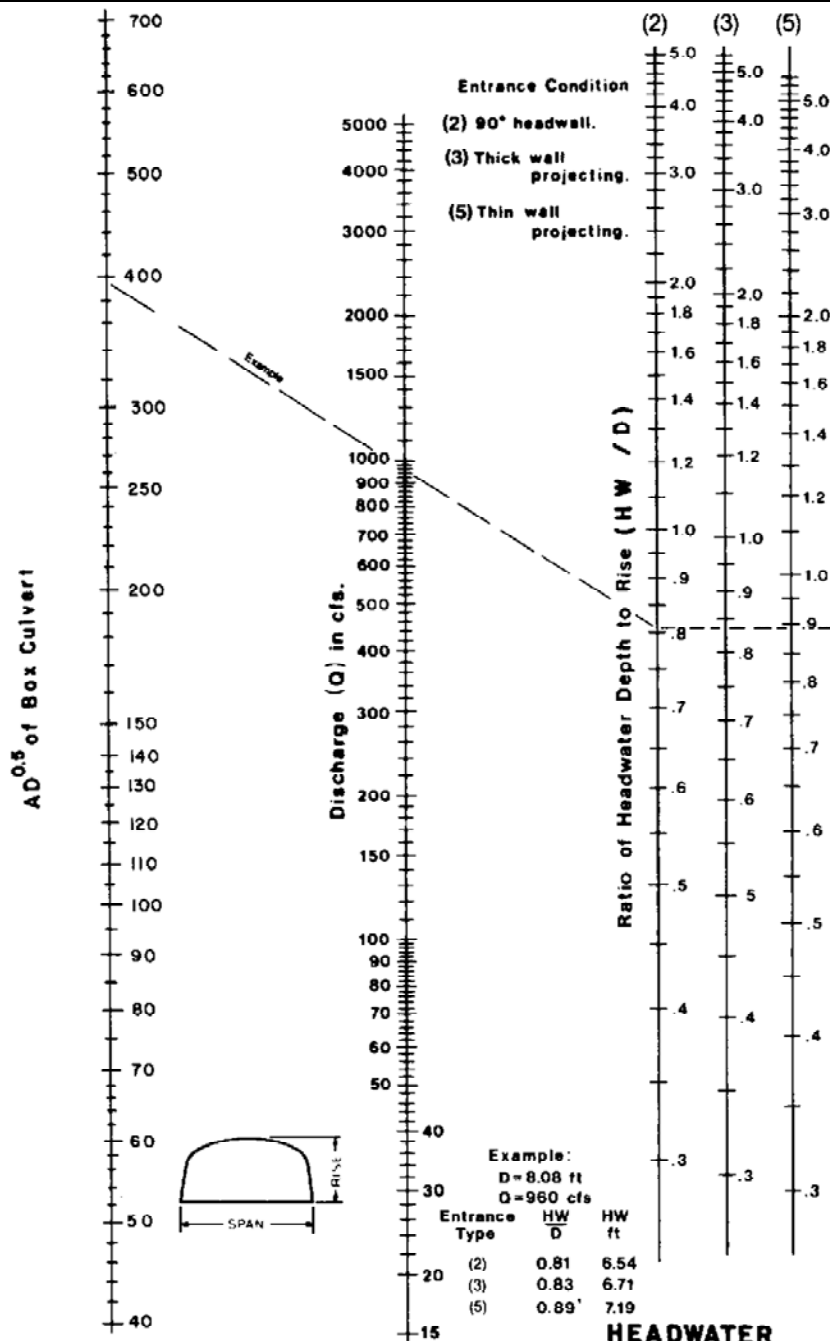
Nomographs adapted from material furnished by Kaiser Aluminum and Chemical Corporation

HEADWATER DEPTH  
FOR C.M. BOX CULVERTS  
RISE / SPAN < 0.3  
WITH INLET CONTROL

Source: HDS-5

Appendix 8C-17

Inlet Control,  
Corrugated Metal Box,  
 $0.3 \leq \text{Rise/Span} < 0.4$



Duplication of this nomograph may distort scale

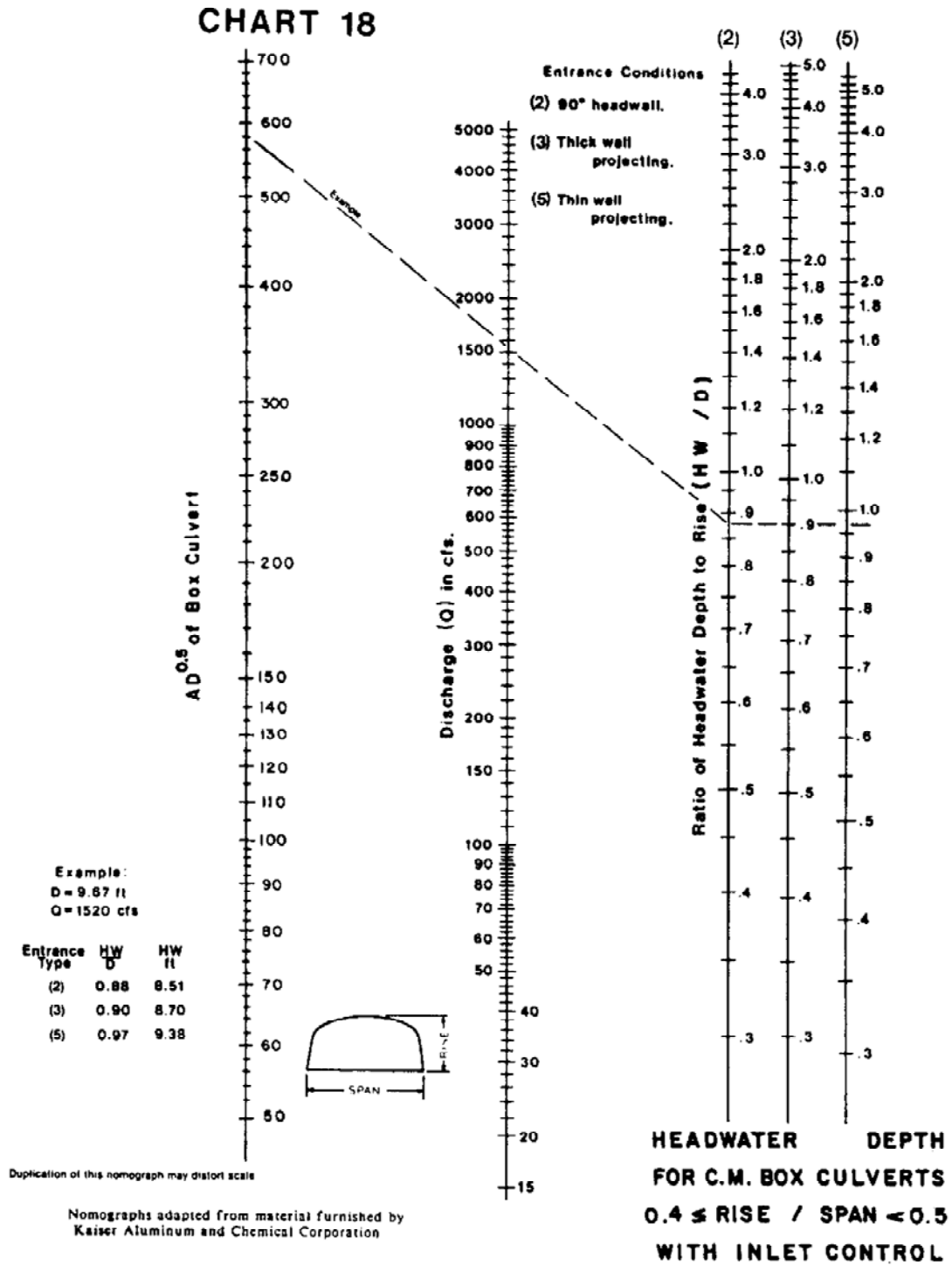
Nomographs adapted from material furnished by  
Kaiser Aluminum and Chemical Corporation

**HEADWATER DEPTH  
FOR C.M. BOX CULVERTS  
 $0.3 \leq \text{RISE} / \text{SPAN} < 0.4$   
WITH INLET CONTROL**

Source: HDS-5

Appendix 8C-18

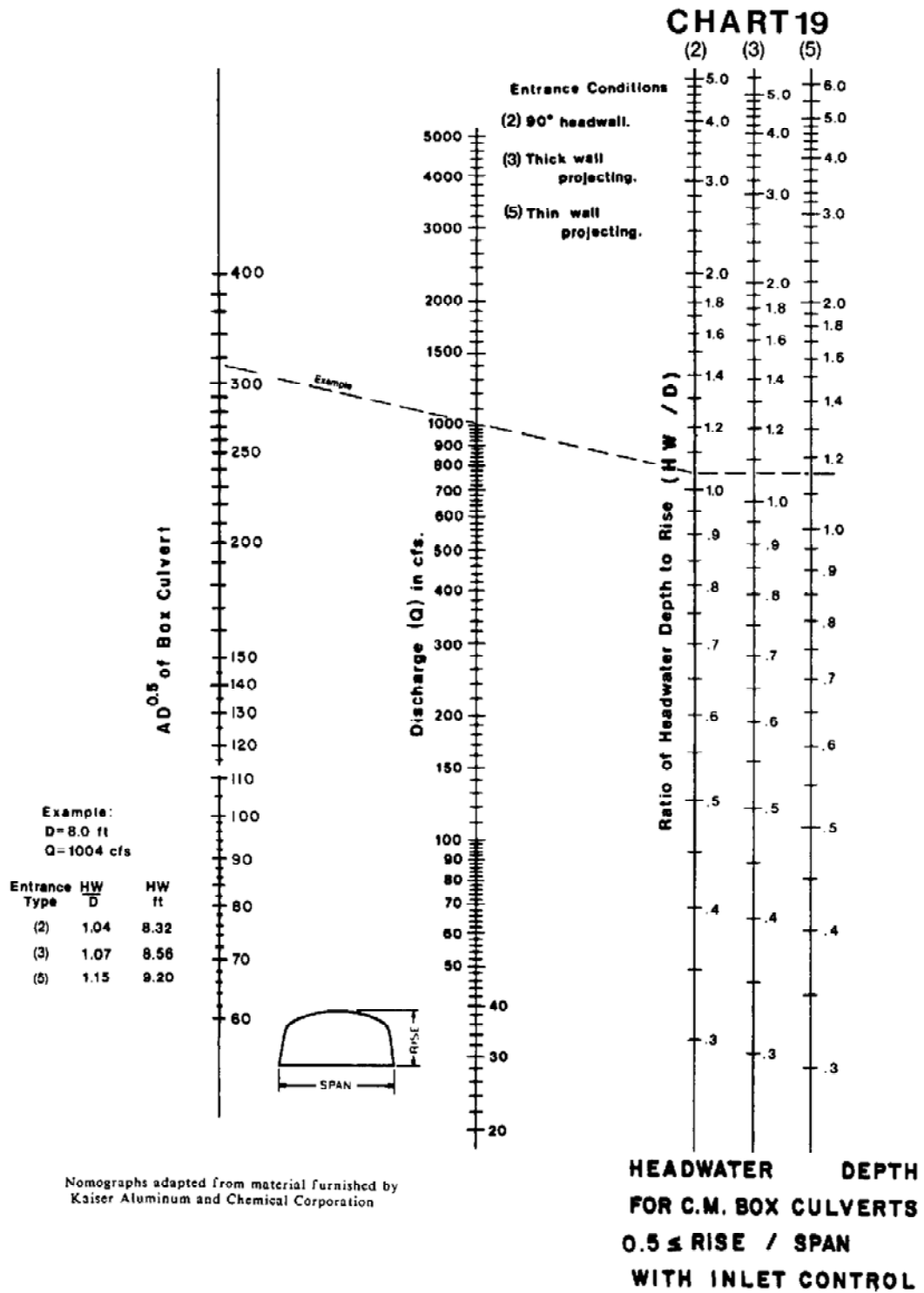
Inlet Control,  
Corrugated Metal Box,  
 $0.4 \leq \text{Rise/Span} < 0.5$



Source: HDS-5

Appendix 8C-19

Inlet Control,  
Corrugated Metal Box,  
 $0.5 \leq \text{Rise/Span}$

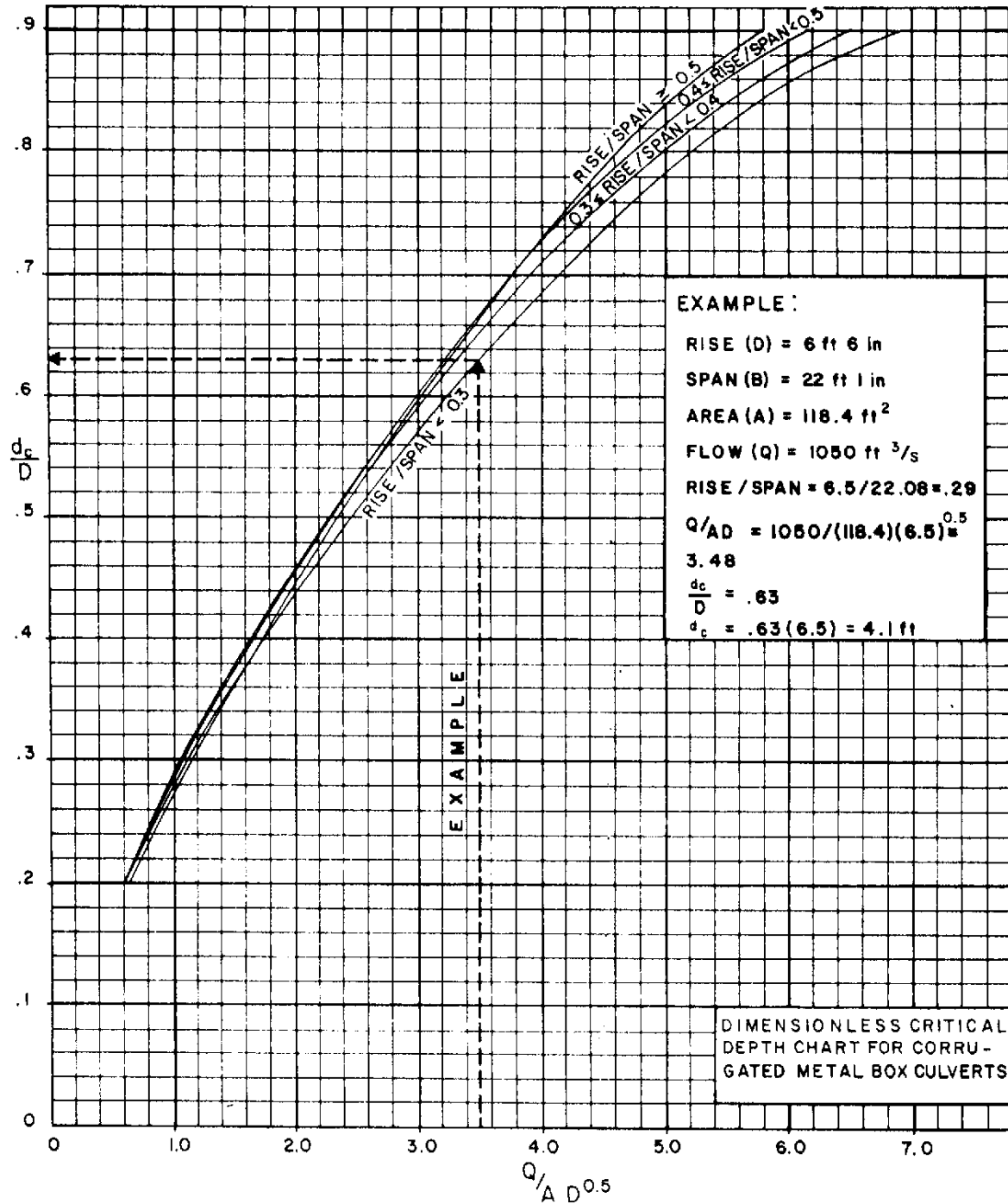


Source: HDS-5



Appendix 8C-20 Critical Depth, Corrugated Metal Box

CHART 20

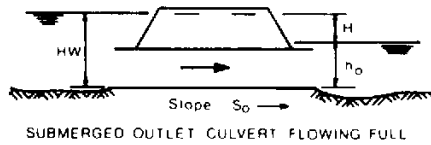
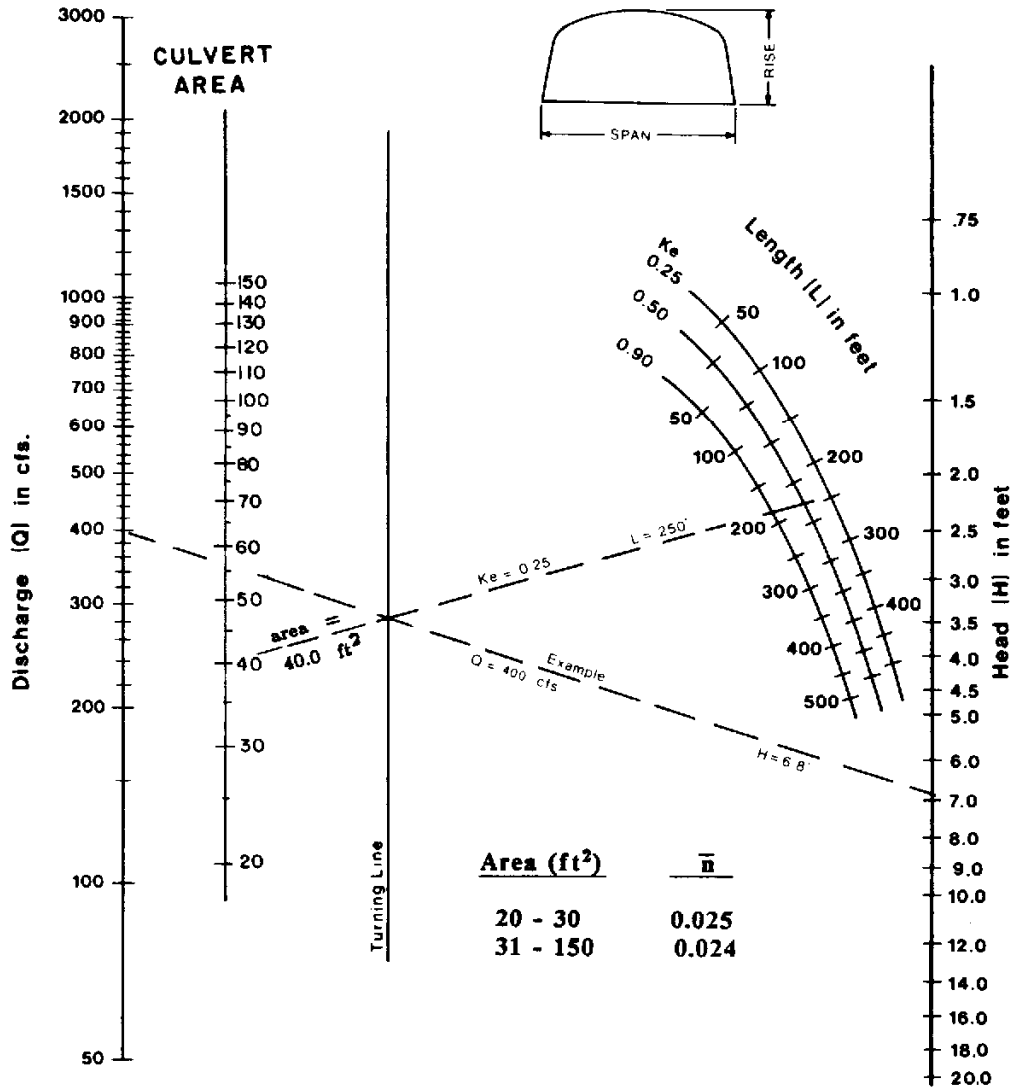


Source: HDS-5

Appendix 8C-21

Outlet Control,  
Corrugated Metal Box, Concrete Bottom  
Rise/Span < 0.3

CHART 21



HEAD FOR  
C. M. BOX CULVERTS  
FLOWING FULL  
CONCRETE BOTTOM  
RISE / SPAN < 0.3

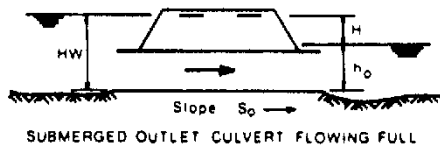
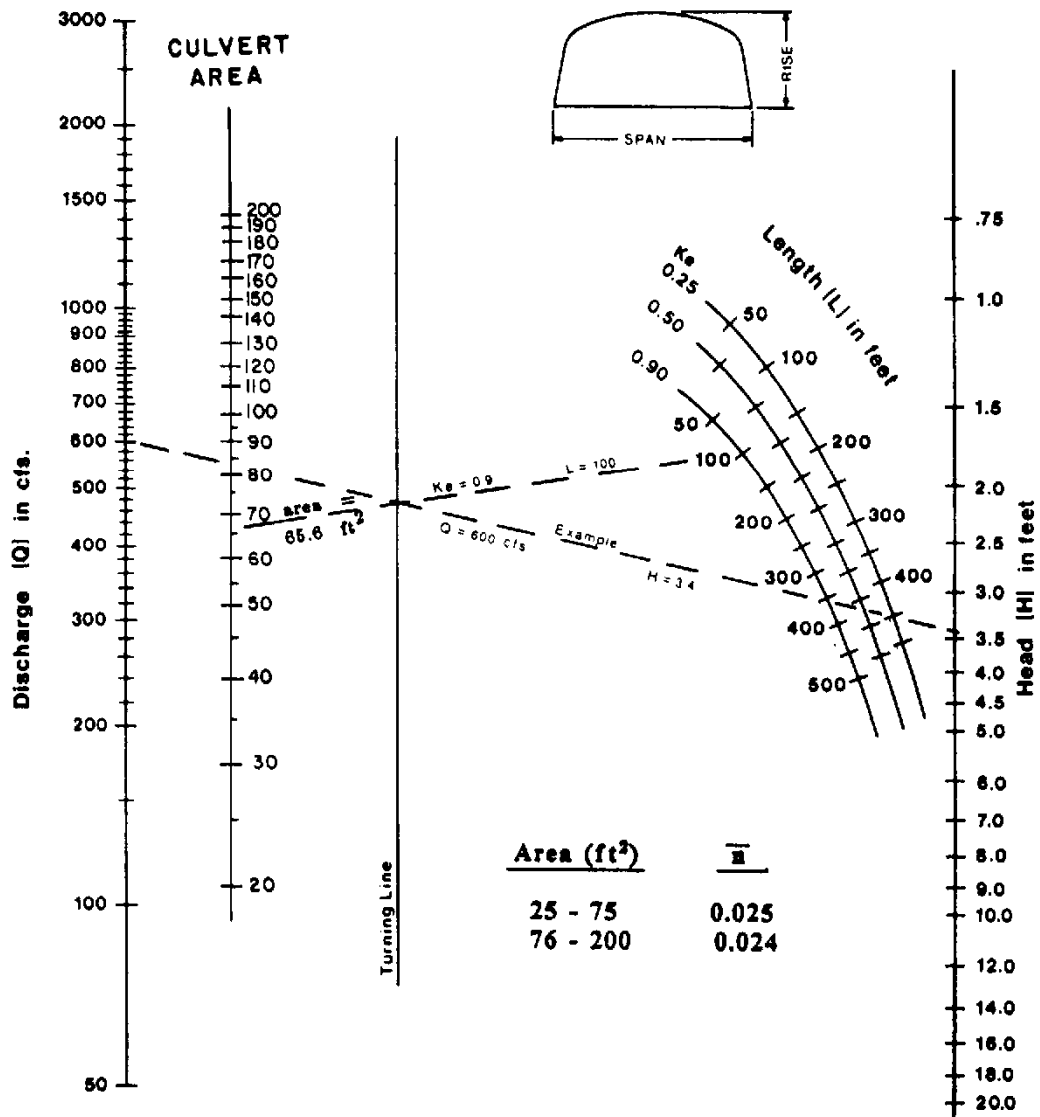
Nomographs adapted from material furnished by  
Kaiser Aluminum and Chemical Corporation

Duplication of this nomograph may distort scale

Source: HDS-3

Appendix 8C-22

Outlet Control,  
Corrugated Metal Box, Concrete Bottom  
 $0.3 \leq \text{Rise/Span} < 0.4$



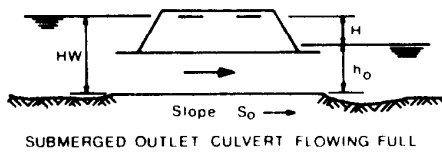
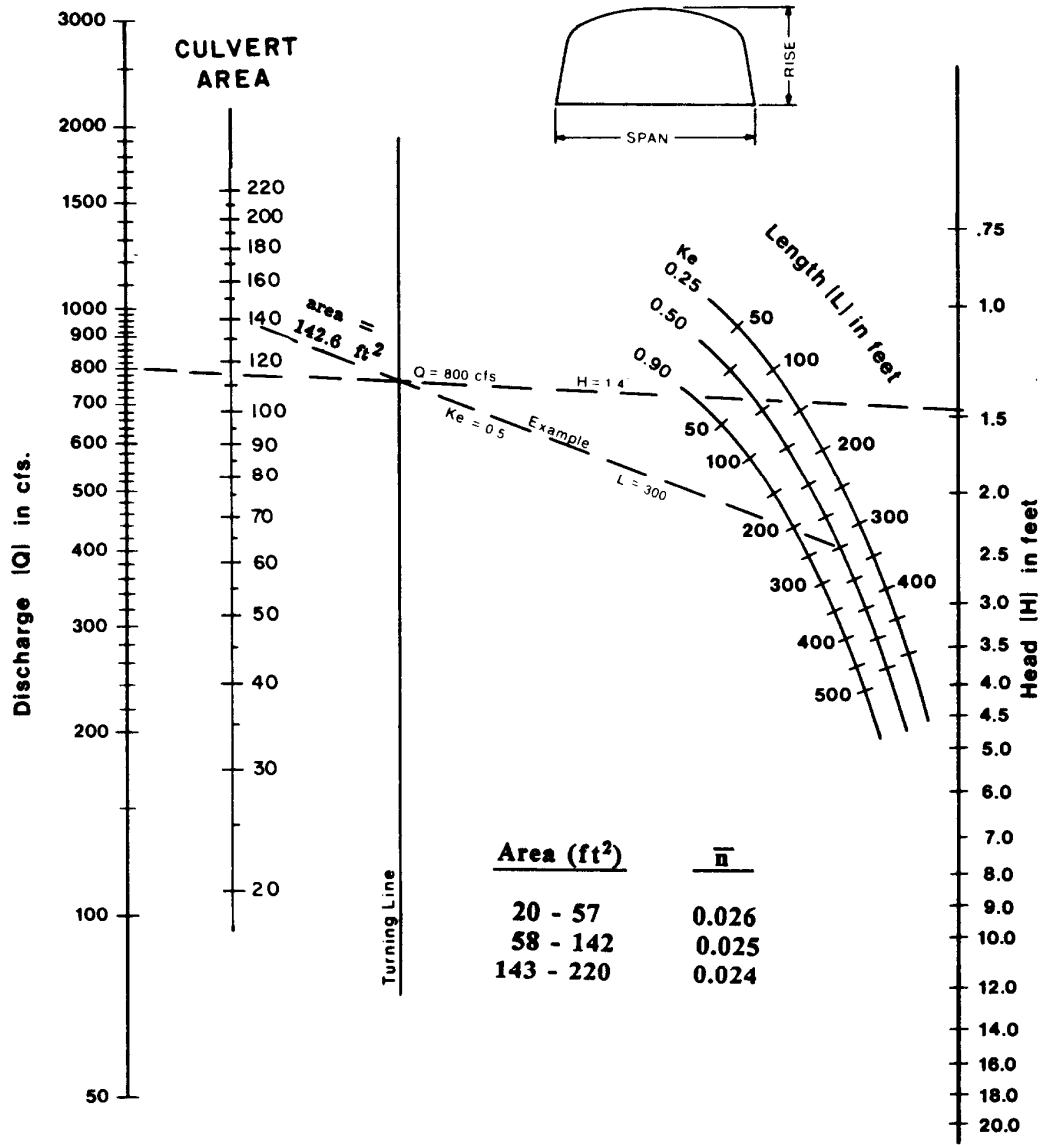
**HEAD FOR  
C. M. BOX CULVERTS  
FLOWING FULL  
CONCRETE BOTTOM  
 $0.3 \leq \text{RISE/SPAN} < 0.4$**

Nomographs adapted from material furnished by  
Kaiser Aluminum and Chemical Corporation

Duplication of this nomograph may distort scale

Source: HDS-5

Appendix 8C-23 Outlet Control, Corrugated Metal Box, Concrete Bottom,  $0.4 \leq \text{Rise/Span} < 0.5$



**HEAD FOR  
C. M. BOX CULVERTS  
FLOWING FULL  
CONCRETE BOTTOM  
 $0.4 \leq \text{RISE / SPAN} < 0.5$**

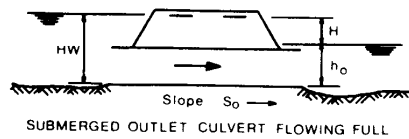
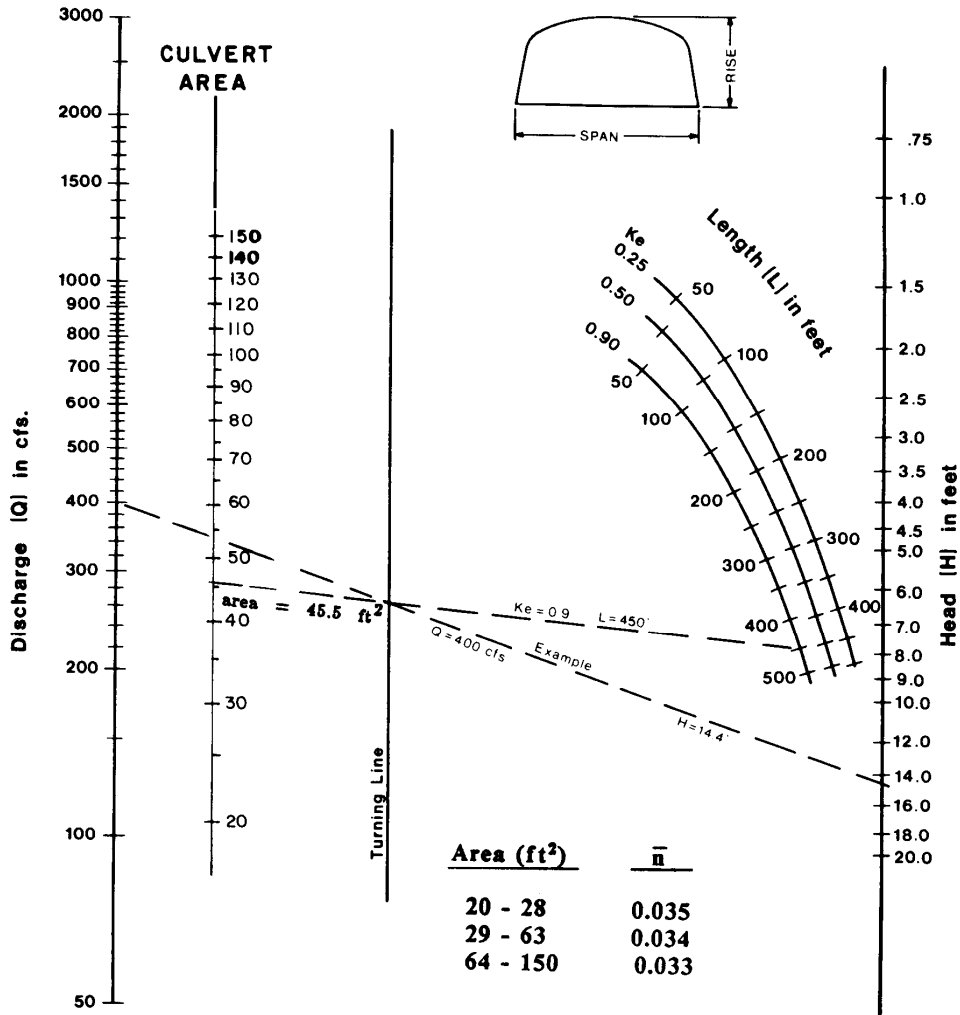
Nomographs adapted from material furnished by Kaiser Aluminum and Chemical Corporation

Duplication of this nomograph may distort scale

Source: HDS-5

Appendix 8C-25 Outlet Control, Corrugated Metal Box,  
Corrugated Metal Bottom,  
Rise/Span < 0.3

CHART 25



**HEAD FOR  
C. M. BOX CULVERTS  
FLOWING FULL  
CORRUGATED METAL BOTTOM  
RISE / SPAN < 0.3**

Nomographs adapted from material furnished by  
Kaiser Aluminum and Chemical Corporation

Duplication of this nomograph may distort scale

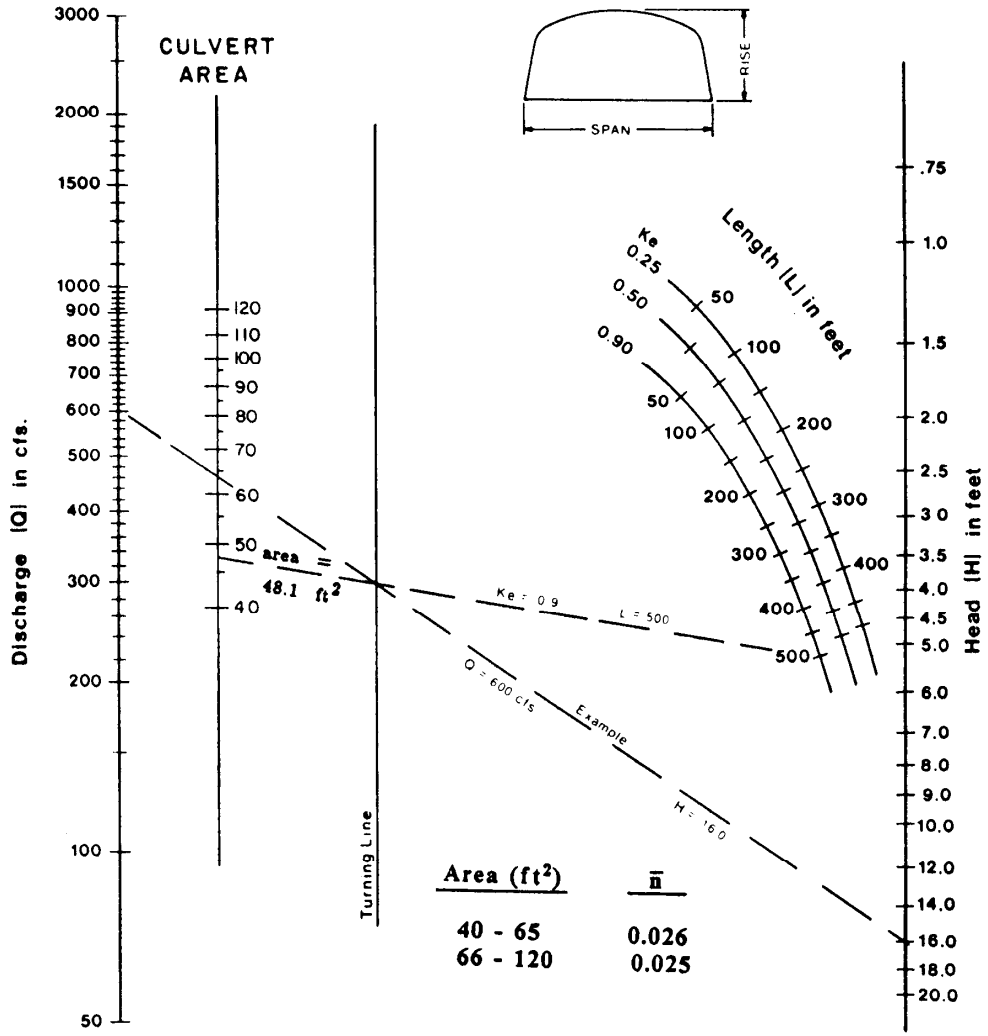
Source: HDS-5

Appendix 8C-24

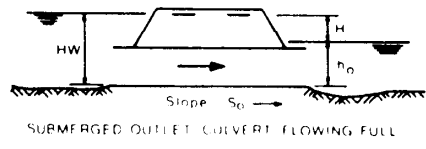
Outlet Control,  
Corrugated Metal Box, Concrete Bottom  
 $0.5 \leq \text{Rise/Span}$



CHART 24



Area (ft <sup>2</sup> )	$\bar{n}$
40 - 65	0.026
66 - 120	0.025



**HEAD FOR  
C. M. BOX CULVERTS  
FLOWING FULL  
CONCRETE BOTTOM  
 $0.5 \leq \text{RISE / SPAN}$**

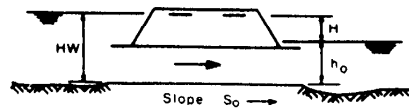
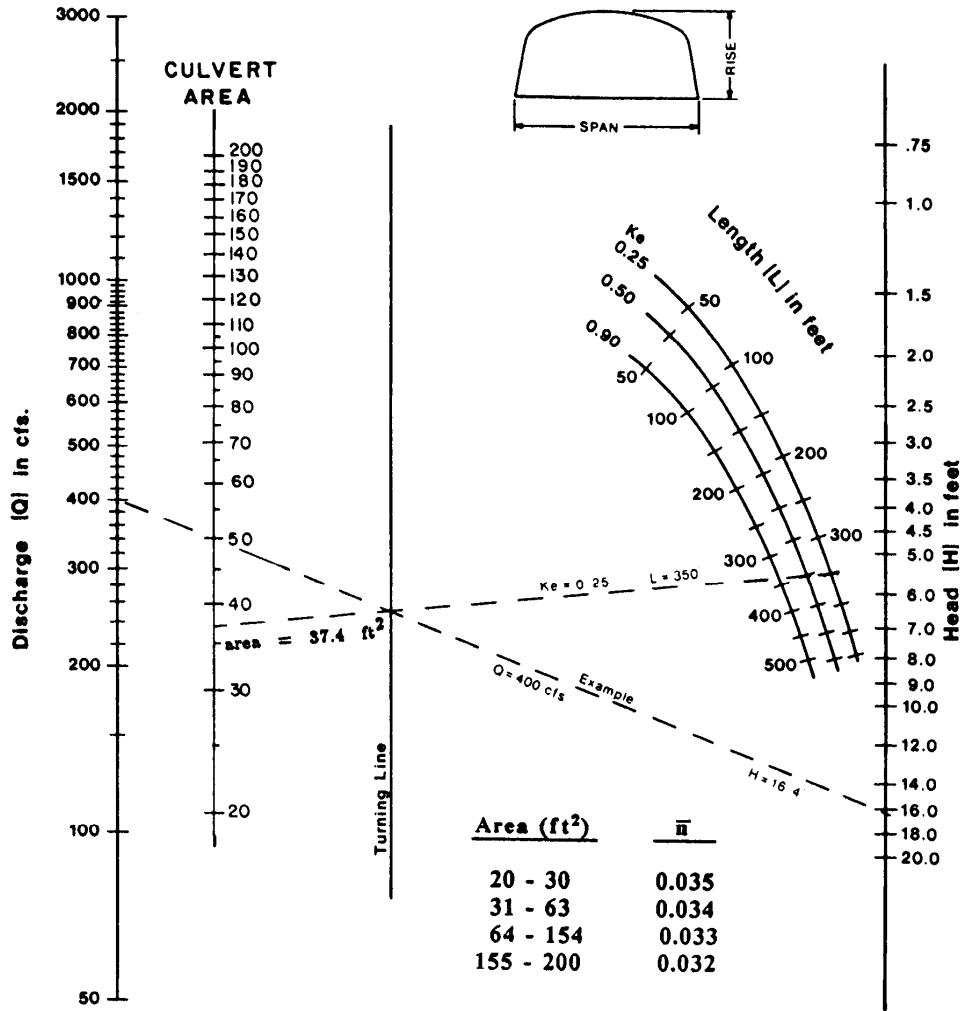
Nomographs adapted from material furnished by  
Kaiser Aluminum and Chemical Corporation  
Duplication of this nomograph may distort scale

Source: HDS-5

Appendix 8C-26 Outlet Control, Corrugated Metal Box,  
Corrugated Metal Box,  
 $0.3 \leq \text{Rise/SPAN} < 0.4$



CHART 26



SUBMERGED OUTLET CULVERT FLOWING FULL

**HEAD FOR  
C. M. BOX CULVERTS  
FLOWING FULL  
CORRUGATED METAL BOTTOM  
 $0.3 \leq \text{RISE / SPAN} < 0.4$**

Nomographs adapted from material furnished by  
Kaiser Aluminum and Chemical Corporation

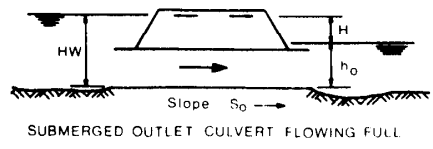
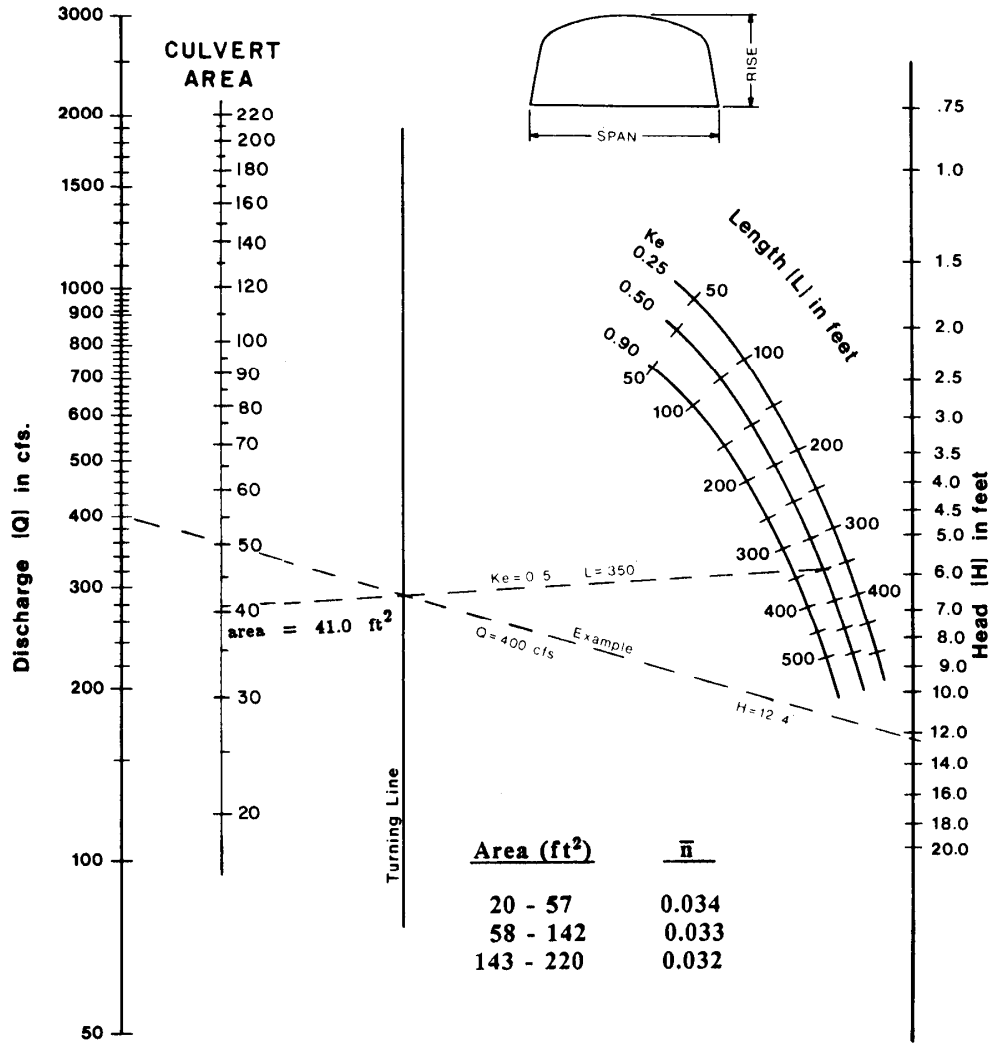
Duplication of this nomograph may distort scale

Source: HDS-5

Appendix 8C-27 Outlet Control, Corrugated Metal Box,  
Corrugated Metal Bottom,  
 $0.4 \leq \text{Rise/SPAN} < 0.5$



CHART 27



**HEAD FOR  
C. M. BOX CULVERTS  
FLOWING FULL  
CORRUGATED METAL BOTTOM  
 $0.4 \leq \text{RISE / SPAN} < 0.5$**

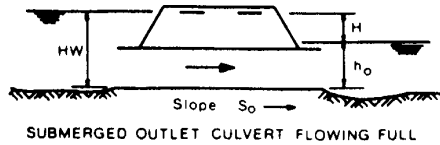
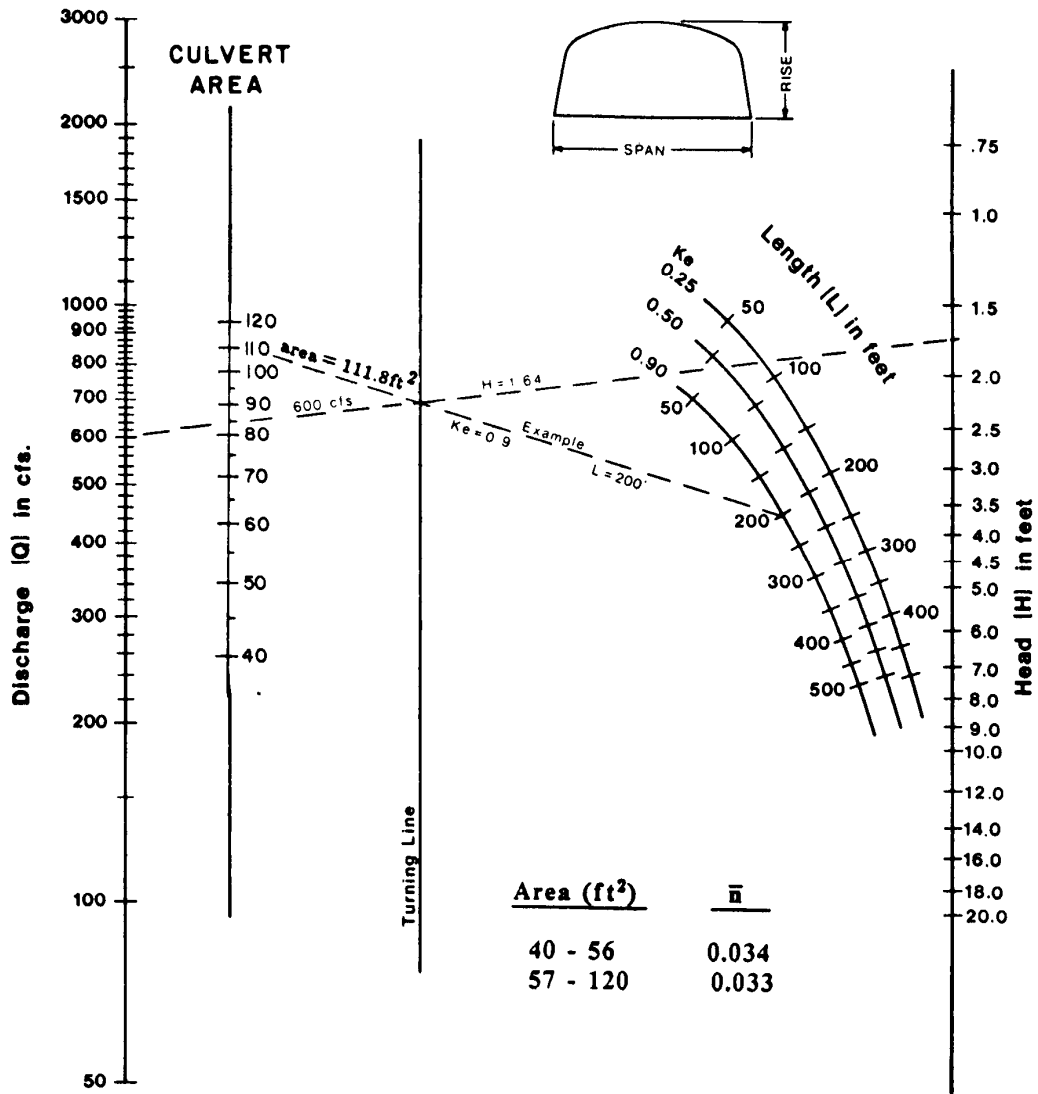
Nomographs adapted from material furnished by  
Kaiser Aluminum and Chemical Corporation

Duplication of this nomograph may distort scale

Source: HDS-5



Appendix 8C-28 Outlet Control, Corrugated Metal Box,  
Corrugated Metal Bottom,  
 $0.5 \leq \text{Rise/Span}$



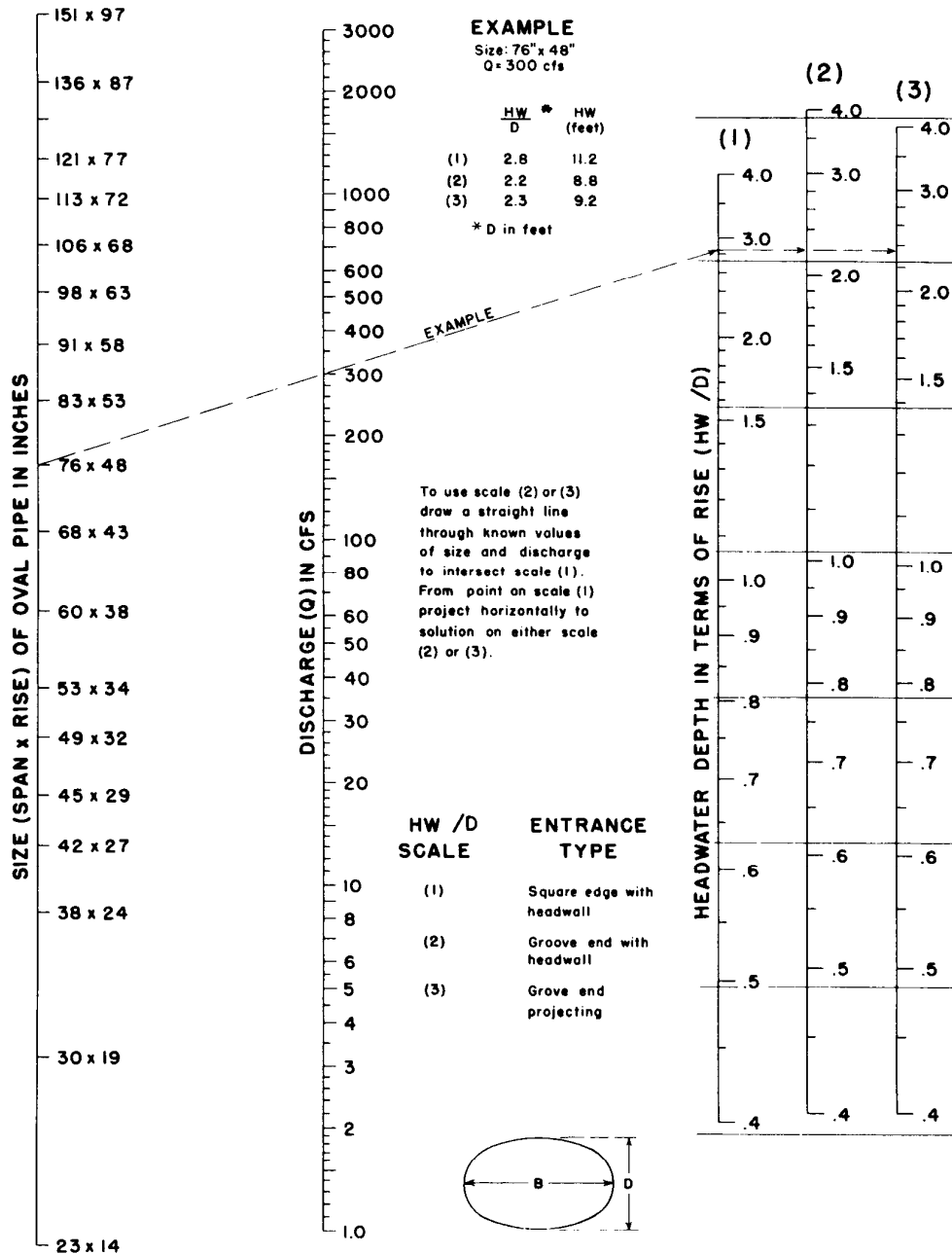
HEAD FOR  
C. M. BOX CULVERTS  
FLOWING FULL  
CORRUGATED METAL BOTTOM  
 $0.5 \leq \text{RISE/SPAN}$

Nomographs adapted from material furnished by  
Kaiser Aluminum and Chemical Corporation

Duplication of this nomograph may distort scale

Source: HDS-5

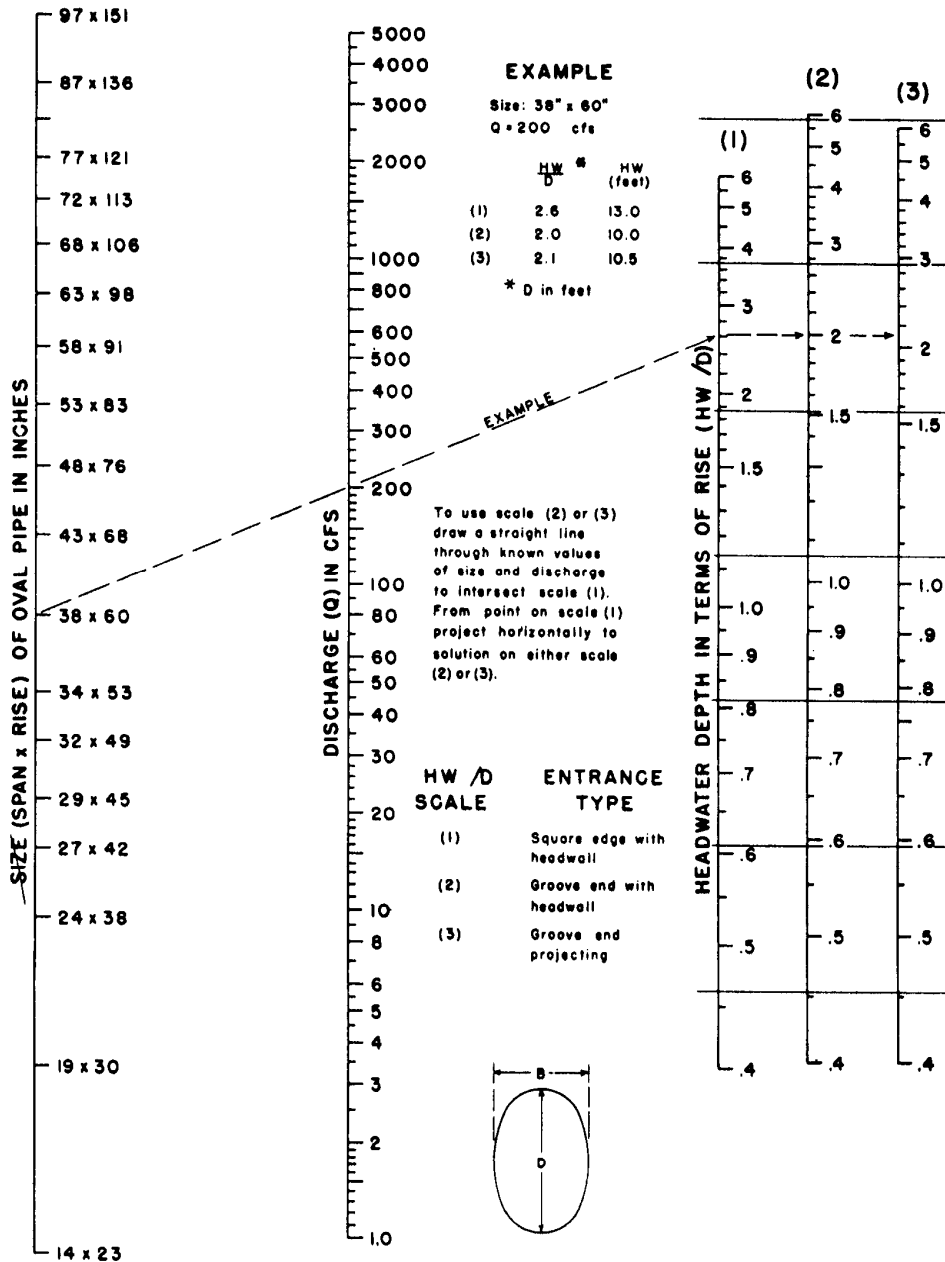
Inlet Control, Oval Concrete,  
Long Axis Horizontal



HEADWATER DEPTH FOR  
OVAL CONCRETE PIPE CULVERTS  
LONG AXIS HORIZONTAL  
WITH INLET CONTROL

BUREAU OF PUBLIC ROADS JAN. 1963

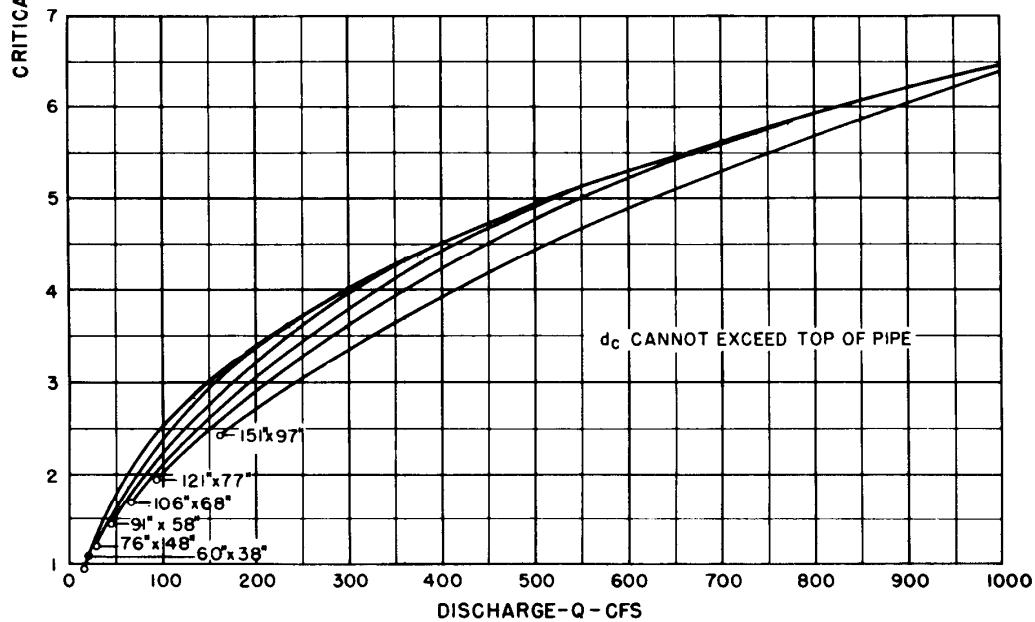
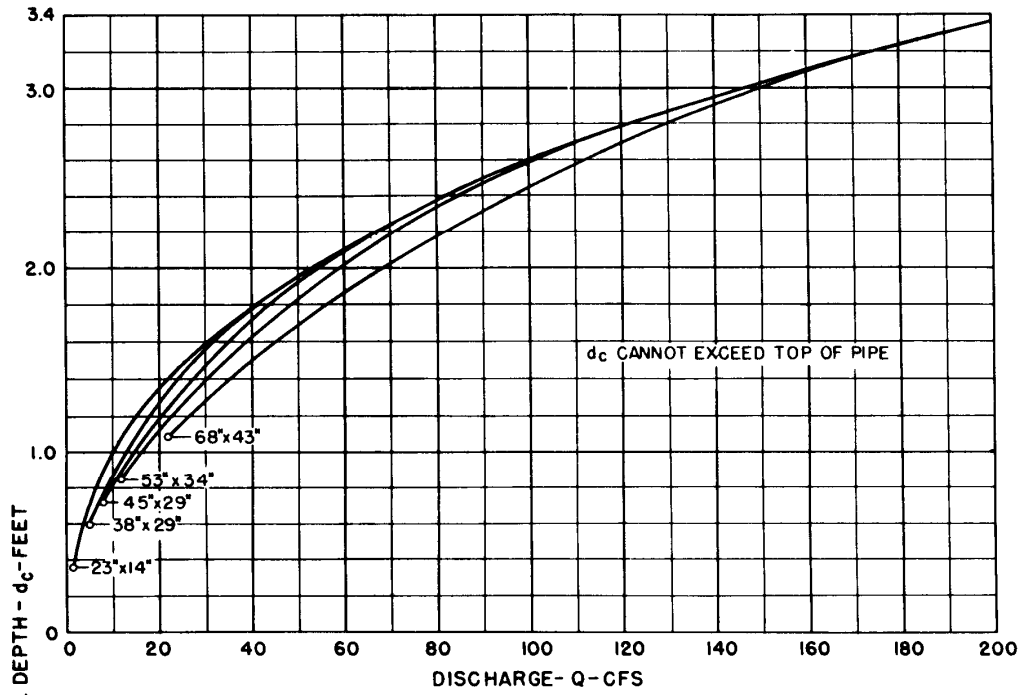
Source: HDS-5



HEADWATER DEPTH FOR  
OVAL CONCRETE PIPE CULVERTS  
LONG AXIS VERTICAL  
WITH INLET CONTROL

BUREAU OF PUBLIC ROADS JAN. 1963

Source: HDS-5



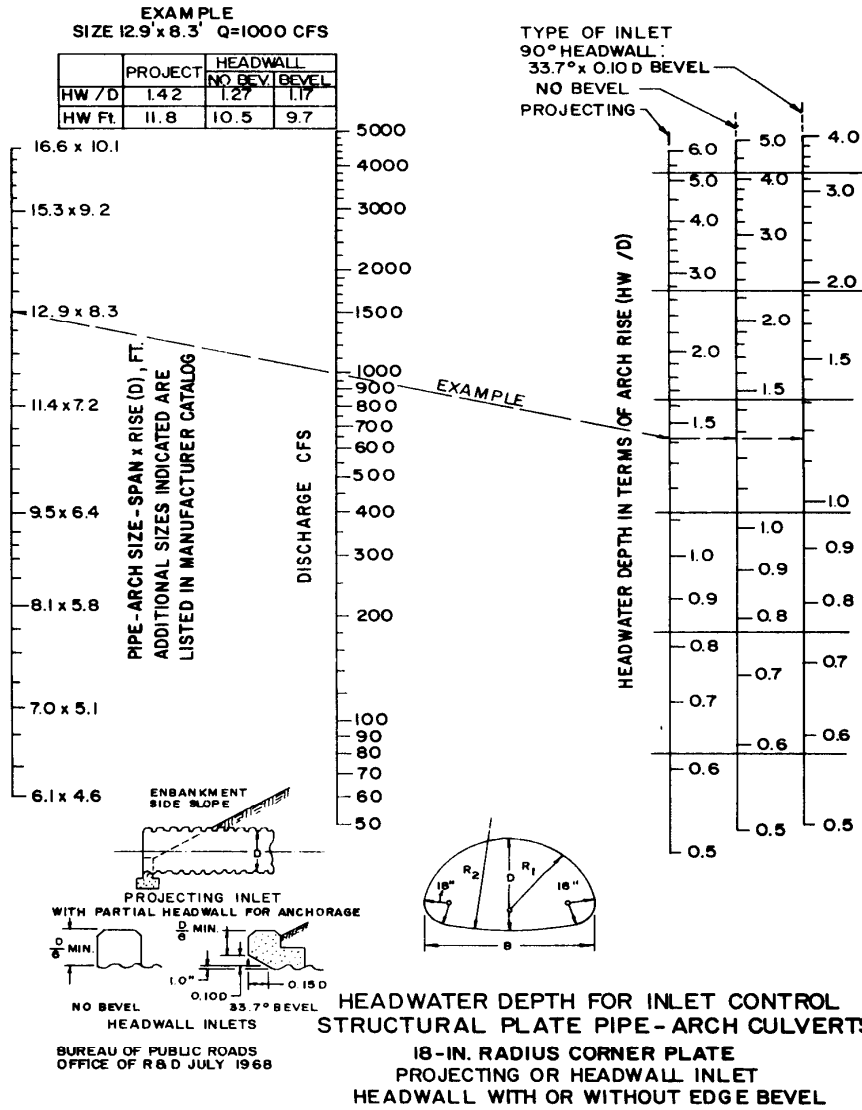
BUREAU OF PUBLIC ROADS  
JAN. 1964

**CRITICAL DEPTH  
OVAL CONCRETE PIPE  
LONG AXIS HORIZONTAL**

Source: HDS-5

Inlet Control,  
Structural Plate Pipe-Arch,  
18" Corner Radius

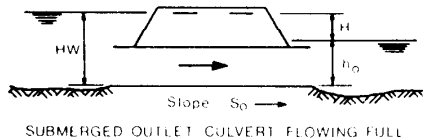
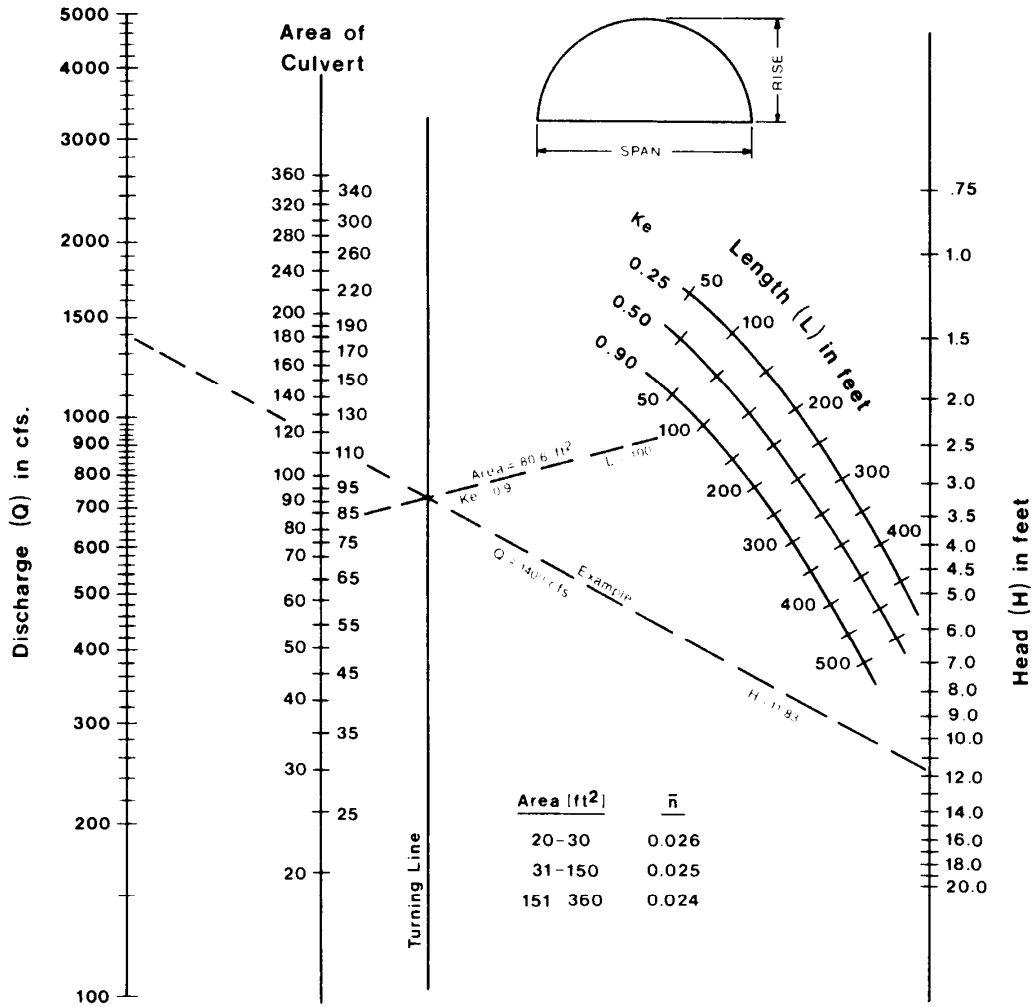
CHART 35



Source: HDS-5

Appendix 8C-47 Outlet Control, Corrugated Metal Arch,  
Concrete Bottom,  
 $0.5 \leq \text{Rise/Span}$

CHART 47



**HEAD FOR  
C.M. ARCH CULVERTS  
FLOWING FULL  
CONCRETE BOTTOM  
 $0.5 \leq \text{RISE / SPAN}$**

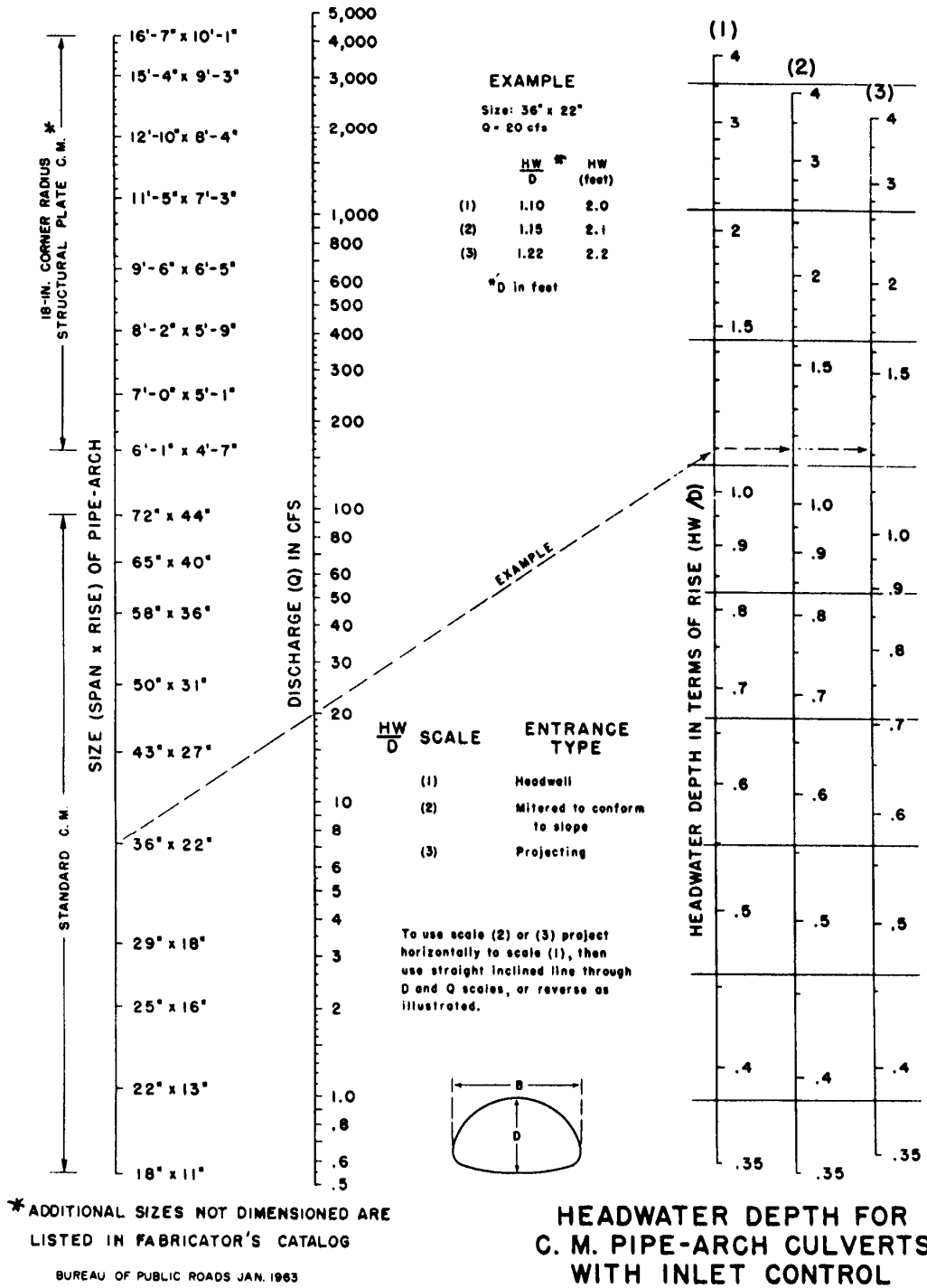
Nomographs adapted from material furnished by  
Kaiser Aluminum and Chemical Corporation

Duplication of this nomograph may distort scale

Source: HDS-5

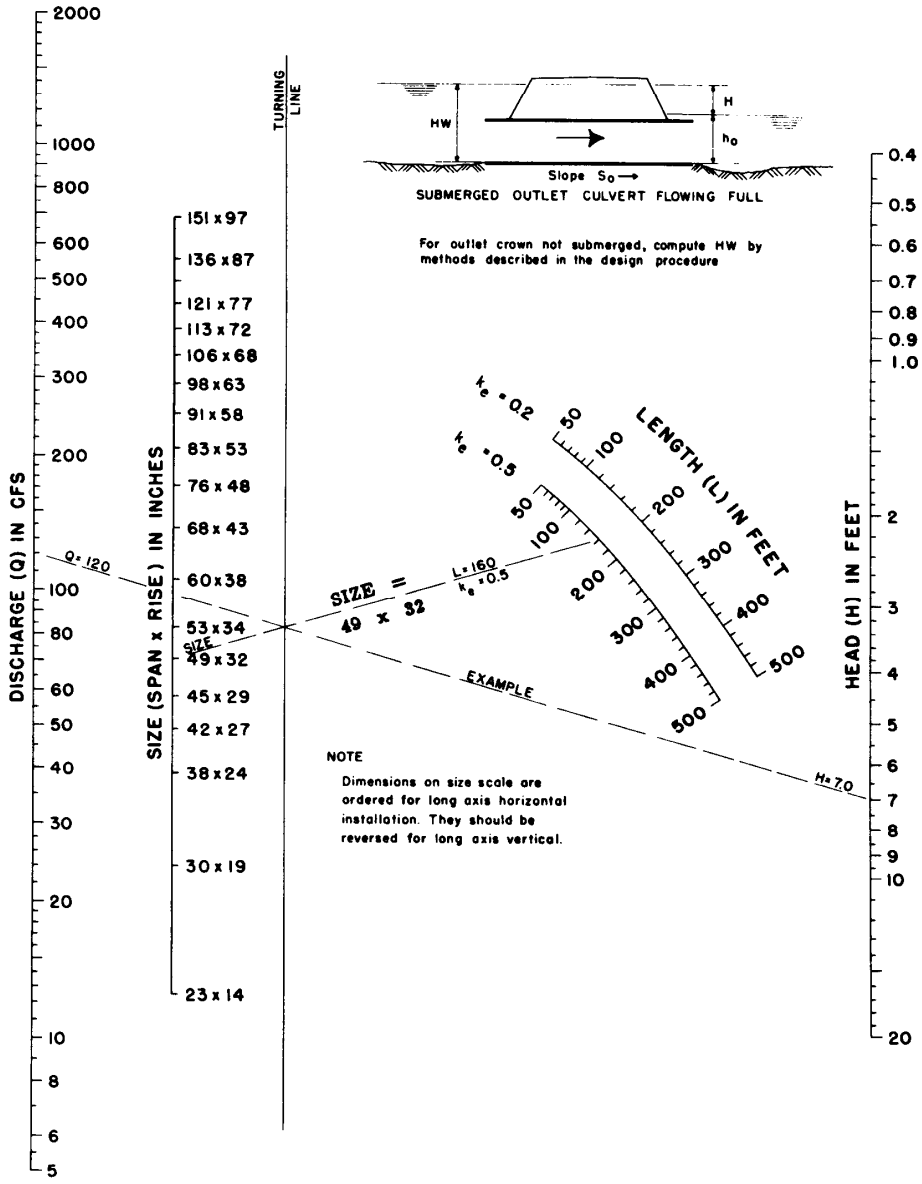


CHART 34



Source: HDS-5

CHART 33



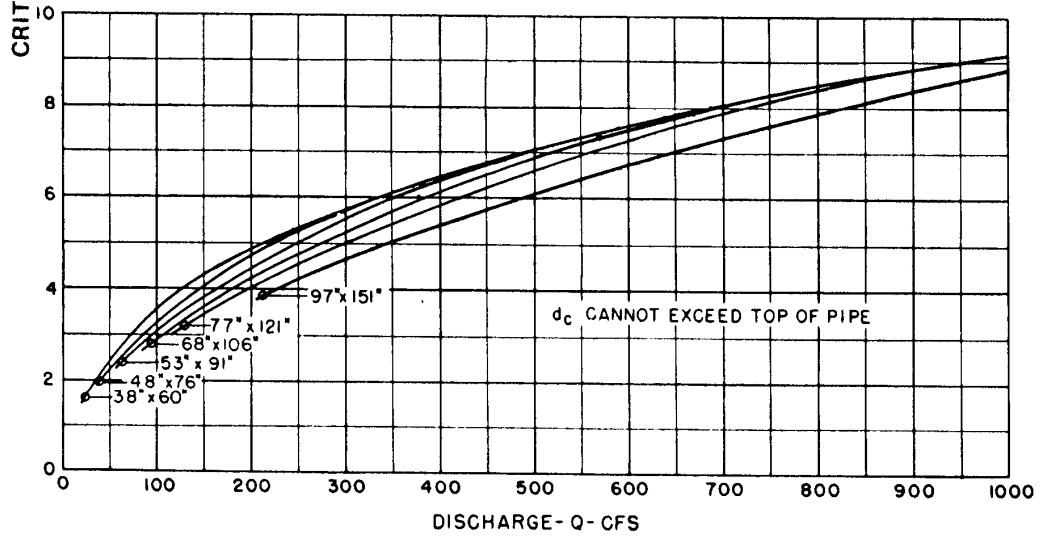
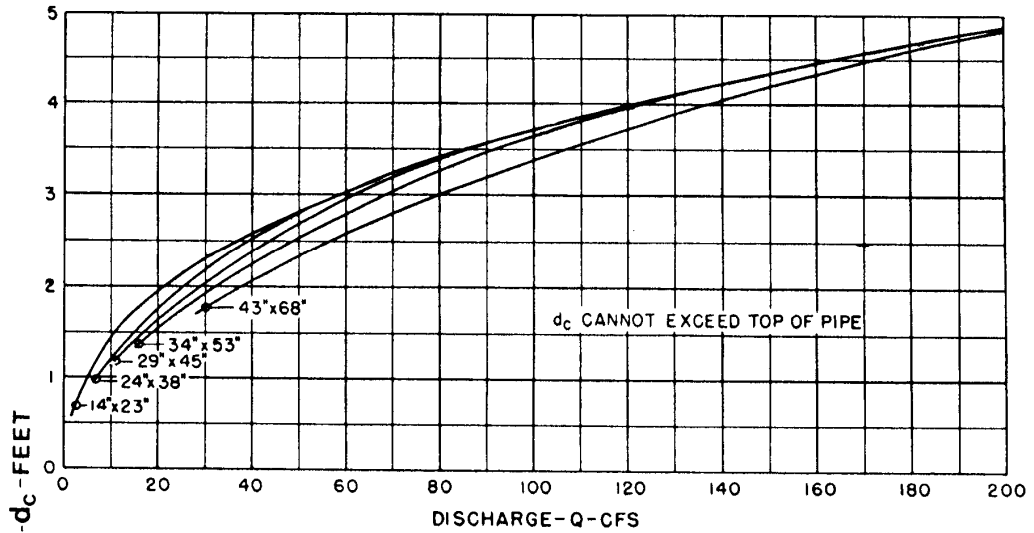
**HEAD FOR  
OVAL CONCRETE PIPE CULVERTS  
LONG AXIS HORIZONTAL OR VERTICAL  
FLOWING FULL  
n = 0.012**

BUREAU OF PUBLIC ROADS JAN. 1963

Source: HDS-5



Appendix 8C-32 Critical Depth, Oval Concrete,  
Long Axis Vertical



BUREAU OF PUBLIC ROADS  
JAN. 1964

CRITICAL DEPTH  
OVAL CONCRETE PIPE  
LONG AXIS VERTICAL

Source: HDS-5

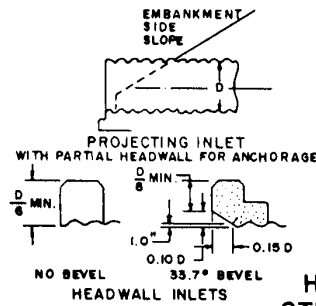
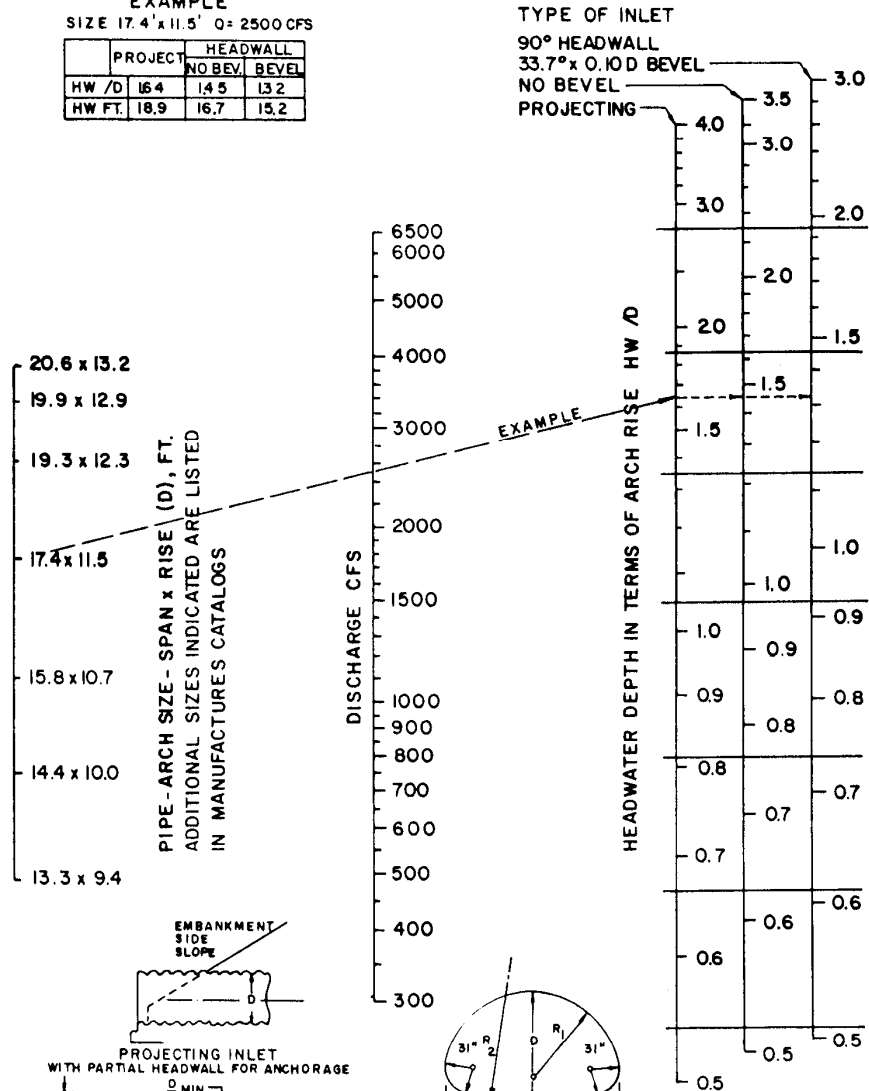
Inlet Control,  
Structural Plate Pipe-Arch,  
31" Corner Radius



CHART 36

EXAMPLE  
SIZE 17.4' x 11.5' Q = 2500 CFS

	PROJECT	HEADWALL	
		NO BEV.	BEVEL
HW / D	1.64	1.45	1.32
HW FT.	18.9	16.7	15.2



HEADWATER DEPTH FOR INLET CONTROL  
STRUCTURAL PLATE PIPE-ARCH CULVERTS

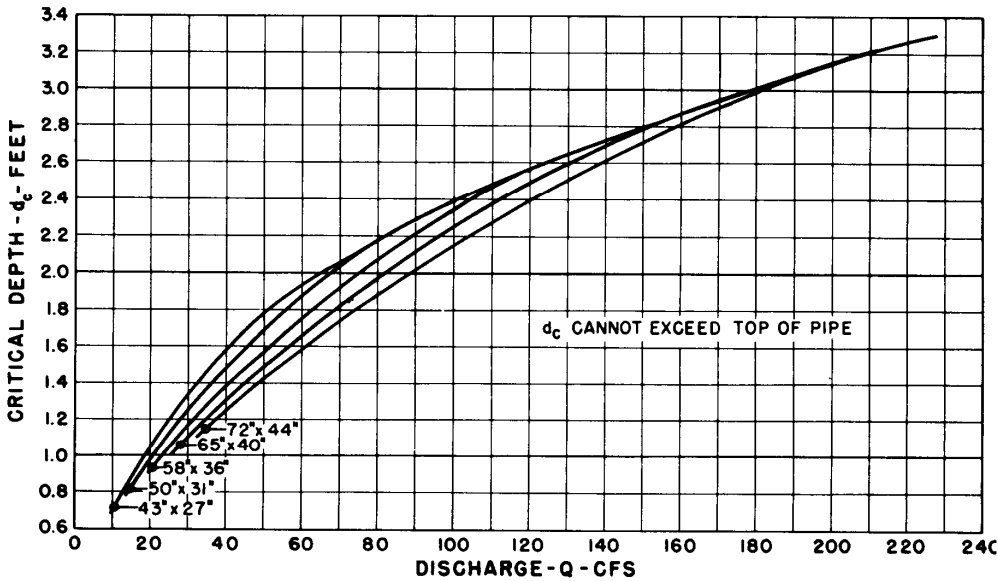
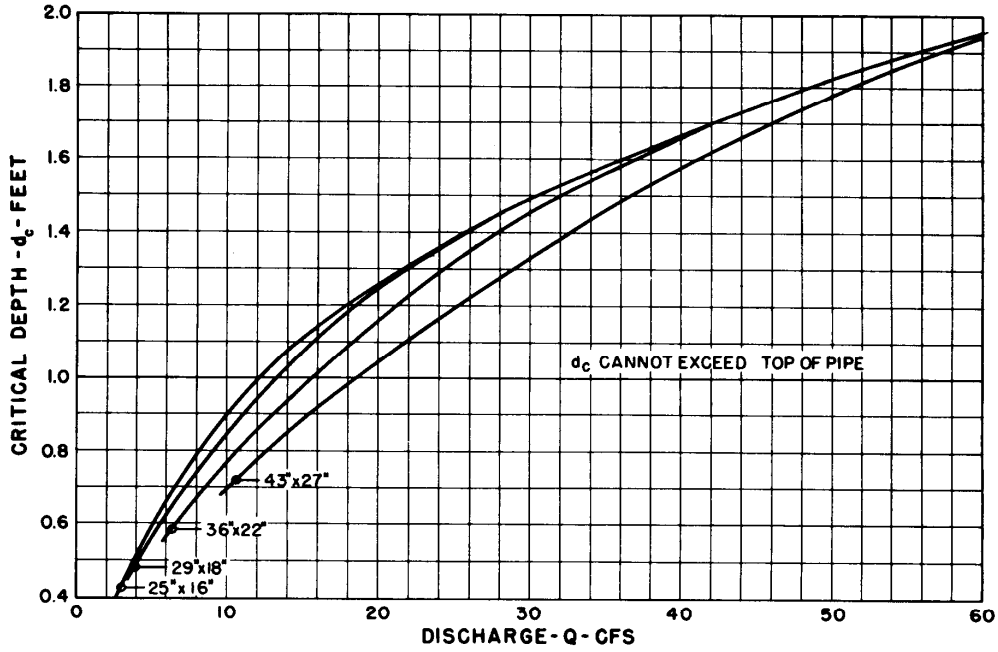
31-IN. RADIUS CORNER PLATE  
PROJECTING OR HEADWALL INLET  
HEADWALL WITH OR WITHOUT EDGE BEVEL

BUREAU OF PUBLIC ROADS  
OFFICE OF R&D JULY 1968

Source: HDS-5



CHART 37



BUREAU OF PUBLIC ROADS  
JAN. 1964

CRITICAL DEPTH  
STANDARD C. M. PIPE-ARCH

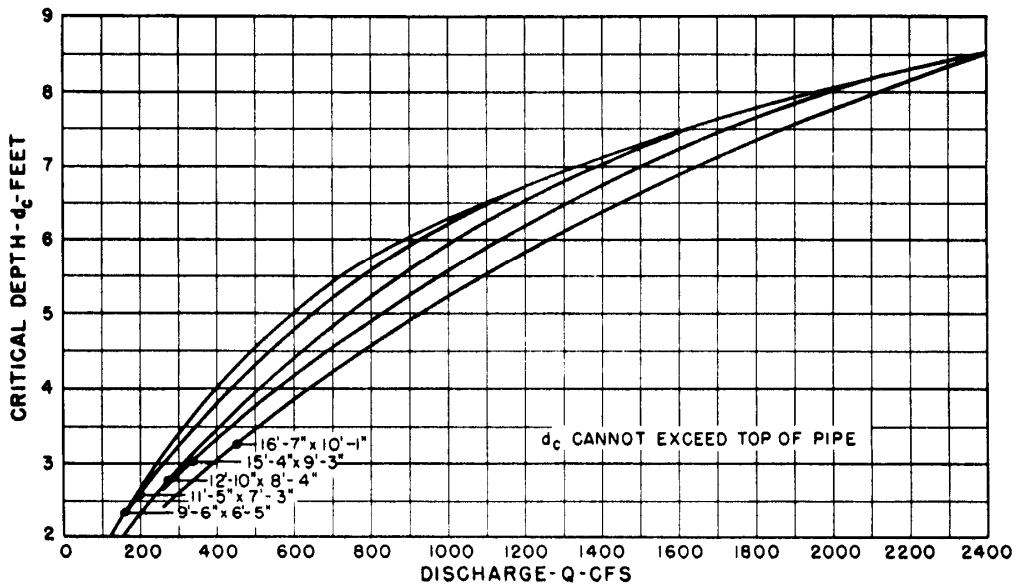
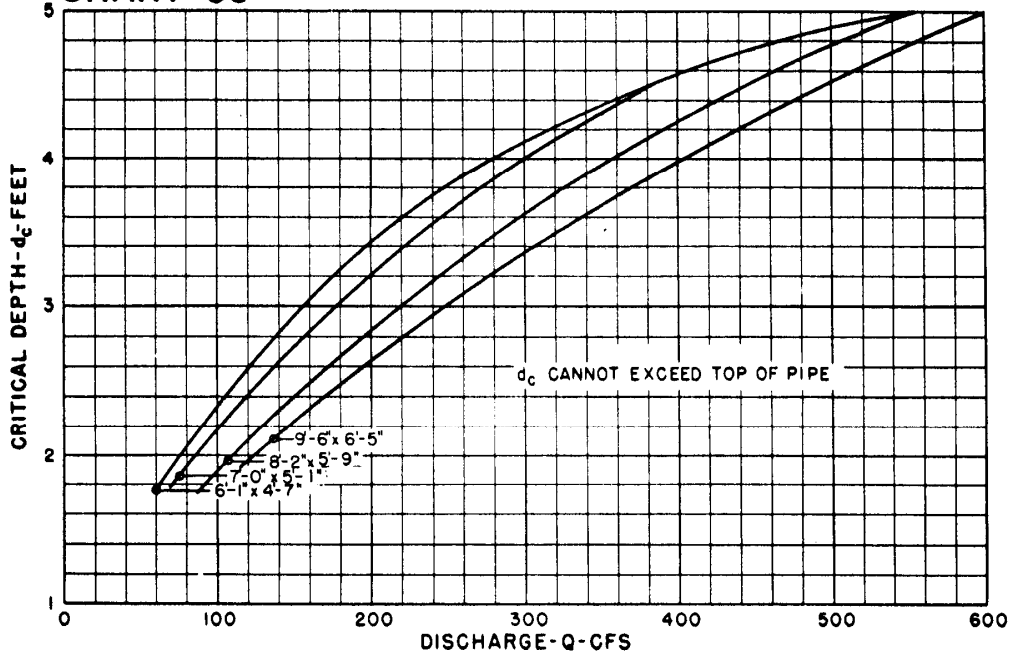
Source: HDS-5

Appendix 8C-38

Critical Depth, Structural Plate  
Corrugated Metal Pipe-Arch,  
18" Corner Radius



CHART 38



BUREAU OF PUBLIC ROADS  
JAN. 1964

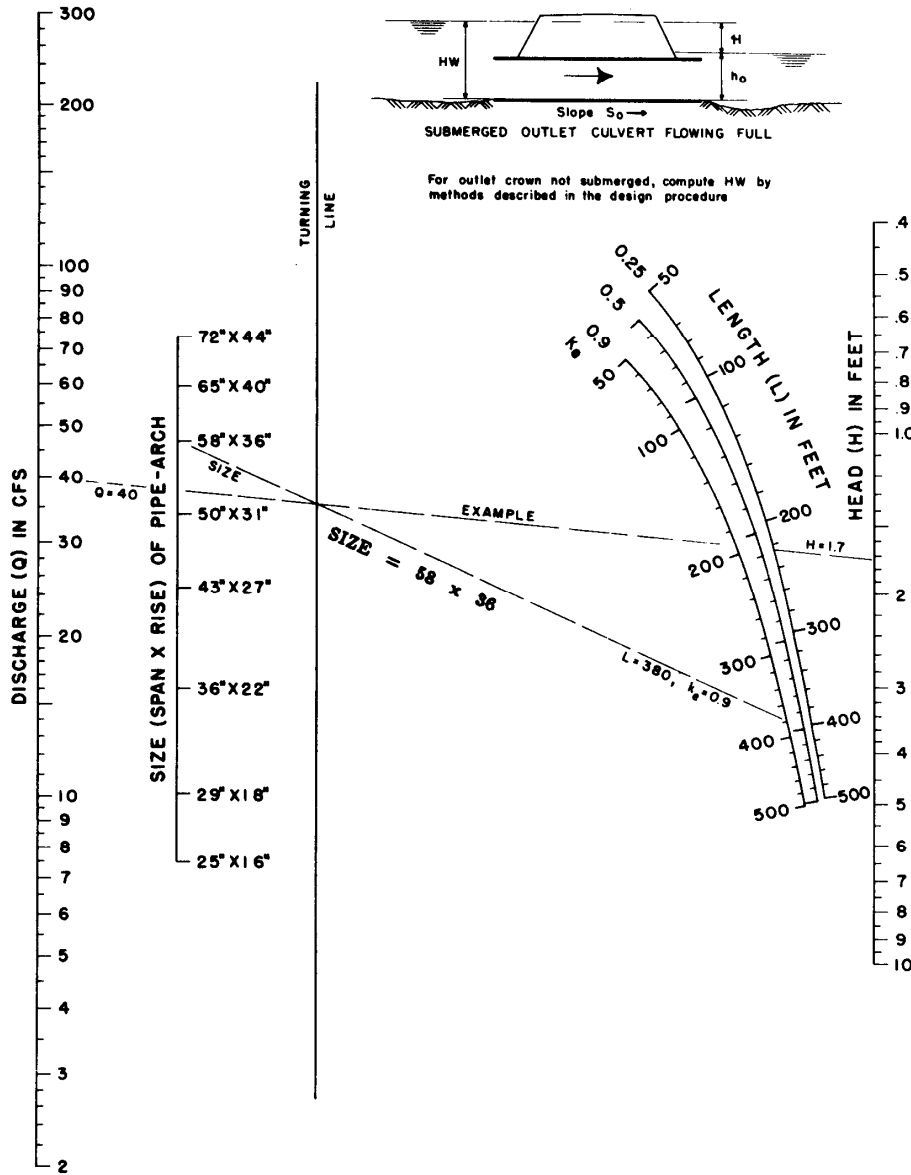
CRITICAL DEPTH  
STRUCTURAL PLATE  
C. M. PIPE-ARCH  
18 INCH CORNER RADIUS

Source: HDS-5

Appendix 8C-39 Outlet Control, Standard Corrugated Metal Pipe-Arch



CHART 39



HEAD FOR STANDARD C. M. PIPE-ARCH CULVERTS FLOWING FULL n=0.024

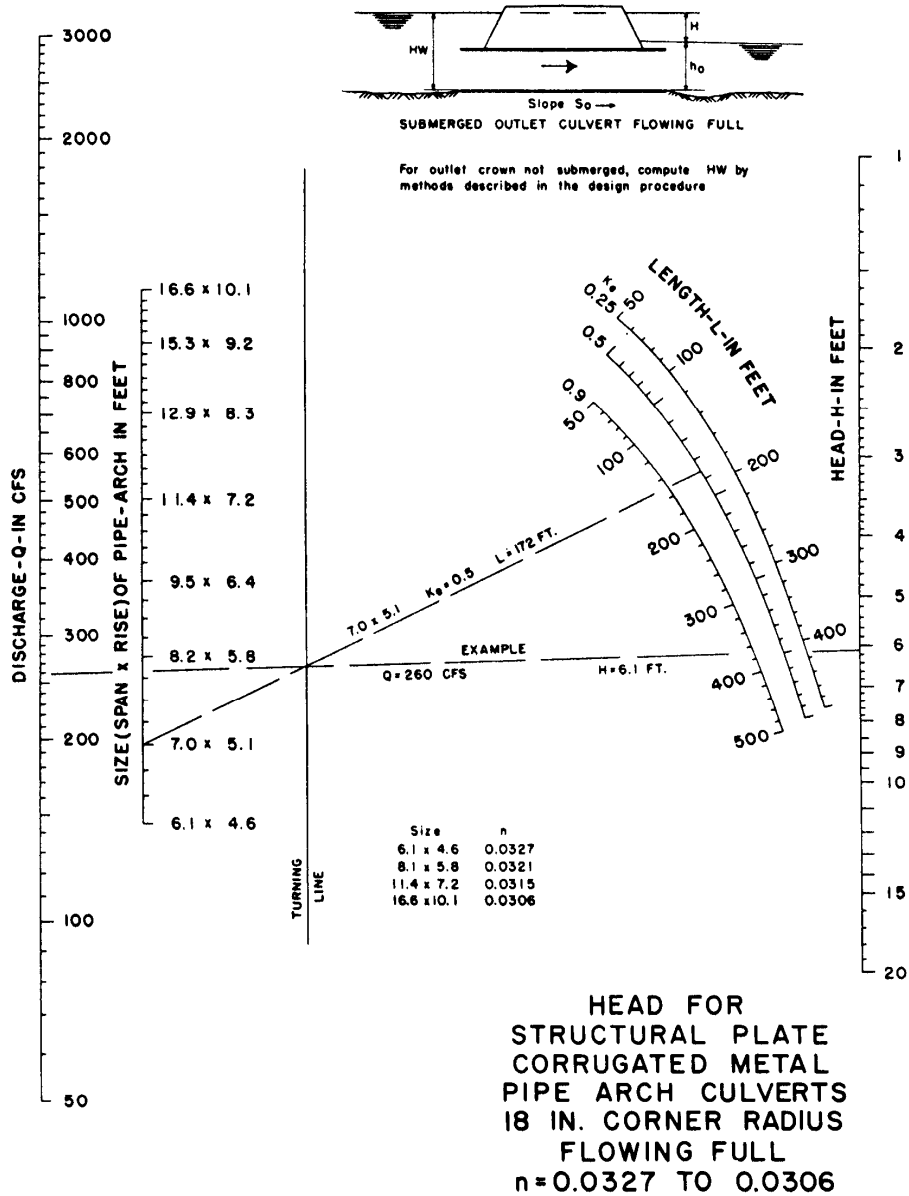
BUREAU OF PUBLIC ROADS JAN. 1963

Source: HDS-5

Outlet Control,  
Structural Plate Corrugated Metal  
Pipe-Arch, 18" Corner Radius



CHART 40

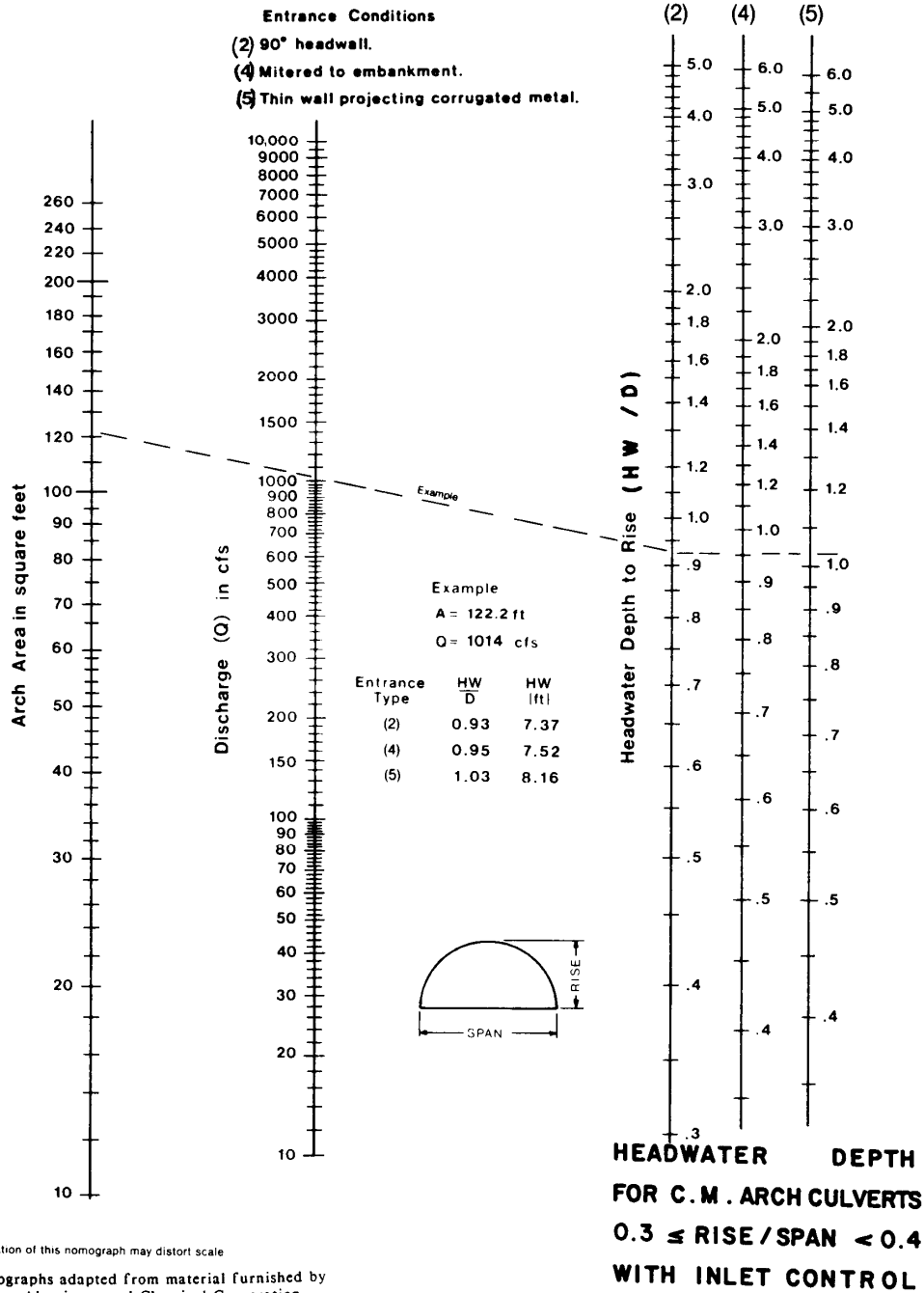


BUREAU OF PUBLIC ROADS JAN. 1963

Source: HDS-5

Appendix 8C-41 Inlet Control, Corrugated Metal Arch,  
 $0.3 \leq \text{Rise/Span} < 0.4$

CHART 41



Duplication of this nomograph may distort scale

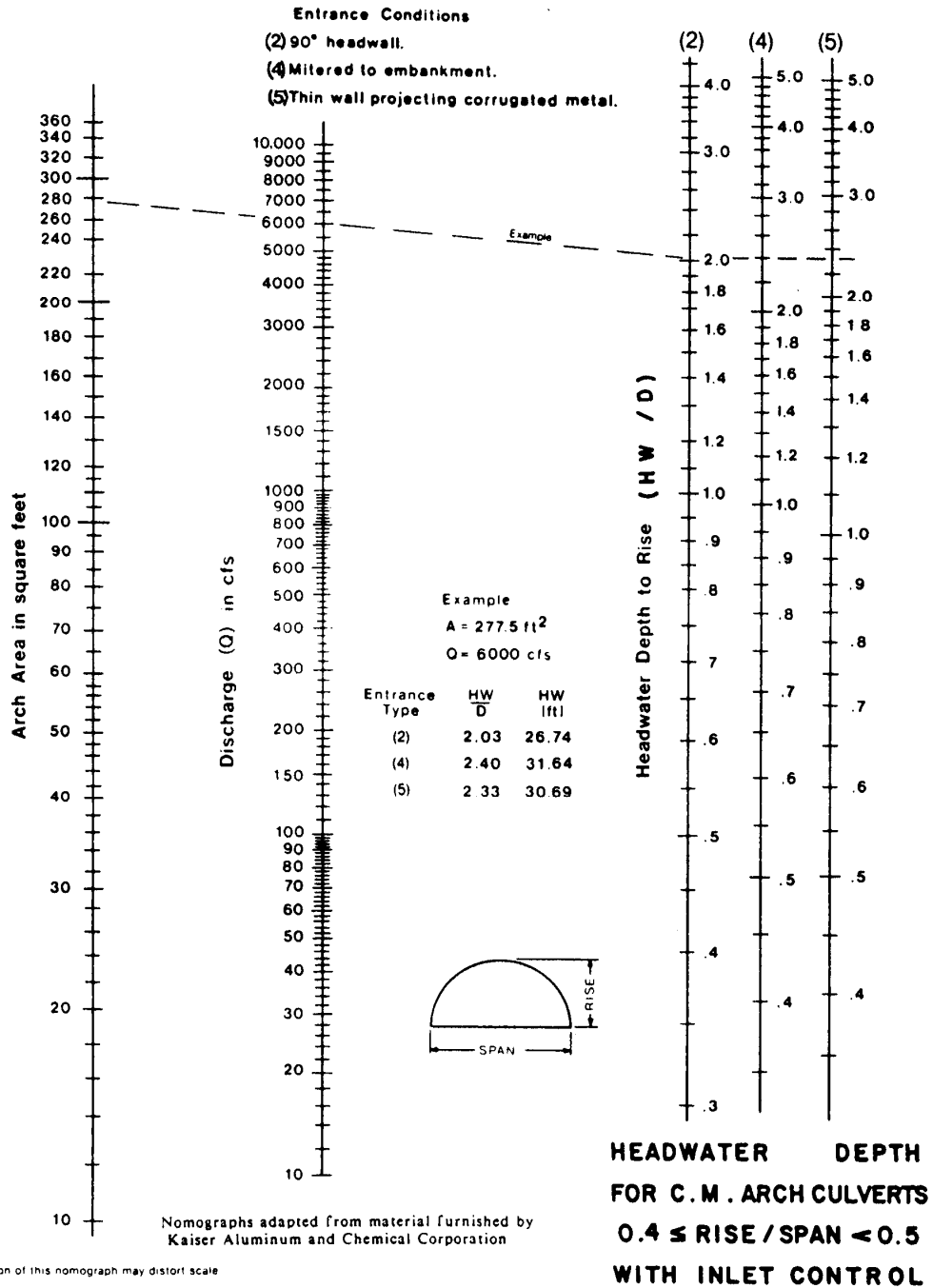
Nomographs adapted from material furnished by  
 Kaiser Aluminum and Chemical Corporation

Source: HDS-5

Appendix 8C-42 Inlet Control, Corrugated Metal Arch,  $0.4 \leq \text{Rise/Span} < 0.5$



CHART 42

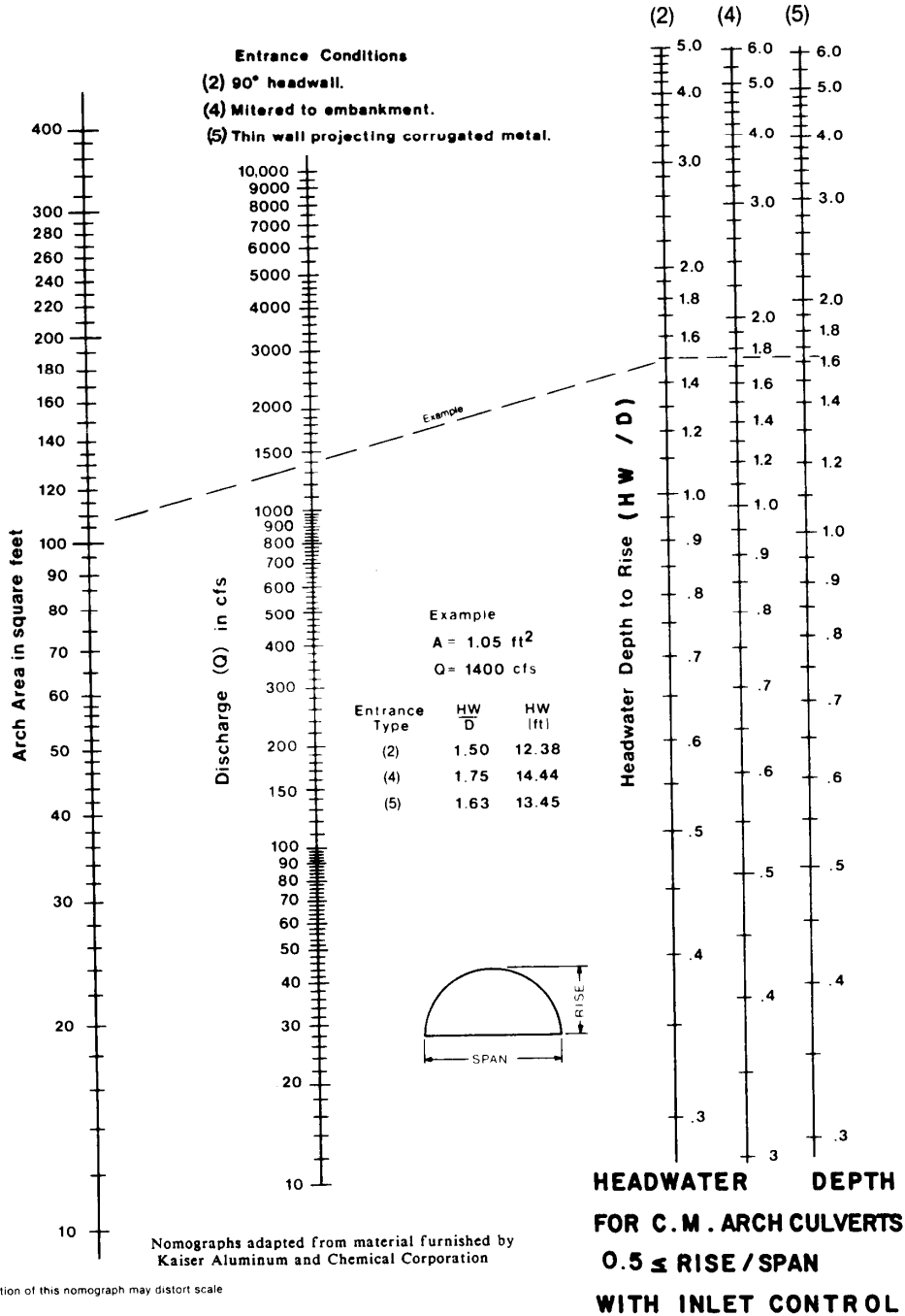


Source: HDS-5



Appendix 8C-43 Inlet Control, Corrugated Metal Arch,  $0.5 \leq \text{Rise/Span}$

CHART 43

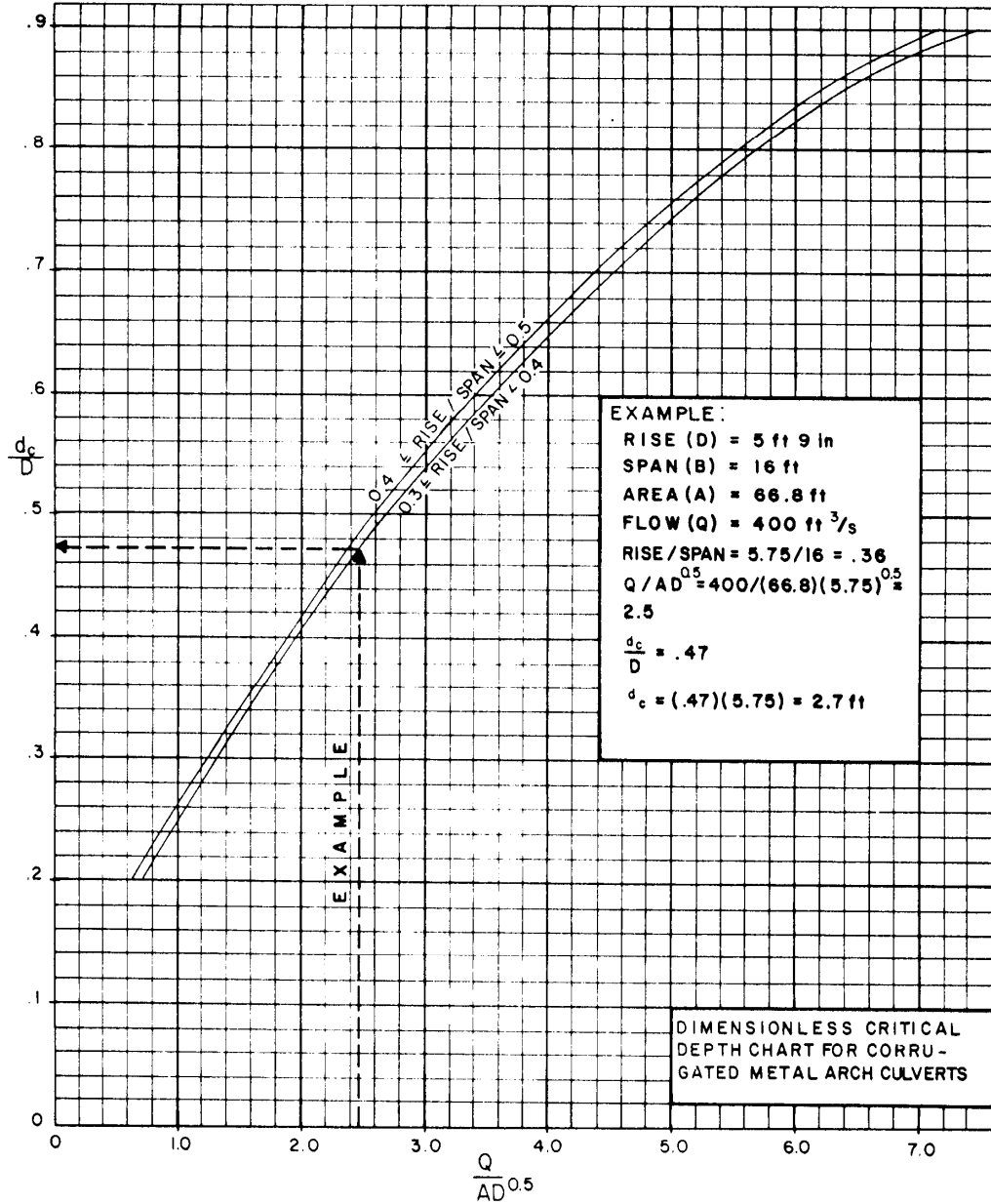


Source: HDS-5

Appendix 8C-44 Critical Depth, Corrugated Metal Arch

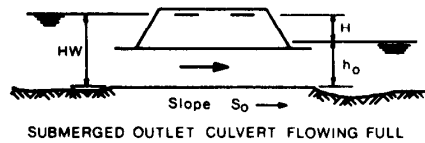
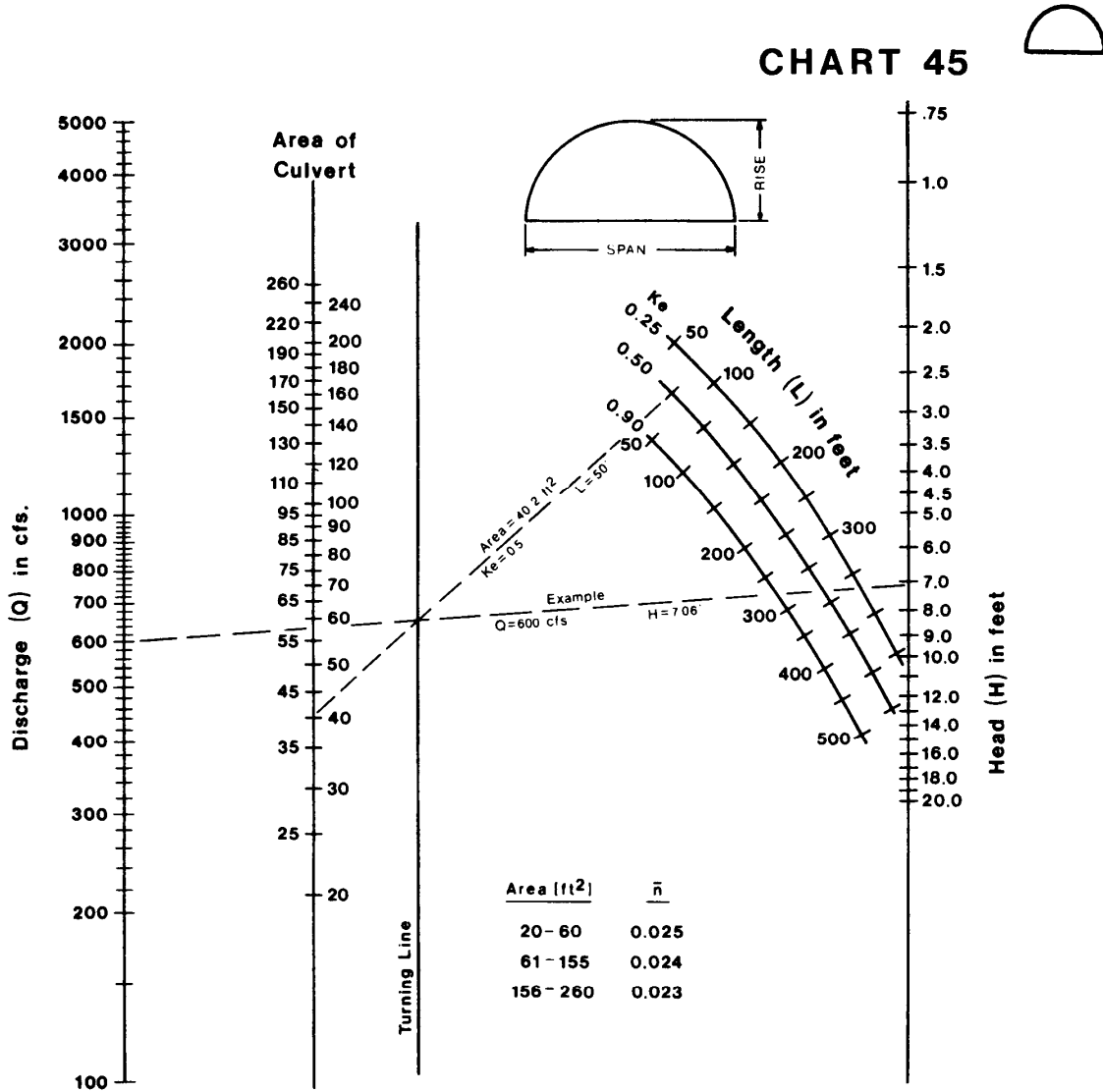


CHART 44



Source: HDS-5

Appendix 8C-45 Outlet Control, Corrugated Metal Arch,  
Concrete Bottom,  
 $0.3 \leq \text{Rise/Span} < 0.4$



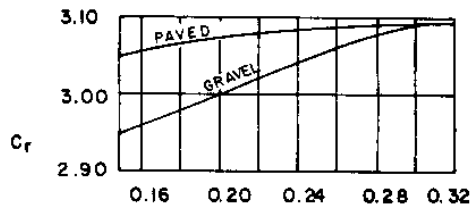
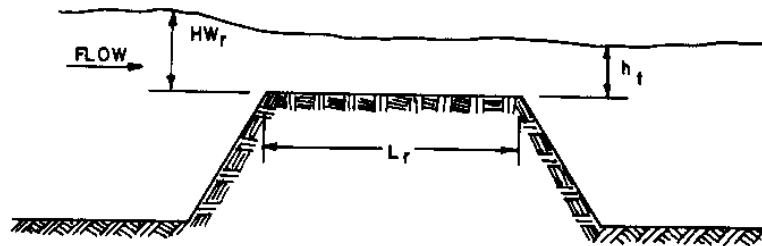
**HEAD FOR  
C. M. ARCH CULVERTS  
FLOWING FULL  
CONCRETE BOTTOM  
 $0.3 \leq \text{RISE} / \text{SPAN} < 0.4$**

Nomographs adapted from material furnished by  
Kaiser Aluminium and Chemical Corporation

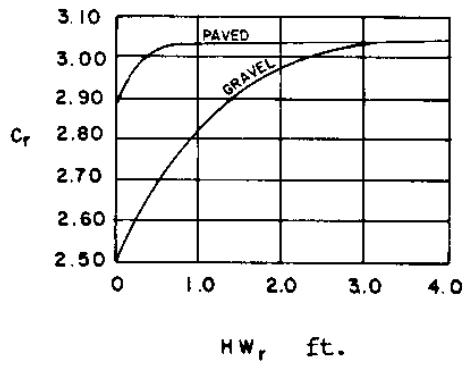
Duplication of this nomograph may distort scale

Source: HDS-5

Chart 8C-60 Discharge Coefficients for Roadway Overtopping



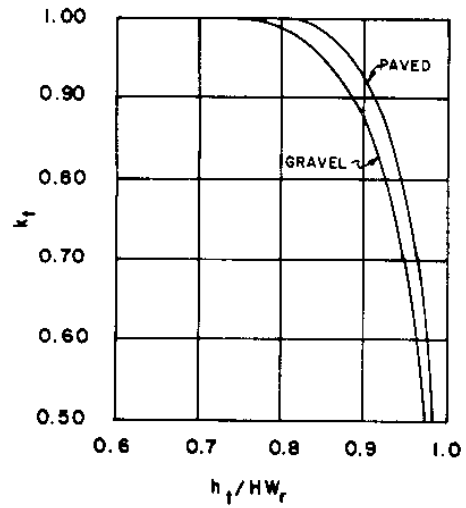
A) DISCHARGE COEFFICIENT FOR HW<sub>r</sub>/L<sub>r</sub> > 0.15



B) DISCHARGE COEFFICIENT FOR HW<sub>r</sub>/L<sub>r</sub> ≤ 0.15

$$C_d = k_t C_r$$

$$Q_r = C_d L H W_r^{1.5}$$



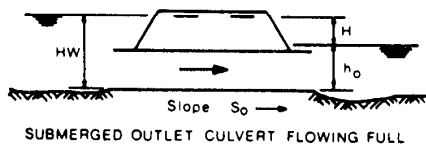
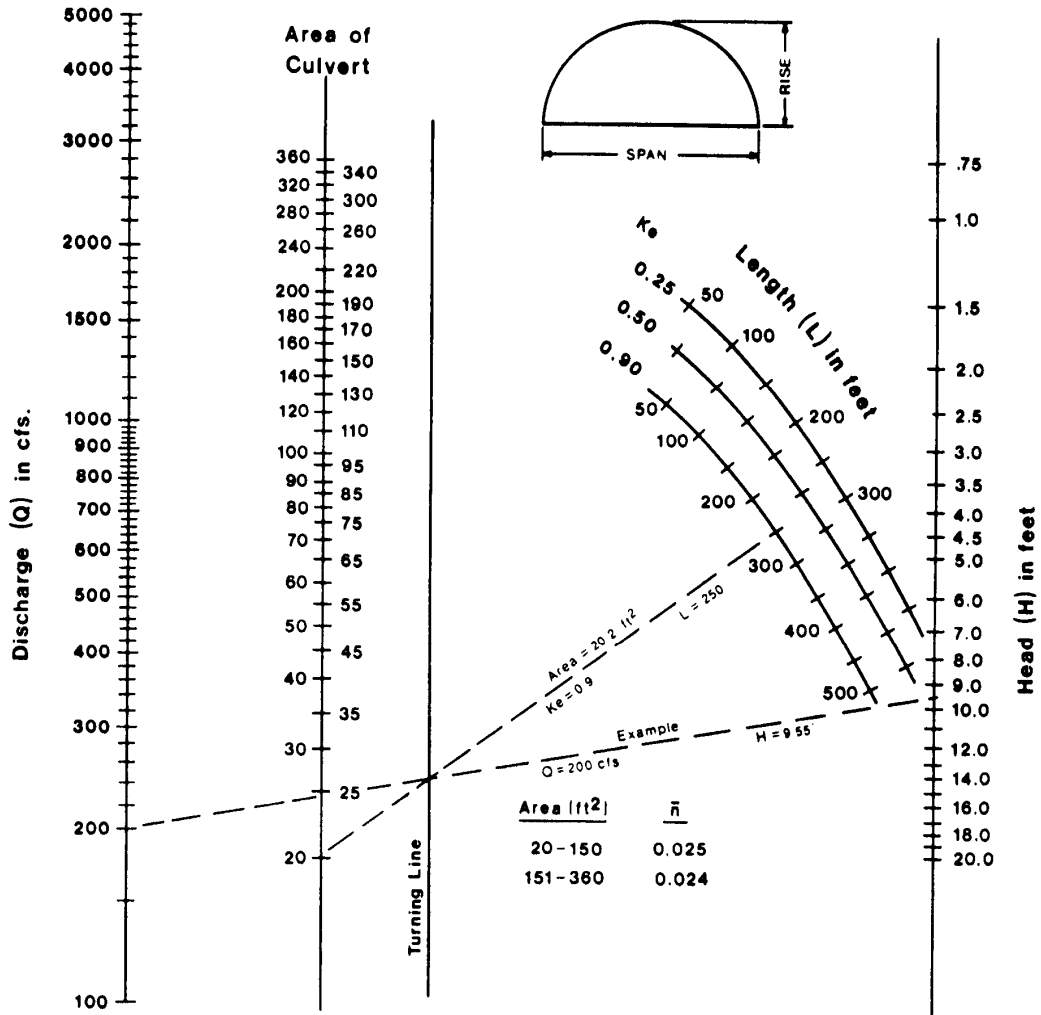
C) SUBMERGENCE FACTOR

DISCHARGE COEFFICIENTS  
FOR ROADWAY OVERTOPPING

Appendix 8C-46 Outlet Control, Corrugated Metal Arch,  
Concrete Bottom,  
 $0.4 \leq \text{Rise/Span} < 0.5$



CHART 46



**HEAD FOR  
C.M. ARCH CULVERTS  
FLOWING FULL  
CONCRETE BOTTOM  
 $0.4 \leq \text{RISE} / \text{SPAN} < 0.5$**

Nomographs adapted from material furnished by  
Kaiser Aluminum and Chemical Corporation

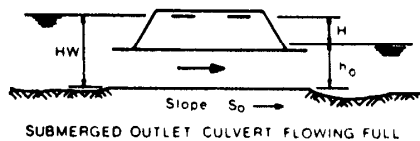
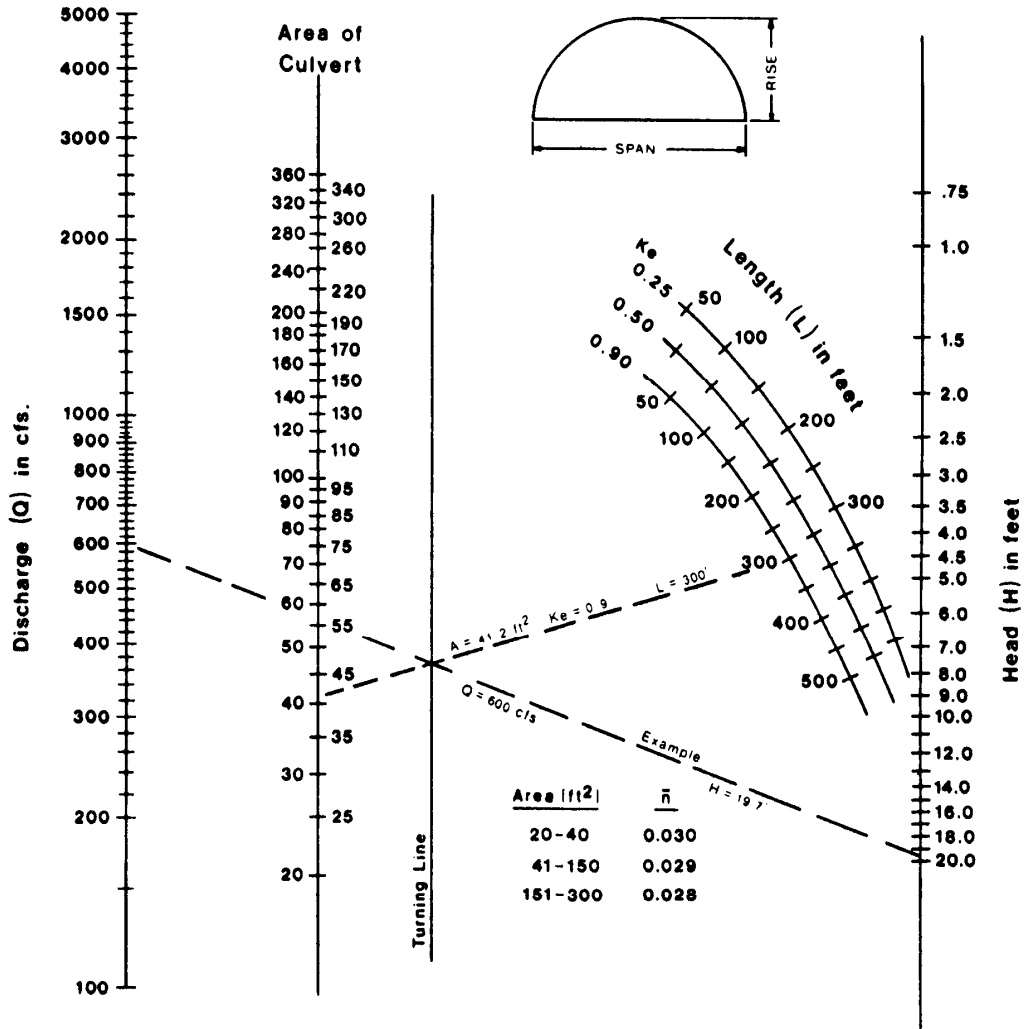
Duplication of this nomograph may distort scale

Source: HDS-5

Appendix 8C-50 Outlet Control, Corrugated Metal Arch,  
Earth Bottom,  
 $0.5 \leq \text{Rise/Span}$



CHART 50



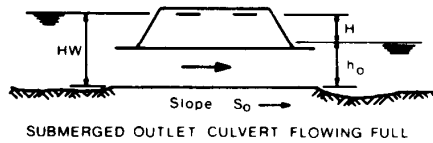
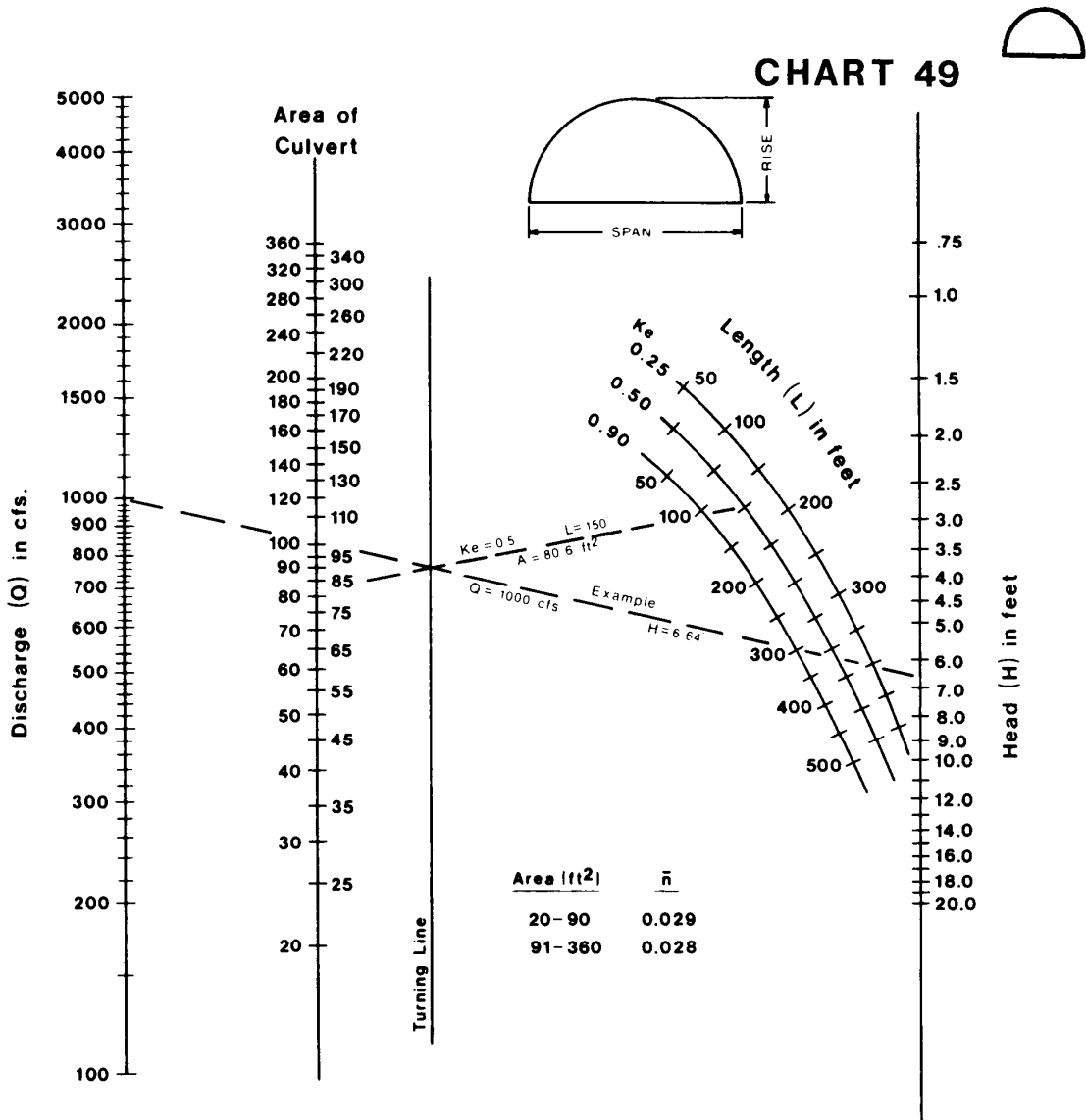
**HEAD FOR  
C.M. ARCH CULVERTS  
FLOWING FULL  
EARTH BOTTOM ( $n_b = 0.022$ )  
 $0.5 \leq \text{RISE / SPAN}$**

Nomographs adapted from material furnished by  
Kaiser Aluminum and Chemical Corporation

Duplication of this nomograph may distort scale

Source: HDS-5

Appendix 8C-49 Outlet Control, Corrugated Metal Arch,  
Earth Bottom,  
 $0.4 \leq \text{Rise/SPAN} < 0.5$



**HEAD FOR  
C.M. ARCH CULVERTS  
FLOWING FULL  
EARTH BOTTOM ( $n_b = 0.022$ )  
 $0.4 \leq \text{RISE} / \text{SPAN} < 0.5$**

Nomographs adapted from material furnished by  
Kaiser Aluminum and Chemical Corporation

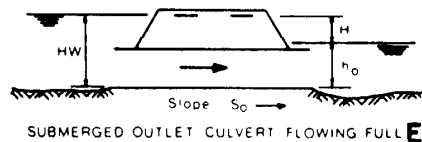
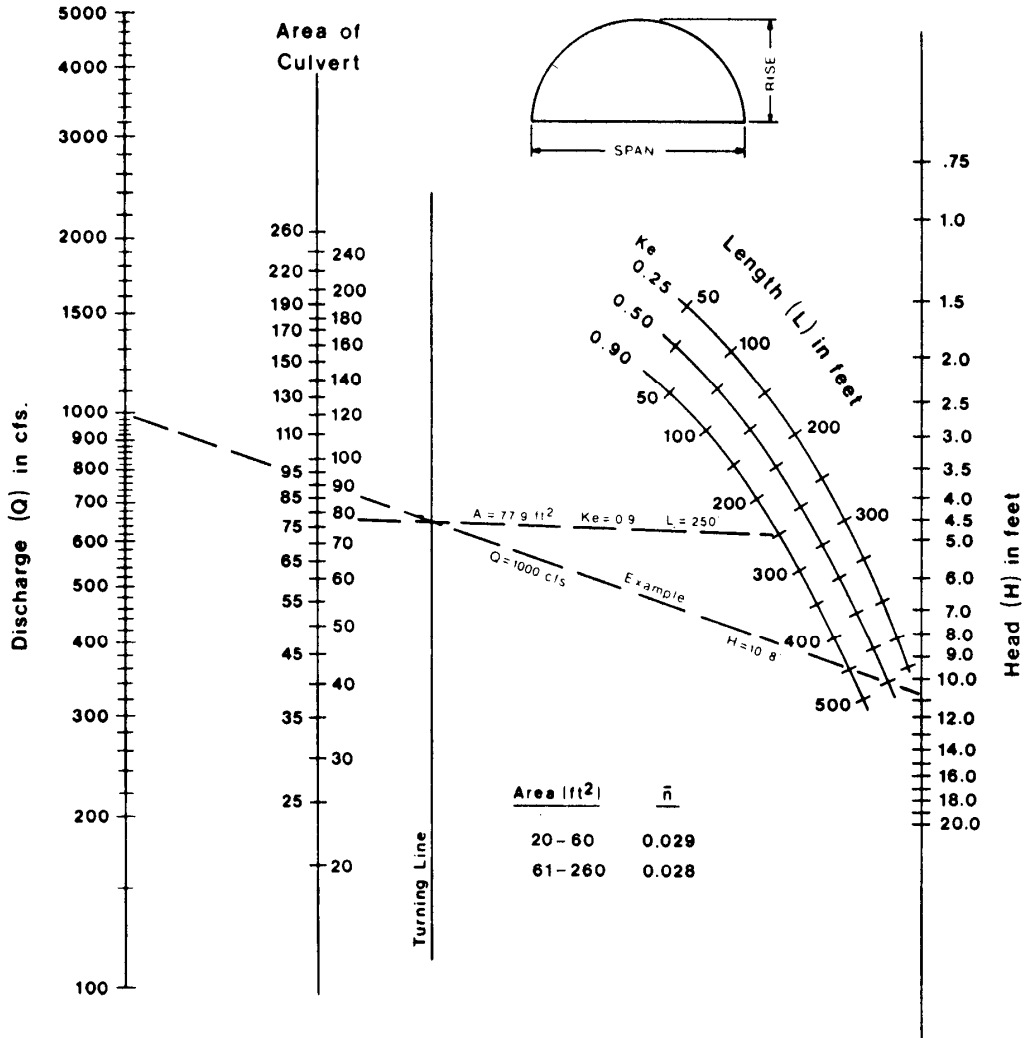
Duplication of this nomograph may distort scale

Source: HDS-5

Appendix 8C-48 Outlet Control, Corrugated Metal Arch,  
Earth Bottom,  
 $0.3 \leq \text{Rise/SPAN} < 0.4$



CHART 48



SUBMERGED OUTLET CULVERT FLOWING FULL

**HEAD FOR  
C. M. ARCH CULVERTS  
FLOWING FULL  
EARTH BOTTOM ( $n_b = 0.022$ )  
 $0.3 \leq \text{RISE} / \text{SPAN} < 0.4$**

Nomographs adapted from material furnished by  
Kaiser Aluminum and Chemical Corporation

Duplication of this nomograph may distort scale

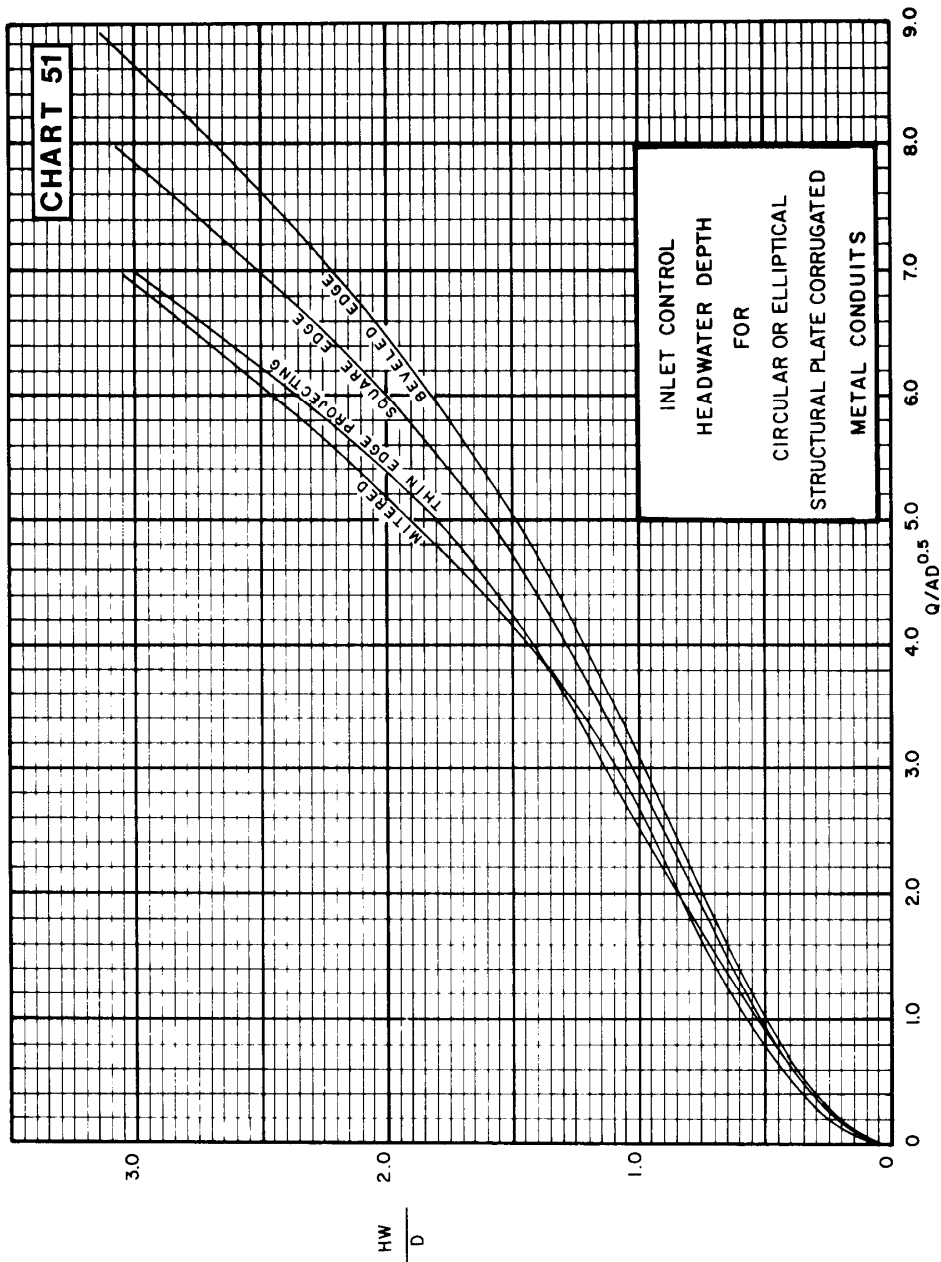
Source: HDS-5



Inlet Control,  
Structural Plate Corrugated Metal,  
Circular or Elliptical



CHART 51



Source: HDS-5

Inlet Control,  
Structural Plate Corrugated  
Metal Arch, High and Low Profile

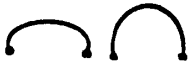
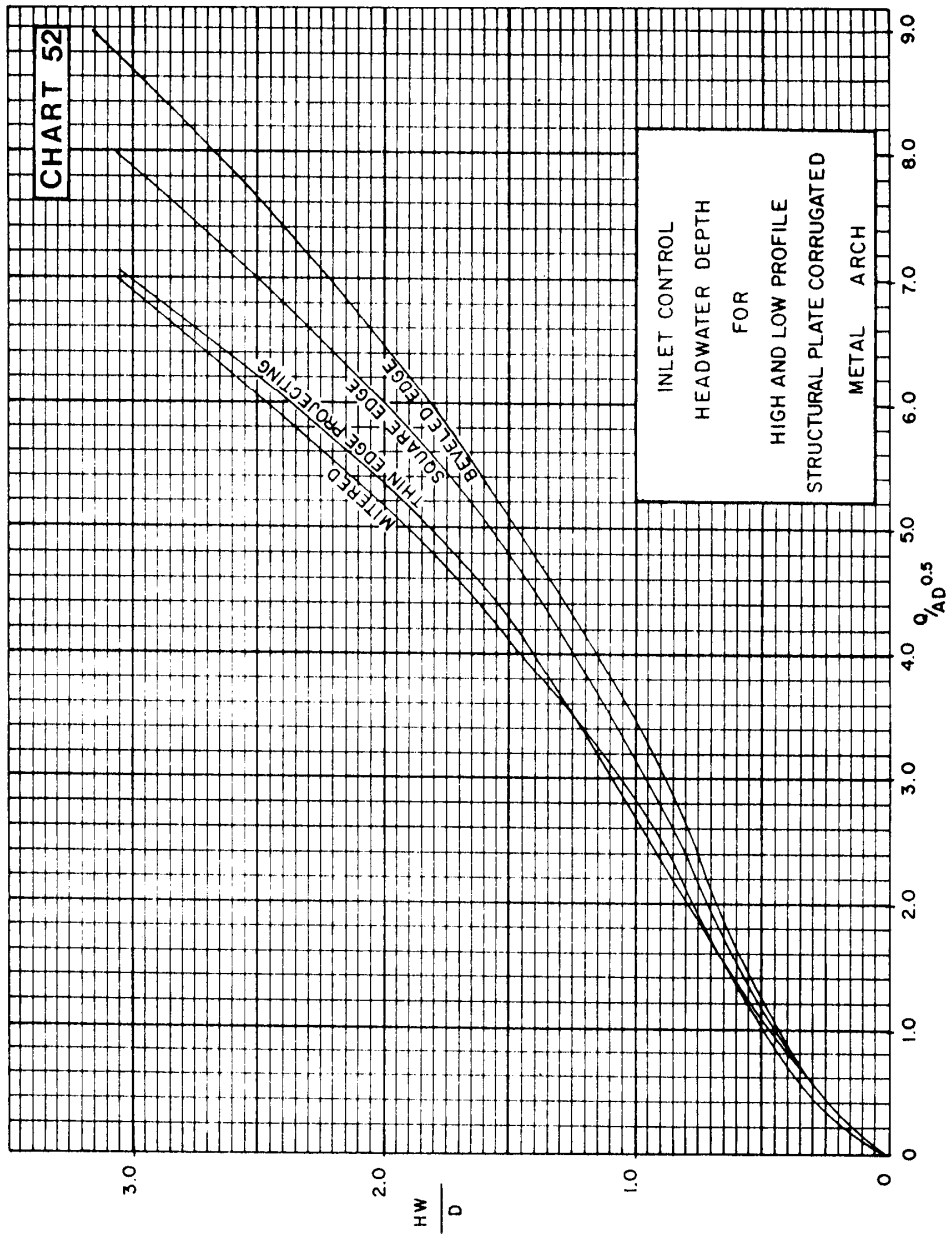


CHART 52



Source: HDS-5

Appendix 8C-54 Critical Depth, Structural Plate Arch, Low and High Profile

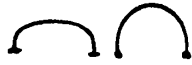
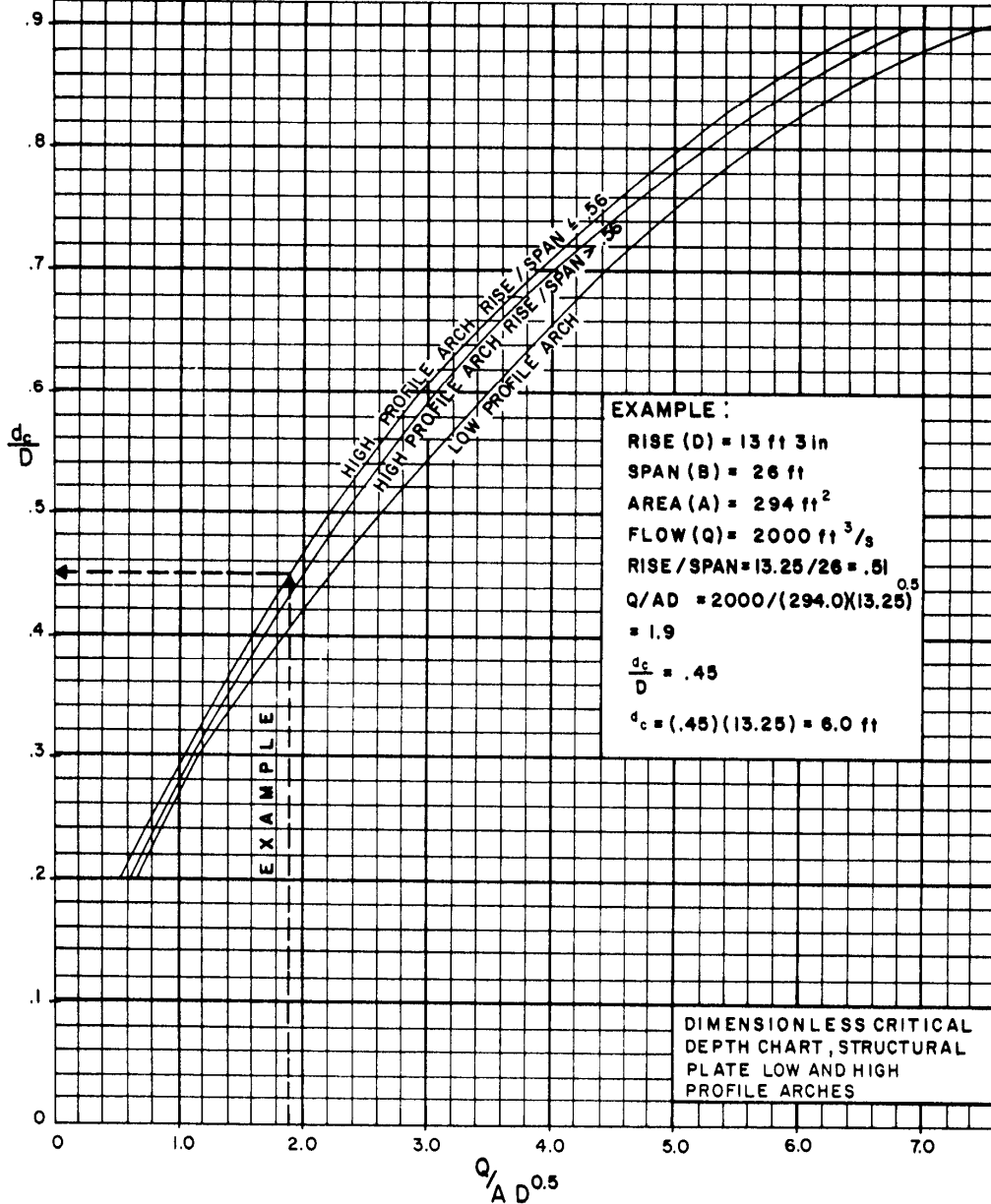


CHART 54

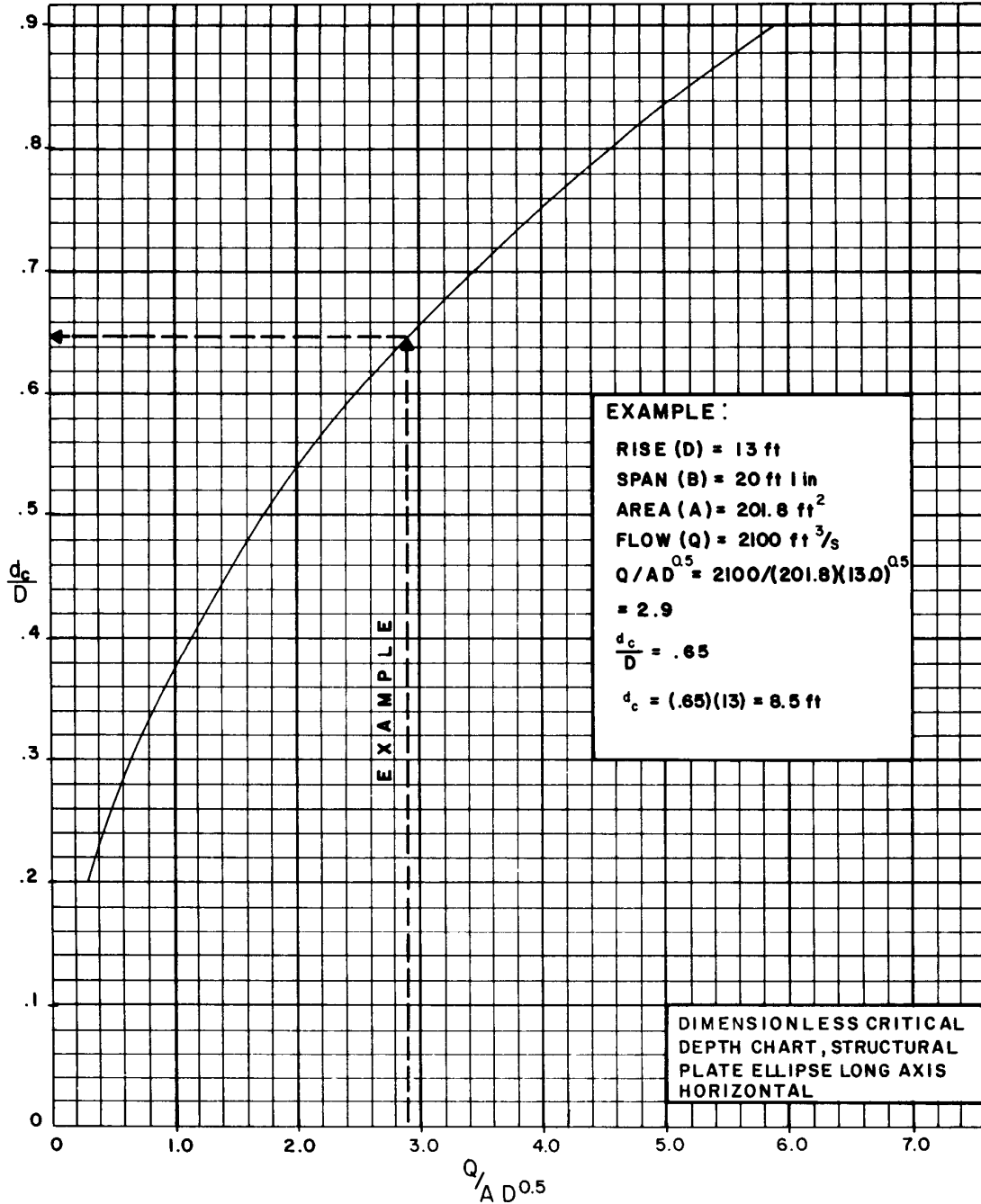


Source: HDS-5

Appendix 8C-53 Critical Depth, Structural Plate Ellipse,  
Long Axis Horizontal



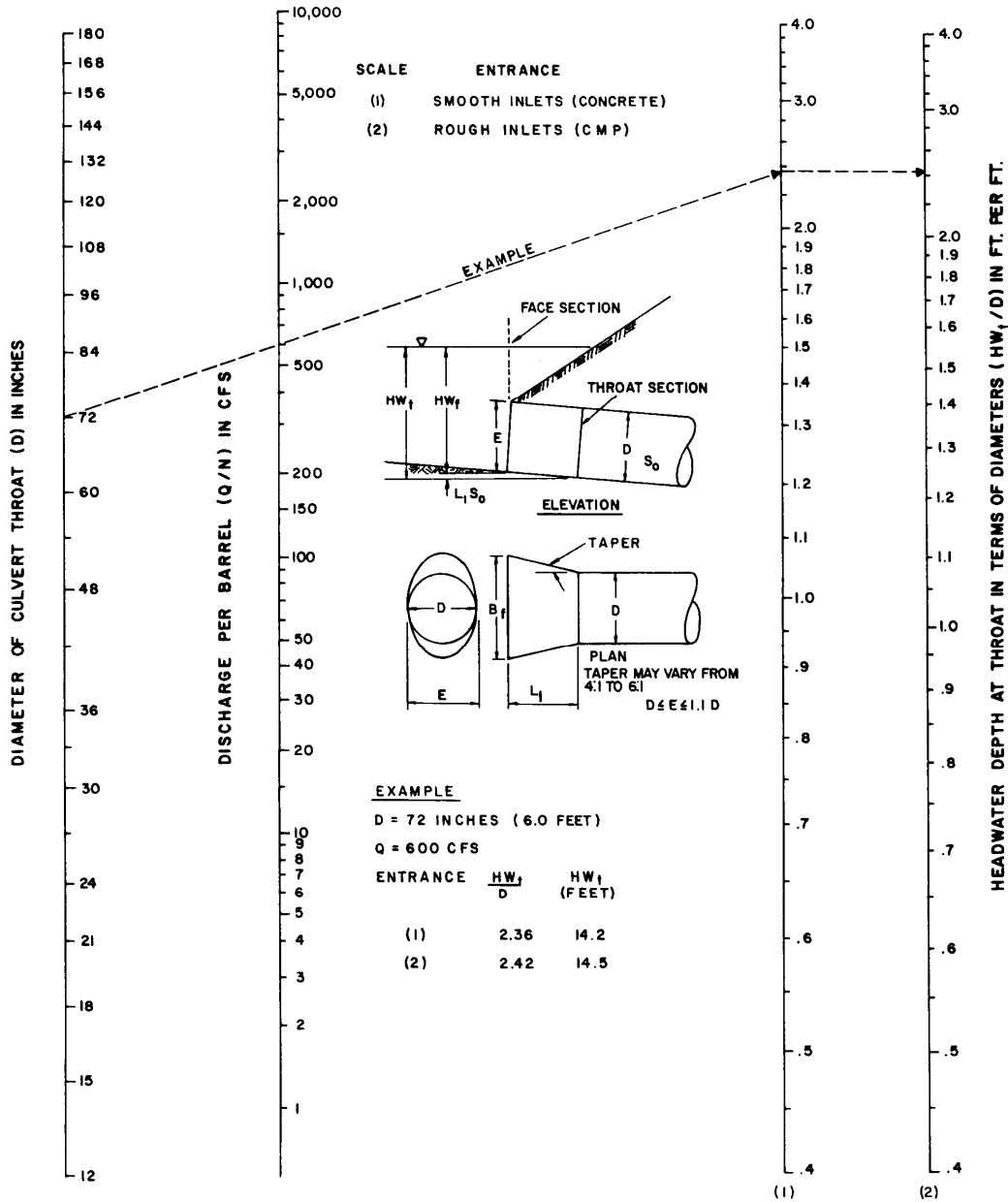
CHART 53



Source: HDS-5

Chart 8C-55 Throat Control, Circular Section, Side-Tapered

CHART 55

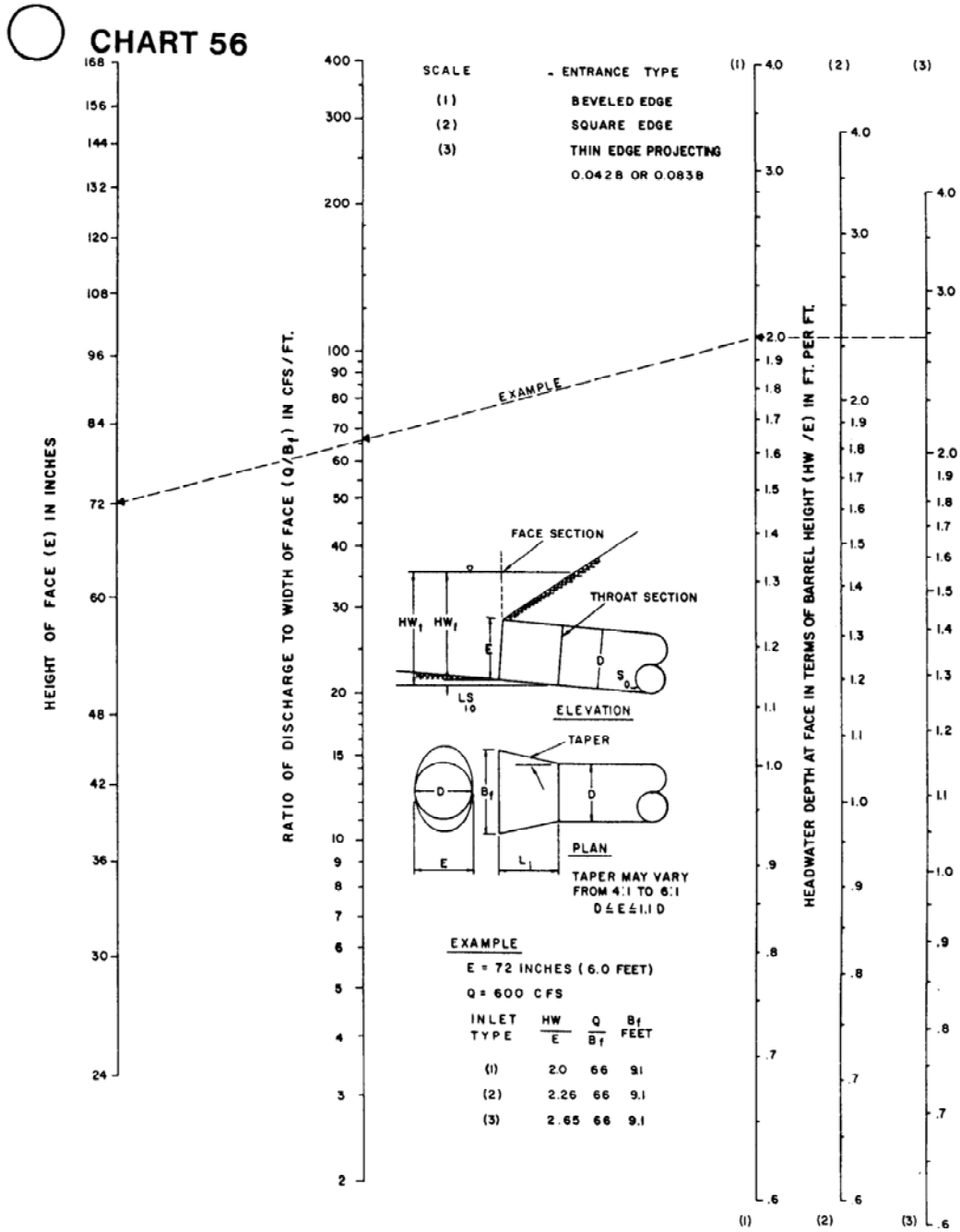


THROAT CONTROL FOR SIDE-TAPERED INLETS TO PIPE CULVERT (CIRCULAR SECTION ONLY)

9 - D - 58

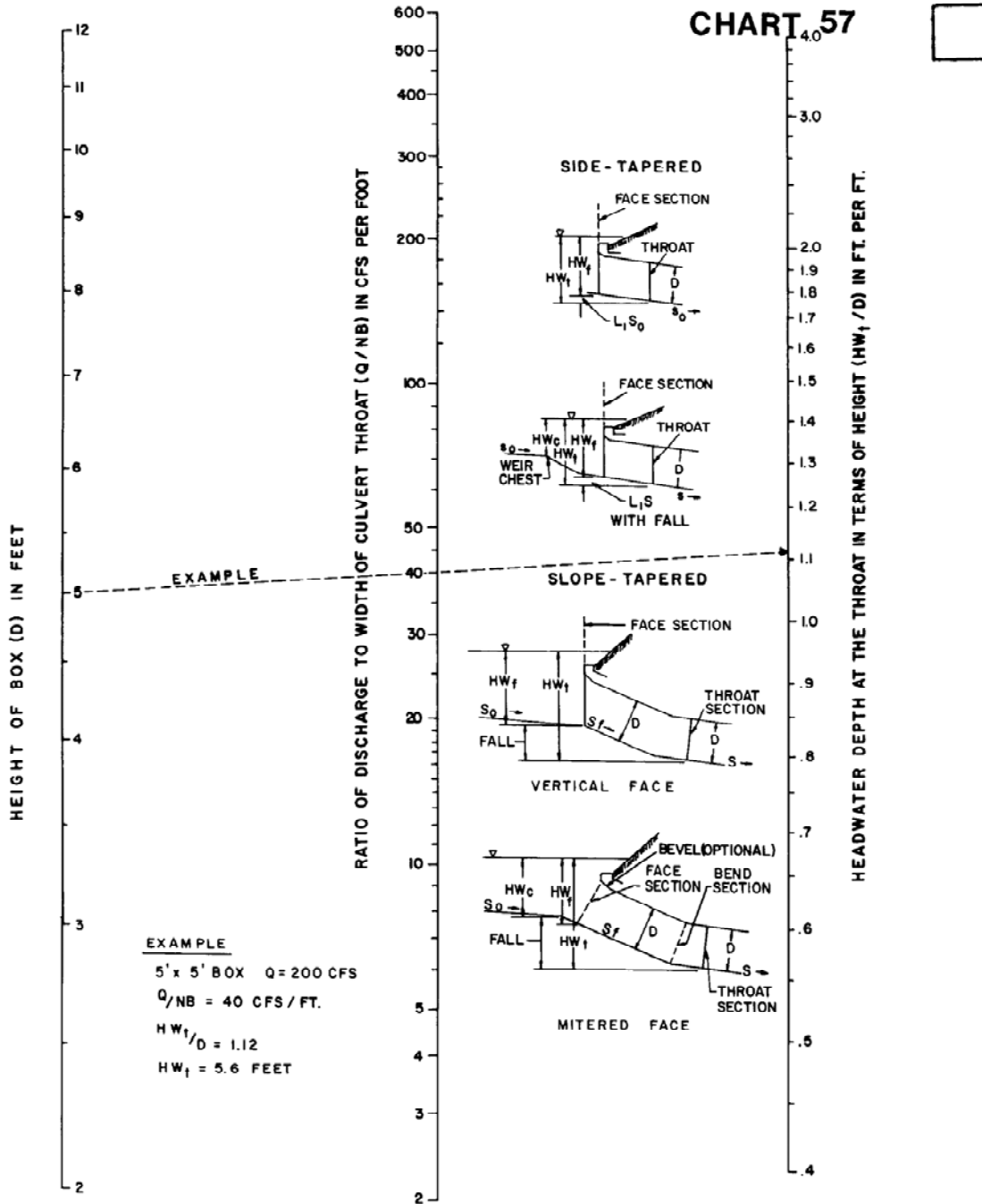
Source: HDS-5

Chart 8C-56 Face Control, Non-Rectangular Section, Side-Tapered to Circular



FACE CONTROL FOR SIDE-TAPERED INLETS TO PIPE CULVERTS (NON-RECTANGULAR SECTIONS ONLY)

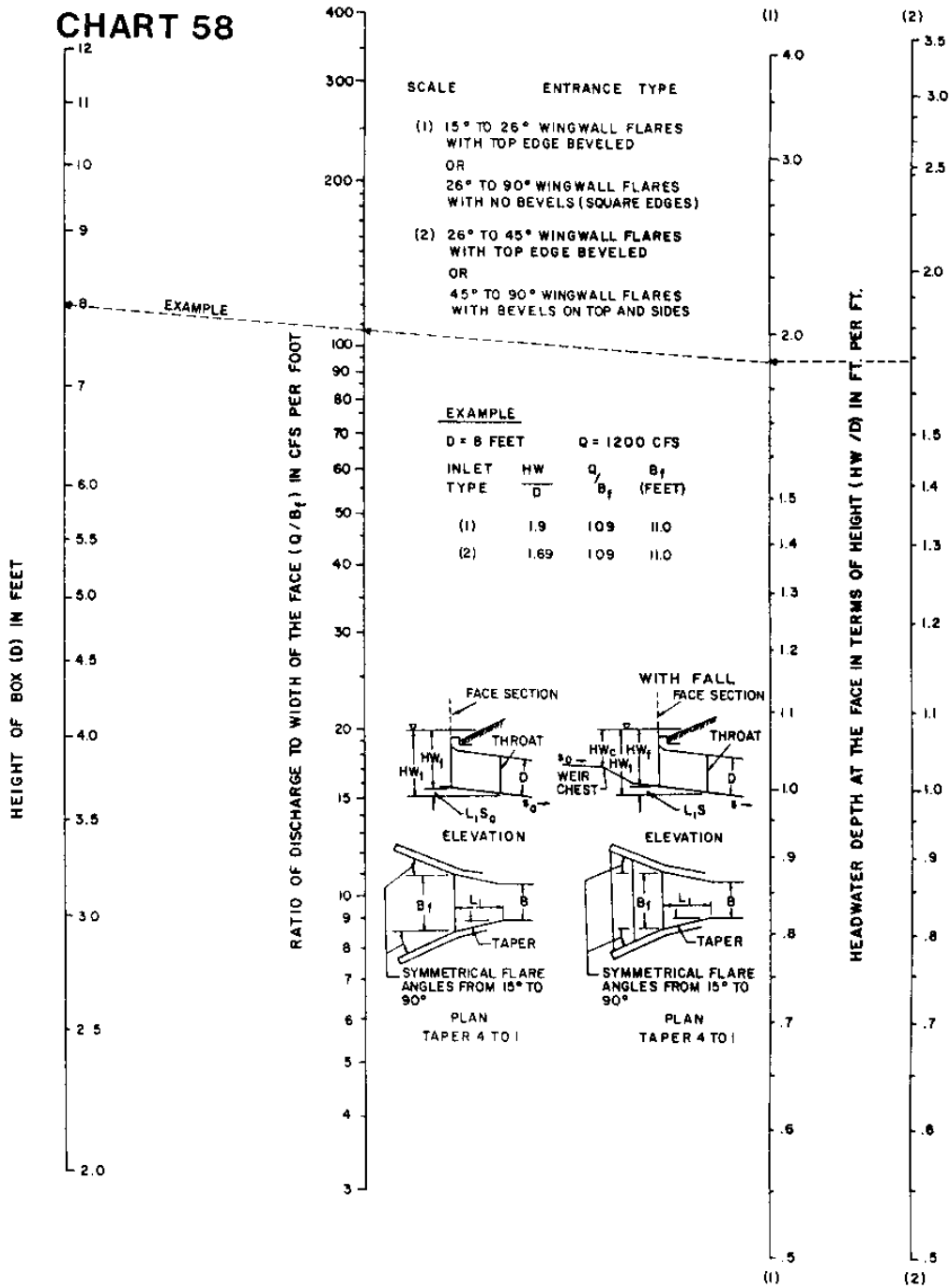
Chart 8C-57 Throat Control, Box Section, Tapered Inlet



9 - D - 60

Source: HDS-5

Appendix 8C-58 Face Control, Box Section, Side-Tapered



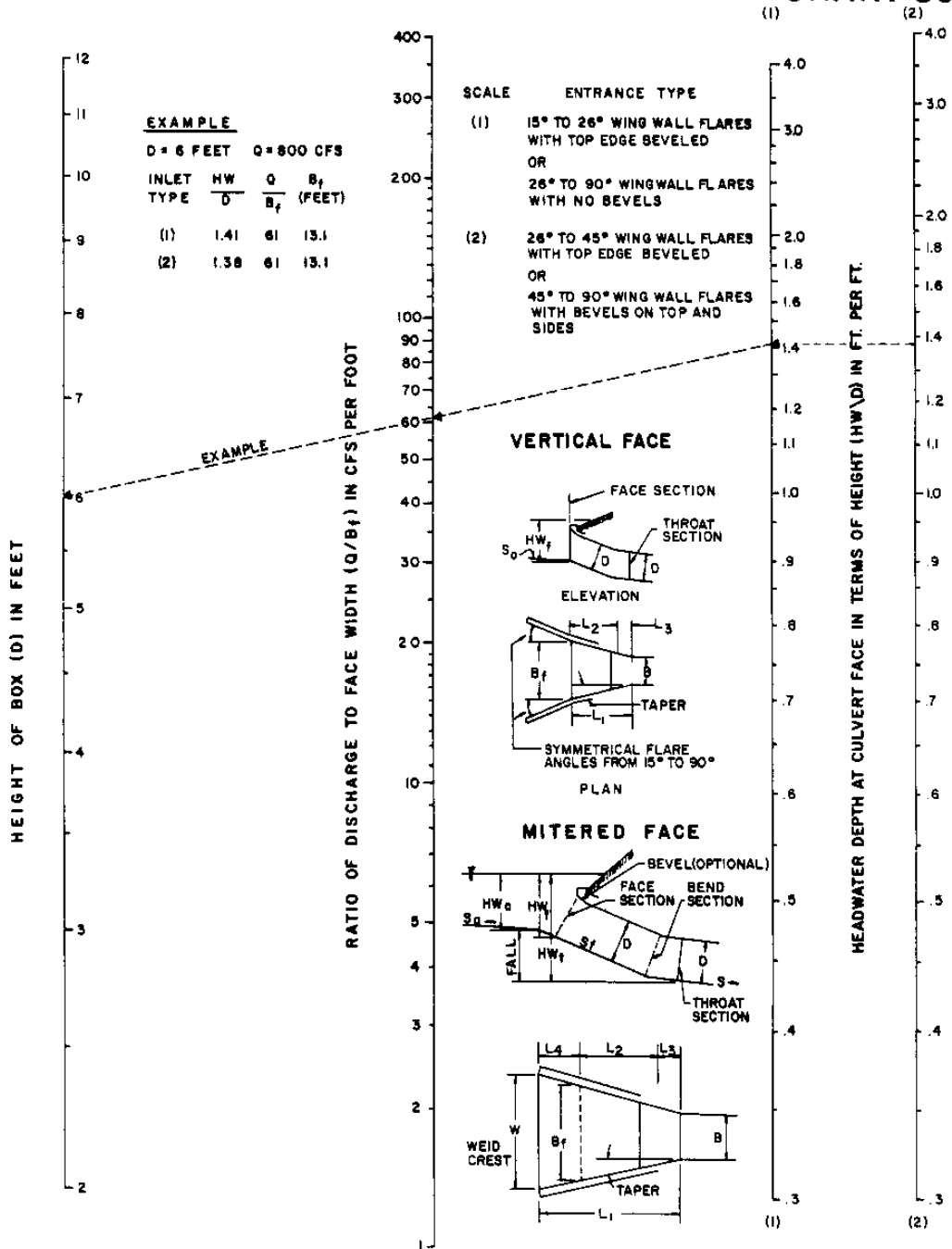
FACE CONTROL FOR BOX CULVERTS WITH SIDE TAPERED INLETS

Source: HDS-5



Appendix 8C-59 Face Control, Box Section, Slope-Tapered

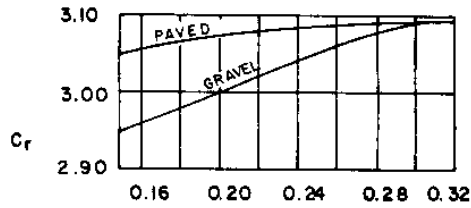
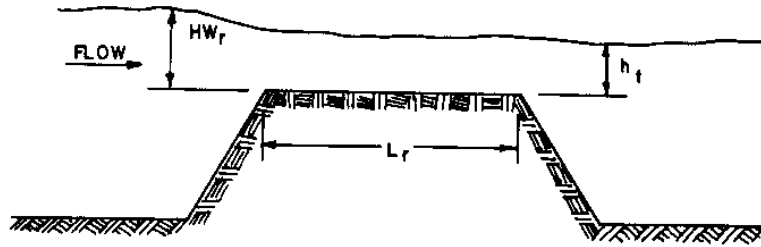
CHART 59



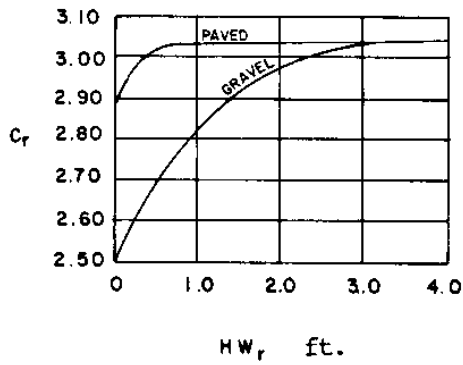
FACE CONTROL FOR BOX  
CULVERTS WITH SLOPE  
TAPERED INLETS

Source: HDS-5

Chart 8C-60 Discharge Coefficients for Roadway Overtopping



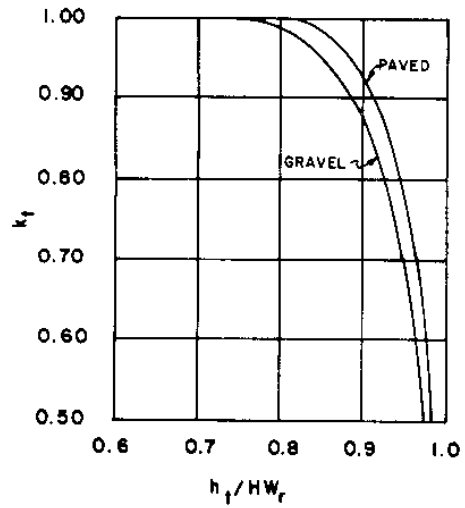
A) DISCHARGE COEFFICIENT FOR  $HW_r/L_r > 0.15$



B) DISCHARGE COEFFICIENT FOR  $HW_r/L_r \leq 0.15$

$$C_d = k_t C_r$$

$$Q_r = C_d L H W_r^{1.5}$$

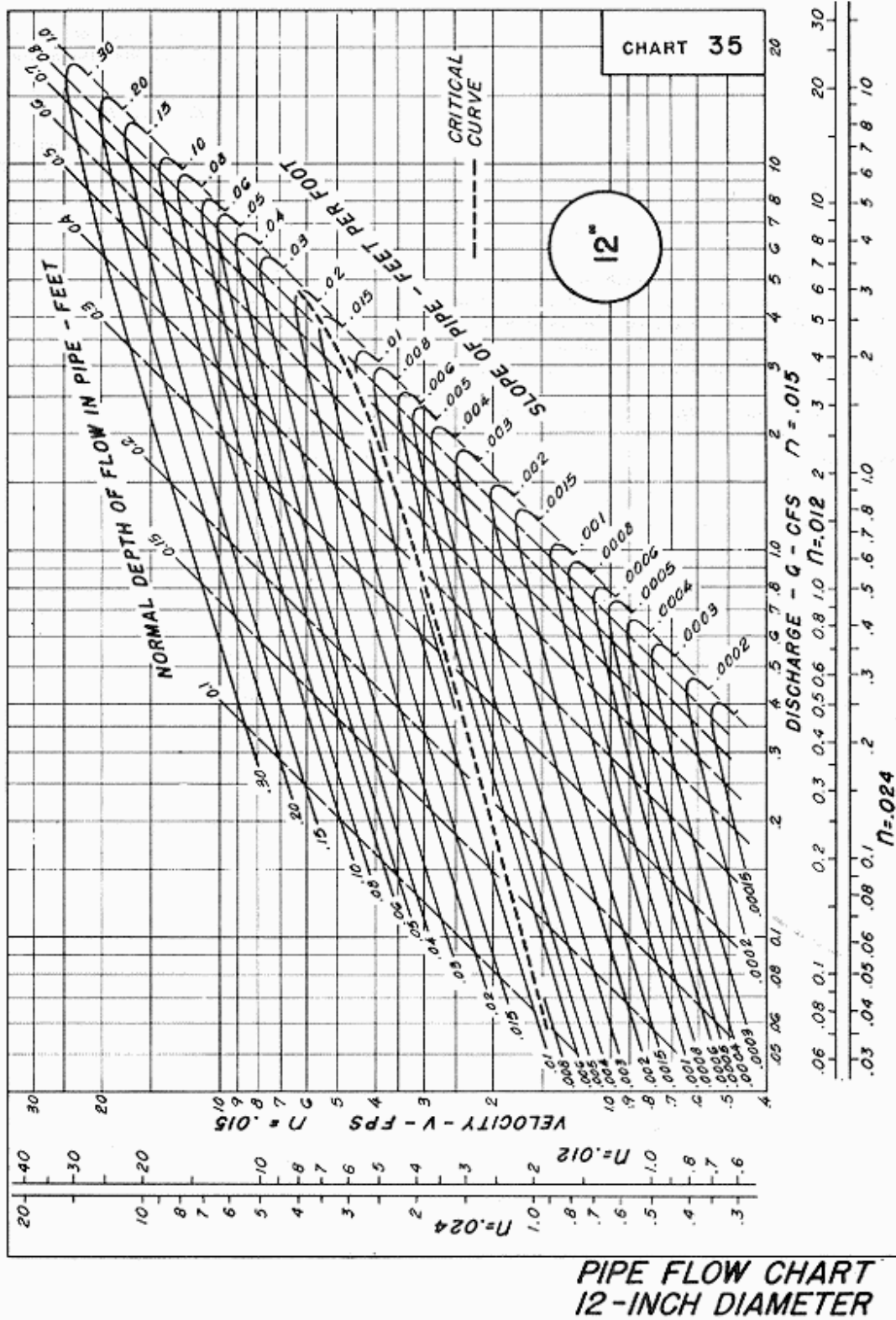


C) SUBMERGENCE FACTOR

DISCHARGE COEFFICIENTS  
FOR ROADWAY OVERTOPPING

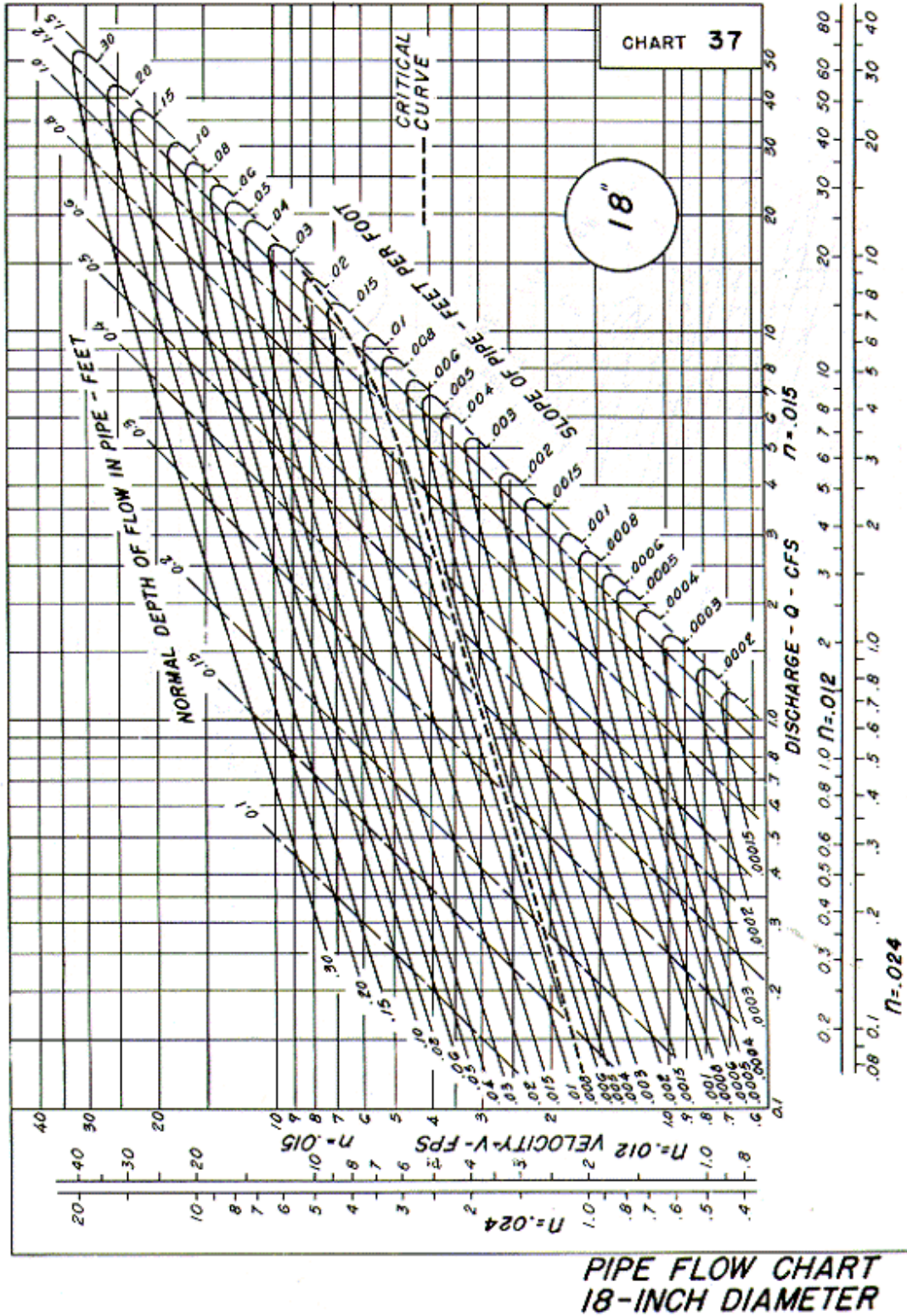
Source: HDS-5

Appendix 8C-61 Circular Pipe Flow Chart (Diameter = 12")



Source: HDS-3

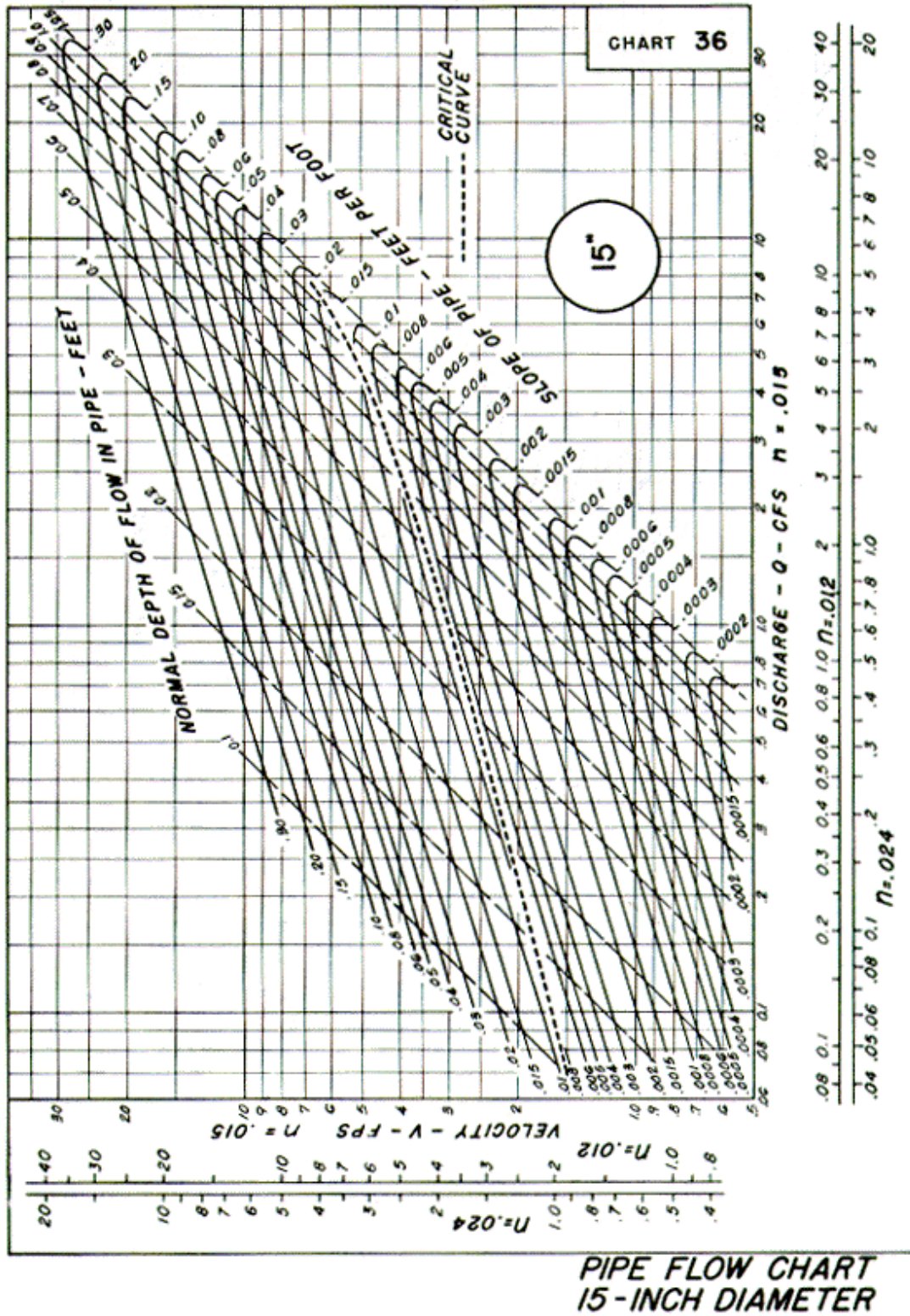
Appendix 8C-63 Circular Pipe Flow Chart (Diameter = 18")



Source: HDS-3

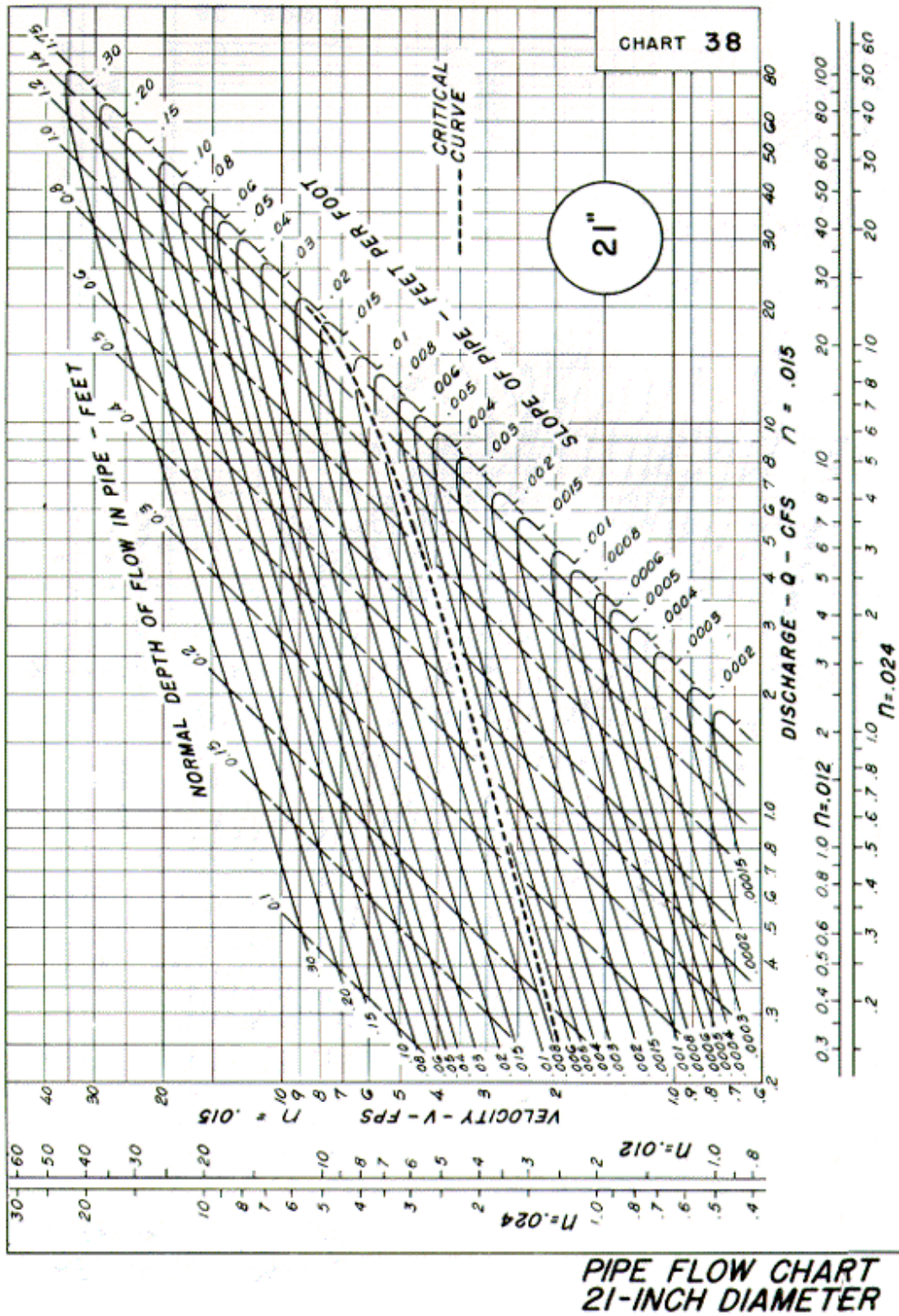


Appendix 8C-62 Circular Pipe Flow Chart (Diameter = 15")



Source: HDS-3

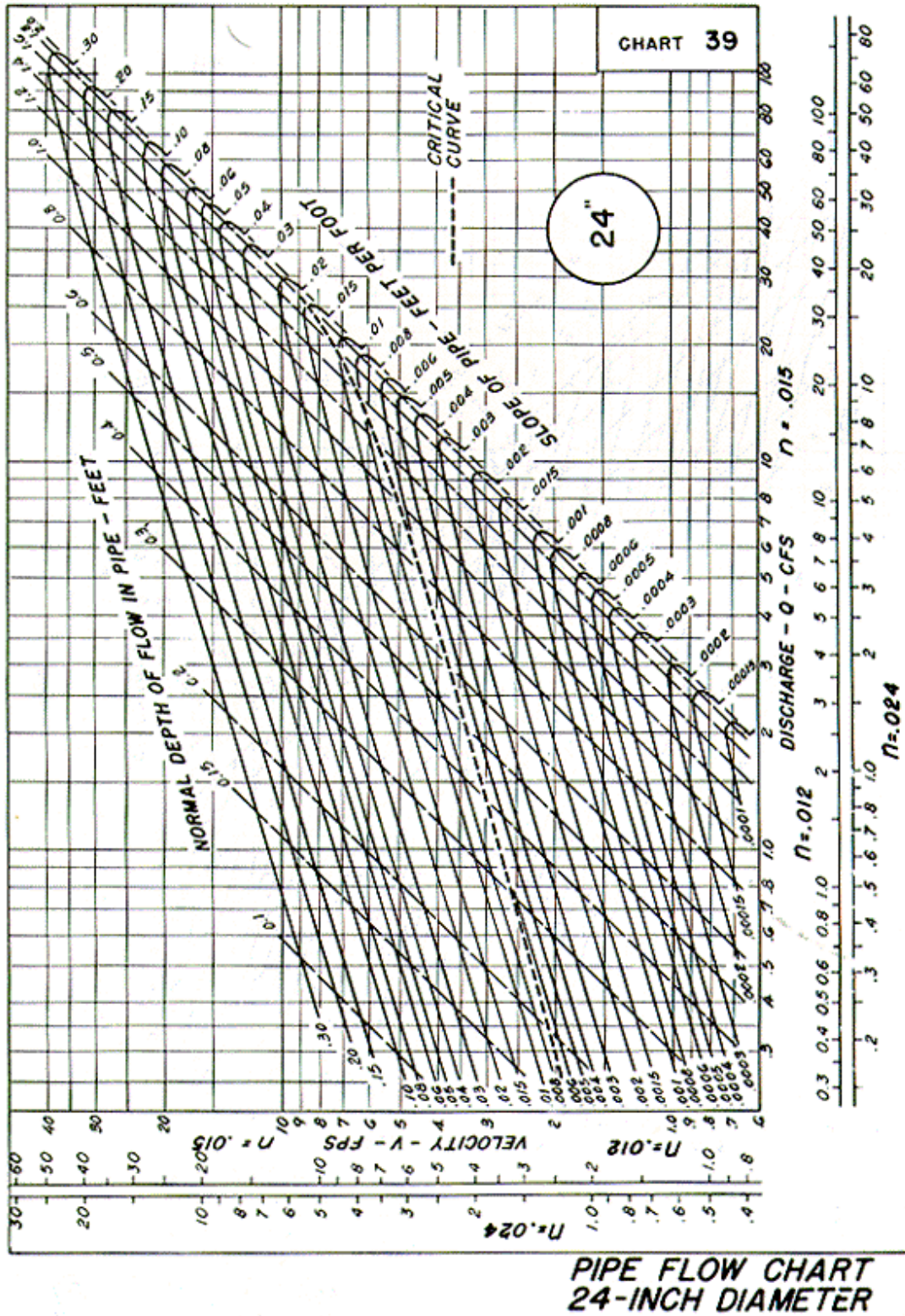
Appendix 8C-64 Circular Pipe Flow Chart (Diameter = 21")



Source: HDS-3

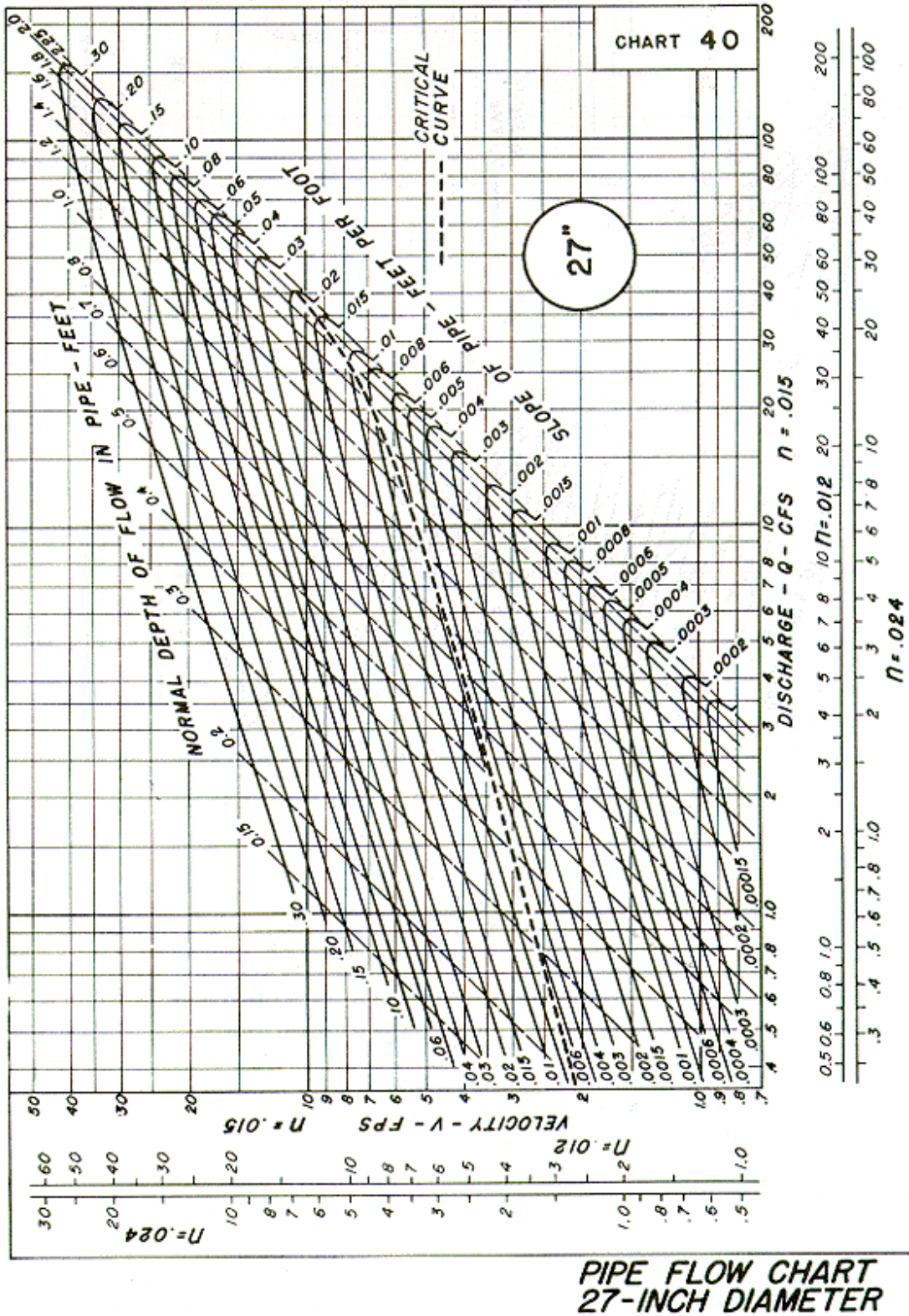


Appendix 8C-65 Circular Pipe Flow Chart (Diameter = 24")



Source: HDS-3

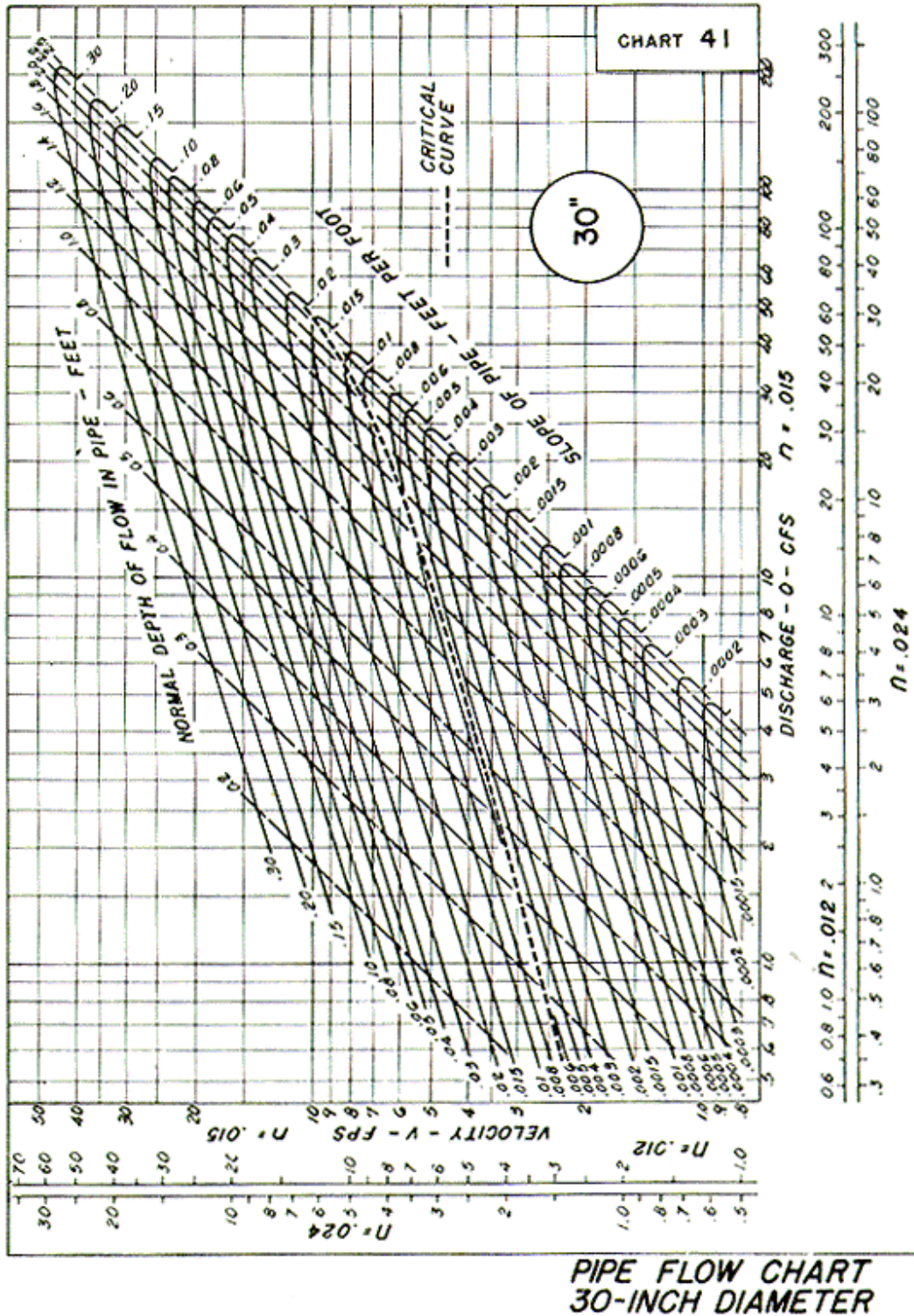
Appendix 8C-66 Circular Pipe Flow Chart (Diameter = 27")



Source: HDS-3



Appendix 8C-67 Circular Pipe Flow Chart (Diameter = 30")

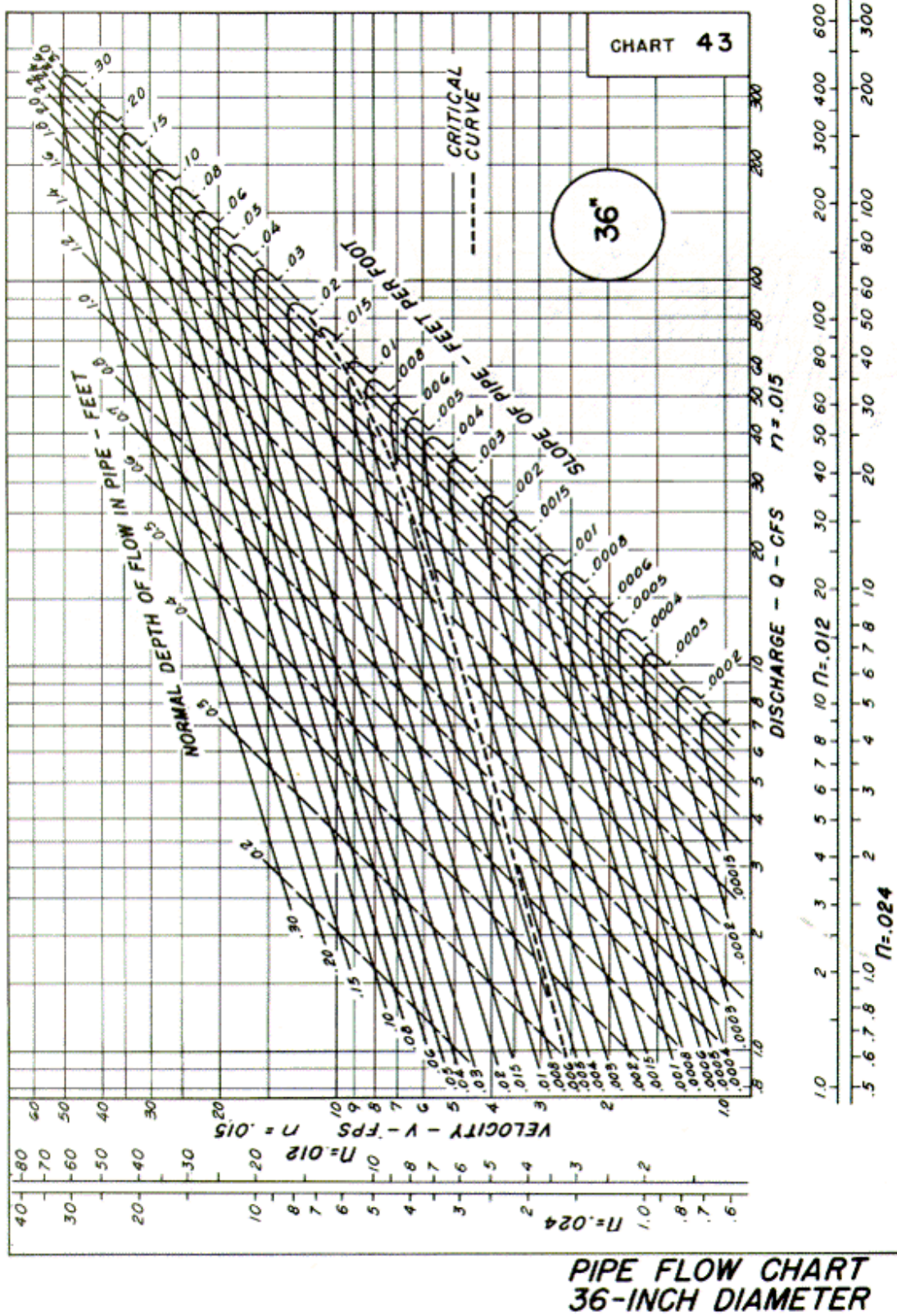


Source: HDS-3



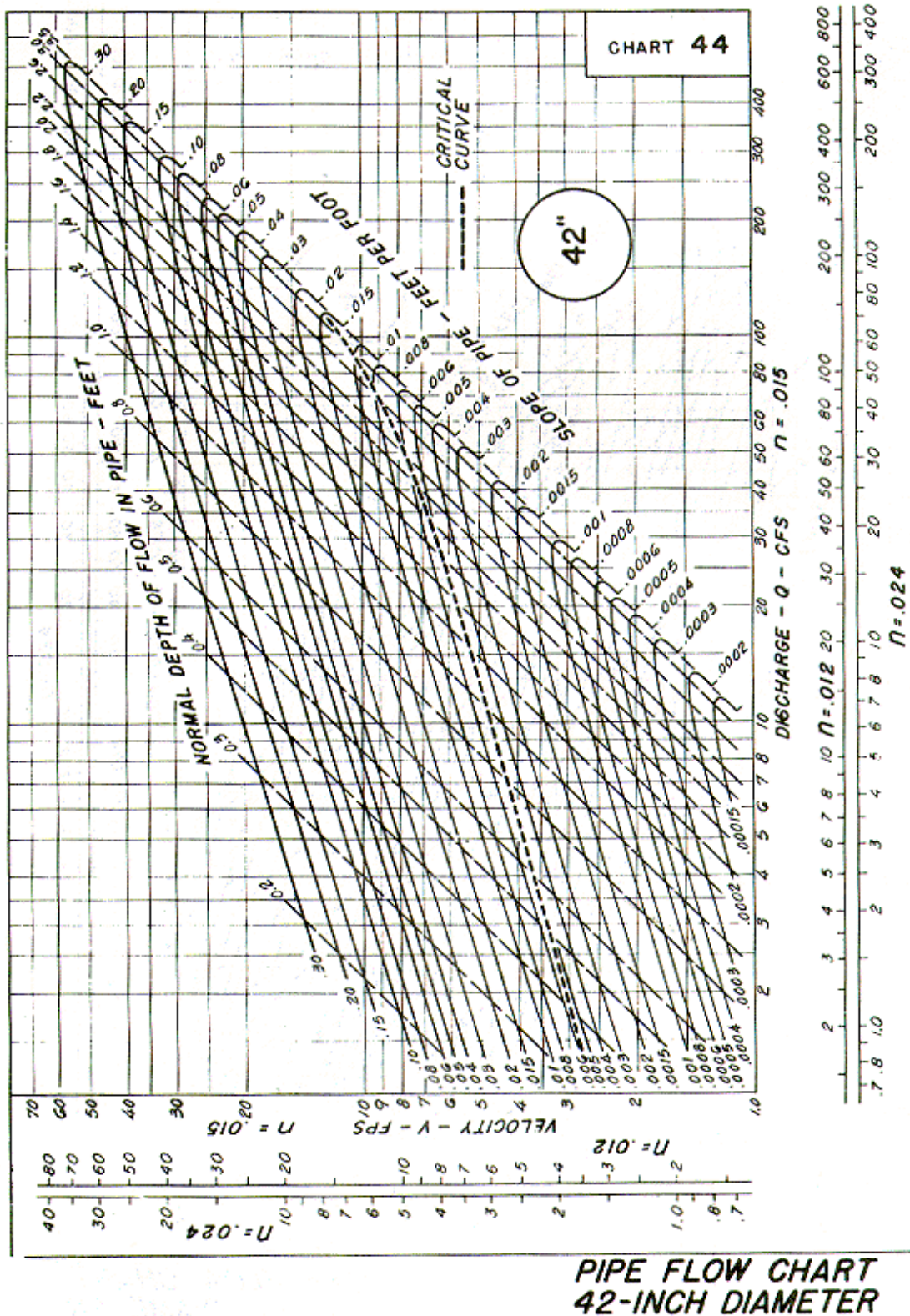


Appendix 8C-69 Circular Pipe Flow Chart (Diameter = 36")



Source: HDS-3

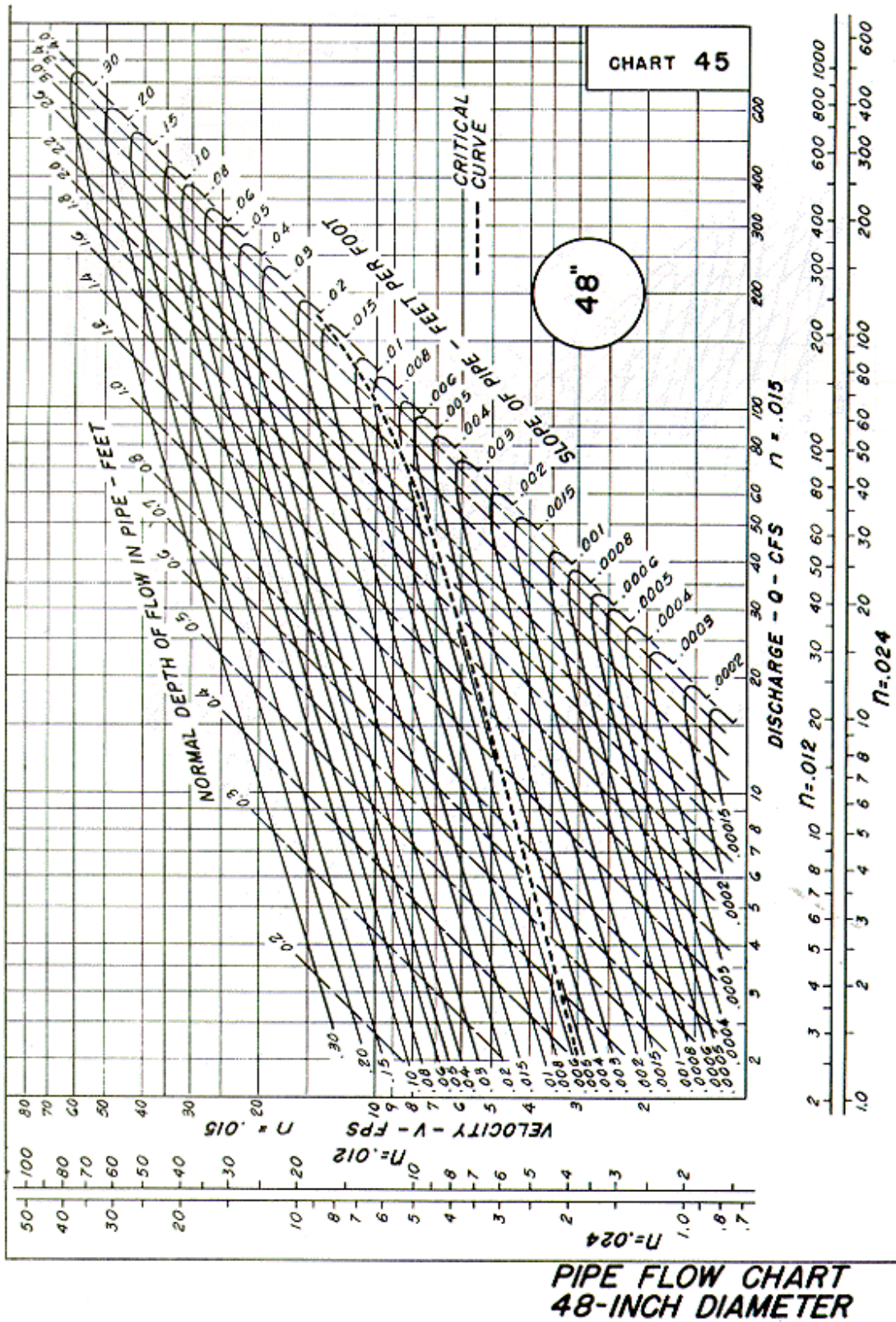
Appendix 8C-70 Circular Pipe Flow Chart (Diameter = 42")



Source: HDS-3

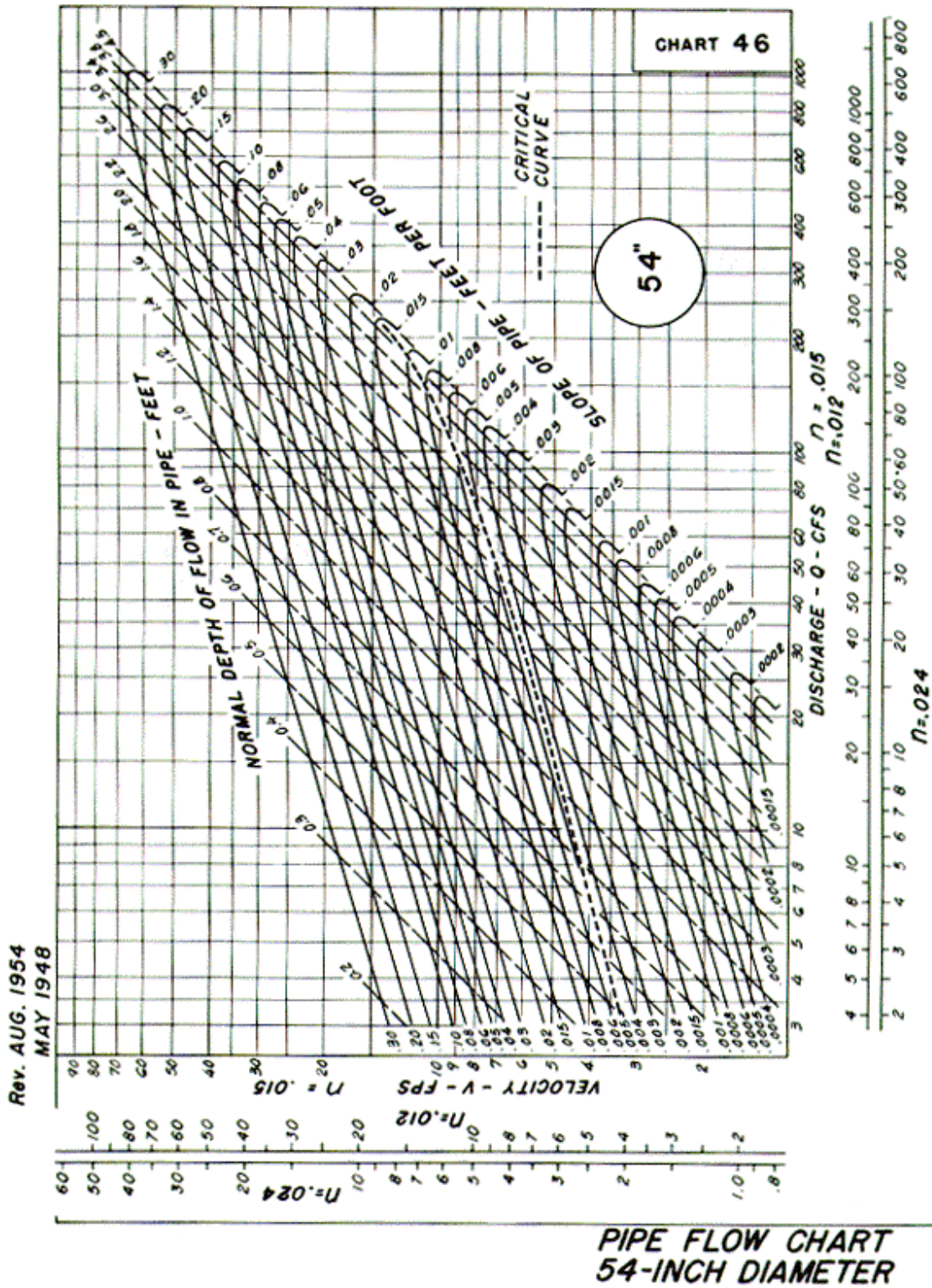


Appendix 8C-71 Circular Pipe Flow Chart (Diameter 48")



Source: HDS-3

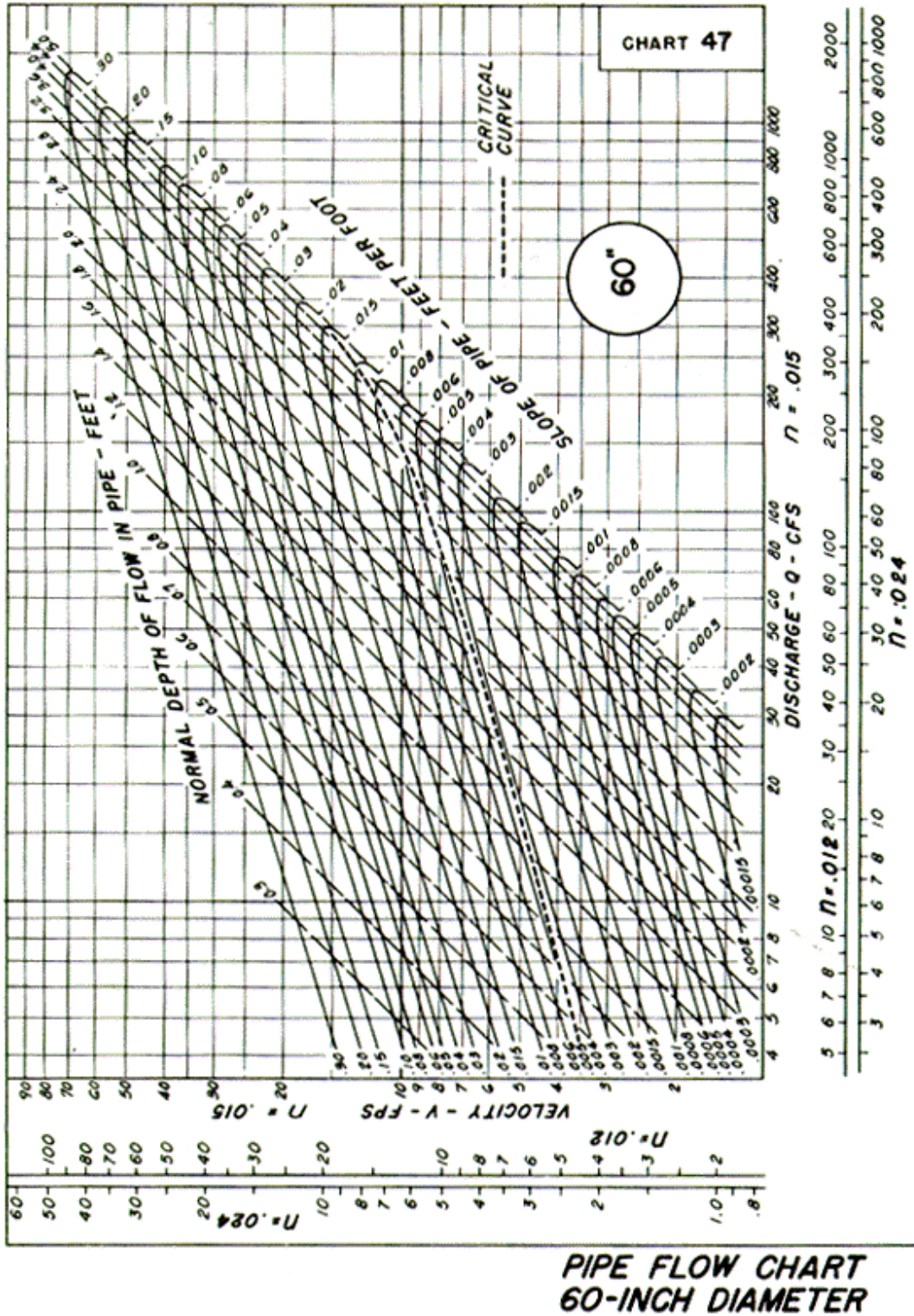
Appendix 8C-72 Circular Pipe Flow Chart (Diameter = 54")



Source: HDS-3

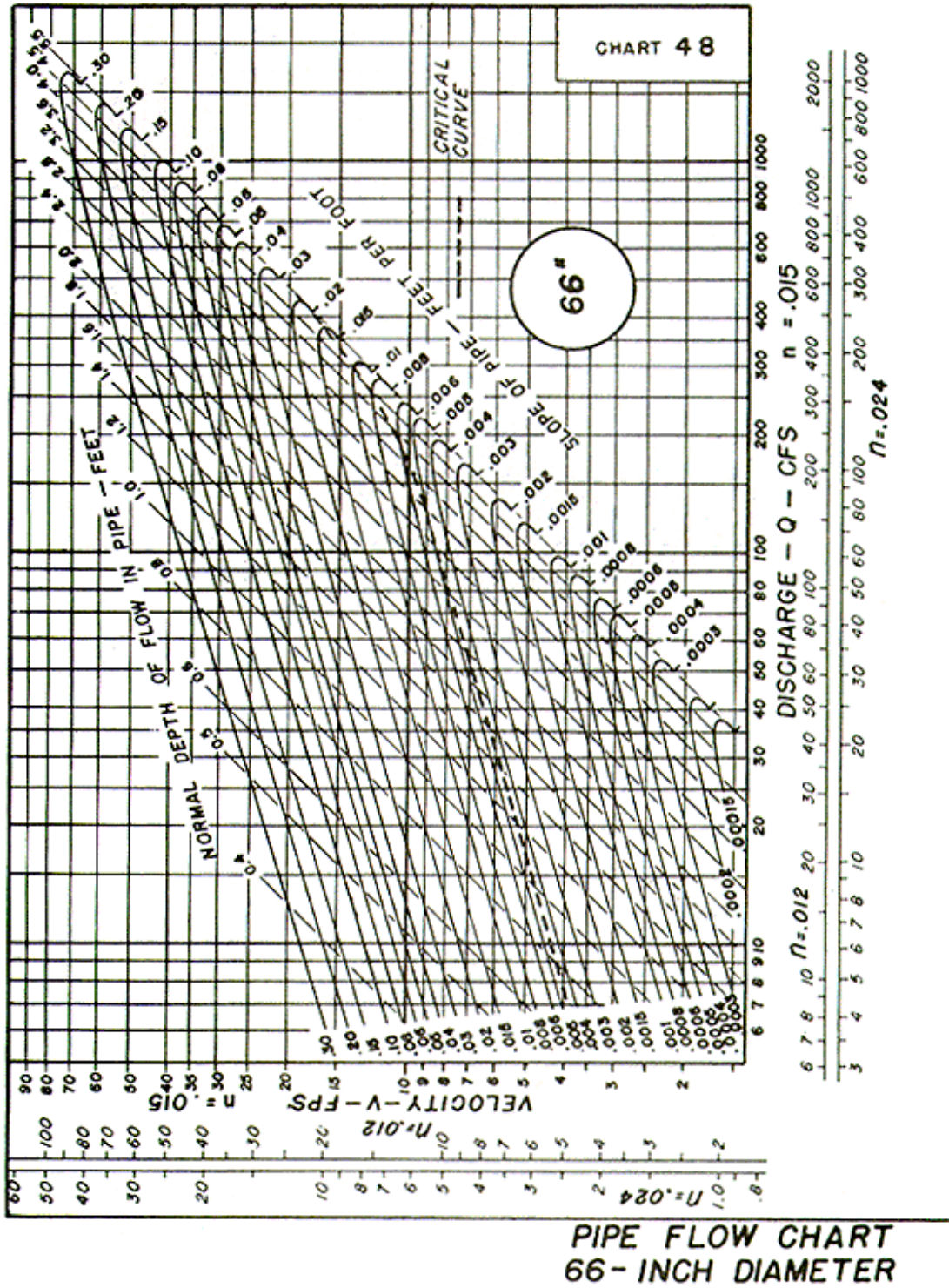


Appendix 8C-73 Circular Pipe Flow Chart (Diameter = 60")



Source: HDS-3

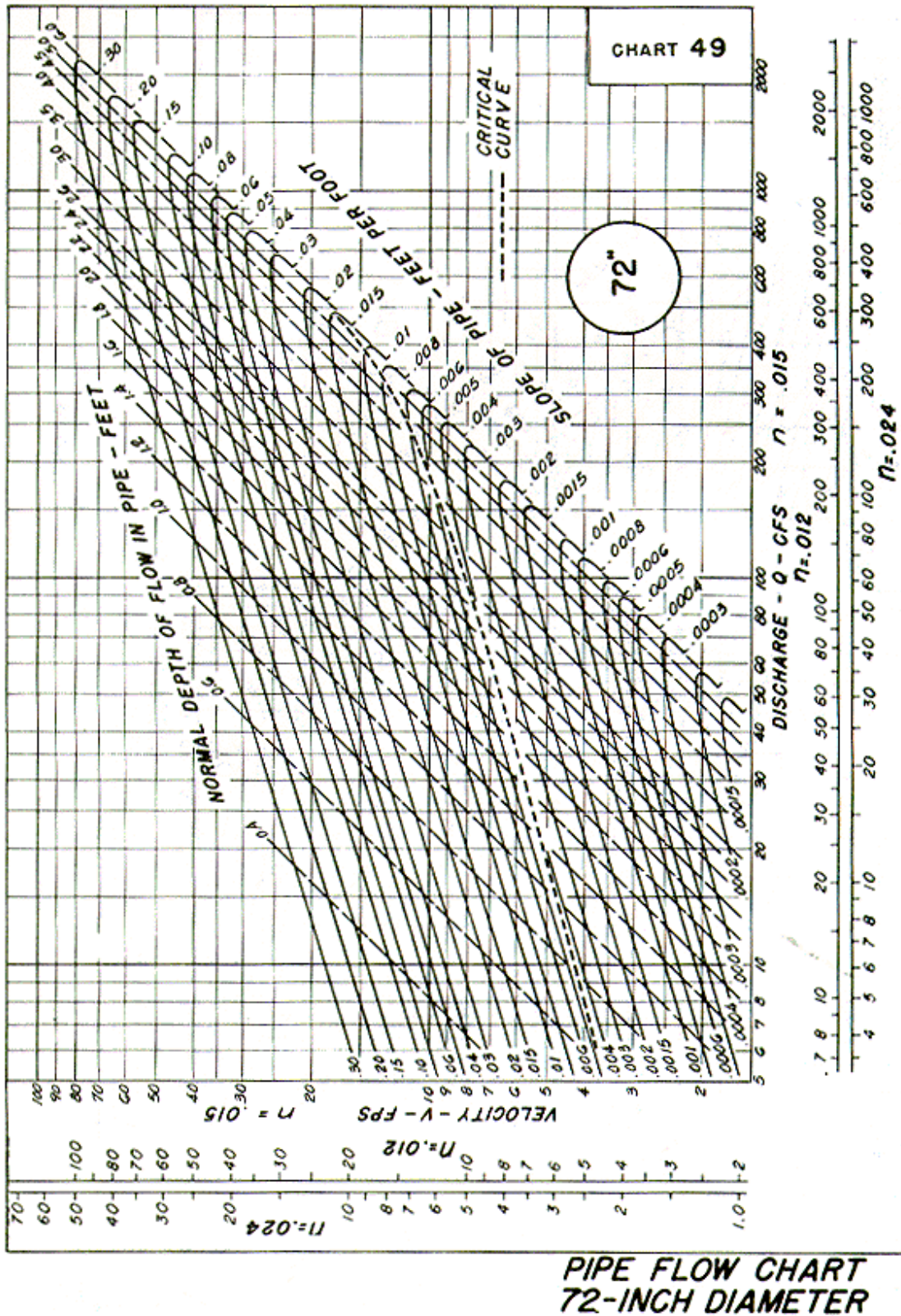
Appendix 8C-74 Circular Pipe Flow Chart (Diameter = 66")



Source: HDS-3

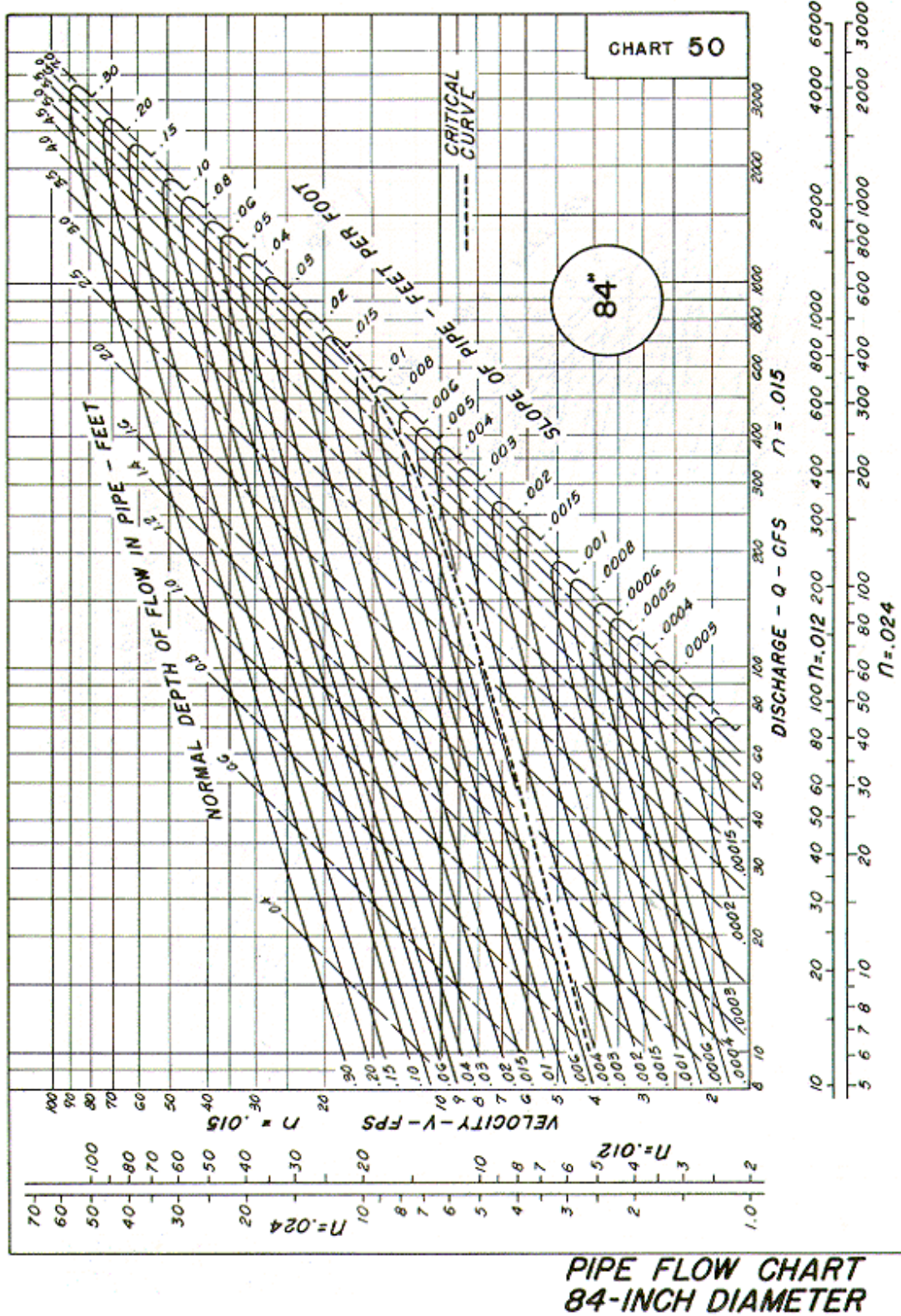


Appendix 8C-75 Circular Pipe Flow Chart (Diameter = 72")



Source: HDS-3

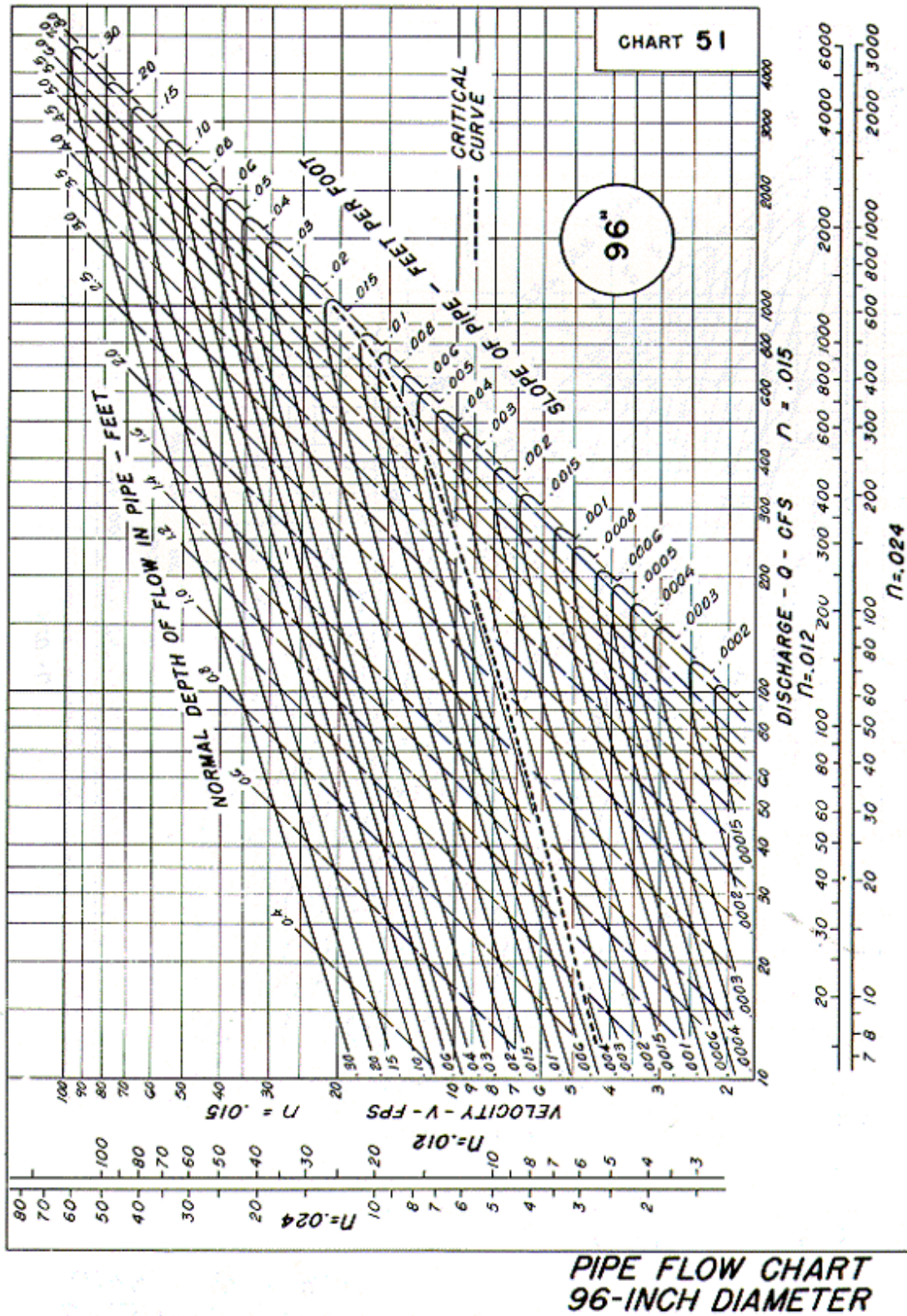
Appendix 8C-76 Circular Pipe Flow Chart (Diameter = 84")



Source: HDS-3

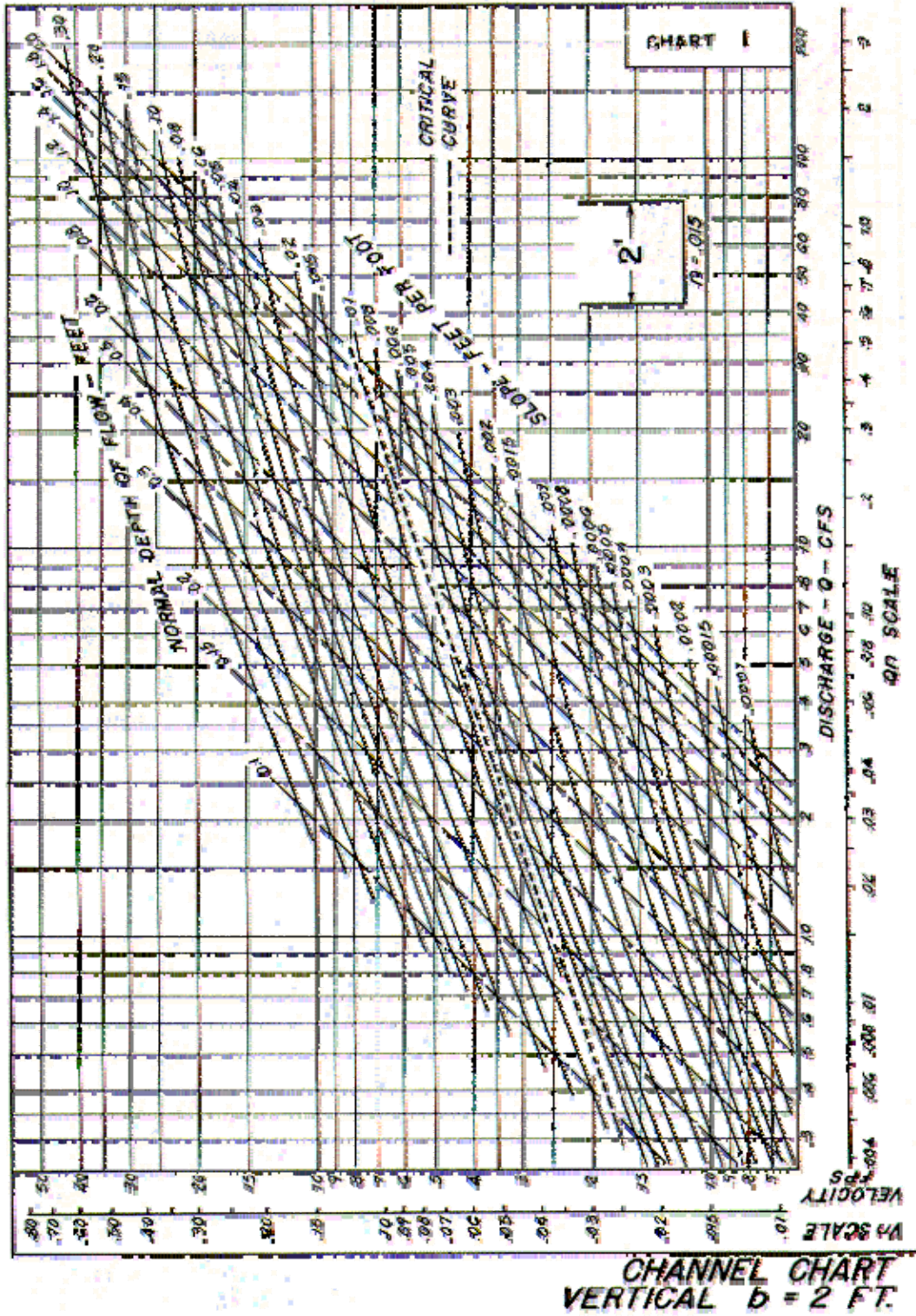


Appendix 8C-77 Circular Pipe Flow Chart (Diameter = 96")



Source: HDS-3

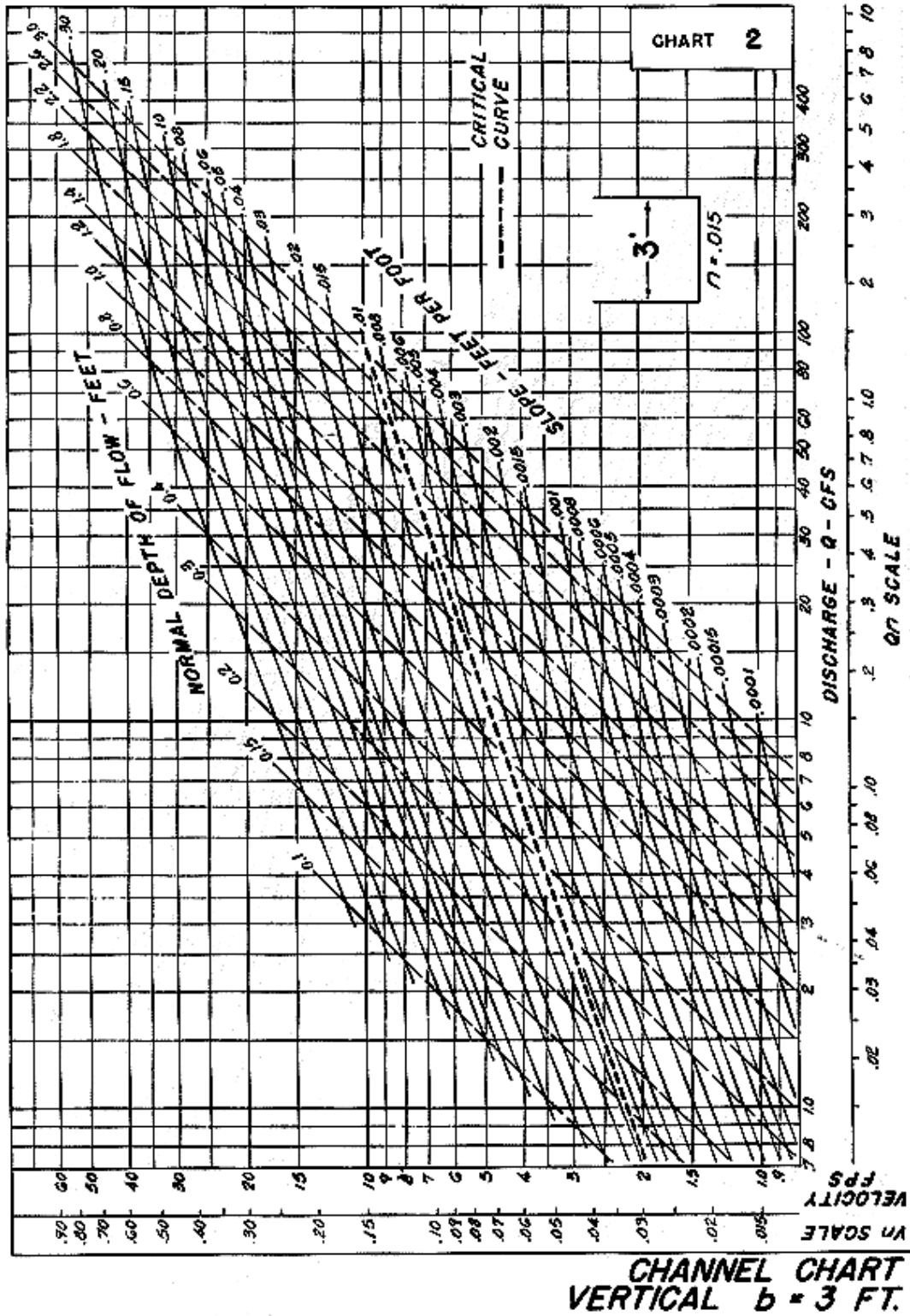
Appendix 8C-78 Rectangular Channel Flow Chart (B=2')



Source: HDS-3

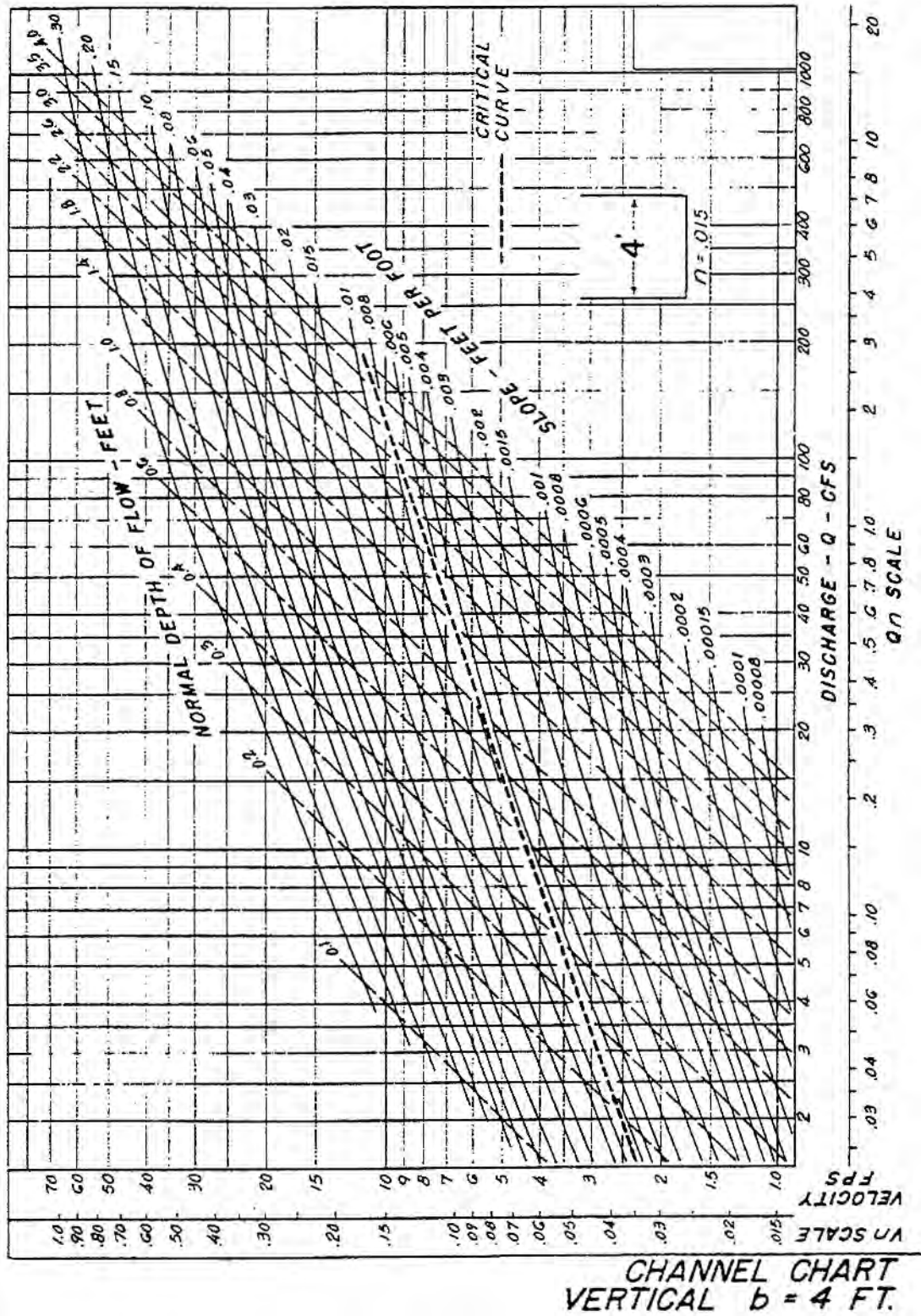


Appendix 8C-79 Rectangular Channel Flow Chart (B=3')



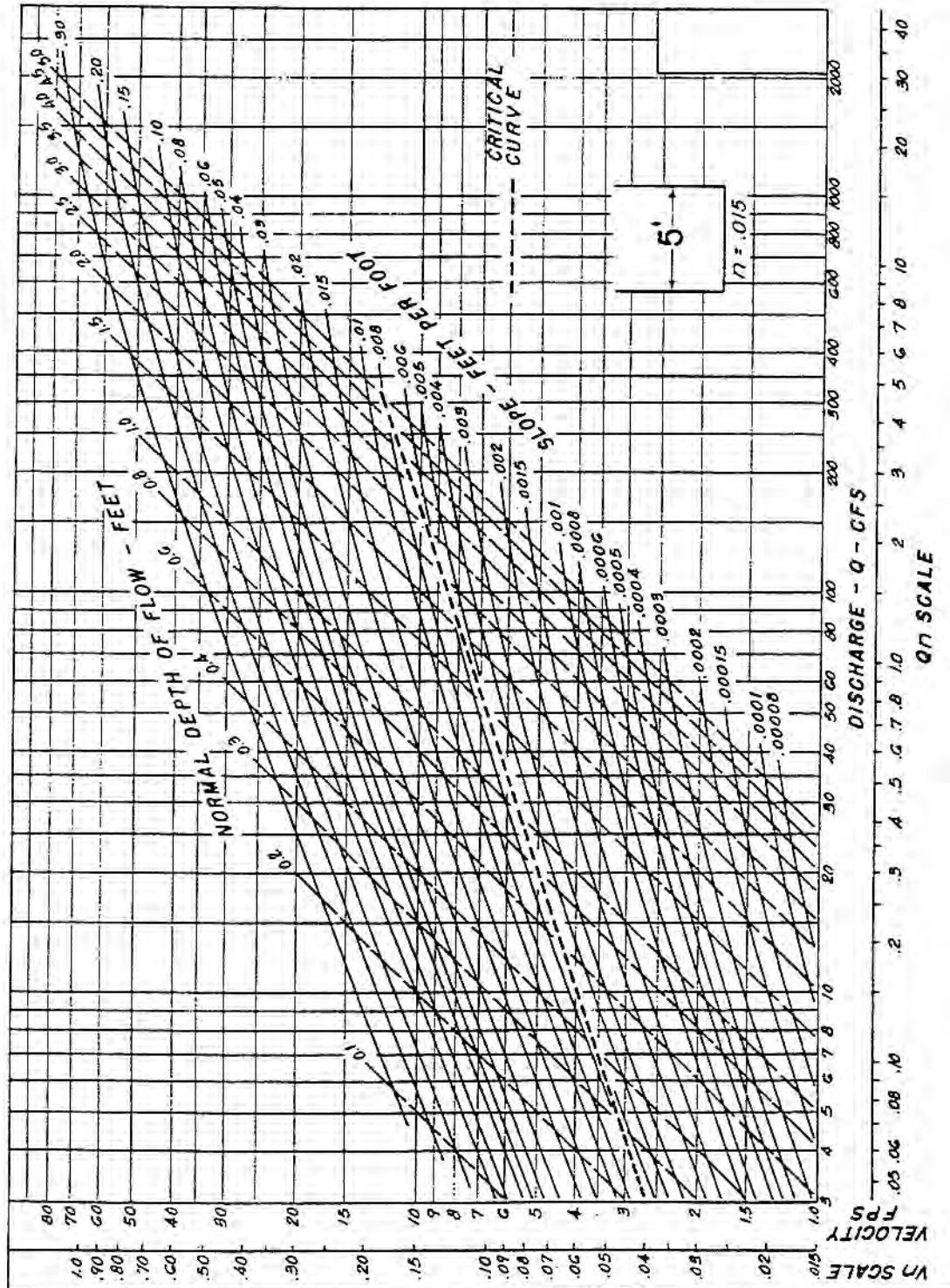
Source: HDS-3

Appendix 8C-80 Rectangular Channel Flow Chart (B=4')



Source: HDS-3

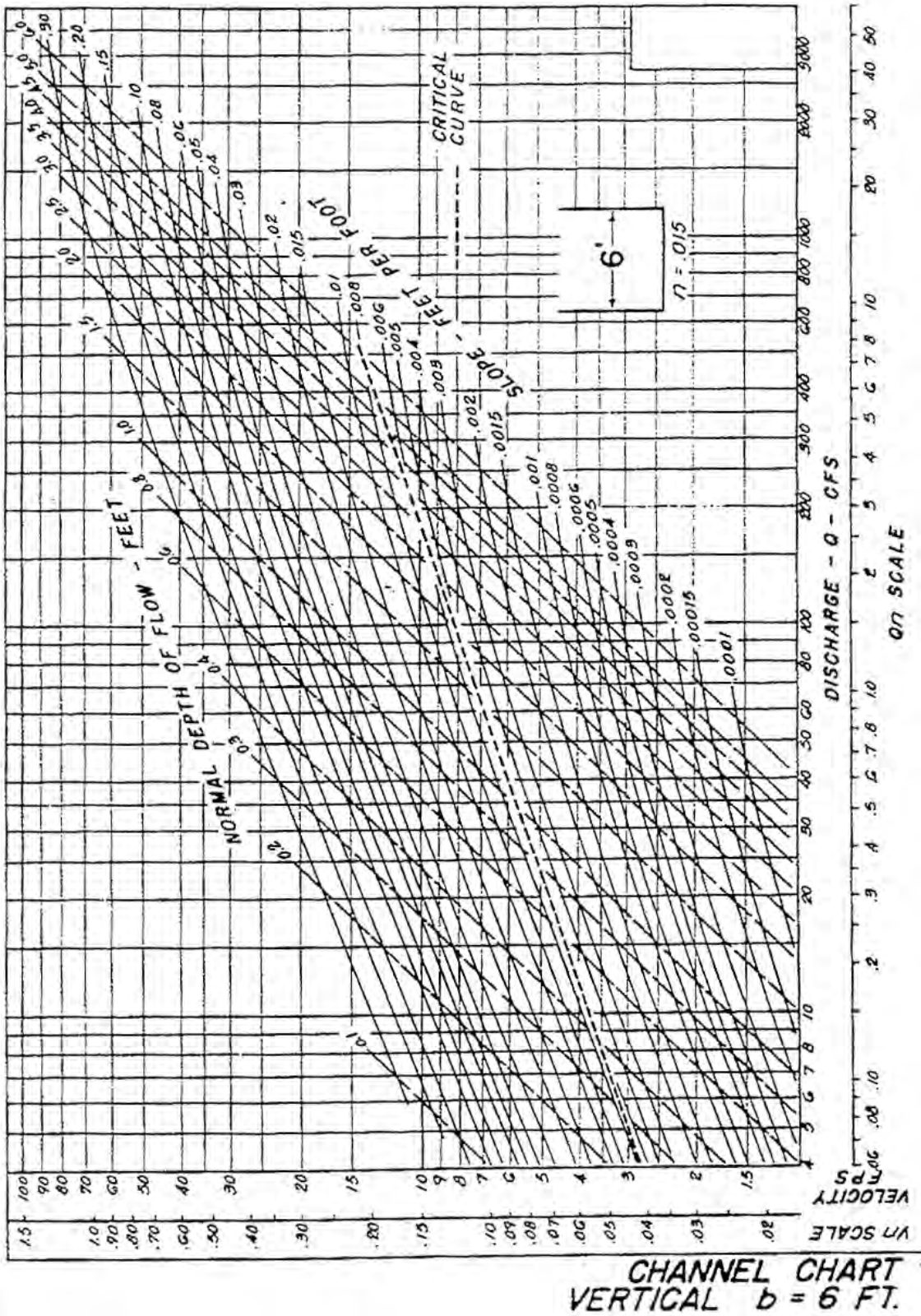
Appendix 8C-81 Rectangular Channel Flow Chart (B=5')



CHANNEL CHART  
VERTICAL  $b = 5$  FT.

Source: HDS-3

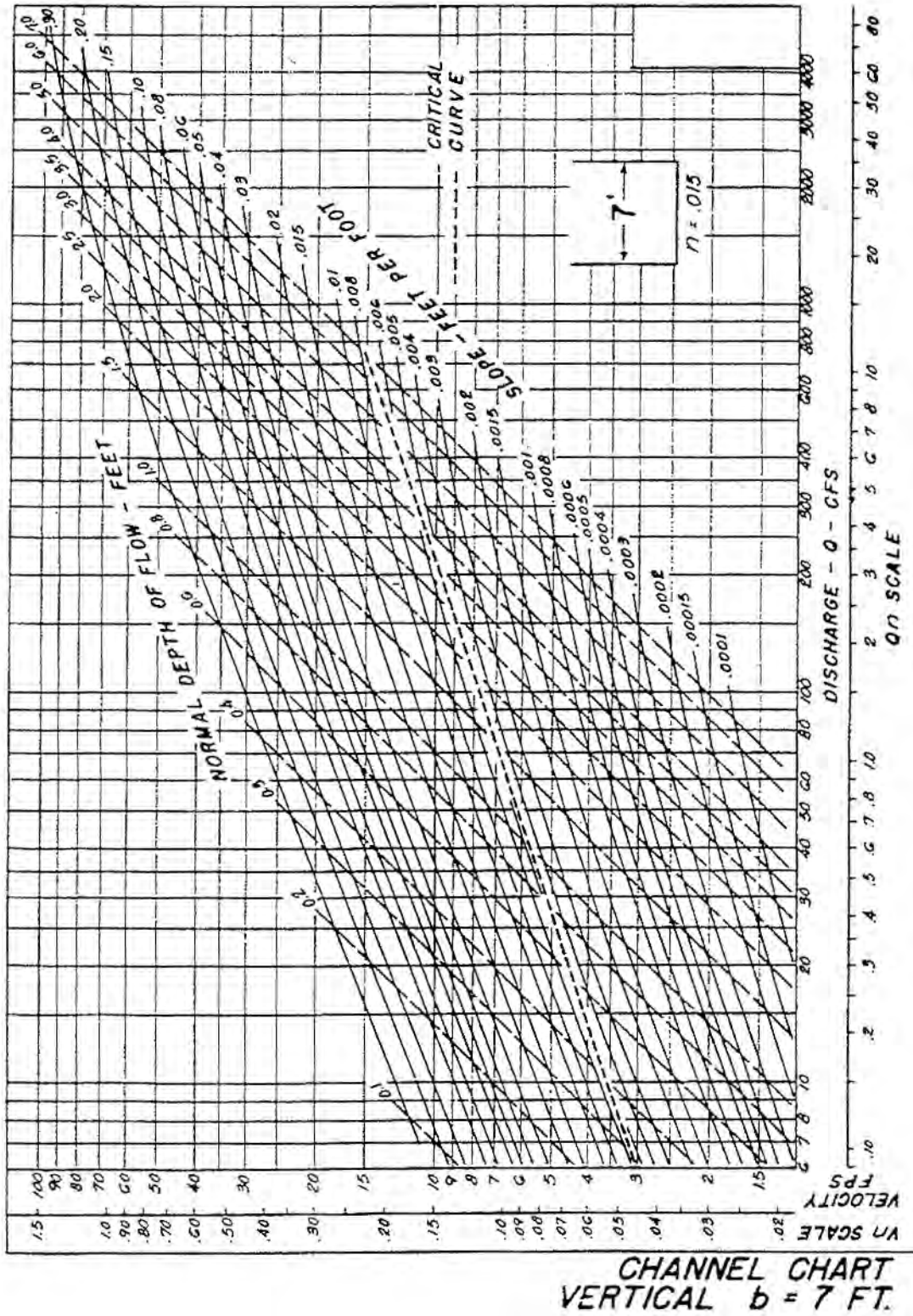
Appendix 8C-82 Rectangular Channel Flow Chart (B=6')



Source: HDS-3

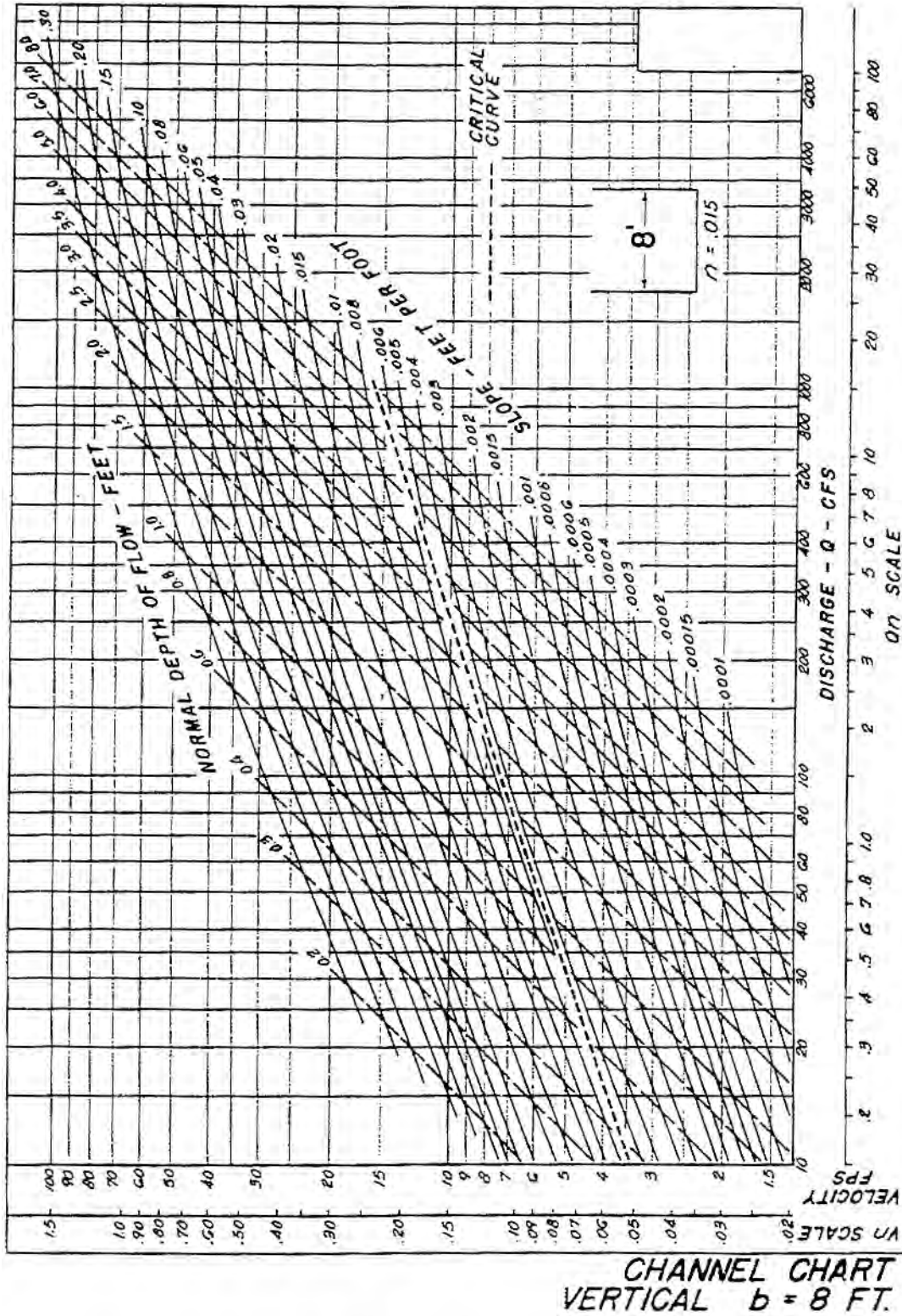


Appendix 8C-83 Rectangular Channel Flow Chart (B=7')



Source: HDS-3

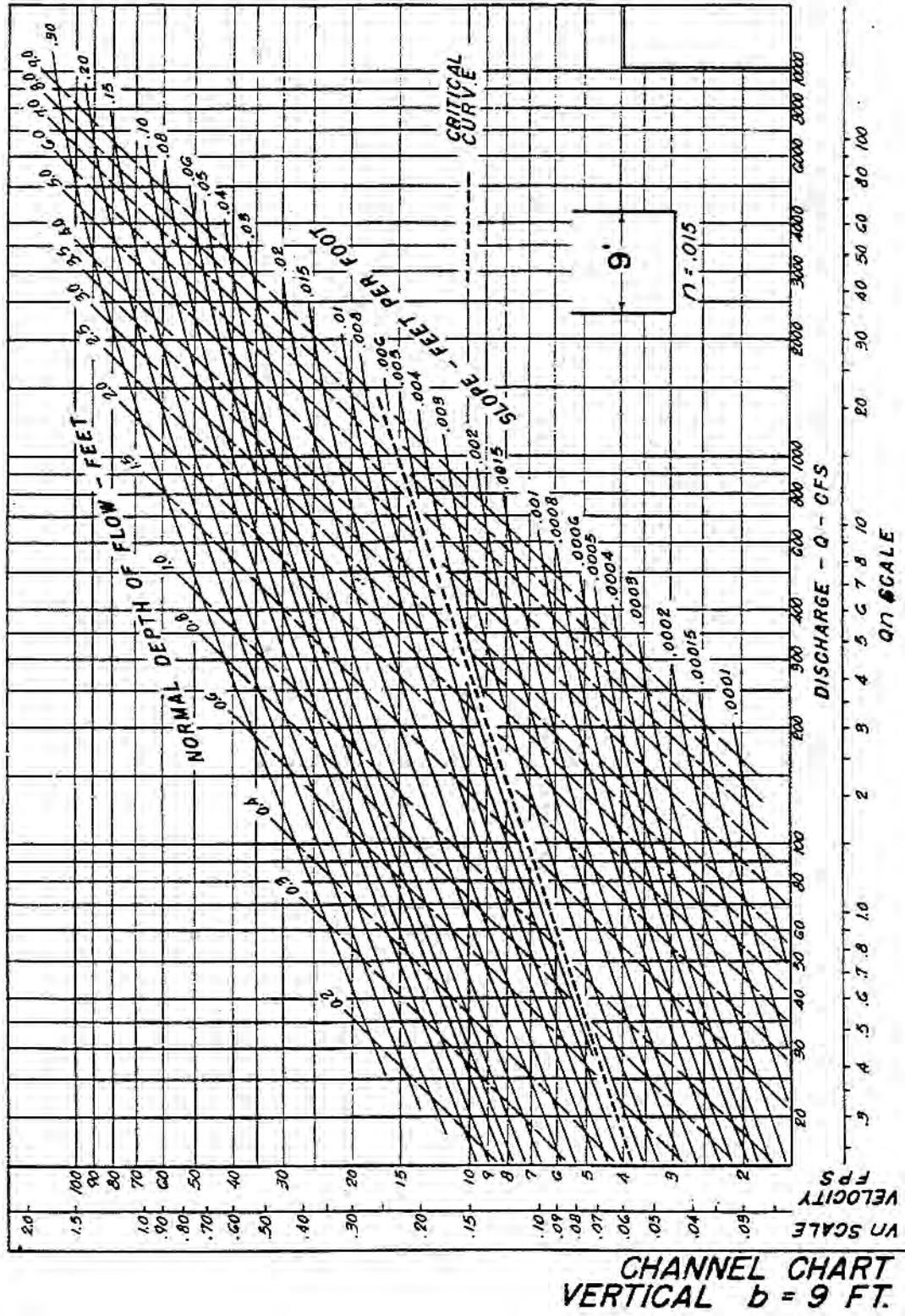
Appendix 8C-84 Rectangular Channel Flow Chart (B=8')



CHANNEL CHART  
VERTICAL  $b = 8$  FT.

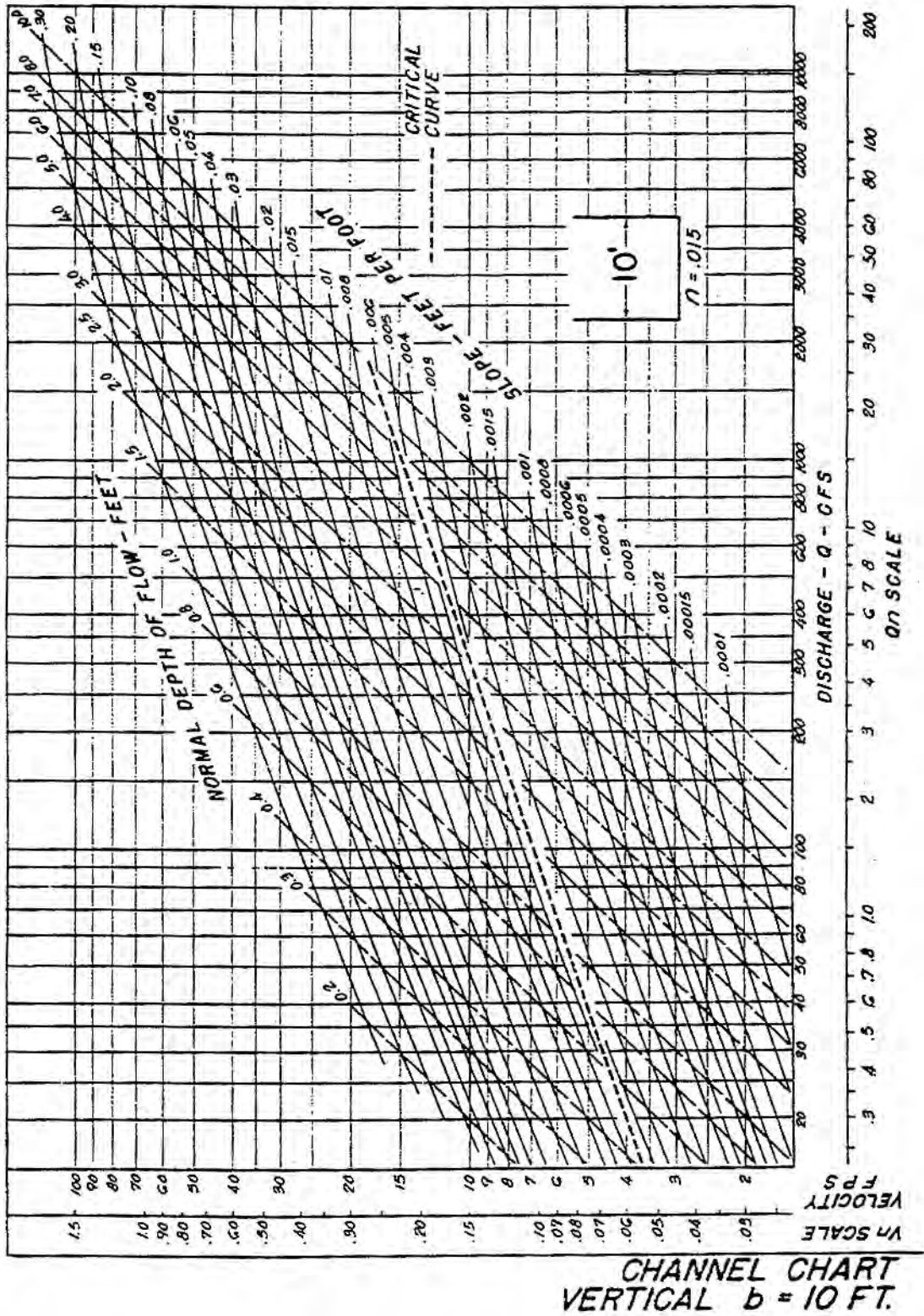
Source: HDS-3

Appendix 8C-85 Rectangular Channel Flow Chart (B=9')



Source: HDS-3

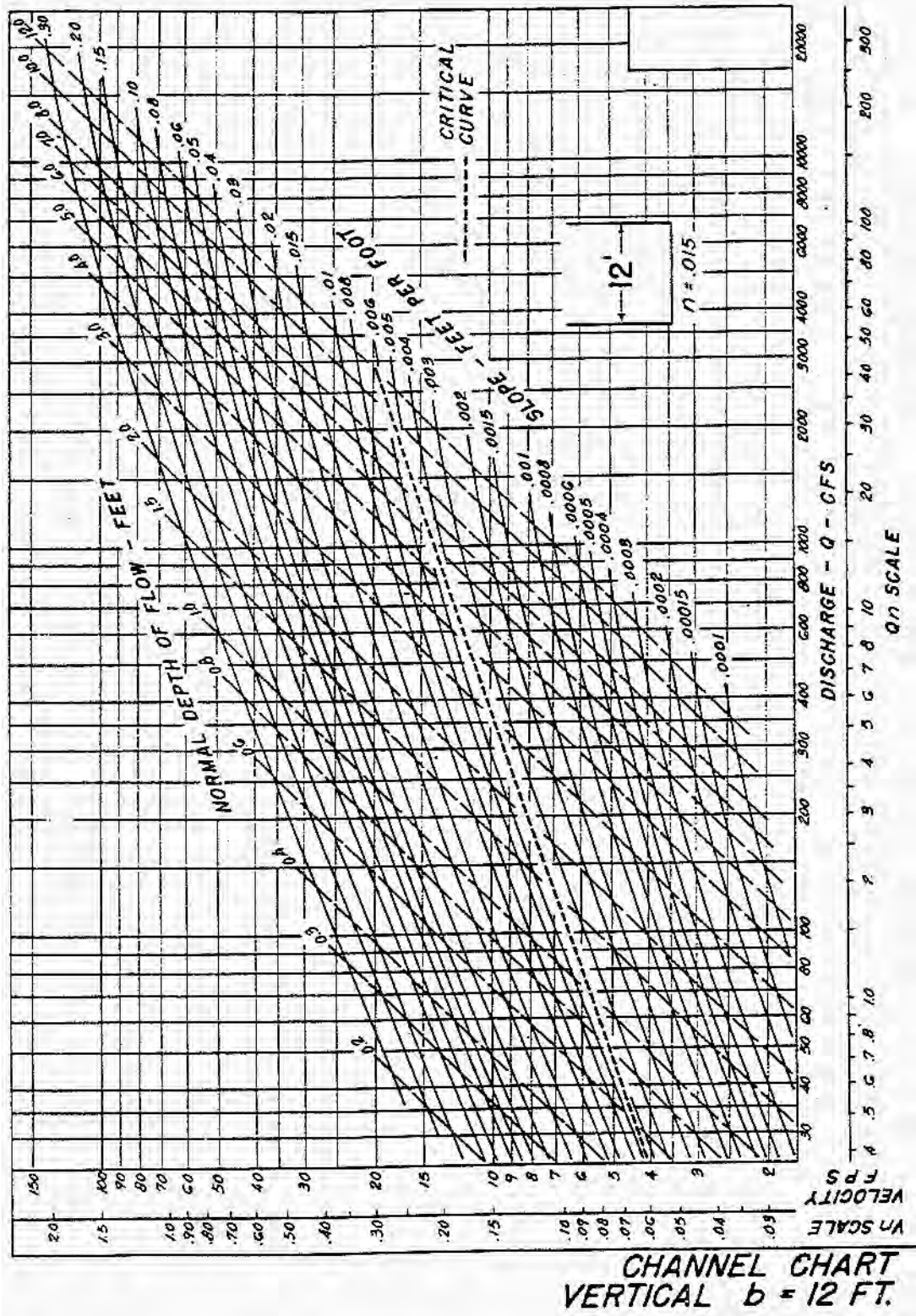
Appendix 8C-86 Rectangular Channel Flow Chart (B=10')



Source: HDS-3

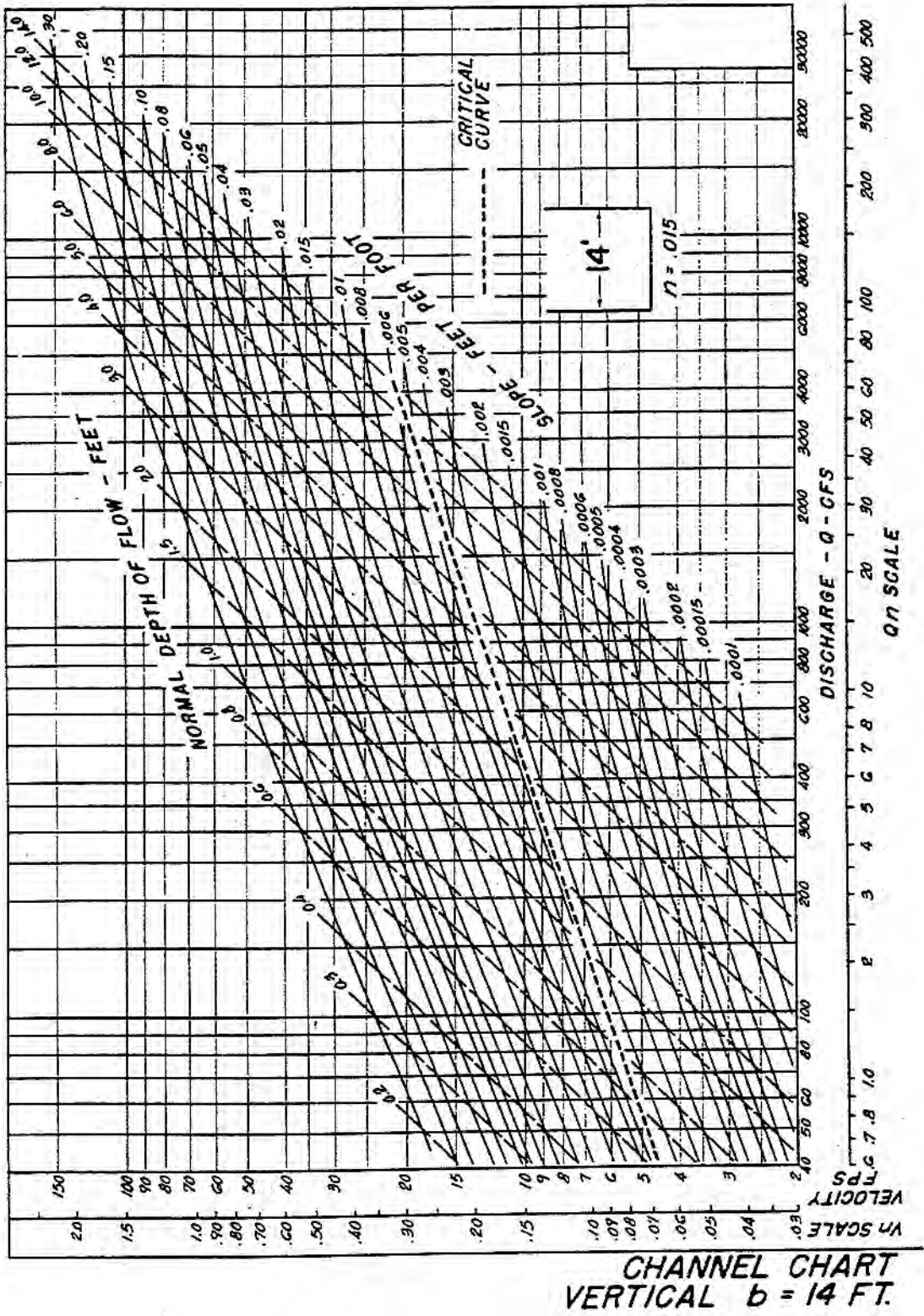


Appendix 8C-87 Rectangular Channel Flow Chart (B=12')



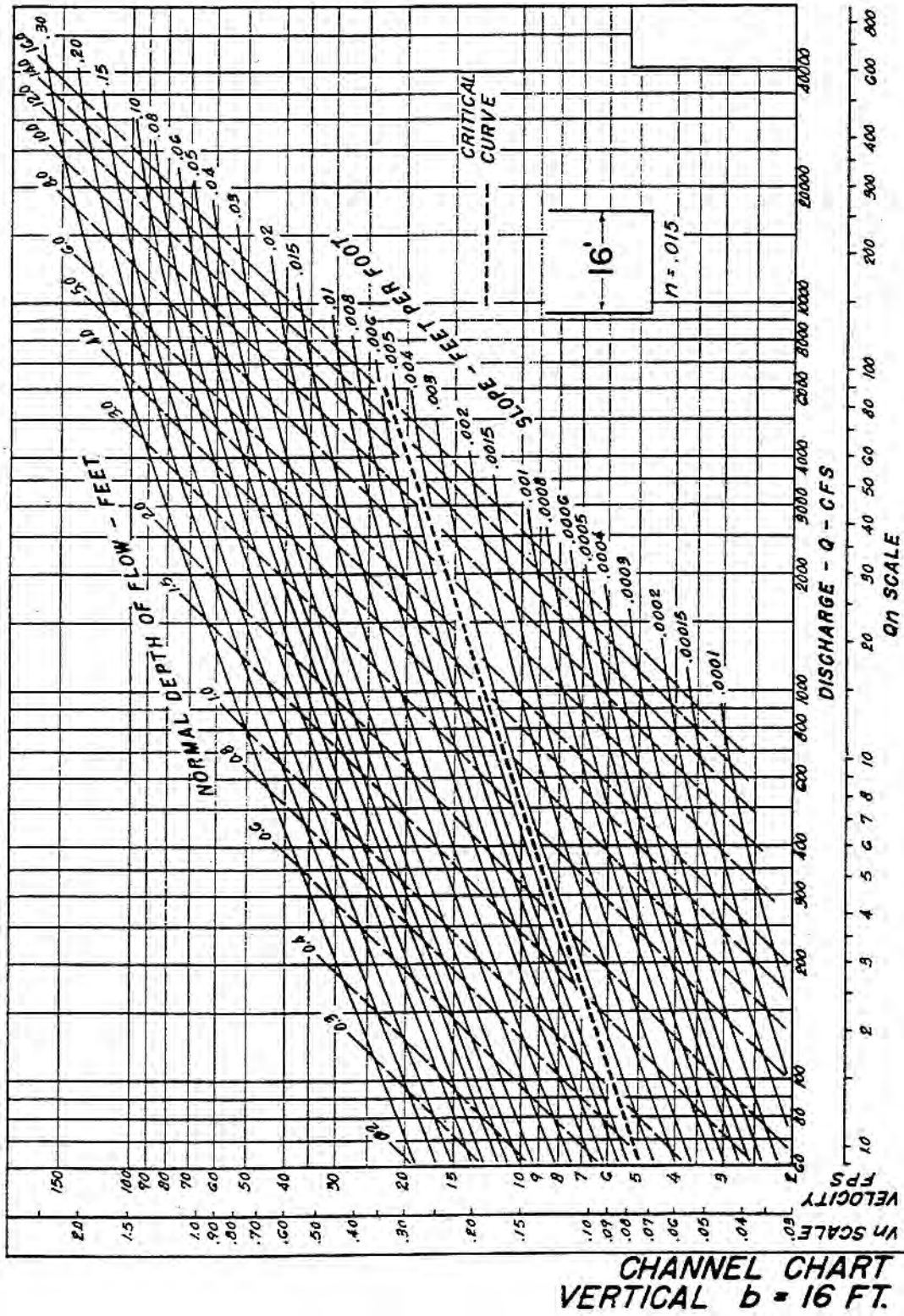
Source: HDS-3

Appendix 8C-88 Rectangular Channel Flow Chart (B=14')



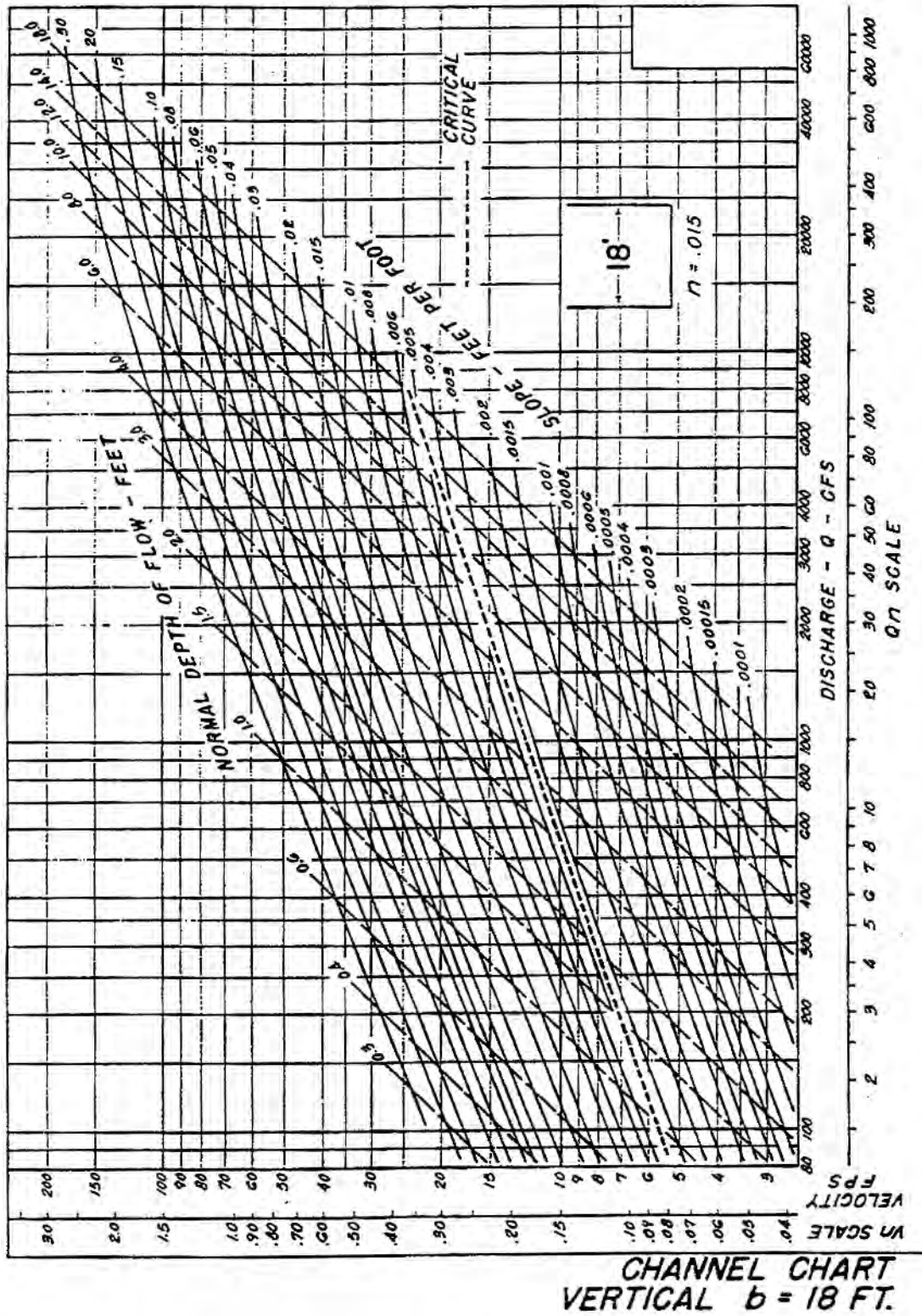
Source: HDS-3

Appendix 8C-89 Rectangular Channel Flow Chart (B=16')



Source: HDS-3

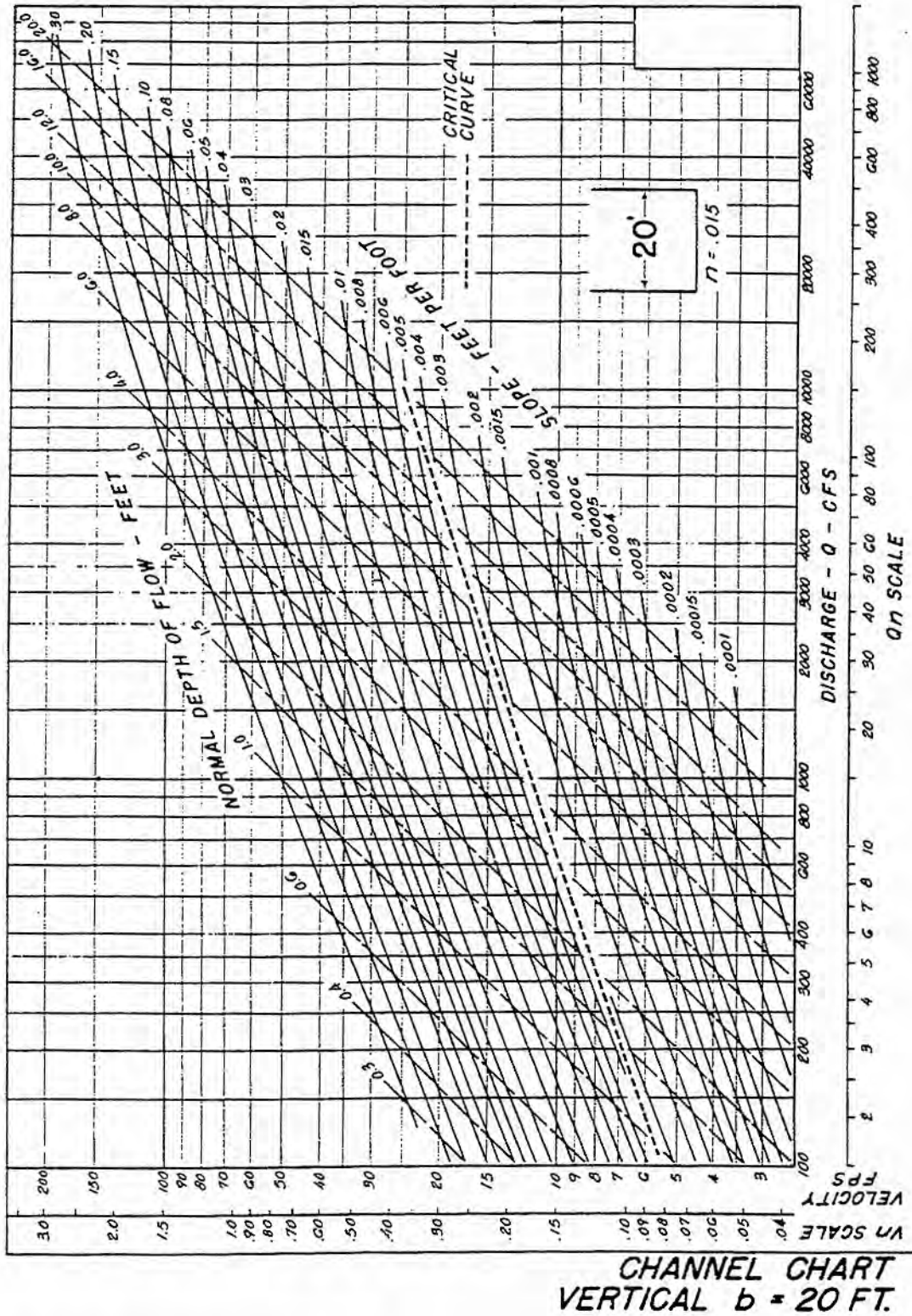
Appendix 8C-90 Rectangular Channel Flow Chart (B=18')



Source: HDS-3



Appendix 8C-91 Rectangular Channel Flow Chart (B=20')



Source: HDS-3

**Appendix 8D-1 Recommended Manning's n-Values**

Type of Conduit	Wall Description	Manning's n
Concrete Pipe	Smooth walls	0.010-0.013
Concrete Boxes	Smooth walls	0.012-0.015
Corrugated Metal	2 2/3 by 1/2 inch corrugations	0.022-0.027
Pipes and Boxes Annular or Helical Pipe (n varies Barrel size) See HDS5	6 by 1 inch corrugations	0.022-0.025
	5 by 1 inch corrugations	0.025-0.026
	3 by 1 inch corrugations	0.027-0.028
	6 by 2 inch structural plate	0.033-0.035
	9 by 2 1/2 inch structural plate	0.033-0.037
Corrugated Metal	2 2/3 by 1/2 inch corrugations	0.012-0.024
Pipes, Helical Corrugations, Full Circular Flow		
Spiral Rib Metal	Smooth walls	0.011-0.012

\*Note 1: The Values indicated in this table are recommended Manning's "n" design values. Actual Field values for older existing pipelines may vary depending on the effects of abrasion, corrosion, deflection and joint conditions. Concrete pipe with poor joints and deteriorated walls may have "n" values of 0.014 to 0.018. Corrugated metal pipe with joint and wall problems may also have higher "n" values, and in addition, may experience shape changes which could adversely effect the general hydraulic characteristics of the culvert.

Note 2: For further information concerning Manning n values for selected conduits consult Hydraulic Design of Highway Culverts, Federal Highway Administration, HDS No. 5, Table 4.

Source: HDS-5

**Chapter 8 - Culverts**

**Appendix 8D-2 Entrance Loss Coefficients ( $K_e$ ),  
Outlet Control, Full or Partly Full**

Type of Structure and Design of Entrance	Coefficient
<i>Pipe, Concrete</i>	
Mitered to conform to fill slope	0.7
*End-Section conforming to fill slope	0.5
Projecting from fill, sq. cut end	0.5
Headwall or headwall and wingwalls	
Square-edge	0.5
Rounded (radius = $D/12$ )	0.2
Socket end of pipe (groove-end)	0.2
Projecting from fill, socket end (groove-end)	0.2
Beveled edges, 33.7° or 45° bevels	0.2
Side-or slope-tapered inlet	0.2
<i>Pipe, or Pipe-Arch, Corrugated Metal</i>	
Projecting from fill (no headwall)	0.9
Mitered to conform to fill slope, paved or unpaved slope	0.7
Headwall or headwall and wingwalls square-edge	0.5
*End-Section conforming and to fill slope	0.5
Beveled edges, 33.7° or 45° bevels	0.2
Side-or slope-tapered inlet	0.2
<i>Box, Reinforced Concrete</i>	
Headwall parallel to embankment (no wingwalls)	
Square-edged on 3 edges	0.5
Rounded on 3 edges to radius of $D/12$ or $B/12$ or beveled edges on 3 sides	0.2
Wingwalls parallel (extension of sides)	
Square-edged at crown	0.7
Wingwalls at 10° to 25° to barrel	
Square-edged at crown	0.5
Wingwalls at 30° to 75° to barrel	
Crown edge rounded to radius of $D/12$ or beveled top edge	0.2
Square Edge at crown	0.4
Side-or slope-tapered inlet	0.2

\*Note : "End Sections conforming to fill slope," made of either metal or concrete, are the sections commonly available from manufacturers. From limited hydraulic tests they are equivalent in operation to a headwall in both inlet and outlet control. Some end sections, incorporating a closed taper in their design have a superior hydraulic performance. These latter sections can be designed using the information given for the beveled inlet.

Source HDS-5

---

**Appendix 8E-1 Energy Dissipation**

---

**8E.1 Riprap Basin**

Riprap basins are used for energy dissipation at the outlets of high velocity culverts.

Riprap basin design is based on laboratory data obtained from full-scale prototypical installations. The principal features of riprap basins are as follows:

1. Pre-shaping and lining with riprap of median size,  $d_{50}$ .
2. Constructing the floor at a depth of  $h_s$  below the invert, where  $h_s$  is the depth of scour that would occur in a pad of riprap of size  $d_{50}$ .
3. Sizing  $d_{50}$  so that  $2 < h_s/d_{50} < 4$ .
4. Sizing the length of the dissipating pool to be  $10(h_s)$  or  $3(W_o)$ , whichever is larger for a single barrel. The overall length of the basin is  $15(h_s)$  or  $4W_o$  whichever is larger.
5. Angular rock results are approximately the same as the results of rounded material.
6. Layout details and dimensions are shown on Figure 8E-1.

For high tailwater ( $\frac{TW}{d_o} > 0.75$ ), the following applies:

1. The high velocity core of water emerging from the culvert retains its jet-like character as it passes through the basin.
2. The scour hole is not as deep as with low tailwater and is generally longer.
3. Riprap may be required for the channel downstream of the rock-lined basin.

## 8E.2 Design Procedures and Sample Problems

The procedure shown below should be used to determine the dimension for a riprap basin energy dissipator for culvert and pipe installations with pipe velocities greater than or equal to 19 feet per second as classified in Section 8.3.2.6. Maximum Outlet Velocity within the Chapter 8 text.

*Step 1: Determine input flow parameters:  $D_e$  or  $d_E$ ,  $V_o$ ,  $F_r$  at the culvert outlet*

Where:

$$d_E = \text{Equivalent depth at the brink} = \sqrt{\frac{A}{2}}$$

Note:  $d_E = y_e$  in Figure 8E-2

*Step 2: Check TW*

$$\text{Determine if } \frac{TW}{d_o} \leq 0.75$$

Note:  $d_o = d_E$  in Figure 8E-2 for rectangular sections

*Step 3 Determine  $d_{50}$*

- Use Figure 8E-2.
- Select  $d_{50}/d_E$ . Satisfactory results will be obtained if  $0.25 < d_{50}/d_E < 0.45$ .
- Obtain  $h_s/d_E$  using Froude number ( $F_r$ ) and Figure 8E-2.
- Check if  $2 < h_s/d_{50} < 4$  and repeat until a  $d_{50}$  is found within the range.

*Step 4: Size basin*

- As shown in Figure 8E-1.
- Determine length of the dissipating pool,  $L_s = 10h_s$  or  $3W_o$  minimum.
- Determine length of basin,  $L_B = 15h_s$  or  $4W_o$  minimum.

Thickness of riprap: Approach =  $3d_{50}$  or  $1.5d_{\max}$   
 Remainder =  $2W_o$  or  $1.5d_{\max}$

---

**Appendix 8E-1 Energy Dissipation**


---

*Step 5: Determine exit velocity at brink ( $V_B$ )*

- a. Basin exit depth,  $d_B$  = critical depth at basin exit
- b. Basin exit velocity,  $V_B = \frac{Q}{W_B d_B}$
- c. Compare  $V_B$  with the average normal flow velocity in the natural channel ( $V_d$ )

*Step 6: High tailwater design*

- a. Design a basin for low tailwater conditions, Steps 1-5.
- b. Compute equivalent circular diameter ( $D_E$ ) for brink area from:

$$A = \frac{\pi D_E^2}{4} = d_o(W_o)$$

- c. Estimate centerline velocity at a series of downstream cross sections using Figure 8E-4.  
Size riprap using HEC -11 "Use of Riprap for Bank Protection."<sup>1</sup>

*Step 7: Design Filter*

The design filter is necessary unless the streambed material is sufficiently well graded. To design a filter for riprap, use the procedures in Section 4.4 of HEC-11.

Dissipator geometry can also be computed using the "Energy Dissipator" module that is available in the microcomputer program HY8, Culvert Analysis.

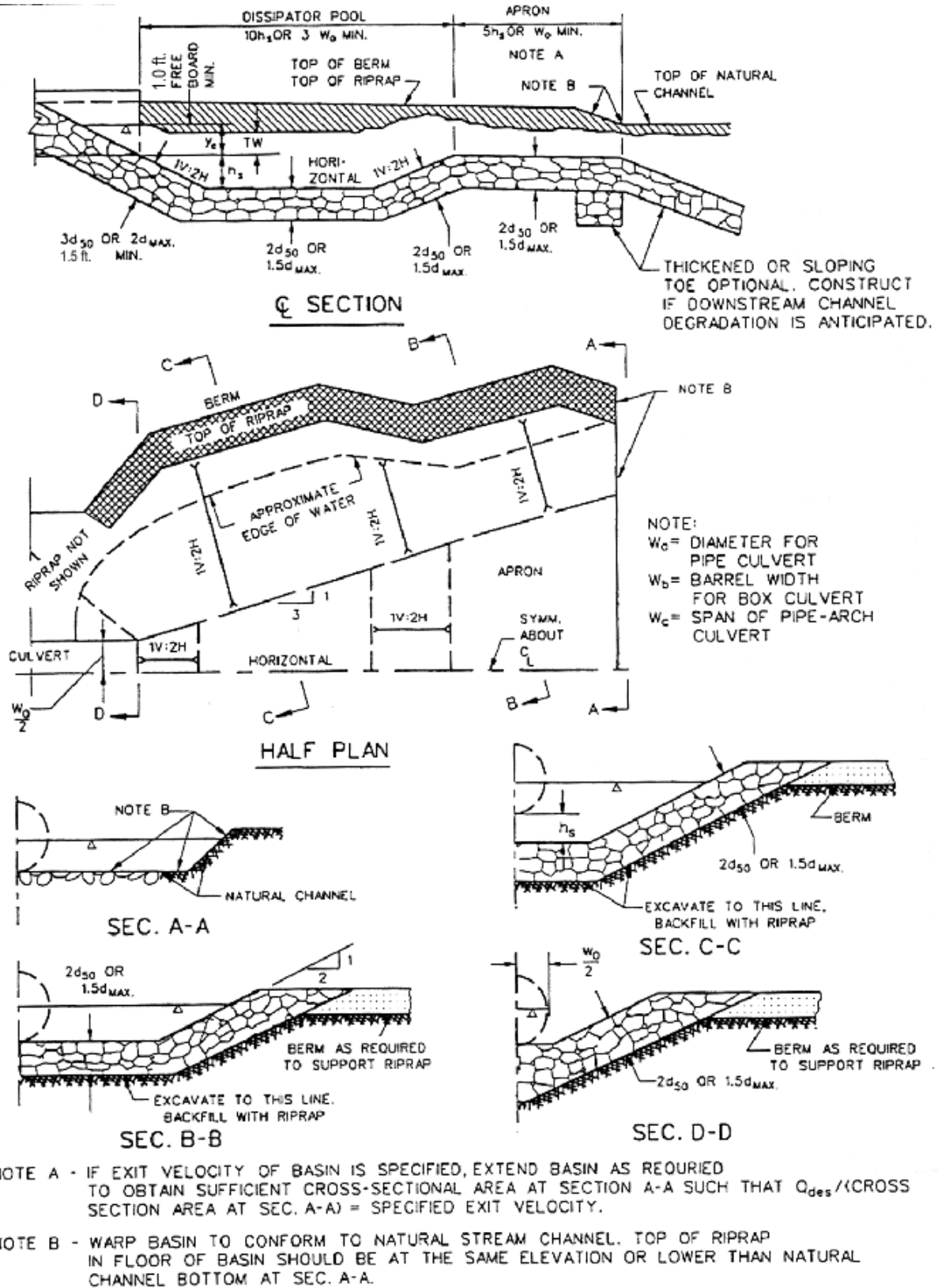


Figure 8E- 1. Details of Riprap Basin Energy Dissipator

Appendix 8E-1

Energy Dissipation

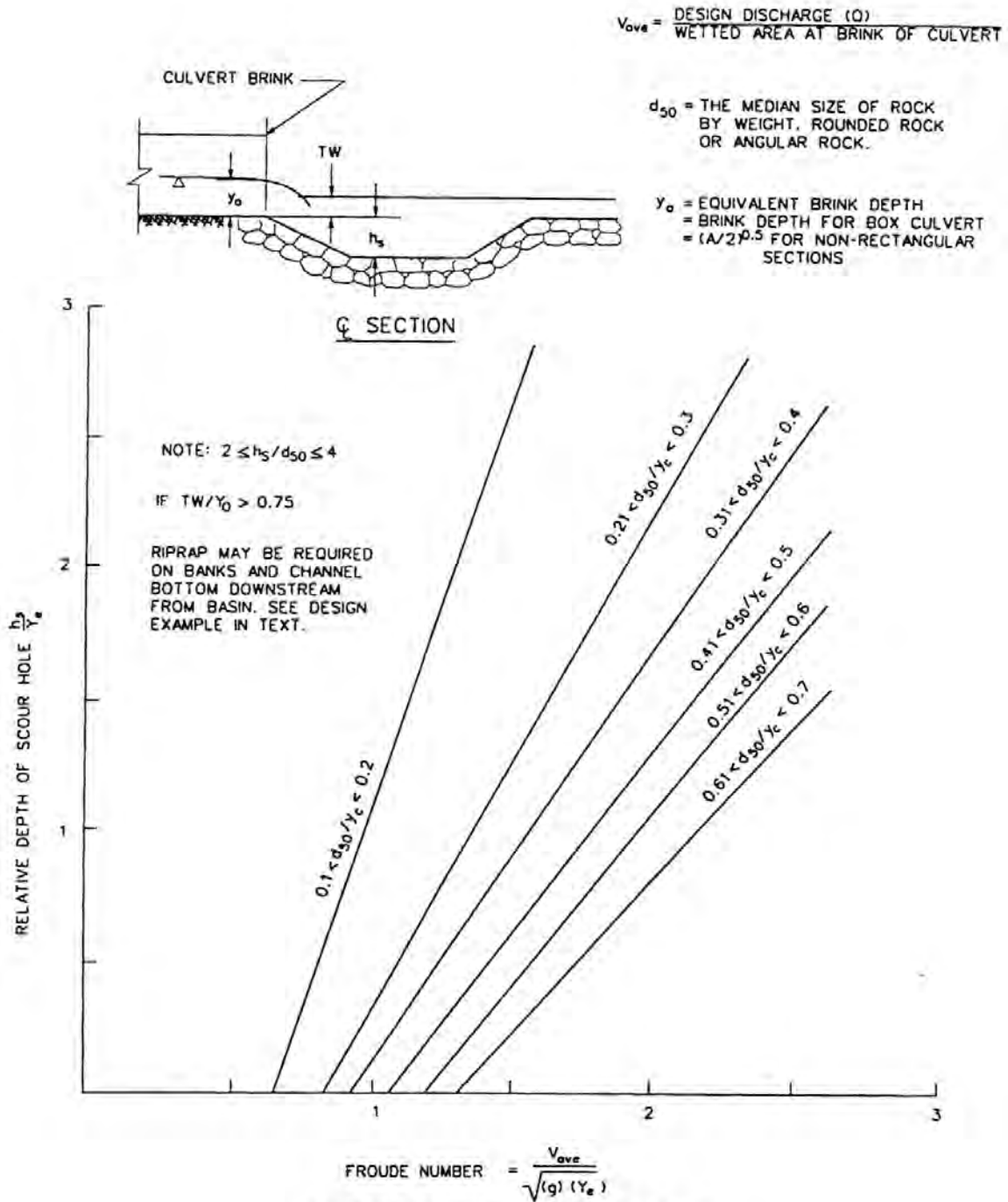


Figure 8E- 2. Riprap Basin Depth of Scour



RIPRAP BASIN													
Project No. _____ Designer _____ Date _____ Reviewer _____ Date _____													
DESIGN VALUES (Figure 8E-2)	TRIAL 1	FINAL TRIAL											
Equi. Depth, $d_E$			<table border="1" style="width: 100%; border-collapse: collapse;"> <thead> <tr> <th style="width: 50%;">BASIN DIMENSIONS</th> <th style="width: 50%;">FEET</th> </tr> </thead> <tbody> <tr> <td style="padding: 5px;">Pool length is the larger of:</td> <td style="padding: 5px;"><math>10h_s</math> <math>3W_o</math></td> </tr> <tr> <td style="padding: 5px;">Basin length is the larger of:</td> <td style="padding: 5px;"><math>15h_s</math> <math>4W_o</math></td> </tr> <tr> <td style="padding: 5px;">Approach Thickness</td> <td style="padding: 5px;"><math>3D_{50}</math></td> </tr> <tr> <td style="padding: 5px;">Basin Thickness</td> <td style="padding: 5px;"><math>2D_{50}</math></td> </tr> </tbody> </table>	BASIN DIMENSIONS	FEET	Pool length is the larger of:	$10h_s$ $3W_o$	Basin length is the larger of:	$15h_s$ $4W_o$	Approach Thickness	$3D_{50}$	Basin Thickness	$2D_{50}$
BASIN DIMENSIONS	FEET												
Pool length is the larger of:	$10h_s$ $3W_o$												
Basin length is the larger of:	$15h_s$ $4W_o$												
Approach Thickness	$3D_{50}$												
Basin Thickness	$2D_{50}$												
$D_{50}/d_E$													
$D_{50}$													
Froude No., $Fr$													
$h_s/d_E$													
$h_s$													
$h_s/D_{50}$													
$2 < h_s/D_{50} < 4$													

TAILWATER CHECK	
Tailwater, TW	
Equivalent depth, $d_E$	
$TW/d_E$	
IF $TW/d_E > 0.75$ , calculate riprap downstream using Figure 8E-4	
$D_E = (4A_c/\pi)^{0.5}$	

DOWNSTREAM RIPRAP (Figure 8E-4)				
L/ $D_E$	L	V <sub>L</sub> /V <sub>o</sub>	V <sub>L</sub>	D <sub>50</sub>
10				
15				
20				
21				

Figure 8E- 3. Riprap Basin Design Checklist

## Appendix 8E-1

## Energy Dissipation

## 8E.2.1 Riprap Design for Low Tailwater Condition-Sample Problem

Given: Box culvert: 8.0 ft by 6.0 ft.  
 Design discharge  $Q = 800$  cfs  
 Supercritical flow in culvert  
 Normal flow depth  $d_o =$  brink depth  $d_E = 4.0$  ft  
 Tailwater depth,  $TW = 2.8$  ft  
 Downstream channel velocity = 18 fps

Step 1: Determine input flow parameters:  $D_e$  or  $d_E$ ,  $V_o$ ,  $F_r$  at the culvert outlet

$d_o = d_E$  for rectangular section

$d_o = d_E = 4.0$  ft.

$$V_o = \frac{Q}{A} = \frac{800}{4.0(8.0)} = 25 \text{ fps}$$

$$F_r = \frac{V_o}{\sqrt{gd_E}} = \frac{25}{\sqrt{32.2(4.0)}} = 2.2 < 3.0$$

Step 2: Check  $TW$ :

Determine if  $\frac{TW}{d_E} < 0.75$

$$\frac{2.8}{4.0} = 0.70 < 0.75$$

Therefore,  $\frac{TW}{d_E} < 0.75$ , O.K.

Step 3: Determine  $d_{50}$ :

a. Use Figure 8E-2

b. Try  $d_{50}/d_E = 0.45$

$$d_{50} = \left( \frac{d_{50}}{d_E} \right) d_E = 0.45(4.0) = 1.8 \text{ ft.}$$

c. Obtain  $h_s/d_E$  using  $F_r = 2.2$  and line  $0.41 \leq d_{50}/d_E \leq 0.50$

$$h_s/d_E = 1.6$$

- d. Check if  $2 < h_s/d_{50} < 4$ :

$$h_s = \left( \frac{h_s}{d_E} \right) d_E = 1.6(4.0) = 6.4 \text{ ft.}$$

$$\frac{h_s}{d_{50}} = \frac{6.4}{1.8} = 3.55 \text{ ft.}$$

$$2 < 3.55 < 4, \text{ O.K.}$$

*Step 4: Size the basin:*

- a. As shown in Figure 8E-1
- b. Determine length of dissipating pool,  $L_S$ :  
 $L_S = 10h_s = 10(6.4) = 64 \text{ ft.}$   
 $L_S \text{ min.} = 3W_o = 3(8) = 24 \text{ ft}$   
 Therefore, use  $L_S = 64 \text{ ft}$
- c. Determine length of basin,  $L_B$ :  
 $L_B = 15h_s = 15(6.4) = 96 \text{ ft}$   
 $L_B \text{ min.} = 4W_o = 4(8) = 32 \text{ ft}$   
 Therefore, use  $L_B = 96 \text{ ft}$
- d. Thickness of riprap:  
 Approach =  $3d_{50} = 3(1.80) = 5.4 \text{ ft}$   
 Remainder =  $2d_{50} = 2(1.80) = 3.6 \text{ ft}$

*Step 5: Determine  $V_B$ :*

- a.  $d_B =$  Critical depth at basin exit = 3.30 ft. (assuming a rectangular cross section with width  $W_B = 24 \text{ ft.}$ )
- b.  $V_B = \frac{Q}{W_B d_B} = \frac{800}{24(3.3)} = 10 \text{ fps}$
- c.  $V_B = 10 \text{ fps} < V_d = 18 \text{ fps}$

## Appendix 8E-1

## Energy Dissipation

## 8E.2.2 Riprap Design for High Tailwater Condition-Sample Problem

Given: Data on the channel and the culvert are the same as Sample Problem 1, except that the new tailwater depth,

$$TW = 4.2 \text{ ft.}$$

$$\frac{TW}{d_o} = \frac{4.2}{4.0} = 1.05 > 0.75$$

Downstream channel can tolerate only 7.0 fps

Steps 1 through 5 are the same as Sample Problem 8E.2.1.

Step 6: High tailwater design:

- Design a basin for low tailwater conditions, Steps 1-5 as above:  
 $D_{50} = 1.8 \text{ ft}$ ,  $h_S = 6.4 \text{ ft}$   
 $L_S = 64 \text{ ft}$ ,  $L_B = 96 \text{ ft}$
- Compute equivalent circular diameter,  $D_E$ , for brink area from:  

$$A = \frac{\pi D_E^2}{4} = d_o(W_o) = 4.0(8.0) = 32 \text{ ft}^2$$

$$D_E = \sqrt{\frac{4A}{\pi}} = \sqrt{\frac{4(32)}{\pi}} = 6.4 \text{ ft.}$$
 $V_o = 25 \text{ fps}$  (Sample Problem 8E.2.1).
- Estimate centerline velocity at a series of downstream cross sections using Figure 8E-5.

$\frac{L^1}{D_E}$	L	$\frac{V_L}{V_o}$	$V_L$	$D_{50}^2$
10	64	0.59	14.7	1.4
15 <sup>3</sup>	96	0.36	9.0	0.6
20	128	0.30	7.5	0.4
21	135	0.28	7.0	0.4

<sup>1</sup> Use  $W_o = D_E$  in Figure 8E- 5.

<sup>2</sup> From Figure 8E- 6.

<sup>3</sup> Is on a logarithmic scale so interpolations must be performed logarithmically.

- Size riprap using HEC 11. The channel can be lined with the same size rock used for the basin. Protection should extend at least 135 ft downstream.

This information is summarized in the worksheet for riprap basin design, Figure 8E- 4.

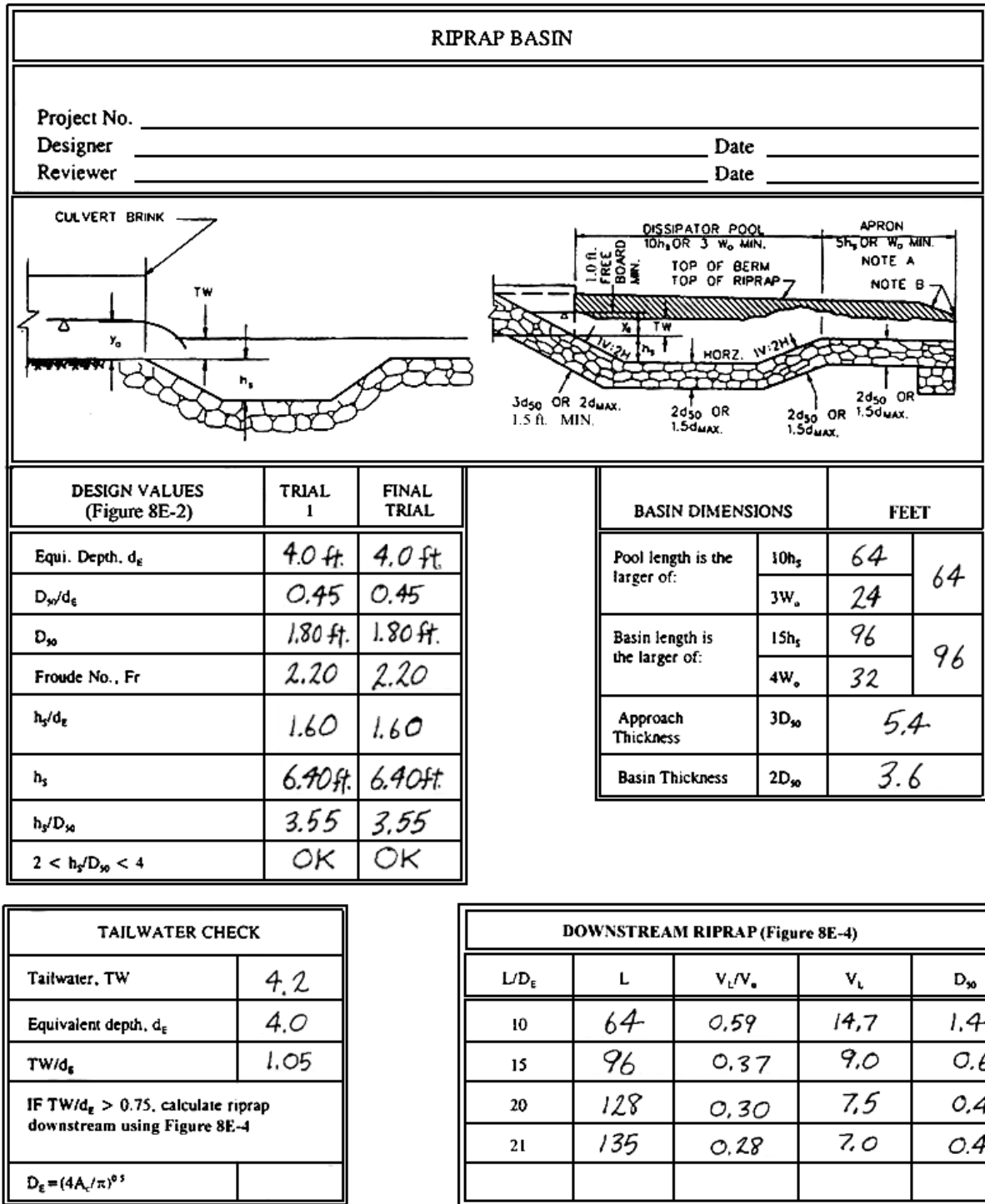


Figure 8E- 4. Riprap Basin Design Worksheet, Sample Problem

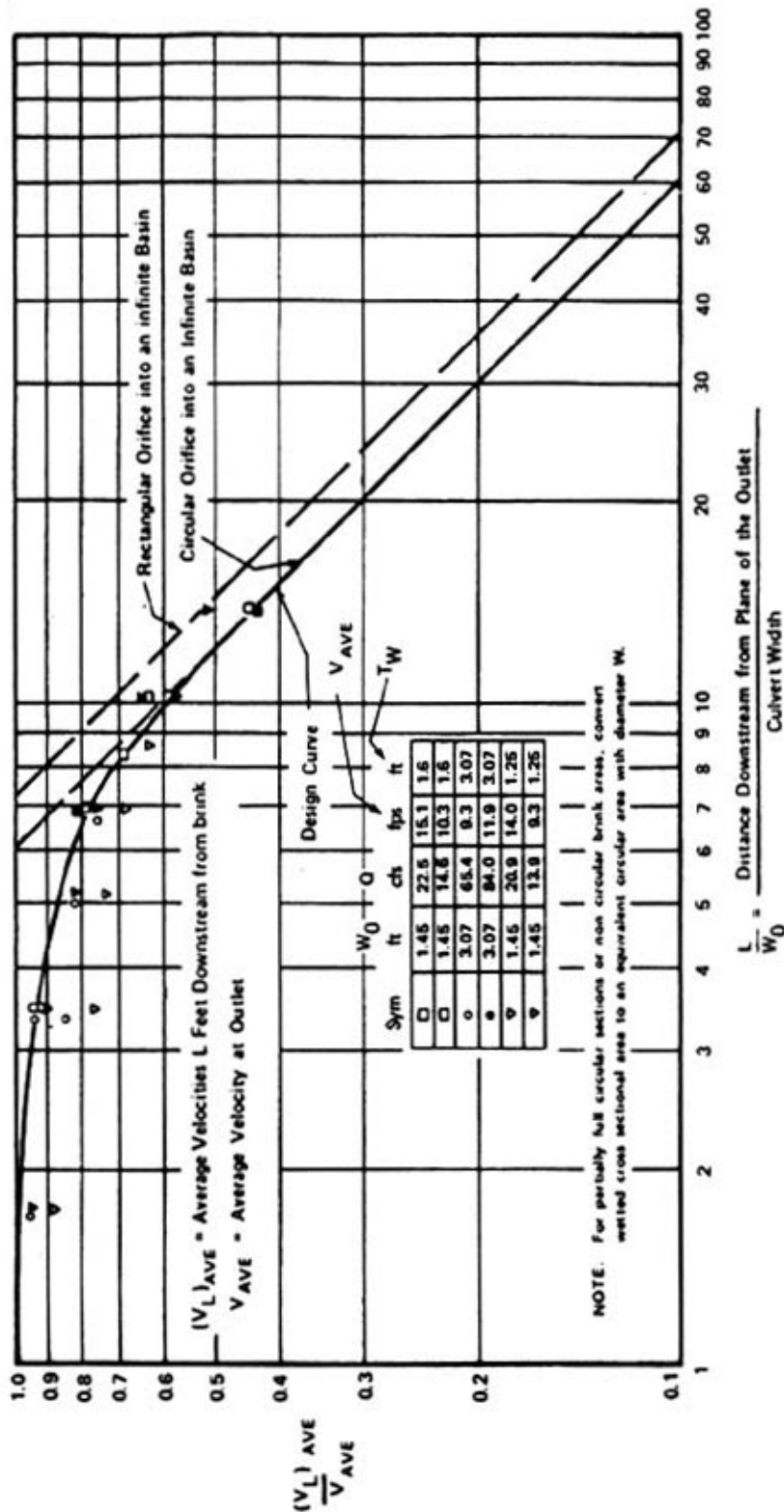


Figure XI - 3 Distribution of Centerline Velocity for Flow from Submerged Outlets from Reference XI - 2. to be used for Predicting Channel Velocities Downstream from Culvert Outlet where High Tailwater prevails. Velocities obtained from the use of this Chart can be used with Figure 2 of HEC No. 11 for sizing riprap (DO not use Figure 1 HEC No. 11, use Mean Velocity Values)

Figure 8E- 5. Distribution of Centerline Velocity for Flow from Submerged Outlets

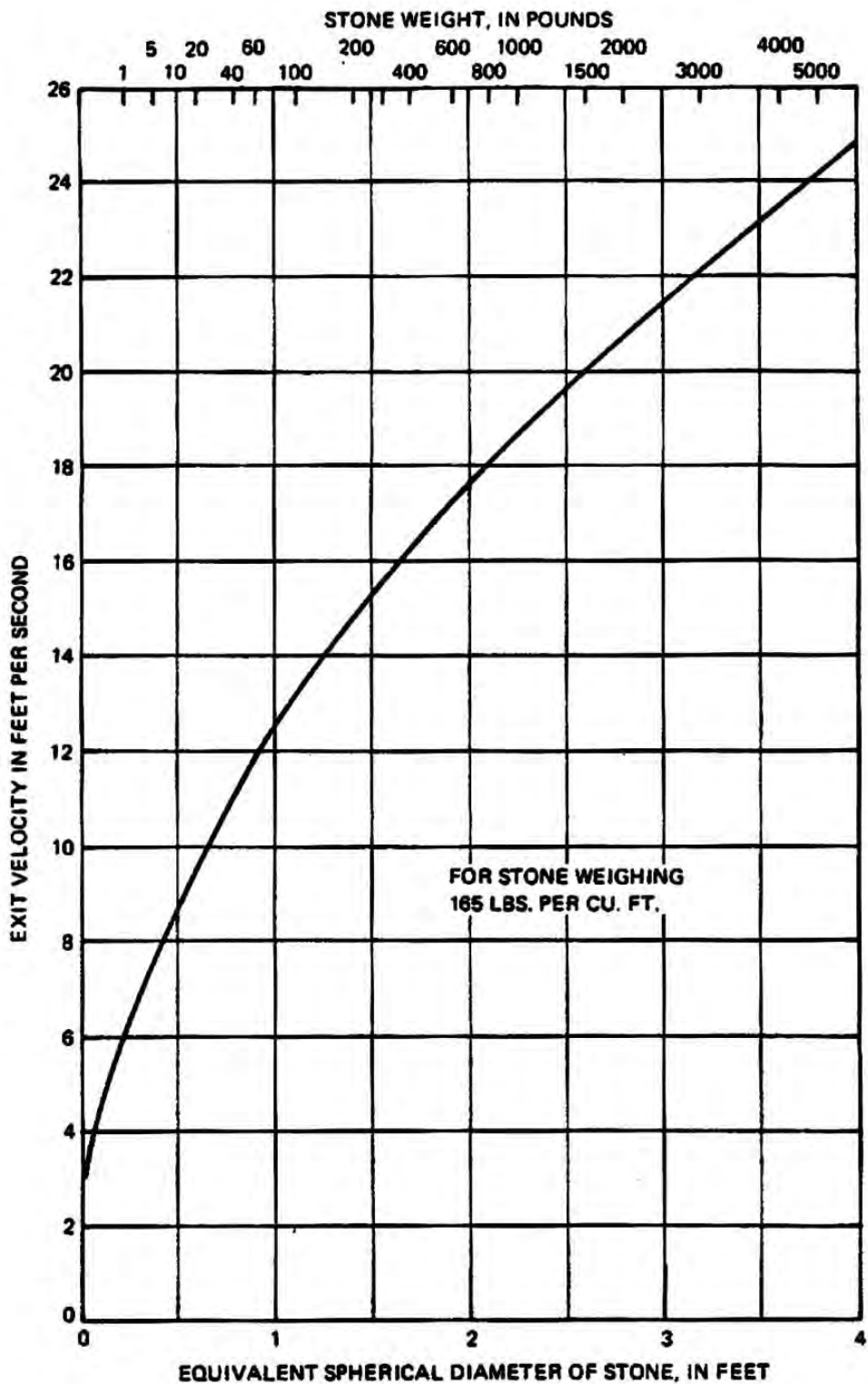


Figure 8E- 6. Riprap Size Versus Exit Velocity



## Appendix 8E-1

## Energy Dissipation

## 8E.2.3 Computer Output

The dissipator geometry can be computed using the “Energy Dissipator” module, which is available in FHWA’s HY8, Culvert Analysis microcomputer program. The output of the culvert data, channel input data, and computed geometry using this module are shown below.

## FHWA CULVERT ANALYSIS, HY-8, VERSION 6.0

CURRENT DATE	CURRENT TIME	FILE NAME	FILE DATE
06-02-1997	15:23:59	ENERGY3	06-02-1997

## CULVERT AND CHANNEL DATA

CULVERT NO. 1	DOWNSTREAM CHANNEL
CULVERT TYPE: 8.0 ft X 6.0 ft, BOX	CHANNEL TYPE: IRREGULAR
CULVERT LENGTH = 300 ft	BOTTOM WIDTH = 8.0 ft
NO. OF BARRELS = 1.0	TAILWATER DEPTH = 2.8 ft
FLOW PER BARREL = 400 cfs	TOTAL DESIGN FLOW = 400 cfs
INVERT ELEVATION = 172.5 ft	BOTTOM ELEVATION = 172.5 ft
OUTLET VELOCITY = 25 fps	NORMAL VELOCITY = 32 fps
OUTLET DEPTH = 4.0 ft	

## RIPRAP STILLING BASIN – FINAL DESIGN

THE LENGTH OF THE BASIN	= 96.3 ft
THE LENGTH OF THE POOL	= 64.2 ft
THE LENGTH OF THE APRON	= 32 ft
THE WIDTH OF THE BASIN AT THE OUTLET	= 8.0 ft
THE DEPTH OF POOL BELOW CULVERT INVERT	= 6.4 ft
THE THICKNESS OF THE RIPRAP ON THE APRON	= 6.6 ft
THE THICKNESS OF THE RIPRAP ON THE REST OF THE BASIN	= 5.0 ft
THE BASIN OUTLET VELOCITY	= 17 fps
THE DEPTH OF FLOW AT BASIN OUTLET	= 6.0 ft

**Appendix 8F-1 Handling Weight for Corrugated Steel Pipe  
(2<sup>2</sup>/<sub>3</sub>"x1<sup>1</sup>/<sub>2</sub>" Corrugations)**

**Table 1-3 Handling Weight of Corrugated Steel Pipe (2<sup>2</sup>/<sub>3</sub> x 1<sup>1</sup>/<sub>2</sub> in)  
Estimated Average Weights – Not for Specification Use\***

Inside Diameter In Inches	Specified Thickness In Inches	Approximate Pounds per Lineal Foot **			
		Galvanized	Full-Coated	Full-Coated and Invert Paved	Full-Coated and Full Paved
12	.052	8	10	13	
	.064	10	12	15	
	.079	12	14	17	
15	.052	10	12	15	
	.064	12	15	18	
	.079	15	18	21	
18	.052	12	14	17	
	.064	15	19	22	
	.079	18	22	25	
21	.052	14	16	19	
	.064	17	21	26	
	.079	21	25	30	
24	.052	15	17	20	
	.064	19	24	30	45
	.079	24	29	35	60
30	.052	20	22	25	
	.064	24	30	36	55
	.079	30	36	42	60
36	.052	24	26	29	
	.064	29	36	44	65
	.079	36	43	51	75
42	.052	28	30	33	
	.064	34	42	51	
	.079	42	50	59	85
48	.052	31	33	36	
	.064	38	48	57	
	.079	48	58	67	95
54	.064	44	55	66	95
	.079	54	65	76	105
	.079	60	71	85	
60	.109	81	92	106	140
	.109	89	101	117	160
	.138	113	125	141	180
72	.109	98	112	129	170
	.138	123	137	154	210
	.109	105	121	138	200
78	.138	133	149	166	230
	.109	113	133	155	225
	.138	144	161	179	240
90	.109	121	145	167	
	.138	154	172	192	
	.168	186	204	224	
96	.138	164	191	217	
	.168	198	217	239	

\* Lock seam construction only; weights will vary with other fabrication practices.

\*\* For other coatings or linings the weights may be interpolated.

Note: Pipe arch weights will be the same as the equivalent round pipe.

For example; for 42 x 29, 2<sup>2</sup>/<sub>3</sub> x 1<sup>1</sup>/<sub>2</sub> in Pipe Arch, refer to 36 in diameter pipe weight.

Smooth steel lined CSP weights approximately 5% more than single wall galvanized.

Source:

Appendix 8F-2 Handling Weight for Corrugated Steel Pipe  
(3"x1" or 125 mm x 25 mm Corrugations)

Table 1-4 Handling Weight of Corrugated Steel Pipe (3 x 1 In or 125 x 25 mm)<sup>\*\*\*</sup>  
Estimated Average Weights—Not for Specification Use\*

Inside Diameter In Inches	Specified Thickness In Inches	Approximate Pounds per Lineal Foot **			
		Galvanized	Full-Coated	Full-Coated and Invert Paved	Full-Coated and Full Paved
54	.064	50	66	84	138
	.079	61	77	95	149
60	.064	55	73	93	153
	.079	67	86	105	165
66	.064	60	80	102	168
	.079	74	94	116	181
72	.064	66	88	111	183
	.079	81	102	126	197
78	.064	71	95	121	198
	.079	87	111	137	214
84	.064	77	102	130	213
	.079	94	119	147	230
90	.064	82	109	140	228
	.079	100	127	158	246
96	.064	87	116	149	242
	.079	107	136	169	262
102	.064	93	124	158	258
	.079	114	145	179	279
108	.064	98	131	166	273
	.079	120	153	188	295
114	.064	104	139	176	289
	.079	127	162	199	312
120	.064	109	146	183	296
	.079	134	171	210	329
	.109	183	220	259	378
126	.079	141	179	220	346
	.109	195	233	274	400
132	.079	148	188	231	363
	.109	204	244	287	419
138	.079	154	196	241	379
	.109	213	255	300	438
144	.109	223	267	314	458
	.138	282	326	373	517

\* Lock seam construction only; weights will vary with other fabrication practices.

\*\* For other coatings or linings the weights may be interpolated.

\*\*\* 125 x 25mm may be referred to as 5 x 1 in. and weighs approximately 12% less than 3 x 1 in.

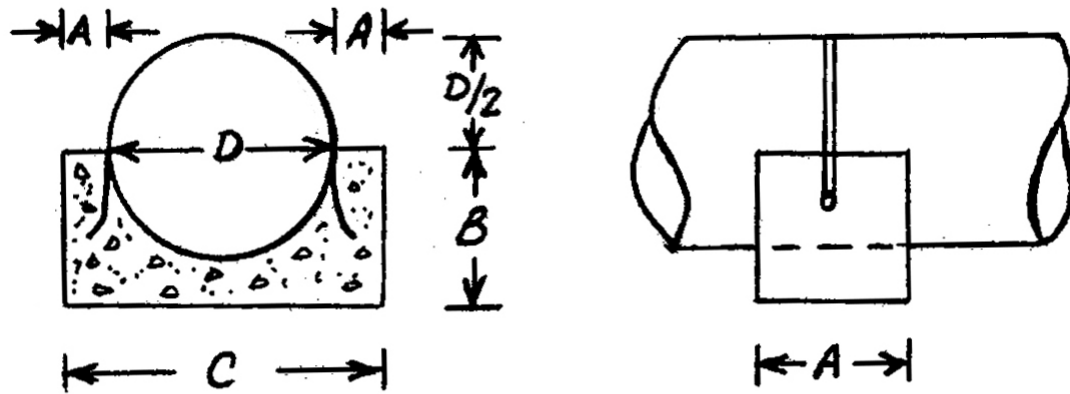
Note: Pipe arch weights will be the same as the equivalent round pipe.  
For example; for 42 x 29, 2 3/4 x 1/2 in Pipe Arch, refer to 36 in. diameter pipe weight.  
Smooth steel lined CSP weighs approximately 5% more than single wall galvanized.

Source:

Appendix 8F-3

Dimension and Weight  
of Minimum Size Counterweight

DIMENSIONS AND WEIGHT OF MINIMUM SIZE COUNTERWEIGHT



- A = 6"
- B =  $D / 2 + 12$ "
- C =  $D + 12$ "
- D = PIPE DIAMETER

\* WEIGHT OF CONCRETE @ 150 LBS. PER CU. FT.

Pipe Diameter (inches)	Dimensions (inches)			Concrete	
	A	B	C	Volume (cu. ft.)	Weight* (lbs.)
D					
12	6	18	24	1.30	195
15	6	19.5	27	1.52	228
18	6	21	30	1.75	263
24	6	24	36	2.22	333
30	6	27	42	2.71	407
36	6	30	48	3.23	485
42	6	33	54	3.78	567
48	6	36	60	4.36	654
54	6	39	66	4.96	744
60	6	42	72	5.59	839
66	6	45	78	6.25	938
72	6	48	84	6.93	1040

Source:

**Appendix 8F-4 Diameter Dimensions and  $D^{2.5}$  Values for Structural Plate Corrugated Circular Pipe (9" x 2 1/2" Aluminum Corrugations)**

Diameter (feet)		$D^{2.5}$	Plates per Ring
Nominal	Actual		
6.5	6.42	104.4	2
7.0	6.93	126.4	2
7.5	7.44	151.0	3
8.0	7.96	178.8	3
8.5	8.46	208.2	3
9.0	8.97	241.0	3
9.5	9.48	276.7	3
10.0	9.99	315.4	3
10.5	10.50	357.2	3
11.0	11.01	402.2	4
11.5	11.52	450.4	4
12.0	12.04	503.0	4
12.5	12.54	556.9	4
13.0	13.05	615.2	4
13.5	13.57	678.3	4
14.0	14.08	743.9	4
14.5	14.59	813.1	5
15.0	15.10	886.0	5

Source:

**Appendix 8F-4 Diameter Dimensions and  $D^{2.5}$  Values for Structural Plate Corrugated Circular Pipe (9" x 2 1/2" Aluminum Corrugations)**

Diameter (feet)		$D^{2.5}$	Plates per Ring
Nominal	Actual		
6.5	6.42	104.4	2
7.0	6.93	126.4	2
7.5	7.44	151.0	3
8.0	7.96	178.8	3
8.5	8.46	208.2	3
9.0	8.97	241.0	3
9.5	9.48	276.7	3
10.0	9.99	315.4	3
10.5	10.50	357.2	3
11.0	11.01	402.2	4
11.5	11.52	450.4	4
12.0	12.04	503.0	4
12.5	12.54	556.9	4
13.0	13.05	615.2	4
13.5	13.57	678.3	4
14.0	14.08	743.9	4
14.5	14.59	813.1	5
15.0	15.10	886.0	5

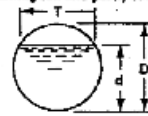
Source:

Appendix 8F-5

Geometric Properties and Critical Flow Factors for Circular Conduits Flowing Full and Partly Full

Table 4. - Geometric properties and critical flow factors for circular conduits flowing full and partly full

$d$  = Depth of flow  
 $d_c$  = Critical depth  
 $\bar{d}$  = Mean depth  
 $D$  = Diameter of pipe  
 $A$  = Area of flow  
 $R$  = Hydraulic radius  
 $T$  = Top width of flow  
 $Q_c$  = Discharge at a critical flow condition  
 $H_c$  = Specific head at critical flow  
 $H_p = d_c + (v^2)/(2gD)$  (invariant with  $\alpha$ )  
 $V_c$  = Critical velocity  
 $\alpha$  = Kinetic energy correction factor  
 $g$  = Acceleration due to gravity = 32.16 ft./sec.<sup>2</sup>



$d/D$ or $d_c/D$	A D <sup>2</sup>	R D	T D	$d_c/D$	$Q_c$ D <sup>3/2</sup>			$\alpha^2$ 2gD	$H_c$ D
					$\alpha=1.00$	$\alpha=1.04$	$\alpha=1.12$		
1.00	0.7854	0.2500	—	—	—	—	—	—	
0.95	.7841	.2666	0.1900	—	—	—	—	—	
.96	.7817	.2725	.2000	—	—	—	—	—	
.97	.7785	.2787	.2112	2.2817	5.6695	6.5400	6.3921	1.1410	
.98	.7747	.2852	.2239	1.5773	5.1785	6.0585	5.9381	1.0683	
.95	.7707	.2855	.4379	1.2681	5.8119	5.6991	5.4917	.8840	
.94	.7662	.2825	.4750	1.2131	5.2182	5.4111	5.2142	.8063	
.93	.7612	.2921	.5103	1.4017	5.3927	5.1183	4.9822	.7459	
.92	.7560	.2944	.5426	1.3933	5.0602	4.9620	4.7814	.6965	
.91	.7509	.2953	.5729	1.3110	4.8724	4.7170	4.5040	.6565	
.90	.7445	.2980	.6000	1.2408	4.7033	4.4920	4.3442	.6205	
.89	.7384	.2995	.6238	1.1799	4.5486	4.4503	4.2980	.5899	
.88	.7320	.3007	.6439	1.1283	4.4087	4.2292	4.1620	.5633	
.87	.7254	.3016	.6609	1.0785	4.2722	4.1893	4.0369	.5393	
.86	.7186	.3022	.6749	1.0304	4.1466	4.0661	3.9182	.5177	
.85	.7115	.3023	.7142	0.9962	4.0276	3.9495	3.8057	.4982	
.84	.7043	.3020	.7322	.9606	3.9144	3.8386	3.6988	.4802	
.83	.6969	.3011	.7513	.9276	3.8062	3.7323	3.5965	.4637	
.82	.6893	.3003	.7664	.8971	3.7021	3.6302	3.4982	.4484	
.81	.6815	.3003	.7846	.8686	3.6020	3.5321	3.4036	.4343	
.80	.6736	.3002	.8008	.8420	3.5061	3.4370	3.3120	.4209	
.79	.6655	.3039	.8146	.8170	3.4111	3.3445	3.2232	.4084	
.78	.6573	.3036	.8285	.7934	3.3200	3.2555	3.1371	.3966	
.77	.6488	.3031	.8417	.7709	3.2314	3.1687	3.0534	.3855	
.76	.6405	.3024	.8547	.7498	3.1450	3.0839	2.9717	.3749	
.75	.6319	.3017	.8660	.7297	3.0626	3.0012	2.8920	.3648	
.74	.6231	.3008	.8773	.7102	2.9773	2.9208	2.8142	.3552	
.73	.6143	.3008	.8879	.6919	2.8977	2.8414	2.7381	.3459	
.72	.6054	.2987	.8980	.6742	2.8188	2.7641	2.6635	.3371	
.71	.5964	.2975	.9075	.6572	2.7416	2.6884	2.5906	.3285	
.70	.5872	.2962	.9155	.6417	2.6654	2.6138	2.5188	.3204	
.69	.5780	.2948	.9250	.6269	2.5912	2.5409	2.4485	.3125	
.68	.5687	.2933	.9330	.6095	2.5182	2.4693	2.3795	.3048	
.67	.5594	.2917	.9404	.5949	2.4466	2.3990	2.3117	.2974	
.66	.5499	.2900	.9474	.5801	2.3760	2.3299	2.2451	.2902	
.65	.5404	.2882	.9539	.5645	2.3068	2.2620	2.1797	.2833	
.64	.5308	.2862	.9600	.5499	2.2386	2.1961	2.1153	.2765	
.63	.5212	.2842	.9656	.5358	2.1717	2.1325	2.0521	.2699	
.62	.5115	.2821	.9708	.5219	2.1069	2.0669	1.9898	.2635	
.61	.5018	.2799	.9755	.5114	2.0410	2.0014	1.9286	.2572	
.60	.4920	.2776	.9798	.5021	1.9773	1.9369	1.8684	.2511	
.59	.4822	.2753	.9837	.4902	1.9147	1.8715	1.8072	.2451	
.58	.4724	.2728	.9871	.4786	1.8531	1.8171	1.7510	.2393	
.57	.4625	.2703	.9902	.4671	1.7924	1.7576	1.6937	.2335	
.56	.4526	.2676	.9928	.4559	1.7328	1.6999	1.6373	.2279	
.55	.4425	.2649	.9950	.4448	1.6741	1.6416	1.5819	.2221	
.54	.4327	.2621	.9968	.4331	1.6156	1.5852	1.5275	.2170	
.53	.4227	.2592	.9981	.4215	1.5584	1.5293	1.4739	.2117	
.52	.4127	.2562	.9992	.4100	1.5014	1.4749	1.4212	.2065	
.51	.4027	.2531	.9998	.4028	1.4454	1.4213	1.3696	.2014	
.50	.3927	.2500	1.0000	.3927	1.3906	1.3685	1.3187	.1964	
.49	.3827	.2468	.9998	.3828	1.3367	1.3166	1.2687	.1914	
.48	.3727	.2435	.9992	.3730	1.2838	1.2657	1.2197	.1865	
.47	.3627	.2401	.9982	.3634	1.2319	1.2159	1.1717	.1817	
.46	.3527	.2366	.9968	.3538	1.1800	1.1669	1.1244	.1770	
.45	.3428	.2331	.9950	.3445	1.1410	1.1188	1.0781	.1722	
.44	.3328	.2295	.9928	.3352	1.0929	1.0717	1.0327	.1677	
.43	.3229	.2258	.9902	.3261	1.0459	1.0254	0.9883	.1631	
.42	.3130	.2220	.9871	.3171	0.9997	0.9803	.9446	.1586	
.41	.3032	.2182	.9837	.3082	.9546	.9361	.9020	.1541	
.40	.2934	.2143	.9799	.2994	.9104	.8927	.8602	.1497	
.39	.2836	.2102	.9755	.2907	.8672	.8504	.8194	.1454	
.38	.2739	.2062	.9708	.2821	.8249	.8089	.7795	.1410	
.37	.2642	.2020	.9656	.2736	.7836	.7684	.7404	.1368	
.36	.2546	.1978	.9600	.2652	.7433	.7289	.7024	.1325	
.35	.2450	.1935	.9539	.2568	.7040	.6903	.6632	.1284	
.34	.2355	.1891	.9474	.2486	.6657	.6523	.6250	.1242	
.33	.2260	.1847	.9404	.2405	.6284	.6162	.5898	.1202	
.32	.2165	.1802	.9330	.2323	.5921	.5806	.5545	.1161	
.31	.2070	.1756	.9250	.2242	.5569	.5461	.5202	.1121	
.30	.1982	.1709	.9165	.2163	.5226	.5125	.4878	.1081	
.29	.1890	.1662	.9075	.2083	.4893	.4798	.4563	.1042	
.28	.1800	.1614	.8980	.2004	.4571	.4482	.4251	.1003	
.27	.1711	.1566	.8879	.1927	.4259	.4175	.3944	.0963	
.26	.1623	.1516	.8773	.1850	.3957	.3880	.3739	.0924	
.25	.1535	.1466	.8660	.1773	.3667	.3596	.3465	.0887	
.24	.1449	.1416	.8542	.1696	.3386	.3320	.3199	.0849	
.23	.1365	.1364	.8417	.1622	.3116	.3054	.2944	.0810	
.22	.1281	.1312	.8285	.1546	.2857	.2802	.2700	.0773	
.21	.1199	.1259	.8145	.1472	.2609	.2568	.2465	.0736	
0.20	0.1118	0.1206	0.8000	0.1397	0.2371	0.2335	0.2240	0.0699	
.19	.1039	.1152	.7845	.1324	.2144	.2102	.2020	.0662	
.18	.0961	.1097	.7684	.1251	.1928	.1891	.1822	.0626	
.17	.0885	.1042	.7513	.1178	.1724	.1691	.1629	.0590	
.16	.0811	.0986	.7332	.1106	.1530	.1500	.1446	.0553	
.15	.0739	.0929	.7142	.1035	.1347	.1321	.1272	.0516	
.14	.0668	.0871	.6940	.0963	.1176	.1153	.1111	.0482	
.13	.0600	.0813	.6726	.0892	.1016	.0995	.0960	.0446	
.12	.0534	.0755	.6499	.8222	.0868	.0850	.0819	.0411	
.11	.0470	.0695	.6258	.0751	.0731	.0717	.0691	.0375	

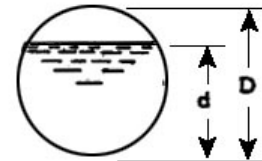
Source:



**Appendix 8F-6 Velocity Head and Resistance Computations Factors for Circular Conduits Flowing Full and Partly Full**

Table 3. -- Velocity head and resistance computation factors for circular conduits flowing full and partly full

Column A: Relative depth of flow,  $d/D$   
 Column B: Relative velocity head  
 $h_v/D = \alpha V^2/2gD$ ,  $\alpha = 1.00$ ,  $Q/D^{2.5} = 1.0$   
 $V$  = Mean flow velocity  
 $\alpha$  = Kinetic energy correction factor  
 $g$  = Accel. due to gravity = 32.16 ft./sec./sec.  
 Column C: Resistance computation factor ( $K_m$ ) for the Manning equation,  $V = (1.486/n)(R)^{2/3}(S)^{1/2}$   
 $S_f = Q^2 n^2 / 2.208 R^{4/3} A^2 = K_m (n^2/D^{4/3})(Q/D^{2.5})^2$   
 $K_m = 0.4529 / (R/D)^{4/3} (A/D^2)^2$   
 $A$  = Flow area in conduit  
 $S_f$  = Friction slope  
 $R$  = Hydraulic radius  
 $n$  = Manning coefficient  
 Column D: Resistance computation factor ( $K_f$ ) for the Darcy equation,  $h_f = (f)(L/4R)(V^2/2g)$   
 $S_f = Q^2 f / 257.28 R A^2 = K_f (f)(Q/D^{2.5})^2$   
 $K_f = 0.003887 / (R/D)(A/D^2)^2$   
 $h_f$  = Friction head loss, ft.  
 $f$  = Darcy coefficient  
 $L$  = Length of conduit, ft.



(A)	(B)	(C)	(D)	(A)	(B)	(C)	(D)
Relative depth $d/D$	Relative velocity head $\alpha V^2/2gD$ $\alpha = 1.00$ $Q/D^{2.5} = 1.0$	Manning Eq. resistance computation factor $K_m$	Darcy Eq. resistance computation factor $K_f$	Relative depth $d/D$	Relative velocity head $\alpha V^2/2gD$ $\alpha = 1.00$ $Q/D^{2.5} = 1.0$	Manning Eq. resistance computation factor $K_m$	Darcy Eq. resistance computation factor $K_f$
1.00	0.02520	4.662	0.02520	0.85	0.03071	4.390	0.02532
0.99	.02529	4.293	.02371	.84	.03134	4.470	.02579
.98	.02544	4.174	.02326	.83	.03201	4.560	.02632
.97	.02565	4.104	.02301	.82	.03272	4.657	.02688
.96	.02589	4.061	.02288	.81	.03348	4.764	.02750
.95	.02618	4.037	.02284	.80	.03426	4.878	.02816
.94	.02648	4.028	.02287	.79	.03510	5.004	.02888
.93	.02683	4.033	.02296	.78	.03598	5.137	.02963
.92	.02720	4.046	.02310	.77	.03692	5.282	.03045
.91	.02761	4.071	.02330	.76	.03790	5.438	.03133
.90	.02805	4.105	.02353	.75	.03894	5.605	.03226
.89	.02852	4.145	.02380	.74	.04004	5.787	.03328
.88	.02902	4.195	.02412	.73	.04120	5.981	.03436
.87	.02955	4.251	.02448	.72	.04242	6.188	.03550
.86	.03011	4.317	.02487	.71	.04371	6.411	.03673

Source:

LD-294  
(3/20/07)

Page 1 of 3

DEPARTMENT OF TRANSPORTATION  
LOCATION AND DESIGN  
HYDRAULIC COMMENTARY FOR ENVIRONMENTAL PERMIT FOR CULVERTS

## LOCATION

Project :  
Route :  
PPMS :  
Station :  
City/County :  
Waterway :

## PREPARED BY

Name :  
Organization :  
Date :

1. Type and size of structure \_\_\_\_\_ Length \_\_\_\_\_  
Invert in \_\_\_\_\_ out \_\_\_\_\_ Height of cover \_\_\_\_\_ Drainage Area \_\_\_\_\_  
Design Discharge \_\_\_\_\_ Design Frequency \_\_\_\_\_ Design Headwater Elev. \_\_\_\_\_  
100-yr Discharge \_\_\_\_\_ 100-yr Headwater Elev. \_\_\_\_\_  
OHW elevation \_\_\_\_\_  
Outlet Protection \_\_\_\_\_

2. Temporary structures for construction \_\_\_\_\_  
\_\_\_\_\_  
\_\_\_\_\_

## 3. Applicable flood plain management criteria:

Note: Use **ONLY the one statement that is applicable and erase all the rest,** including this instruction and the FEMA delineation description information.

## For project within a FEMA delineated floodplain:

FEMA regulates flood level, flood velocity, and flow distribution and this project is within FEMA community panel number: \_\_\_\_\_ and Zone \_\_\_\_\_. This project complies with FEMA requirements because there will be no increase in flood levels, velocities or flow distribution. A copy of an excerpt from the aforementioned map panel showing the crossing site has been included.

FEMA regulates flood level, flood velocity, and flow distribution and this project is within FEMA community panel number: \_\_\_\_\_ and Zone \_\_\_\_\_. This project complies with FEMA requirements because a bridge/culvert will be replaced with a hydraulically equivalent replacement structure. A copy of an excerpt from the aforementioned map panel showing the crossing site has been included.

DEPARTMENT OF TRANSPORTATION  
LOCATION AND DESIGN  
HYDRAULIC COMMENTARY FOR ENVIRONMENTAL PERMIT FOR CULVERTS

For project permits in a FEMA floodplain carrying a **Zone A** (or **Zone X**) designation that does not have base flood elevations. In such instances, an increase in 100-year flood level not exceeding one foot is acceptable.

FEMA regulates flood level, flood velocity, and flow distribution and this project is within FEMA community panel number: \_\_\_\_\_ and Zone A (or X). This project complies with FEMA requirements because there will be no more than a one foot increase in flood levels, velocities and flow distribution will not be changed significantly. A copy of an excerpt from the aforementioned map panel showing the crossing site has been included.

For projects not within a FEMA floodplain, include the following statement:

FEMA regulates flood level, flood velocity and flood distributions and this project is not within a designated or delineated FEMA floodplain. The project complies because there are no FEMA requirements applicable within the project area.

#### 4. EROSION AND SEDIMENT CONTROL

An erosion and sediment control plan will be prepared and implemented in compliance with the Erosion and Sediment Control Law, the Erosion and Sediment Control Regulations, and VDOT's Annual Erosion and Sediment Control Standards and Specifications approved by the Department of Conservation and Recreation.

#### 5. STORMWATER MANAGEMENT

Design of this project will be in compliance with the Stormwater Management Act, the Stormwater Management Regulations, and VDOT's Annual Stormwater Management Standards and Specifications approved by the Department of Conservation and Recreation.

#### 6. COUNTERSINKING AND MULTIPLE BARRELL CULVERTS

Note: Use **ONLY the statements that are applicable and erase all the rest.**

The upstream and downstream inverts of culverts with diameters greater than 24" (or equivalent) will be countersunk a minimum of 6" below the stream bed.

The upstream and downstream inverts of culverts with diameters equal to or less than 24" (or equivalent) will be countersunk a minimum of 3" below the stream bed.

At least one barrel of a multiple barrel culvert structure will be countersunk a minimum of 6" for a diameter greater than 24" (or equivalent) or a minimum of 3" for a diameter equal to or less than 24" (or equivalent).

The width of the countersunk culvert barrel(s) receiving the low flow is approximately the width of the normal stream bed.

LD-294  
(3/20/07)

Page 3 of 3

DEPARTMENT OF TRANSPORTATION  
LOCATION AND DESIGN  
HYDRAULIC COMMENTARY FOR ENVIRONMENTAL PERMIT FOR CULVERTS

Low flow design measures have been implemented for multiple barrel culverts in which all barrels will be countersunk.

Culverts on bedrock will be countersunk a minimum of 3" below the stream bed.

Culverts on bedrock will be countersunk at the upstream end a minimum of 3" and at the downstream end stone step pools, low rock weirs or other measures will be constructed.

Countersinking of the culverts is not practicable due to \_\_\_\_\_ (See IIM-214.2 Section 4). See attached supporting documentation

7. IMPACT STATEMENT \_\_\_\_\_  
\_\_\_\_\_  
\_\_\_\_\_