

PR-5

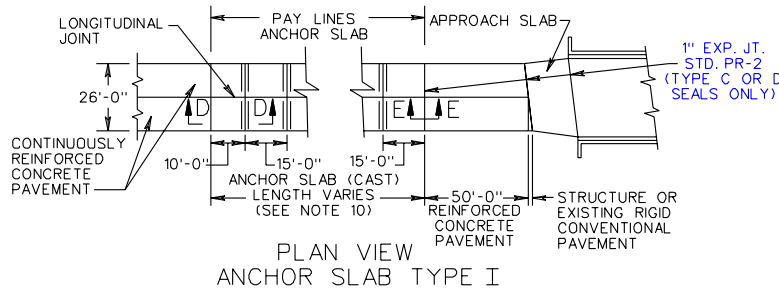

PLAN VIEW
ANCHOR SLAB TYPE I

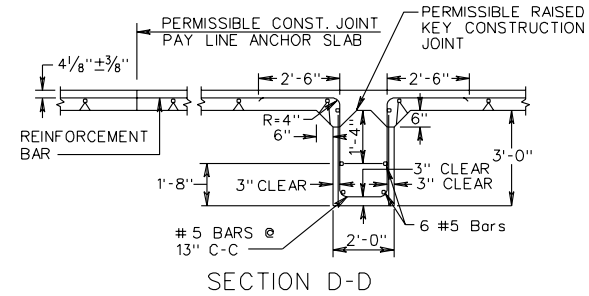

SECTION D-D

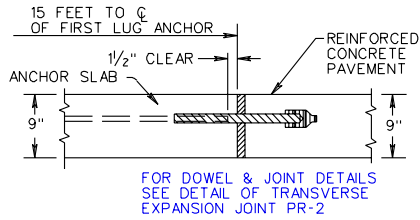

SECTION E-E
ANCHOR SLAB TYPE I

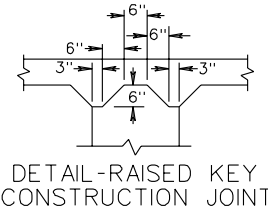

DETAIL-RAISED KEY
CONSTRUCTION JOINT

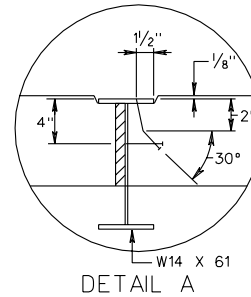

DETAIL A

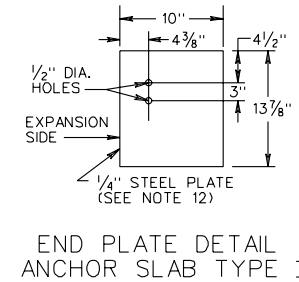

END PLATE DETAIL
ANCHOR SLAB TYPE II

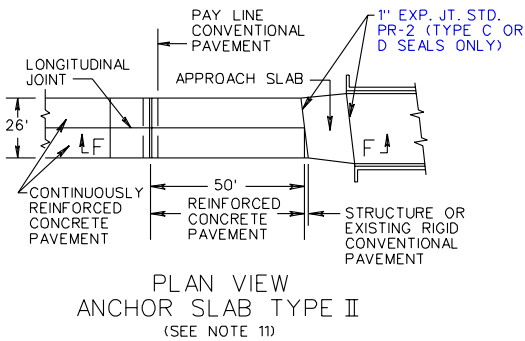

PLAN VIEW
ANCHOR SLAB TYPE II
(SEE NOTE 11)

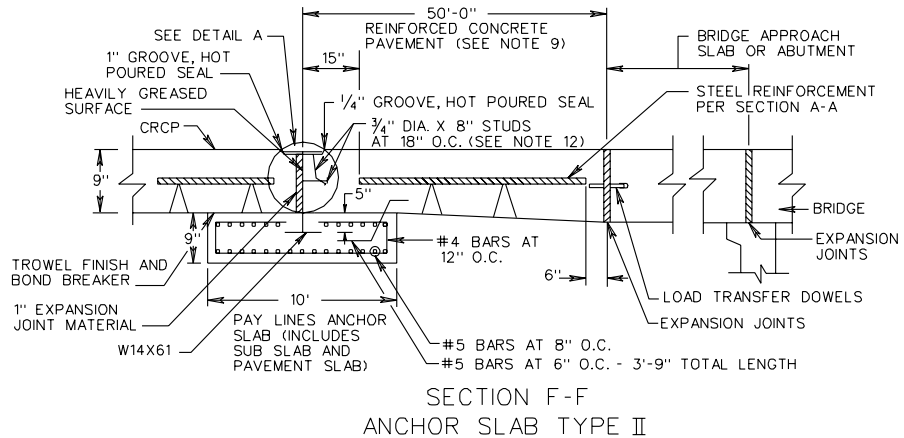

SECTION F-F
ANCHOR SLAB TYPE II

SHEET 2 OF 3

SEE SHEET 3 OF 3 FOR NOTES.

9" THICK CONTINUOUSLY REINFORCED CONCRETE PAVEMENT
14 FOOT TRAVEL LANE

REV. 7/03
301.14

VIRGINIA DEPARTMENT OF TRANSPORTATION

SPECIFICATION
REFERENCE

316