

PLAN VIEW  
ANCHOR SLAB TYPE I

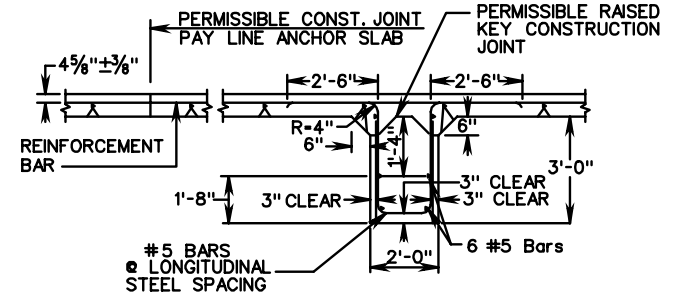

SECTION D-D

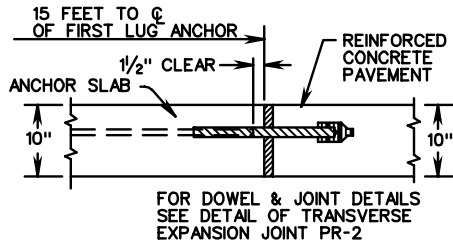

SECTION E-E  
ANCHOR SLAB TYPE I

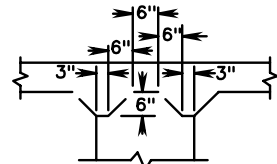

DETAIL-RAISED KEY  
CONSTRUCTION JOINT

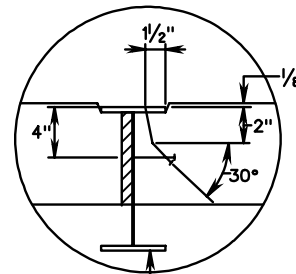

DETAIL A

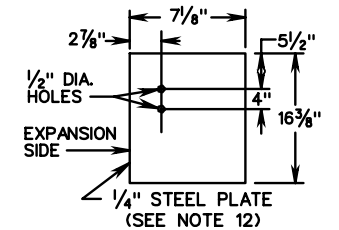

ANCHOR SLAB TYPE II  
END PLATE DETAIL

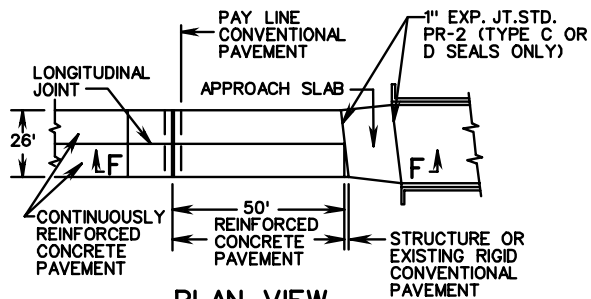

PLAN VIEW  
ANCHOR SLAB TYPE II  
(SEE NOTE 11)

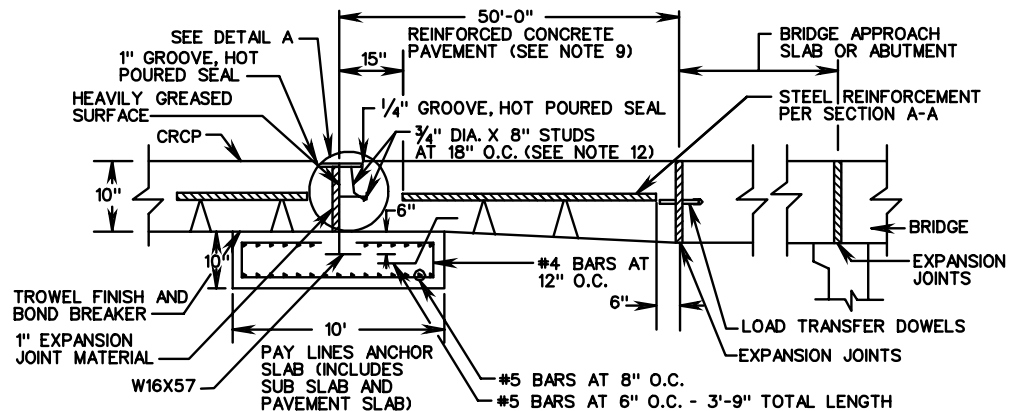

SECTION F-F  
ANCHOR SLAB TYPE II

SEE SHEET 3 OF 3 FOR NOTES

SHEET 2 OF 3

SPECIFICATION  
REFERENCE

316

# 10" THICK CONTINUOUSLY REINFORCED CONCRETE PAVEMENT 14 FOOT TRAVEL LANE

VIRGINIA DEPARTMENT OF TRANSPORTATION

REV. 1/04

301.17