

WM-1

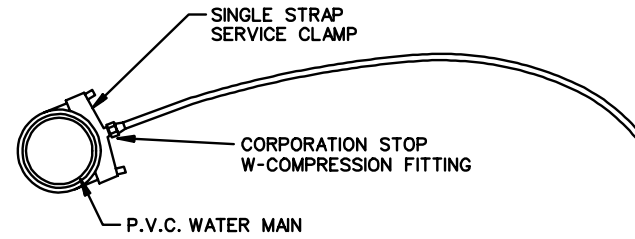

P.V.C. TAP INSTALLATION

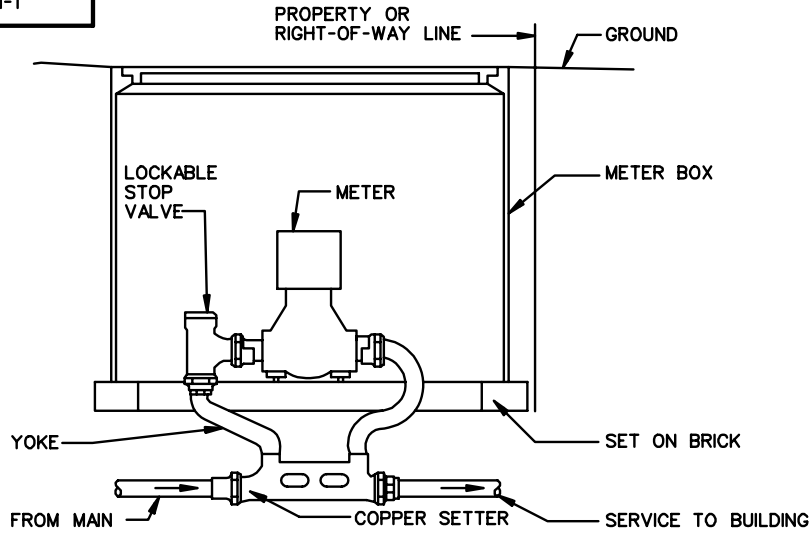
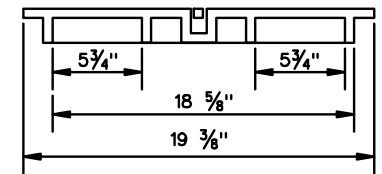

SECTION BB

NOTE:
DETAIL IS FOR 5/8" THRU
1" DISC METERS

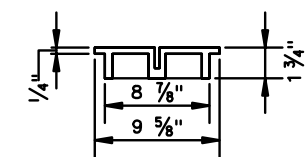
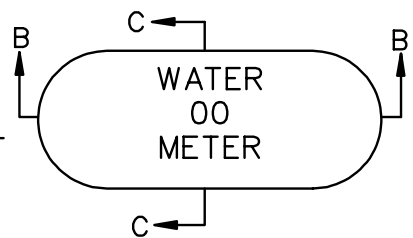
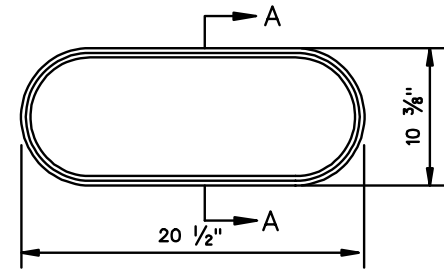

SECTION CC

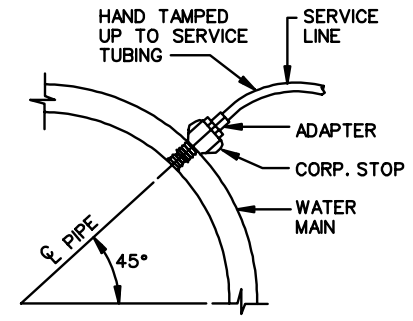

C.I./D.I. TAP INSTALLATION

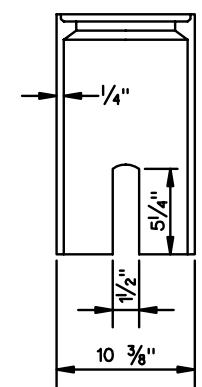
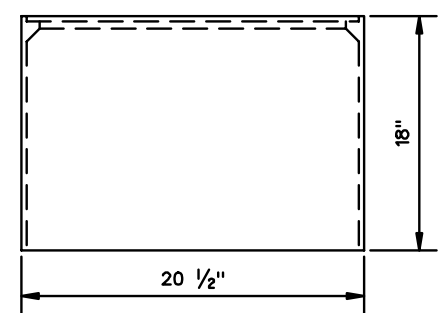

SECTION AA

WATER METER BOX
FOR 5/8" THRU 1" METER

CAST IRON SHALL CONFORM TO ASTM A-48 CLASS 30S
ALL COPPER FITTINGS SHALL BE FLARED TYPE

VDOT	
ROAD AND BRIDGE STANDARDS	
SHEET 1 OF 1	REVISION DATE
1408.01	

WATER METER AND BOX (WATER SERVICE LINES)

VIRGINIA DEPARTMENT OF TRANSPORTATION

SPECIFICATION REFERENCE