

STANDARD	TITLE	PAGE
CS-1, 1A	TYPICAL METHODS OF GRADING SIDE SLOPES	701.01
CS-2	SUGGESTED DRAINAGE TREATMENT AT BEGINNING OF FILLS	701.02
CS-2A	TYPICAL METHODS OF GRADING SIDE SLOPES	701.03
CS-3	TYPICAL METHODS OF GRADING SIDE SLOPES	701.04
CS-3A	TYPICAL METHODS OF GRADING SIDE SLOPES	701.05
CS-3B	TYPICAL METHODS OF GRADING SIDE SLOPES	701.06
CS-4	TYPICAL METHODS OF GRADING SIDE SLOPES	701.07
CS-4A	TYPICAL METHODS OF GRADING SIDE SLOPES	701.08
CS-4B	TYPICAL METHODS OF GRADING SIDE SLOPES	701.09
CS-4C	TYPICAL METHODS OF GRADING SIDE SLOPES	701.10
CS-4E	TYPICAL METHODS OF GRADING SIDE SLOPES	701.11
GS-10	MINIMUM DESIGN CRITERIA FOR TEMPORARY DETOURS (MOT)	702.01
GS-11	STANDARD SHOULDER DESIGN FOR ALL SYSTEMS EXCEPT LOCAL ROADS AND STREETS	702.02
GS-12	STANDARD SHOULDER DESIGN FOR LOCAL ROADS AND STREETS	702.03
GS-13	STANDARD GRADED MEDIAN DESIGNS	702.04

INDEX OF SHEETS
SECTION 700-GEOMETRIC DESIGN

VIRGINIA DEPARTMENT OF TRANSPORTATION



ROAD AND BRIDGE STANDARDS

REVISION DATE

SHEET 1 OF 1

700.01

THIS PAGE INTENTIONALLY LEFT BLANK



ROAD AND BRIDGE STANDARDS

SHEET 1 OF 1

REVISION DATE

700.02

VIRGINIA DEPARTMENT OF TRANSPORTATION

SPECIFICATION
REFERENCE

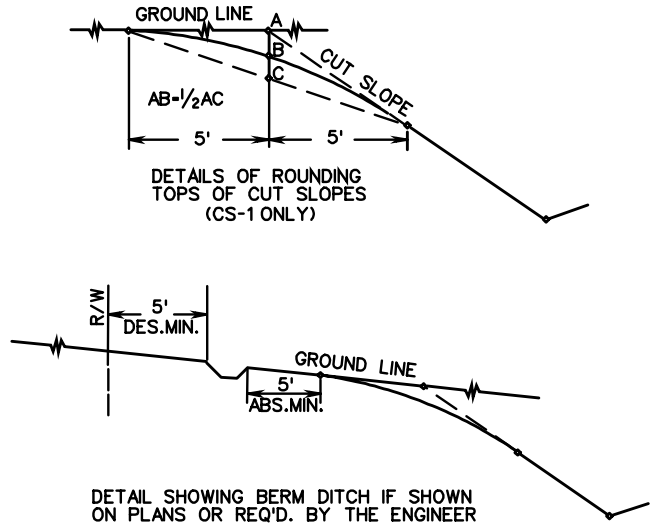

NOTES:

SLOPE ROUNDING (STD. CS-1) TO BE AS DETAILED ABOVE, UNLESS SPECIFICALLY EXCEPTED ON PROJECT TYPICAL SECTION(S).

SEE STANDARD CS-2A FOR SUGGESTED METHODS OF FINISHING SLOPES TO FIT VARIOUS CONDITIONS.

SEE STANDARD CS-2 FOR SUGGESTED METHOD OF TRANSITIONING FROM CUT TO FILL.

ALL SLOPES SHALL BE FINISHED IN ACCORDANCE WITH THIS PLAN AND NOTES HEREON. EXCEPTIONS: LACK OF RIGHT OF WAY, ROCK OUT-CROP, OR WHERE DESIRABLE TO SAVE TREES, SHRUBBERY, ETC., AS MAY BE DIRECTED BY THE ENGINEER. SHOULD THIS RESULT IN SURPLUS EXCAVATION MATERIAL, SUCH SURPLUS SHALL BE USED AS DIRECTED BY THE ENGINEER, IN LIEU OF BORROW, TO WIDEN FILLS, OR GRADE WITHIN THE RIGHT OF WAY. SHOULD IT RESULT IN INSUFFICIENT EXCAVATION MATERIAL, SUCH MATERIAL SHALL BE OBTAINED AS DIRECTED BY THE ENGINEER.

WHEN FOUND EXPEDIENT, STANDARD DITCH WIDTH AND DEPTH MAY BE INCREASED; THE DISTANCE BETWEEN BOTTOM OF DITCH AND MINIMUM RIGHT OF WAY LINE TO REMAIN AS SHOWN FOR STANDARD DITCH.

IN SHALLOW CUTS, WHERE POSSIBLE, KEEP THE CUT SLOPE, AT LEAST AS STEEP AS THE DITCH SLOPE BY WIDENING THE DITCH, HOLDING THE STANDARD DEPTH.

ST'D. CS-1: AS DETAILED HEREON WITH CUT SLOPE ROUNDING.
ST'D. CS-1A: AS DETAILED HEREON EXCEPT THAT CUT SLOPE ROUNDING IS TO BE ELIMINATED.

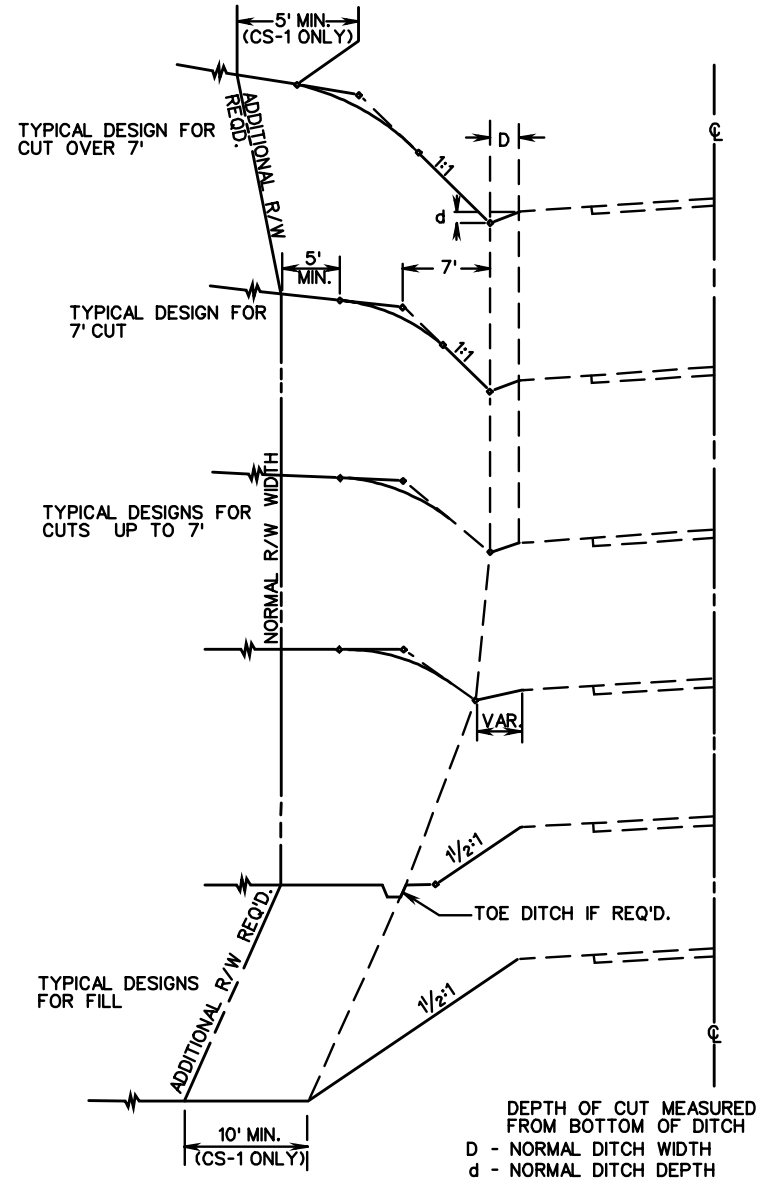

SPECIFICATION REFERENCE

303

TYPICAL METHODS OF GRADING SIDE SLOPES

VIRGINIA DEPARTMENT OF TRANSPORTATION

VDOT

ROAD AND BRIDGE STANDARDS

REVISION DATE

SHEET 1 OF 1

701.01

SUGGESTIONS FOR GRADING SIDE SLOPES AND ROADWAYS TO FIT VARIOUS CONDITIONS

APPLICABLE TO ALL SLOPES AND SLOPE STANDARDS

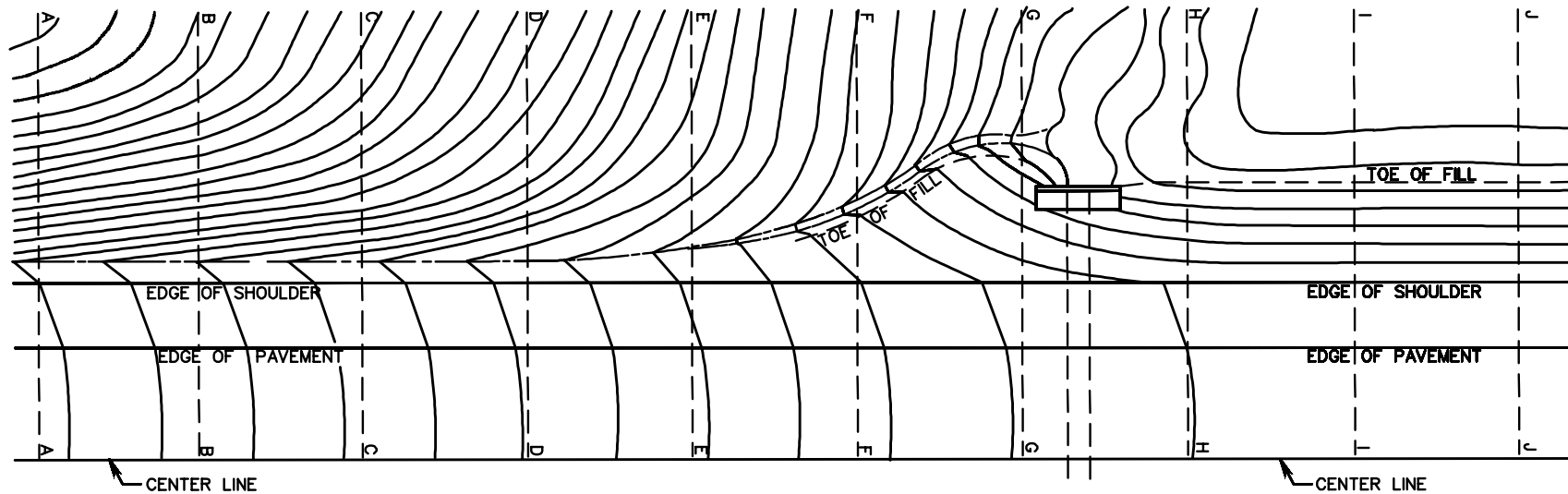
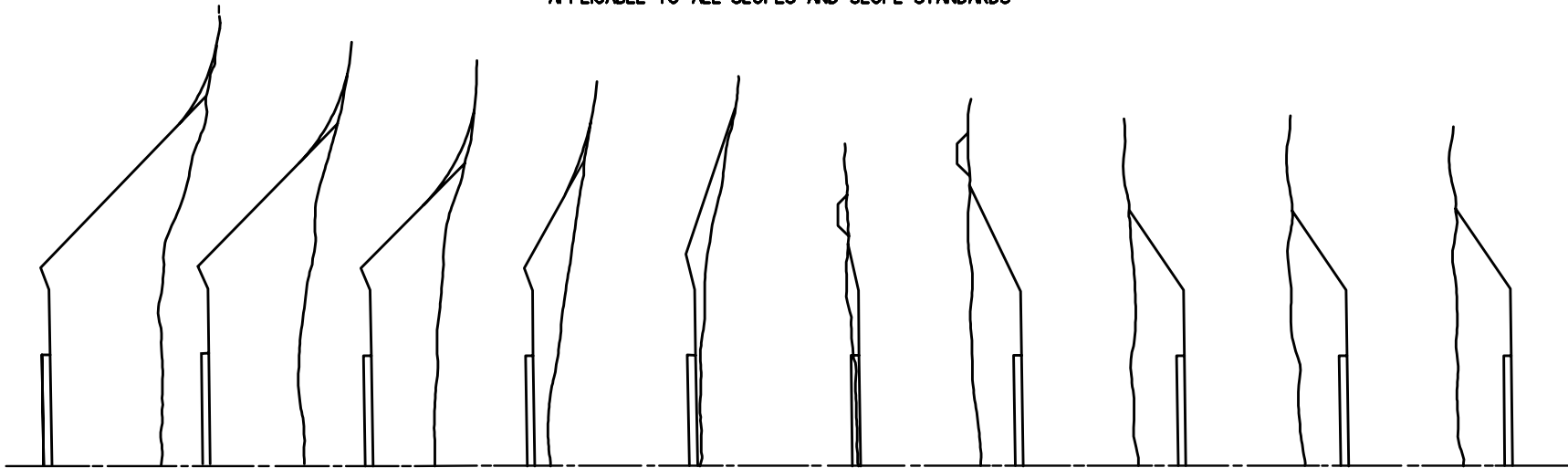

ROAD AND BRIDGE STANDARDS

SHEET 1 OF 1

REVISION DATE

701.02

SUGGESTED DRAINAGE TREATMENT

(AT BEGINNING OF FILLS)

VIRGINIA DEPARTMENT OF TRANSPORTATION

SPECIFICATION REFERENCE

303

SUGGESTIONS FOR GRADING SIDE SLOPES AND ROADWAYS TO FIT VARIOUS CONDITIONS

APPLICABLE TO ALL SLOPES AND SLOPE STANDARDS

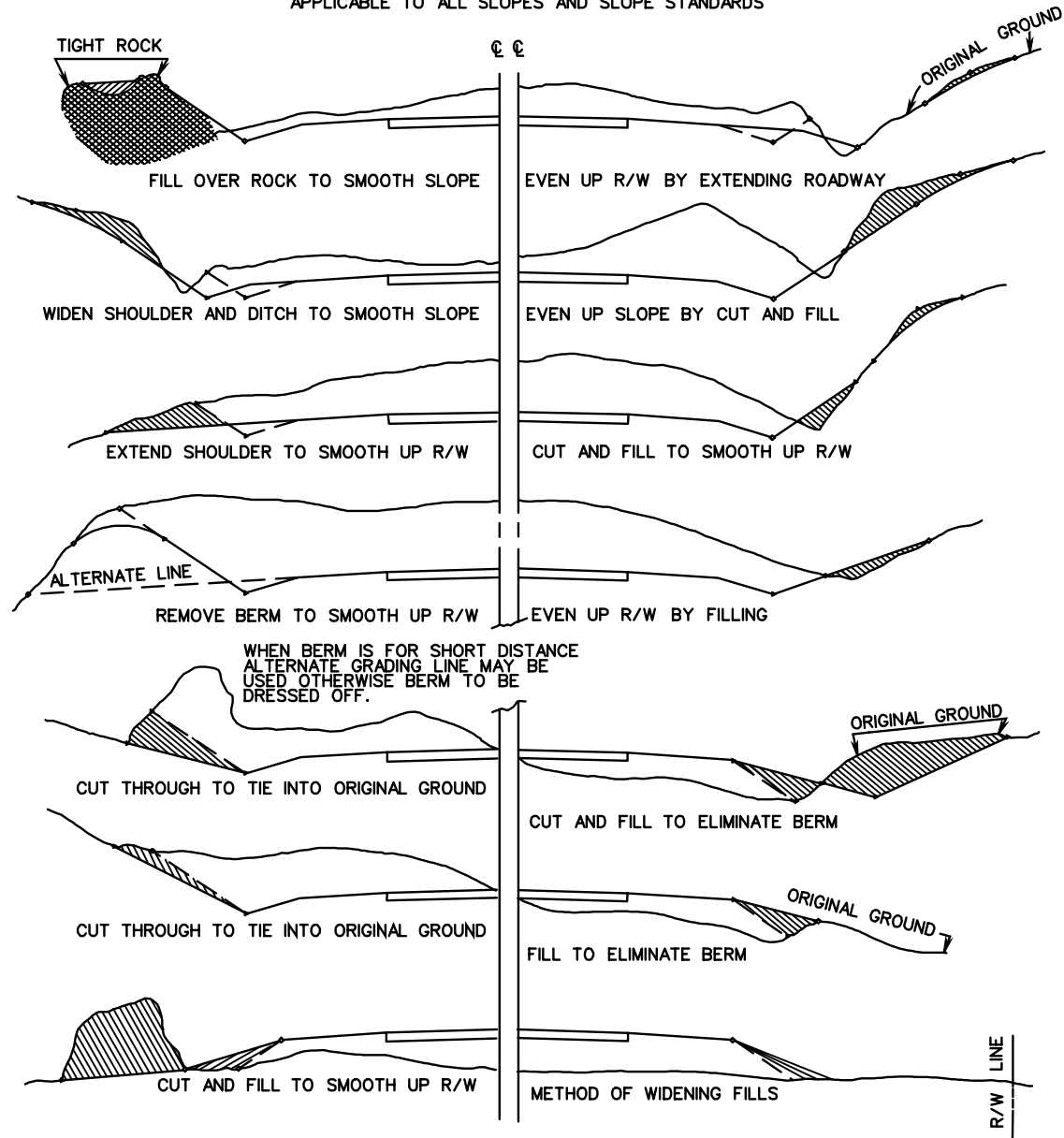

SPECIFICATION REFERENCE

303

TYPICAL METHODS OF GRADING SIDE SLOPES

VIRGINIA DEPARTMENT OF TRANSPORTATION

VDOT

ROAD AND BRIDGE STANDARDS

REVISION DATE

SHEET 1 OF 1

701.03

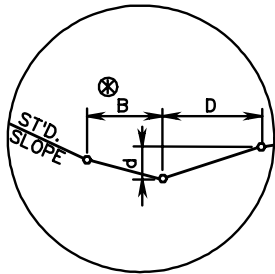

DETAIL A

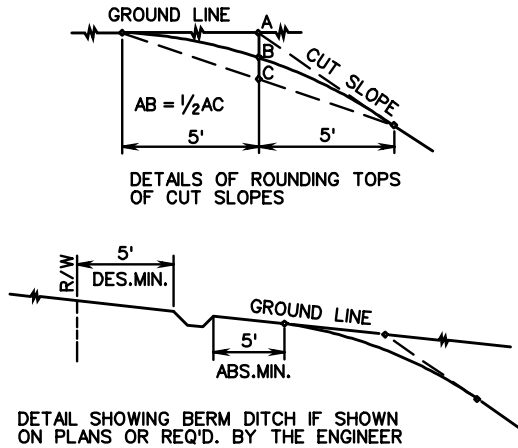

NOTES:

SLOPE ROUNDING TO BE IN ACCORDANCE WITH ABOVE DETAIL UNLESS SPECIFICALLY EXCEPTED ON PROJECT TYPICAL SECTION(S).

SEE STANDARD CS-2A FOR SUGGESTED METHODS OF FINISHING SLOPES TO FIT VARIOUS CONDITIONS.

SEE STANDARD CS-2 FOR SUGGESTED METHOD OF TRANSITIONING FROM CUT TO FILL.

ALL SLOPES SHALL BE FINISHED IN ACCORDANCE WITH THIS PLAN AND NOTES HEREON. EXCEPTIONS: LACK OF RIGHT OF WAY, ROCK OUT-CROP, OR WHERE DESIRABLE TO SAVE TREES, SHRUBBERY, ETC., AS MAY BE DIRECTED BY THE ENGINEER. SHOULD THIS RESULT IN SURPLUS EXCAVATION MATERIAL, SUCH SURPLUS SHALL BE USED AS DIRECTED BY THE ENGINEER, IN LIEU OF BORROW, TO WIDEN FILLS, OR GRADE WITHIN THE RIGHT OF WAY. SHOULD IT RESULT IN INSUFFICIENT EXCAVATION MATERIAL, SUCH MATERIAL SHALL BE OBTAINED AS DIRECTED BY THE ENGINEER.

IN SHALLOW CUTS, WHERE POSSIBLE, KEEP THE CUT SLOPE AT LEAST AS STEEP AS THE DITCH SLOPE BY WIDENING THE DITCH, HOLDING THE STANDARD DEPTH.

MAXIMUM SLOPE RATE SHALL NOT BE CHANGED MORE THAN TWICE IN A CUT.

IF METHOD SHOWN FOR TRANSITIONING FROM 1/2:1 SLOPES AND VICE VERSA, PRODUCES TRANSITIONS TOO SHORT, THEY SHALL BE INCREASED TO 100' IN LENGTH.

WHEN RECOVERABLE AREAS ARE NOT INDICATED ON THE TYPICAL SECTION, THE FILL SLOPE IS TO BE APPLIED TO THE NORMAL SHOULDER WIDTH BREAK POINT.

⊗ SEE TYPICAL SECTION FOR DITCH WIDTH.

* SEE TYPICAL SECTION FOR RECOVERABLE AREA WIDTH TO BE USED WITH NORMAL FILL SHOULDER WIDTH.

WHEN FOUND EXPEDIENT, STANDARD DITCH WIDTH AND DEPTH MAY BE INCREASED. THE DISTANCE BETWEEN BOTTOM OF DITCH AND MINIMUM OF RIGHT OF WAY LINE TO REMAIN AS SHOWN FOR STANDARD DITCH.

IN CUTS UP 400' IN LENGTH 1/2:1 SLOPES MAY BE CARRIED THROUGH REGARDLESS OF DEPTH, PROVIDED RIGHT OF WAY IS AVAILABLE.

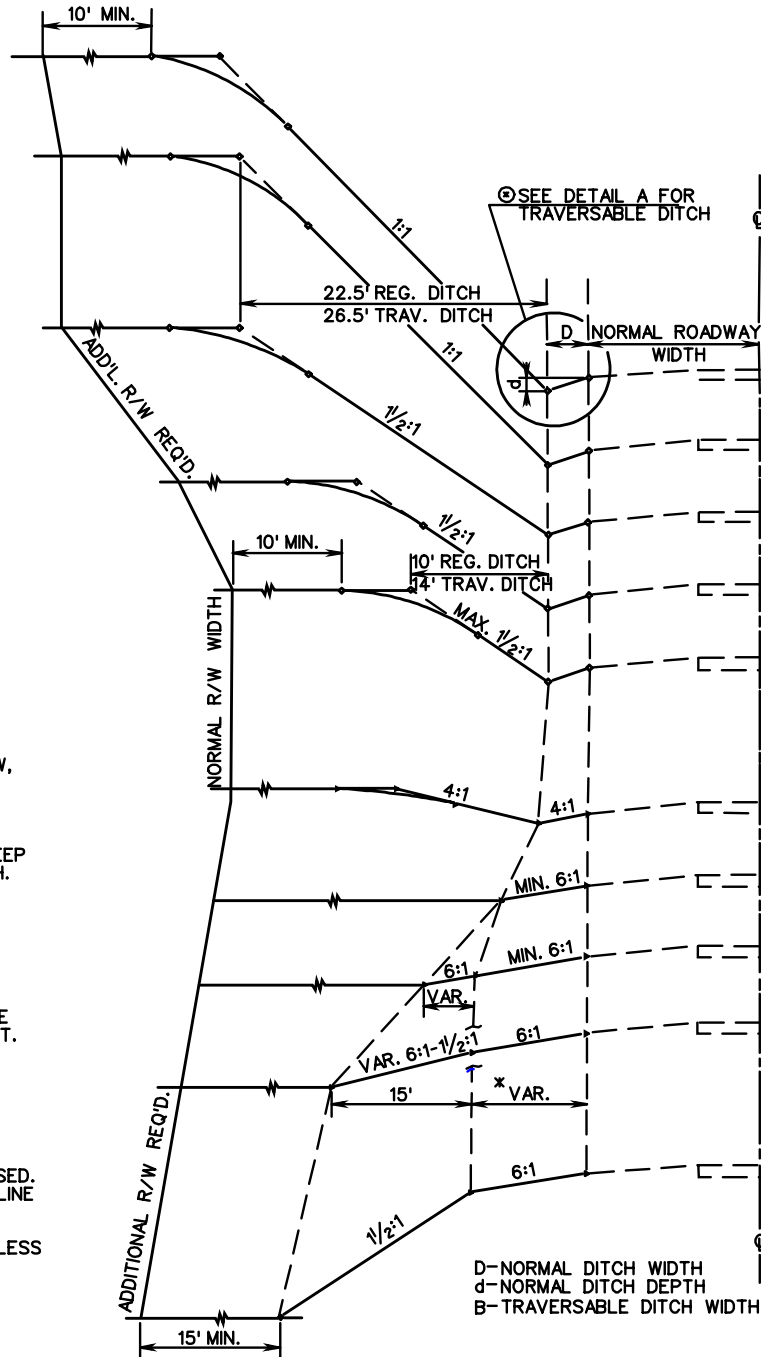

ROAD AND BRIDGE STANDARDS

SHEET 1 OF 1

REVISION DATE

701.04

TYPICAL METHODS OF GRADING SIDE SLOPES

VIRGINIA DEPARTMENT OF TRANSPORTATION

SPECIFICATION REFERENCE

303

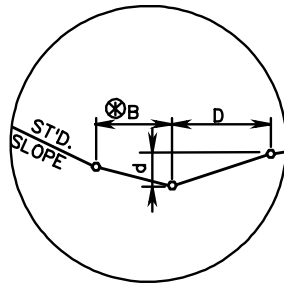

DETAIL A

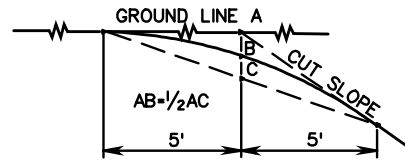

DETAILS OF ROUNDING TOPS OF CUT SLOPES

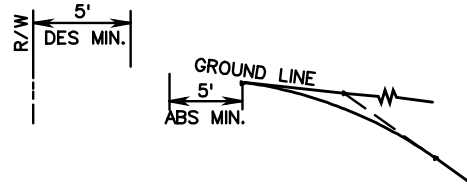

DETAIL SHOWING BERM DITCH IF SHOWN ON PLANS OR REQ'D BY THE ENGINEER

NOTES:

SLOPE ROUNDING TO BE IN ACCORDANCE WITH ABOVE DETAIL UNLESS SPECIFICALLY EXCEPTED ON PROJECT TYPICAL SECTION(S).

SEE STANDARD CS-2A FOR SUGGESTED METHODS OF FINISHING SLOPES TO FIT VARIOUS CONDITIONS.

SEE STANDARD CS-2 FOR SUGGESTED METHOD OF TRANSITIONING FROM CUT TO FILL.

ALL SLOPES SHALL BE FINISHED IN ACCORDANCE WITH THIS PLAN AND NOTES HEREON. EXCEPTIONS: LACK OF RIGHT OF WAY, ROCK OUT-CROP, OR WHERE DESIRABLE TO SAVE TREES, SHRUBBERY, ETC., AS MAY BE DIRECTED BY THE ENGINEER. SHOULD THIS RESULT IN SURPLUS EXCAVATION MATERIAL, SUCH SURPLUS SHALL BE USED AS DIRECTED BY THE ENGINEER, IN LIEU OF BORROW, TO WIDEN FILLS, OR GRADE WITHIN THE RIGHT OF WAY. SHOULD IT RESULT IN INSUFFICIENT EXCAVATION MATERIAL, SUCH MATERIAL SHALL BE OBTAINED AS DIRECTED BY THE ENGINEER.

WHEN FOUND EXPEDIENT, STANDARD DITCH WIDTH AND DEPTH MAY BE INCREASED; THE DISTANCE BETWEEN BOTTOM OF DITCH AND MINIMUM RIGHT OF WAY LINE TO REMAIN AS SHOWN FOR STANDARD DITCH.

IN SHALLOW CUTS, WHERE POSSIBLE, KEEP THE CUT SLOPE AT LEAST AS STEEP AS THE DITCH SLOPE BY WIDENING THE DITCH, HOLDING THE STANDARD DEPTH.

WHEN RECOVERABLE AREAS ARE NOT INDICATED ON THE TYPICAL SECTION, THE FILL SLOPE IS TO BE APPLIED TO THE NORMAL SHOULDER WIDTH BREAK POINT.

⊗ SEE TYPICAL SECTION FOR TRAVERSABLE DITCH WIDTH AND SLOPE.

* SEE TYPICAL SECTION FOR RECOVERABLE AREA WIDTH TO BE USED WITH NORMAL FILL SHOULDER WIDTH.

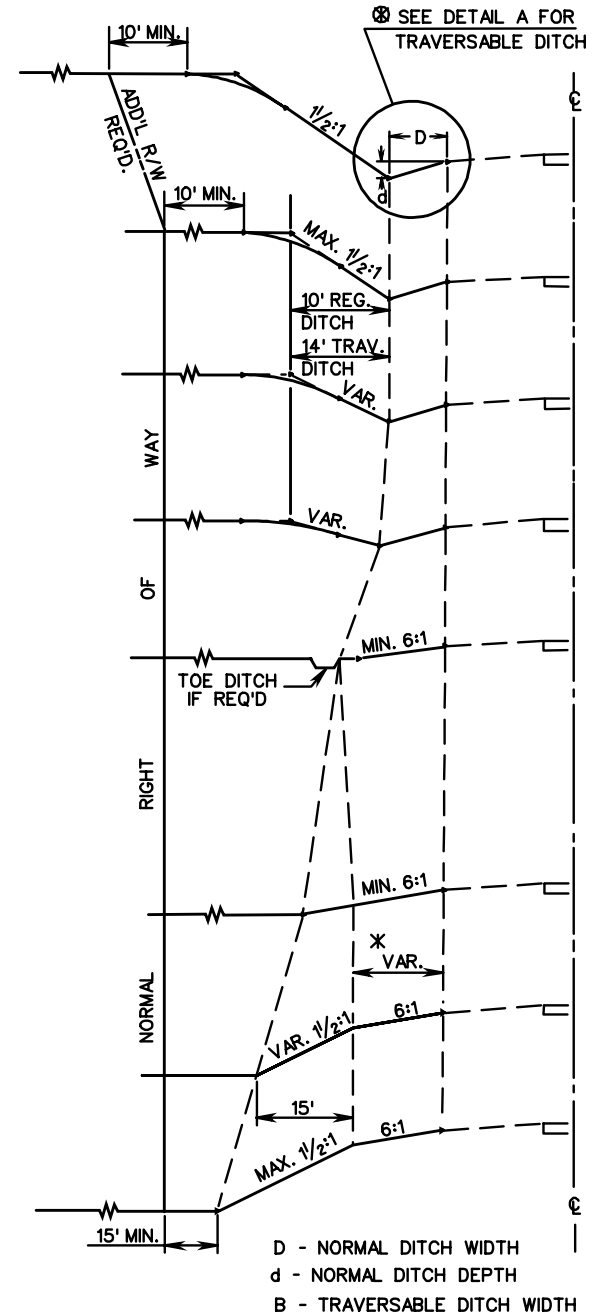

SPECIFICATION REFERENCE

303

TYPICAL METHODS OF GRADING SIDE SLOPES

VIRGINIA DEPARTMENT OF TRANSPORTATION

VDOT

ROAD AND BRIDGE STANDARDS

REVISION DATE

SHEET 1 OF 1

701.05

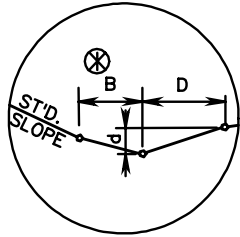

DETAIL A

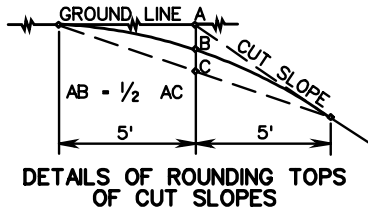

DETAILS OF ROUNDING TOPS OF CUT SLOPES

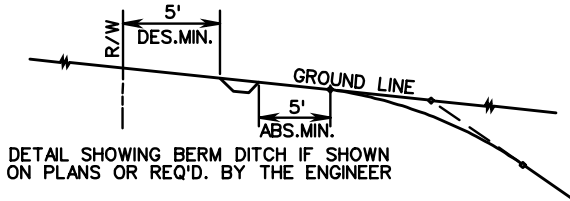

DETAIL SHOWING BERM DITCH IF SHOWN ON PLANS OR REQ'D. BY THE ENGINEER

NOTES:

SLOPE ROUNDING TO BE IN ACCORDANCE WITH ABOVE DETAIL UNLESS SPECIFICALLY EXCEPTED ON PROJECT TYPICAL SECTION(S).

SEE STANDARD CS-2A FOR SUGGESTED METHODS OF FINISHING SLOPES TO FIT VARIOUS CONDITIONS.

SEE STANDARD CS-2 FOR SUGGESTED METHOD OF TRANSITIONING FROM CUT TO FILL.

ALL SLOPES SHALL BE FINISHED IN ACCORDANCE WITH THIS PLAN AND NOTES HEREON. EXCEPTIONS: LACK OF RIGHT OF WAY, ROCK OUT-CROP, OR WHERE DESIRABLE TO SAVE TREES, SHRUBBERY, ETC., AS MAY BE DIRECTED BY THE ENGINEER. SHOULD THIS RESULT IN SURPLUS EXCAVATION MATERIAL, SUCH SURPLUS SHALL BE USED AS DIRECTED BY THE ENGINEER, IN LIEU OF BORROW, TO WIDEN FILLS, OR GRADE WITHIN THE RIGHT OF WAY. SHOULD IT RESULT IN INSUFFICIENT EXCAVATION MATERIAL, SUCH MATERIAL SHALL BE OBTAINED AS DIRECTED BY THE ENGINEER.

WHEN FOUND EXPEDIENT, STANDARD DITCH WIDTH AND DEPTH MAY BE INCREASED; THE DISTANCE BETWEEN BOTTOM OF DITCH AND MINIMUM RIGHT OF WAY LINE TO REMAIN AS SHOWN FOR STANDARD DITCH.

IN SHALLOW CUTS, WHERE POSSIBLE, KEEP THE CUT SLOPE AT LEAST AS STEEP AS THE DITCH SLOPE BY WIDENING THE DITCH, HOLDING THE STANDARD DEPTH.

IN CUTS UP TO 400' IN LENGTH 1/2:1 SLOPES MAY BE CARRIED THROUGH REGARDLESS OF DEPTH, PROVIDED RIGHT OF WAY IS AVAILABLE.

MAXIMUM SLOPE RATE SHALL NOT BE CHANGED MORE THAN TWICE IN A CUT.

IF METHOD SHOWN FOR TRANSITIONING FROM 1/2:1 TO 1:1 SLOPES AND VICE VERSA PRODUCES TRANSITIONS TOO SHORT, THEY SHALL BE INCREASED TO 100' IN LENGTH.

WHEN RECOVERABLE AREAS ARE NOT INDICATED ON THE TYPICAL SECTION, THE FILL SLOPE IS TO BE APPLIED TO THE NORMAL SHOULDER WIDTH BREAK POINT.

⊗ SEE TYPICAL SECTION FOR DITCH WIDTH

* SEE TYPICAL SECTION FOR RECOVERABLE AREA WIDTH TO BE USED WITH NORMAL FILL SHOULDER WIDTH

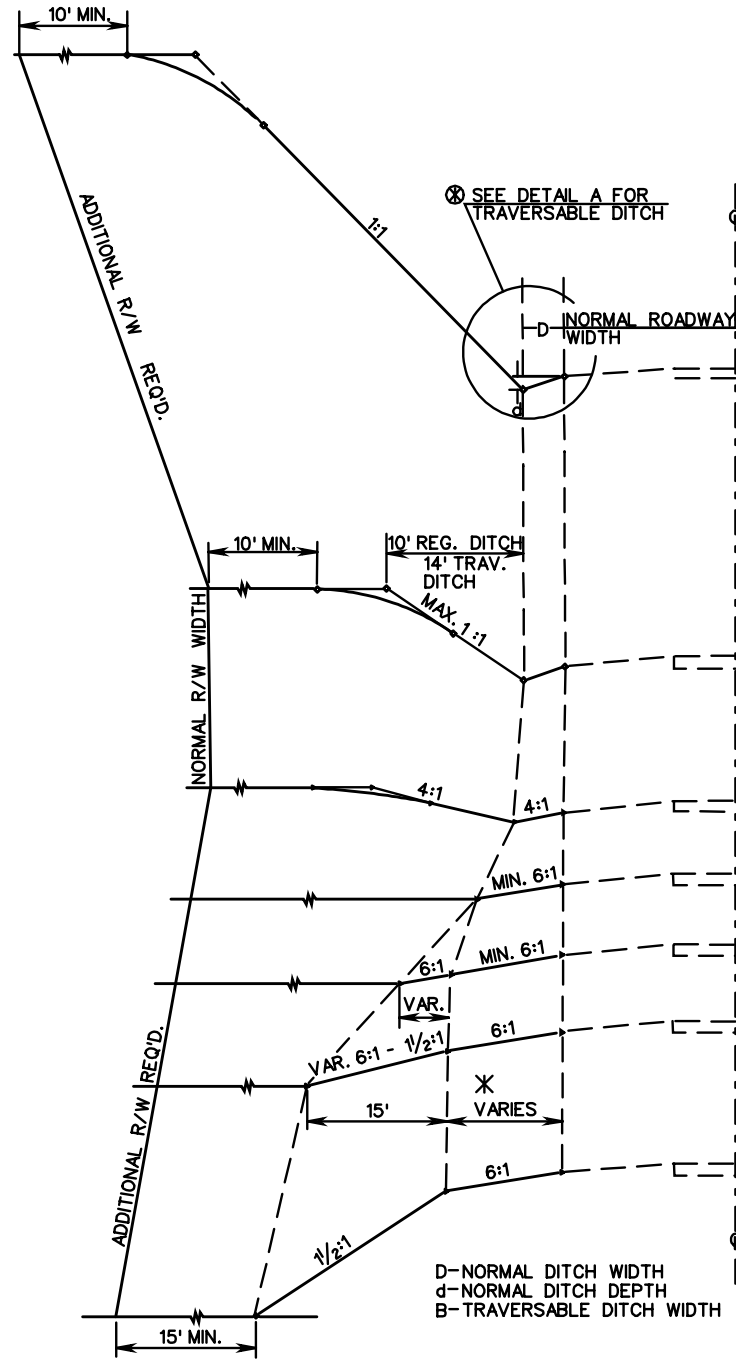

ROAD AND BRIDGE STANDARDS

SHEET 1 OF 1

REVISION DATE

701.06

TYPICAL METHODS OF GRADING SIDE SLOPES

VIRGINIA DEPARTMENT OF TRANSPORTATION

SPECIFICATION REFERENCE

303

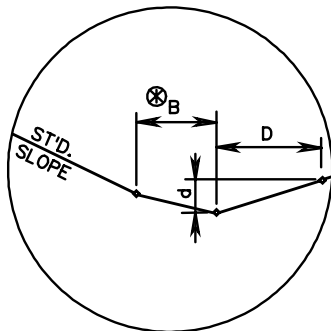

DETAIL A

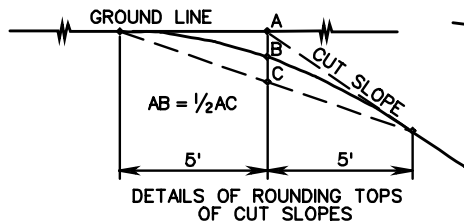

DETAILS OF ROUNDING TOPS OF CUT SLOPES

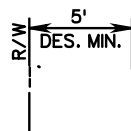

DETAIL SHOWING BERM DITCH IF SHOWN ON PLANS OR REQ'D. BY THE ENGINEER

NOTES:

SLOPE ROUNDING TO BE IN ACCORDANCE WITH ABOVE DETAIL UNLESS SPECIFICALLY EXCEPTED ON PROJECT TYPICAL SECTION(S).

SEE STANDARD CS-2A FOR SUGGESTED METHODS OF FINISHING SLOPES TO FIT VARIOUS CONDITIONS.

SEE STANDARD CS-2 FOR SUGGESTED METHOD OF TRAITIONING FROM CUT TO FILL.

ALL SLOPES SHALL BE FINISHED IN ACCORDANCE WITH THIS PLAN AND NOTES HEREON. EXCEPTIONS: LACK OF RIGHT OF WAY, ROCK OUT-CROP, OR WHERE DESIRABLE TO SAVE TREES, SHRUBBERY, ETC., AS MAY BE DIRECTED BY THE ENGINEER. SHOULD THIS RESULT IN SURPLUS EXCAVATION MATERIAL, SUCH SURPLUS SHALL BE USED AS DIRECTED BY THE ENGINEER, IN LIEU OF BORROW, TO WIDEN FILLS, OR GRADE WITHIN THE RIGHT OF WAY. SHOULD IT RESULT IN INSUFFICIENT EXCAVATION MATERIAL, SUCH MATERIAL SHALL BE OBTAINED AS DIRECTED BY THE ENGINEER.

WHEN FOUND EXPEDIENT, STANDARD DITCH WIDTH AND DEPTH MAY BE INCREASED; THE DISTANCE BETWEEN BOTTOM OF DITCH AND MINIMUM RIGHT OF WAY LINE TO REMAIN AS SHOWN FOR STANDARD DITCH.

IN SHALLOW CUTS, WHERE POSSIBLE, KEEP THE CUT SLOPE AT LEAST AS STEEP AS THE DITCH SLOPE BY WIDENING THE DITCH, HOLDING THE STANDARD DEPTH.

WHEN RECOVERABLE AREAS ARE NOT INDICATED ON THE TYPICAL SECTION, THE FILL SLOPE IS TO BE APPLIED TO NORMAL SHOULDER WIDTH BREAK POINT.

⊗ SEE TYPICAL SECTION FOR TRAVERSABLE DITCH WIDTH AND SLOPE.

* SEE TYPICAL SECTION FOR RECOVERABLE AREA WIDTH TO BE USED WITH NORMAL FILL SHOULDER WIDTH.

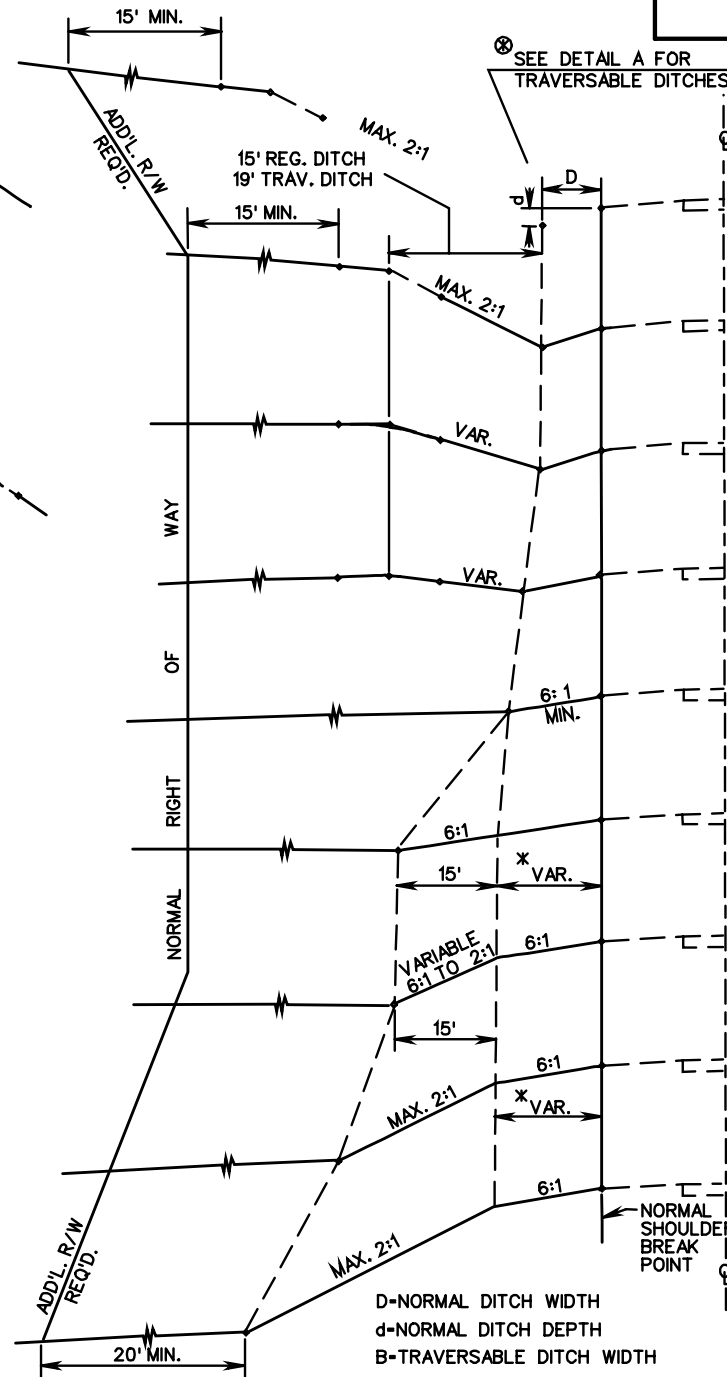

D-NORMAL DITCH WIDTH
d-NORMAL DITCH DEPTH
B-TRAVERSABLE DITCH WIDTH

SPECIFICATION REFERENCE

303

TYPICAL METHODS OF GRADING SIDE SLOPES

VIRGINIA DEPARTMENT OF TRANSPORTATION

VDOT

ROAD AND BRIDGE STANDARDS

REVISION DATE

SHEET 1 OF 1

701.07

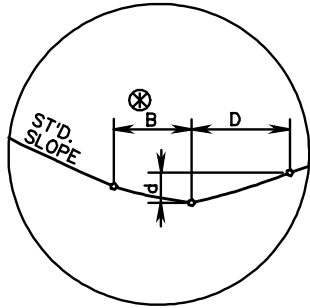

DETAIL A

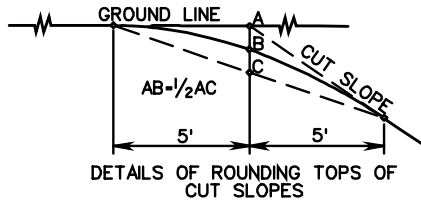

DETAILS OF ROUNDING TOPS OF CUT SLOPES

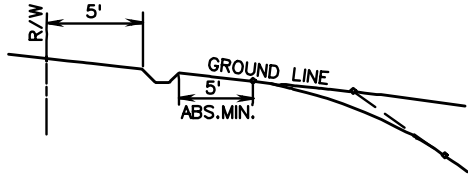

DETAIL SHOWING BERM DITCH IF SHOWN ON PLANS OR REQ'D. BY THE ENGINEER

NOTES:

SLOPE ROUNDING TO BE IN ACCORDANCE WITH ABOVE DETAIL UNLESS SPECIFICALLY EXCEPTED ON PROJECT TYPICAL SECTION(S).

SEE STANDARD CS-2A FOR SUGGESTED METHODS OF FINISHING SLOPES TO FIT VARIOUS CONDITIONS.

SEE STANDARD CS-2 FOR SUGGESTED METHODS OF TRANSITIONING FROM CUT TO FILL.

ALL SLOPES SHALL BE FINISHED IN ACCORDANCE WITH THIS PLAN AND NOTES HEREON. EXCEPTIONS: LACK OF RIGHT OF WAY, ROCK OUT-CROP, OR WHERE DESIRABLE TO SAVE TREES, SHRUBBERY, ETC., AS MAY BE DIRECTED BY THE ENGINEER. SHOULD THIS RESULT IN SURPLUS EXCAVATION MATERIAL, SUCH SURPLUS SHALL BE USED AS DIRECTED BY THE ENGINEER, IN LIEU OF BORROW, TO WIDEN FILLS, OR GRADE WITHIN THE RIGHT OF WAY. SHOULD IT RESULT IN INSUFFICIENT EXCAVATION MATERIAL, SUCH MATERIAL SHALL BE OBTAINED AS DIRECTED BY THE ENGINEER.

WHEN FOUND EXPEDIENT, STANDARD DITCH WIDTH AND DEPTH MAY BE INCREASED; THE DISTANCE BETWEEN BOTTOM OF DITCH AND MINIMUM RIGHT OF WAY LINE TO REMAIN AS SHOWN FOR STANDARD DITCH.

IN SHALLOW CUTS, WHERE POSSIBLE, KEEP THE CUT SLOPE AT LEAST AS STEEP AS THE DITCH SLOPE BY WIDENING THE DITCH, HOLDING THE STANDARD DEPTH.

IN CUTS UP TO 400' IN LENGTH 1/2:1 SLOPES MAY BE CARRIED THROUGH REGARDLESS OF DEPTH, PROVIDED RIGHT OF WAY IS AVAILABLE.

MAXIMUM SLOPE RATE SHALL NOT BE CHANGED MORE THAN TWICE IN A CUT. IF METHOD SHOWN FOR TRANSITIONING FROM 2:1 TO 1/2:1 SLOPES AND VICE VERSA PRODUCES TRANSITIONS TOO SHORT, THEY SHALL BE INCREASED TO 100' IN LENGTH.

* SEE TYPICAL SECTIONS FOR RECOVERABLE AREA WIDTH WHEN RECOVERABLE AREAS ARE NOT INDICATED ON THE TYPICAL SECTION, THE FILL SLOPE IS TO BE APPLIED TO THE NORMAL SHOULDER WIDTH BREAK POINT.

⊗ SEE TYPICAL SECTION FOR TRAVERSABLE DITCH WIDTH AND SLOPE.

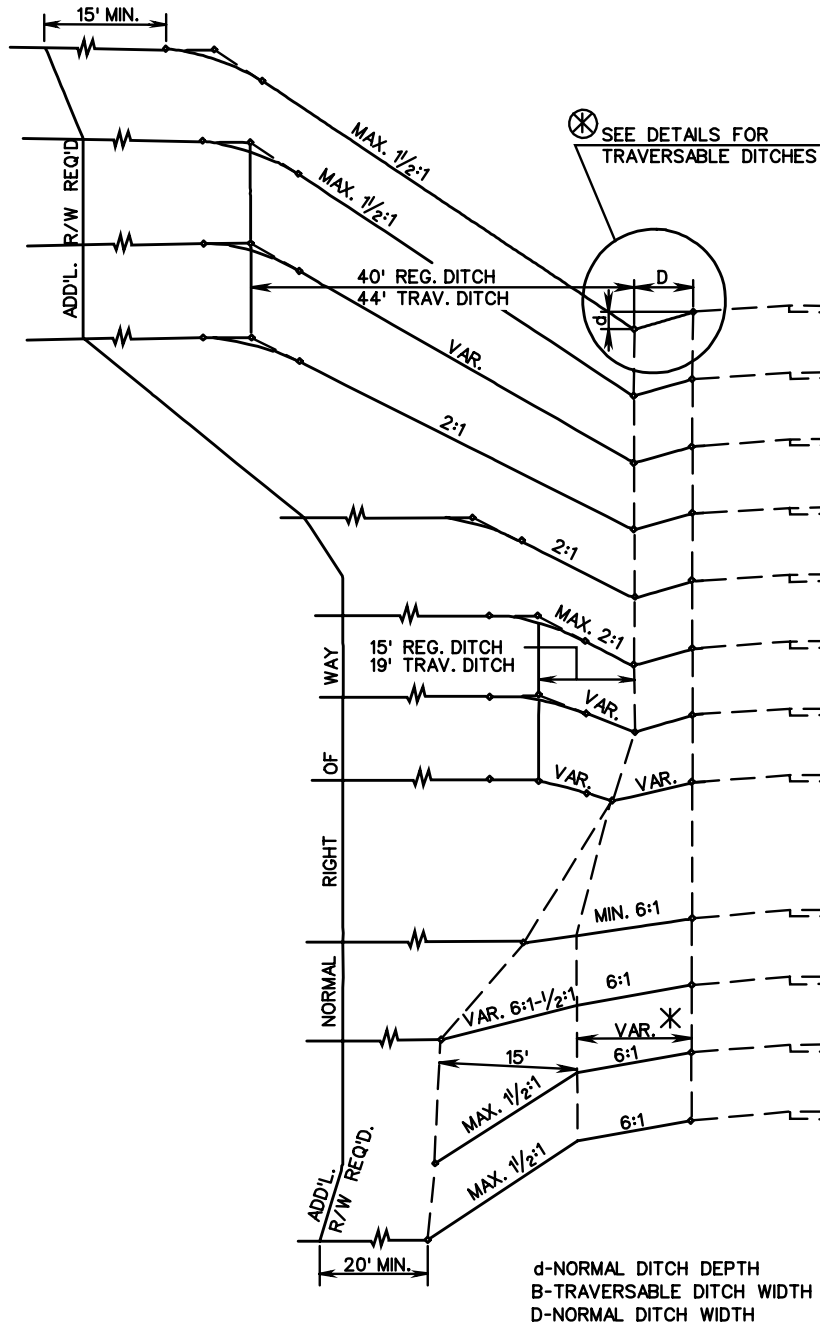

d-NORMAL DITCH DEPTH
B-TRAVERSABLE DITCH WIDTH
D-NORMAL DITCH WIDTH



ROAD AND BRIDGE STANDARDS

TYPICAL METHODS OF GRADING SIDE SLOPES

SPECIFICATION REFERENCE

SHEET 1 OF 1

REVISION DATE

303

701.08

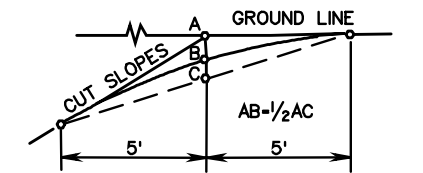
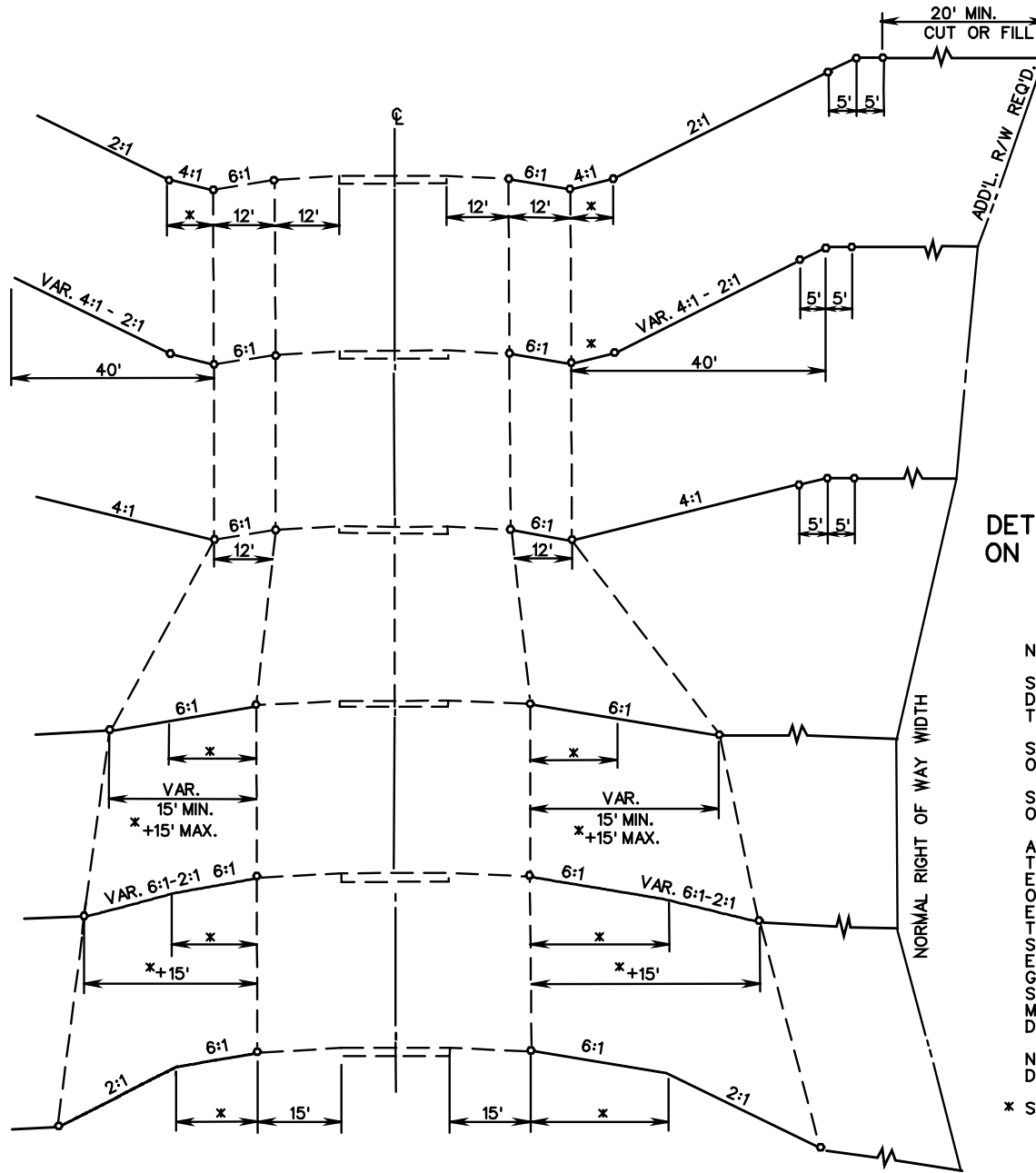

DETAIL OF ROUNDING TOPS OF CUT SLOPES

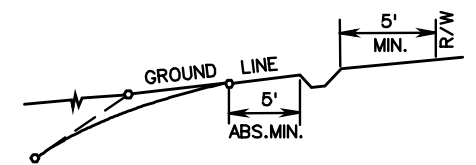

DETAIL SHOWING BERM DITCH IF SHOWN ON PLANS OR REQ'D. BY THE ENGINEER

NOTES:

SLOPE ROUNDING TO BE IN ACCORDANCE WITH ABOVE DETAIL UNLESS SPECIFICALLY EXCEPTED ON PROJECT TYPICAL SECTION(S).

SEE STANDARD CS-2A FOR SUGGESTED METHODS OF FINISHING SLOPES TO FIT VARIOUS CONDITIONS.

SEE STANDARD CS-2 FOR SUGGESTED METHOD OF TRANSITIONING FROM CUT TO FILL.

ALL SLOPES SHALL BE FINISHED IN ACCORDANCE WITH THIS PLAN AND NOTES HEREON. EXCEPTIONS: LACK OF RIGHT OF WAY, ROCK OUT-CROP OR WHERE DESIRABLE TO SAVE TREES, SHRUBBERY, ETC., AS MAY BE DIRECTED BY THE ENGINEER. SHOULD THIS RESULT IN SURPLUS EXCAVATION MATERIAL, SUCH SURPLUS SHALL BE USED AS DIRECTED BY THE ENGINEER, IN LEIU OF BORROW, TO WIDEN FILLS, OR GRADE WITHIN THE RIGHT OF WAY. SHOULD IT RESULT IN INSUFFICIENT EXCAVATION MATERIAL, SUCH MATERIAL SHALL BE OBTAINED AS DIRECTED BY THE ENGINEER.

NORMAL GUARDRAIL OFFSET TO BE AS SHOWN FOR DETAILS OF TRANSITIONING SEE ST'D. GR-INS.

* SEE TYPICAL SECTION FOR RECOVERABLE AREA WIDTH.

SPECIFICATION REFERENCE
303

TYPICAL METHODS OF GRADING SIDE SLOPES

VIRGINIA DEPARTMENT OF TRANSPORTATION

VDOT	
ROAD AND BRIDGE STANDARDS	
REVISION DATE	SHEET 1 OF 1
	701.09

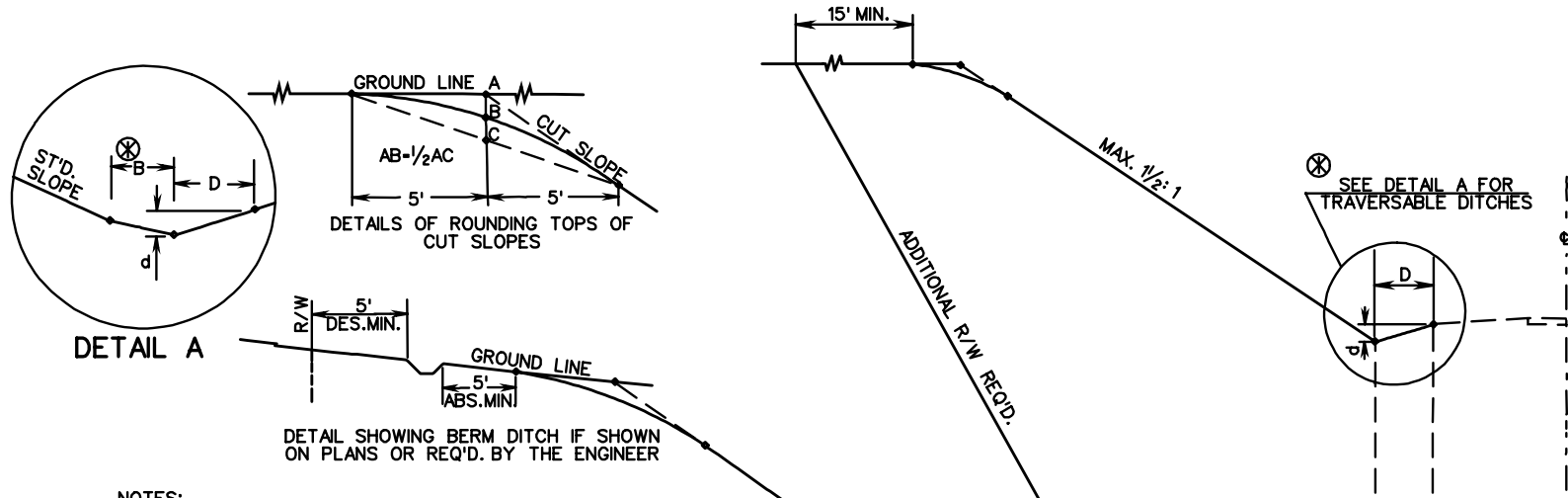

- NOTES:**
- SLOPE ROUNDING TO BE IN ACCORDANCE WITH ABOVE DETAIL UNLESS SPECIFICALLY EXCEPTED ON PROJECT TYPICAL SECTION(S).
 - SEE STANDARD CS-2A FOR SUGGESTED METHODS OF FINISHING SLOPES TO FIT VARIOUS CONDITIONS.
 - SEE STANDARD CS-2 FOR SUGGESTED METHOD OF TRANSITIONING FROM CUT TO FILL.
 - ALL SLOPES SHALL BE FINISHED IN ACCORDANCE WITH THIS PLAN AND NOTES HEREON. EXCEPTIONS: LACK OF RIGHT OF WAY, ROCK OUT-CROP, OR WHERE DESIRABLE TO SAVE TREES, SHRUBBERY, ETC., AS MAY BE DIRECTED BY THE ENGINEER. SHOULD THIS RESULT IN SURPLUS EXCAVATION MATERIAL, SUCH SURPLUS SHALL BE USED AS DIRECTED BY THE ENGINEER, IN LIEU OF BORROW, TO WIDEN FILLS, OR GRADE WITHIN THE RIGHT OF WAY. SHOULD IT RESULT IN INSUFFICIENT EXCAVATION MATERIAL, SUCH MATERIAL SHALL BE OBTAINED AS DIRECTED BY THE ENGINEER.
 - WHEN FOUND EXPEDIENT, STANDARD DITCH WIDTH AND DEPTH MAY BE INCREASED; THE DISTANCE BETWEEN BOTTOM OF DITCH AND MINIMUM RIGHT OF WAY LINE TO REMAIN AS SHOWN FOR STANDARD DITCH.
 - IN SHALLOW CUTS, WHERE POSSIBLE, KEEP THE CUT SLOPE AT LEAST AS STEEP AS THE DITCH SLOPE BY WIDENING THE DITCH, HOLDING THE STANDARD DEPTH.
 - IN CUTS UP TO 400' IN LENGTH $\frac{1}{2}:1$ SLOPES MAY BE CARRIED THROUGH REGARDLESS OF DEPTH, PROVIDED RIGHT OF WAY IS AVAILABLE.
 - MAXIMUM SLOPE RATE SHALL NOT BE CHANGED MORE THAN TWICE IN A CUT.
 - IF METHOD SHOWN FOR TRANSITIONING FROM $\frac{1}{2}:1$ TO $1:1$ SLOPES AND VICE VERSA PRODUCES TRANSITIONS TOO SHORT, THEY SHALL BE INCREASED TO 100' IN LENGTH.
 - * SEE TYPICAL SECTION FOR RECOVERABLE AREA WIDTH WHEN RECOVERABLE AREAS ARE NOT INDICATED ON THE TYPICAL SECTION, THE FILL SLOPE IS TO BE APPLIED TO THE NORMAL SHOULDER WIDTH BREAK POINT.
 - ⊗ SEE TYPICAL SECTION FOR TRAVERSABLE DITCH WIDTH AND SLOPE.

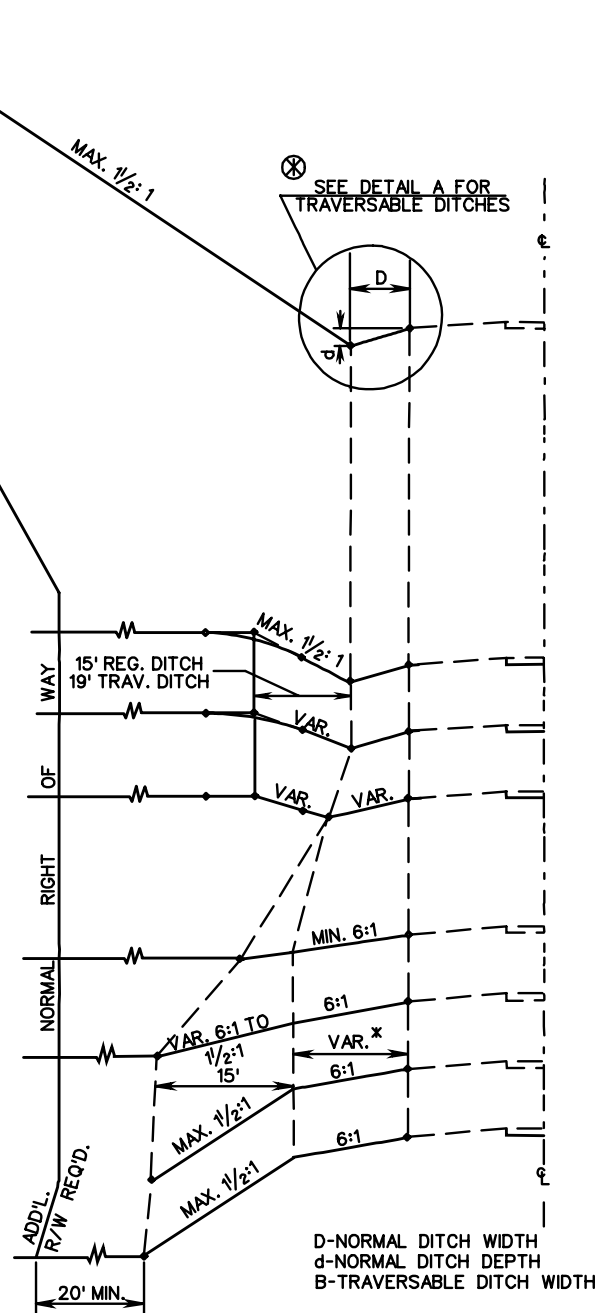

ROAD AND BRIDGE STANDARDS

SHEET 1 OF 1

REVISION DATE

701.10

TYPICAL METHODS OF GRADING SIDE SLOPES

VIRGINIA DEPARTMENT OF TRANSPORTATION

SPECIFICATION REFERENCE

303

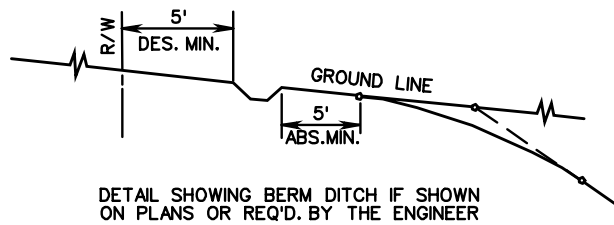
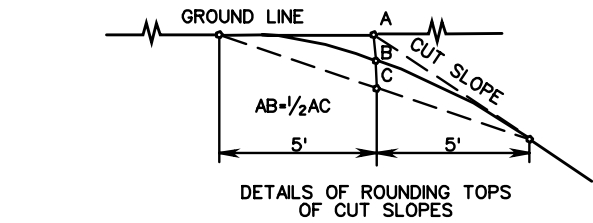

NOTES:

SLOPE ROUNDING TO BE AS DETAILED ABOVE, UNLESS SPECIFICALLY EXCEPTED ON PROJECT TYPICAL SECTION(S).

SEE STANDARD CS-2A FOR SUGGESTED METHODS OF FINISHING SLOPES TO FIT VARIOUS CONDITIONS.

SEE STANDARD CS-2 FOR SUGGESTED METHOD OF TRANSITIONING FROM CUT TO FILL.

ALL SLOPES SHALL BE FINISHED IN ACCORDANCE WITH THIS PLAN AND NOTES HEREON. EXCEPTIONS: LACK OF RIGHT OF WAY, ROCK OUT-CROP, OR WHERE DESIRABLE TO SAVE TREES, SHRUBBERY, ETC., AS MAY BE DIRECTED BY THE ENGINEER. SHOULD THIS RESULT IN SURPLUS SHALL BE USED AS DIRECTED BY THE ENGINEER, IN LIEU OF BORROW, TO WIDEN FILLS, OR GRADE WITHIN THE RIGHT OF WAY. SHOULD IT RESULT IN INSUFFICIENT EXCAVATION MATERIAL, SUCH MATERIAL SHALL BE OBTAINED AS DIRECTED BY THE ENGINEER.

* SEE TYPICAL SECTION FOR RECOVERABLE AREA WIDTH TO BE USED WITH NORMAL FILL SHOULDER WIDTH.

WHEN RECOVERABLE AREAS ARE NOT INDICATED ON THE TYPICAL SECTION, THE FILL SLOPE IS TO BE APPLIED TO THE NORMAL SHOULDER WIDTH BREAK POINT.

⊗ SEE TYPICAL SECTION FOR TRAVERSABLE DITCH WIDTH AND SLOPE.

SEE STANDARD PLAN GS-13 FOR GRADED MEDIAN.

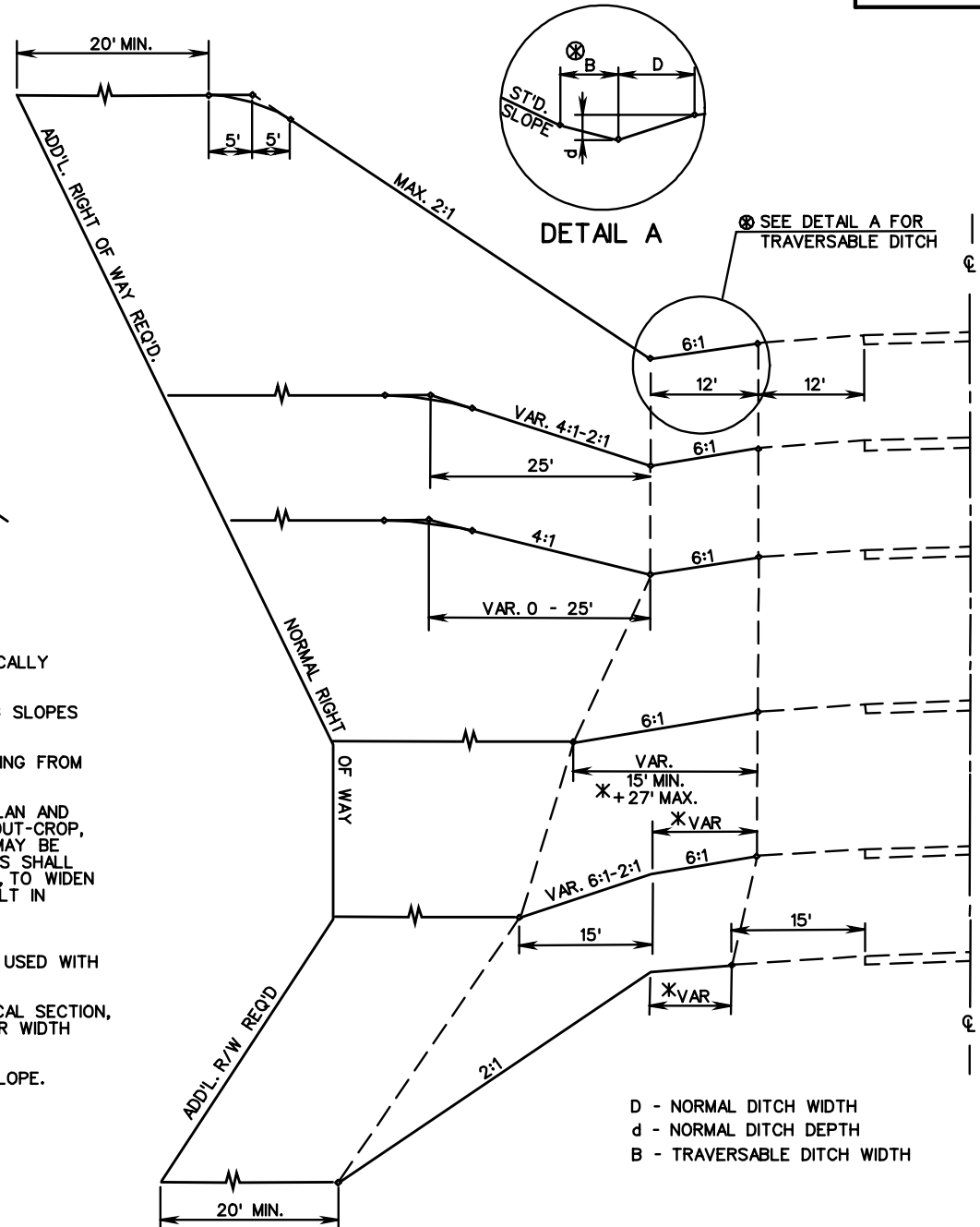

D - NORMAL DITCH WIDTH
 d - NORMAL DITCH DEPTH
 B - TRAVERSABLE DITCH WIDTH

SPECIFICATION REFERENCE
303

TYPICAL METHODS OF GRADING SIDE SLOPES

VIRGINIA DEPARTMENT OF TRANSPORTATION

VDOT	
ROAD AND BRIDGE STANDARDS	
REVISION DATE	SHEET 1 OF 1
	701.11

THIS PAGE INTENTIONALLY LEFT BLANK



ROAD AND BRIDGE STANDARDS

SHEET 1 OF 1

REVISION DATE

701.12

VIRGINIA DEPARTMENT OF TRANSPORTATION

SPECIFICATION
REFERENCE

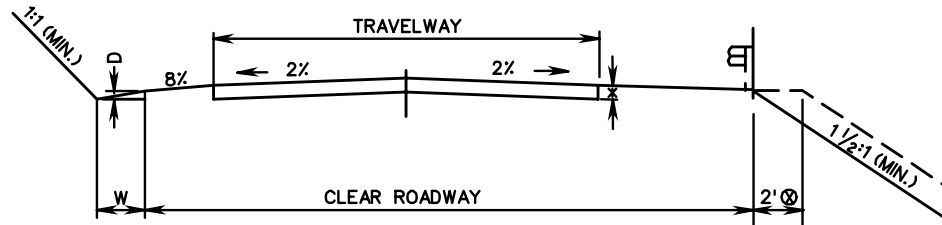

* SEE PLANS FOR BASE DEPTH AND TYPE AND PAVED SURFACE TREATMENT WHERE REQUIRED.

TYPICAL SECTION

⊗ FOR GUARDRAIL:
ADD 2' TO 4' SHOULDERS
ADD 3' TO ALL OTHER SHOULDERS

BRIDGE WIDTH = APPROACH ROADWAY WIDTH (CLEAR ROADWAY).

**WIDTHS FOR TWO WAY TRAFFIC
(LESSER WIDTH MAY BE USED FOR ONE-WAY)**

TYPE	CURRENT ADT	* TRAVELWAY WIDTH	SURFACE		MIN. ROADWAY SHOULDER TO SHOULDER ⊗	DITCH WIDTH (W)	DITCH DEPTH (D)	PAY ITEM
			UNPAVED	PAVED				
A	0-250	18'	✓		22'	4'	16"	LF.
B	251-750	20'	✓		24' ABS. 30' DES.	4'	16"	LF.
C	751-2000	22'		✓	30' ABS. 34' DES.	4'	16"	* *
D	2001-5500	24'		✓	40'	4'	16"	* *
E	5501-15,000	24'		✓	40'	4'	16"	* *
F	15,000-ABOVE	24'		✓	40'	6'	18"	* *

* CURVES TO BE WIDENED IN ACCORDANCE WITH ST'D. TC-5.01R.
** PAID FOR BY INDIVIDUAL QUANTITIES.

GEOMETRICS

DESIGN SPEED M.P.H.	20	30	40	50	60	70
MIN. RADII	108' R	251' R	465' R	760' R	1204' R	1821' R
MAX. % GRADE	DES.	8%	7%	7%	6%	5%
	ABS.	16%	14%	13%	10%	6%
STOPPING SIGHT DISTANCE	DES.	125'	200'	325'	475'	650'
	MIN.			305'	425'	570'
MAXIMUM SUPERELEVATION	8%	8%	8%	8%	8%	8%

IF GEOMETRICS AND WIDTHS SHOWN IN THESE CHARTS ARE GREATER THAN THE FINISHED CONTRACT DESIGN, APPROVAL MAY BE GRANTED BY THE DEPARTMENT FOR LESSER VALUES.

SPECIFICATION REFERENCE

510

**MINIMUM DESIGN CRITERIA FOR TEMPORARY DETOURS
(MAINTENANCE OF TRAFFIC)**

VIRGINIA DEPARTMENT OF TRANSPORTATION

VDOT

ROAD AND BRIDGE STANDARDS

REVISION DATE

SHEET 1 OF 1

702.01

GRADED MEDIAN SHOULDERS

OUTSIDE SHOULDERS

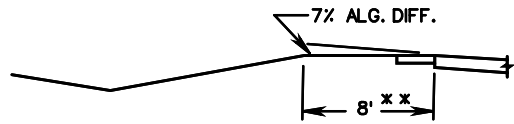

** WHERE MAINLINE IS 6 OR MORE LANES GRADED SHOULDER WIDTH IS TO BE THE SAME AS THAT SHOWN FOR FILL SHOULDER FOR INDEPENDENT GRADING.

HIGH SIDE - SUPERELEVATED

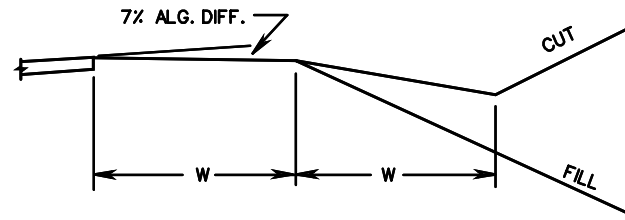

HIGH SIDE - SUPERELEVATED

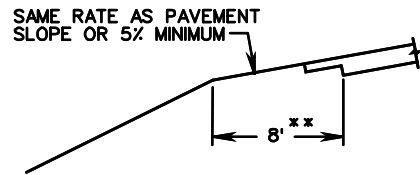

LOW SIDE - SUPERELEVATED

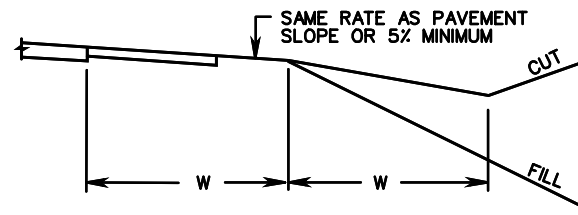

LOW SIDE - SUPERELEVATED

NOTE: FOR WIDTH OF SHOULDERS AND DITCHES (W) SEE GEOMETRIC DESIGN STANDARDS.



ROAD AND BRIDGE STANDARDS

SHEET 1 OF 1

REVISION DATE

702.02

STANDARD SHOULDER DESIGN FOR ALL SYSTEMS EXCEPT LOCAL ROADS AND STREETS

VIRGINIA DEPARTMENT OF TRANSPORTATION

TANGENT SECTION

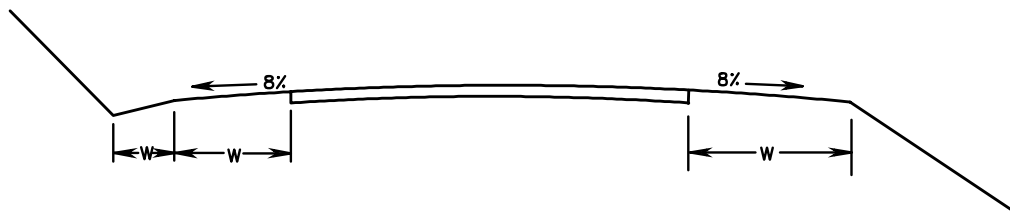

FOR WIDTHS OF SHOULDERS AND DITCHES (W)
SEE STANDARDS..

SUPERELEVATED SECTION

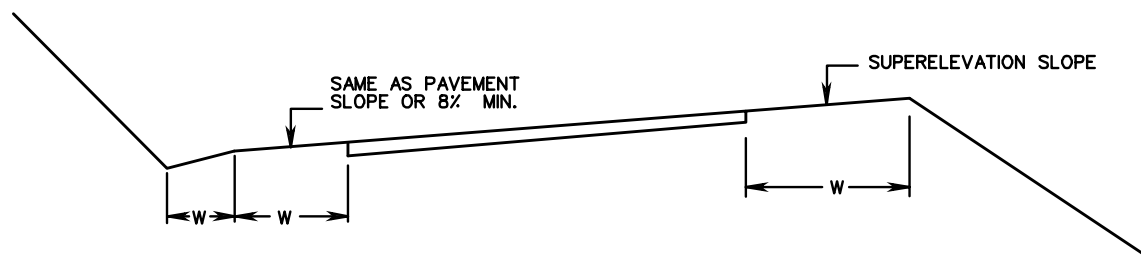

FOR WIDTHS OF SHOULDERS AND DITCHES (W)
SEE STANDARDS.

SPECIFICATION
REFERENCE

STANDARD SHOULDER DESIGN FOR LOCAL ROADS & STREETS

VIRGINIA DEPARTMENT OF TRANSPORTATION

VDOT

ROAD AND BRIDGE STANDARDS

REVISION DATE

SHEET 1 OF 1

702.03

MEDIAN EDGES OF SHOULDER AT SAME OR APPROXIMATELY SAME ELEVATION

(GRADING TO CENTER OF MEDIAN)

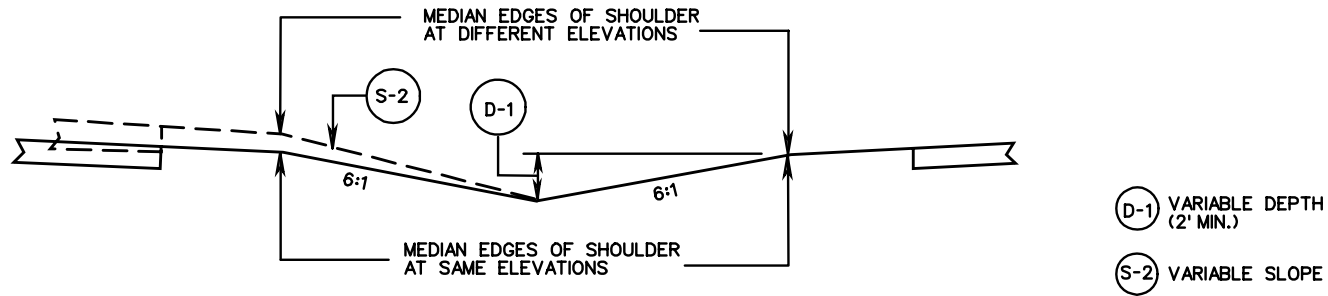

HOLD A 6:1 SLOPE FROM THE EDGES OF MEDIAN SHOULDERS (FROM THE LOWER MEDIAN SHOULDER IF AT DIFFERENT ELEVATIONS) TO THE CENTER OF MEDIAN.

MEDIAN EDGES OF SHOULDER AT DIFFERENT ELEVATIONS

(GRADING FROM HIGH SHOULDER TO DITCH ADJACENT TO LOWER ROADWAY)

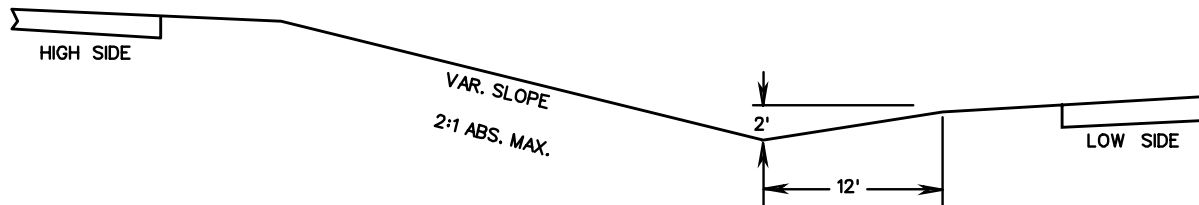

HOLD A 2' DITCH DEPTH, 12' WIDE, ADJACENT TO LOWER SHOULDER.



ROAD AND BRIDGE STANDARDS

SHEET 1 OF 1

REVISION DATE

702.04

STANDARD GRADED MEDIAN DESIGNS

VIRGINIA DEPARTMENT OF TRANSPORTATION

SPECIFICATION REFERENCE