

STANDARD	TITLE	PAGE
RW-2	CONCRETE GRAVITY RETAINING WALLS - LEVEL BACKFILL	401.01
RW-3	CONCRETE GRAVITY RETAINING WALLS INFINITE SURCHARGE AND DECK SURCHARGE - LOADED	401.02
RW-2, 3	SUGGESTED RUSTICATION TREATMENTS FOR RETAINING WALLS	401.03
CW-1	STANDARD REINFORCED CONCRETE CRIB WALL	402.01
	STANDARD REINFORCED CONCRETE CRIB WALL	402.02

INDEX OF SHEETS
SECTION 400-RETAINING WALLS
 VIRGINIA DEPARTMENT OF TRANSPORTATION



ROAD AND BRIDGE STANDARDS

REVISION DATE

SHEET 1 OF 1

400.01

THIS PAGE INTENTIONALLY LEFT BLANK



ROAD AND BRIDGE STANDARDS

SHEET 1 OF 1

REVISION DATE

400.02

VIRGINIA DEPARTMENT OF TRANSPORTATION

SPECIFICATION
REFERENCE

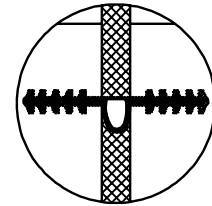
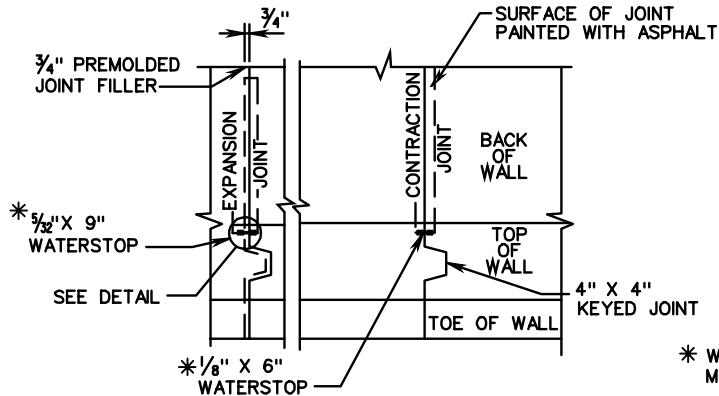

**WATERSTOP
DETAIL**

* WATER STOPS TO BE ELASTOMERIC OR OTHER APPROVED MATERIAL. DIMENSIONS SHOWN ARE ABSOLUTE MINIMUM.
EXPANSION JOINTS AT INTERVALS NOT EXCEEDING 90'.

HEIGHT OF WALL "H" IN FEET	THICKNESS AT TOP "A" IN FEET	THICKNESS AT BASE B=4H	COMPRESSION AT TOE LBS. PER SQ. FT.	AREA OF SECTION SQ. FT.
2	1'-0"	1'-0"	627	2.63
3	"	1'-2 3/8"	1009	3.93
4	"	1'-7 1/4"	1369	5.83
5	"	2'-0"	1709	8.13
6	"	2'-4 3/4"	2049	10.83
7	"	2'-9 5/8"	2385	13.93
8	"	3'-2 3/8"	2720	17.43
9	"	3'-7 1/4"	3054	21.33
10	"	4'-0"	3386	25.63
11	"	4'-4 3/4"	3718	30.33
12	"	4'-9 5/8"	4050	35.43
13	"	5'-2 3/8"	4381	40.93
14	"	5'-7 1/4"	4712	46.83
15	"	6'-0"	5043	53.13

H - HEIGHT IN FT.
A - 1'
BASE - 4/10 H
EARTH - 100 LBS.
CONCRETE - 150 LBS.
ANGLE OF REPOSE - 1 1/2: 1

POROUS BACKFILL @ 100 LBS./CU. FT.
#78 OR #8 AGGREGATE OR CRUSHED GLASS
MEETING #78 OR #8 GRADATION REQUIREMENTS

3" DRAIN PIPE 8' APART
WEEP HOLE WITH 12"X12" PLASTIC HARDWARE CLOTH 1/4" MESH OR GALVANIZED STEEL WIRE, MINIMUM WIRE DIAMETER 0.03", #4 MESH HARDWARE CLOTH ANCHORED FIRMLY TO OUTSIDE OF STRUCTURE.

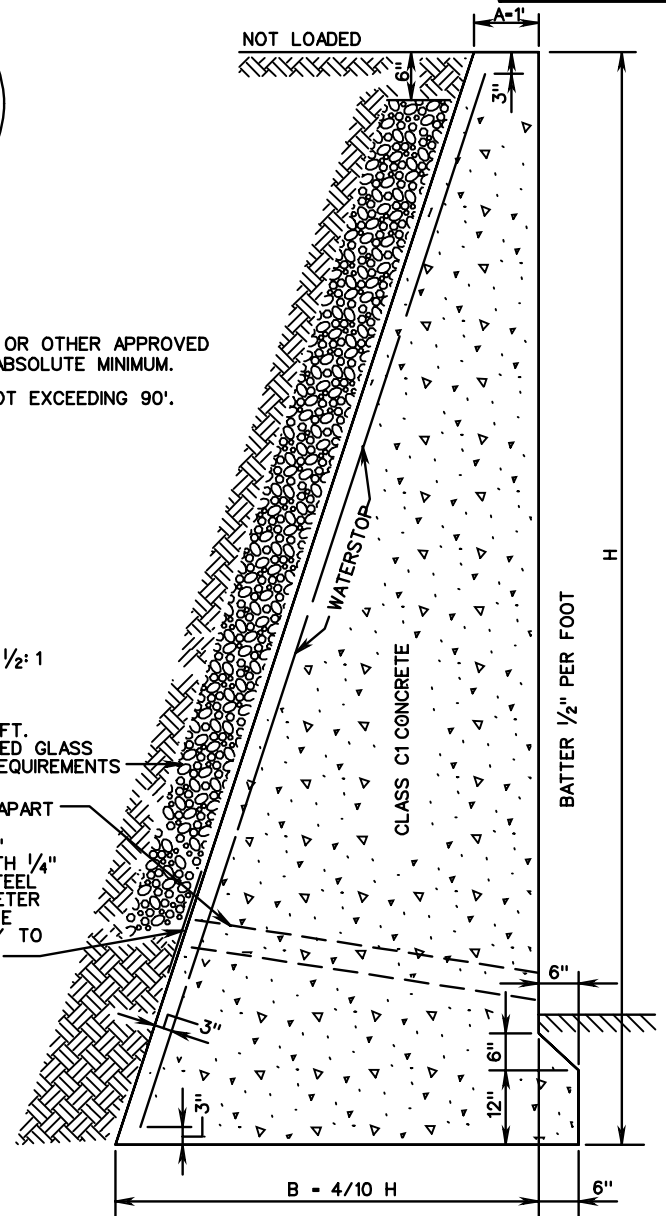

NOTE:
IF COMPRESSION AT TOE EXCEEDS SAFE BEARING CAPACITY OF SOIL, A SPECIAL FOOTING IS TO BE USED.
DEPTH OF WALL IN GROUND DETERMINED BY CONDITIONS. TO BE NOT LESS THAN 1'-6".

SAFE BEARING CAPACITY OF SOIL	
ROCK MINIMUM.....	10,000 - 20,000 LBS. PER SQ. FT.
GRAVEL AND COARSE SAND, WELL CEMENTED	16,000 - 20,000 LBS. PER SQ. FT.
CLAY IN THICK BEDS, ALWAYS DRY.....	12,000 - 16,000 LBS. PER SQ. FT.
CLAY IN THICK BEDS, MODERATELY DRY.....	8,000 - 12,000 LBS. PER SQ. FT.
CLAY, SOFT	2,000 - 4,000 LBS. PER SQ. FT.
SAND, DRY, COMPACT, AND WELL CEMENTED	8,000 - 12,000 LBS. PER SQ. FT.
SAND, CLEAN, DRY	4,000 - 8,000 LBS. PER SQ. FT.
ALLUVIAL SOILS, ETC	1,000 - 2,000 LBS. PER SQ. FT.

SPECIFICATION REFERENCE
506

CONCRETE GRAVITY RETAINING WALL - LEVEL BACKFILL

VIRGINIA DEPARTMENT OF TRANSPORTATION

VDOT	
ROAD AND BRIDGE STANDARDS	
REVISION DATE	SHEET 1 OF 1
401.01	

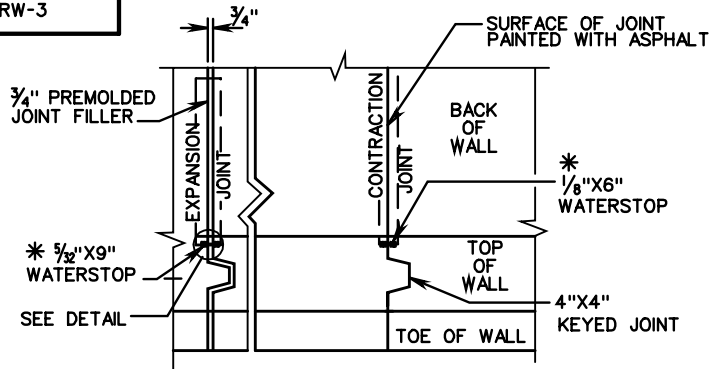

CONTRACTION JOINTS AT INTERVALS NOT EXCEEDING 30'.
 EXPANSION JOINTS AT INTERVALS NOT EXCEEDING 90'.

* WATER STOPS TO BE ELASTOMERIC OR OTHER APPROVED MATERIAL. DIMENSIONS SHOWN ARE ABSOLUTE MINIMUM.

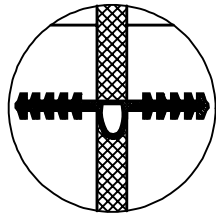

WATERSTOP
DETAIL

HEIGHT OF WALL "H" IN FEET	THICKNESS AT TOP "A" IN FEET	THICKNESS AT BASE B=.6H	COMPRESSION AT TOE LBS. PER SQ. FT.	AREA OF SECTION SQ. FT.
3	1'-0"	1'-9 5/8"	856	4.83
4	1'-0"	2'-4 3/4"	1141	7.43
5	1'-0"	3'-0"	1427	10.63
6	1'-0"	3'-7 1/4"	1712	14.43
7	1'-0"	4'-2 3/8"	1997	18.83
8	1'-0"	4'-9 5/8"	2283	23.83
9	1'-0"	5'-4 3/4"	2568	29.43
10	1'-0"	6'-0"	2853	35.63
11	1'-1 1/4 "	6'-7 1/4"	3139	42.98
12	1'-2 3/8 "	7'-2 3/8"	3424	51.03
13	1'-3 5/8 "	7'-9 5/8"	3709	59.78
14	1'-4 3/4 "	8'-4 3/4"	3995	69.23
15	1'-6"	9'-0"	4280	79.38

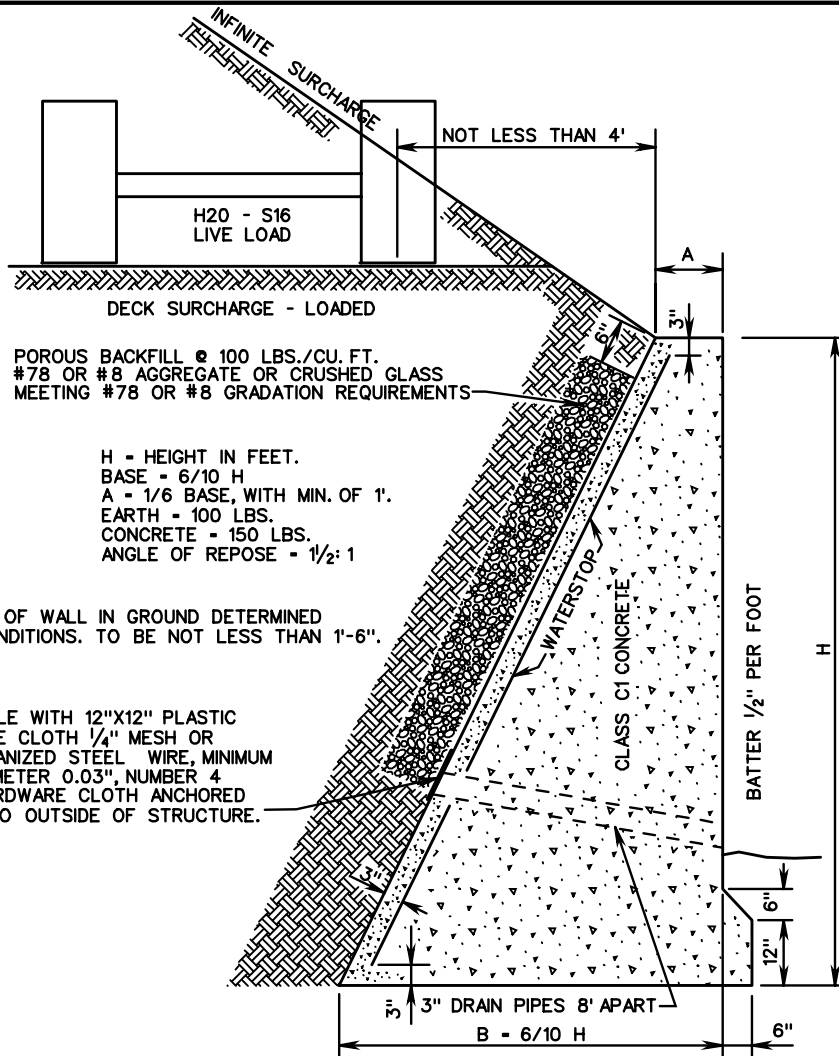

NOTE:
 DEPTH OF WALL IN GROUND DETERMINED BY CONDITIONS. TO BE NOT LESS THAN 1'-6".

WEEP HOLE WITH 12"X12" PLASTIC HARDWARE CLOTH 1/4" MESH OR GALVANIZED STEEL WIRE, MINIMUM WIRE DIAMETER 0.03", NUMBER 4 MESH HARDWARE CLOTH ANCHORED FIRMLY TO OUTSIDE OF STRUCTURE.

SAFE BEARING CAPACITY OF SOIL	
ROCK MINIMUM.....	10,000 - 20,000 LBS. PER SQ. FT.
GRAVEL AND COARSE SAND, WELL CEMENTED	16,000 - 20,000 LBS. PER SQ. FT.
CLAY IN THICK BEDS, ALWAYS DRY.....	12,000 - 16,000 LBS. PER SQ. FT.
CLAY IN THICK BEDS, MODERATELY DRY.....	8,000 - 12,000 LBS. PER SQ. FT.
CLAY, SOFT.....	2,000 - 4,000 LBS. PER SQ. FT.
SAND, DRY, COMPACT, AND WELL CEMENTED	8,000 - 12,000 LBS. PER SQ. FT.
SAND, CLEAN, DRY	4,000 - 8,000 LBS. PER SQ. FT.
ALLUVIAL SOILS, ETC	1,000 - 2,000 LBS. PER SQ. FT.

NOTE: IF COMPRESSION AT TOE EXCEEDS SAFE BEARING CAPACITY OF SOIL, A SPECIAL FOOTING IS TO BE USED.



CONCRETE GRAVITY RETAINING WALLS INFINITE SURCHARGE AND DECK SURCHARGE - LOADED

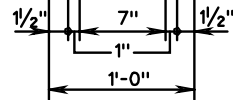
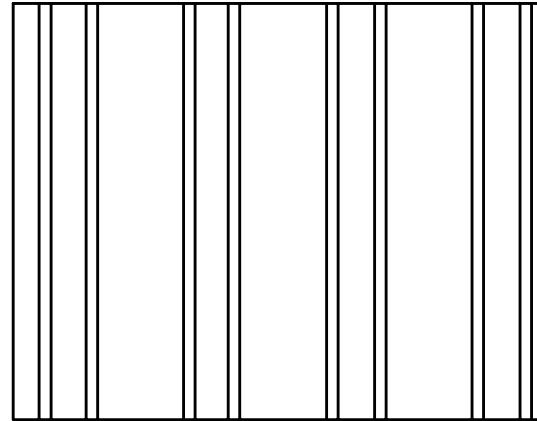
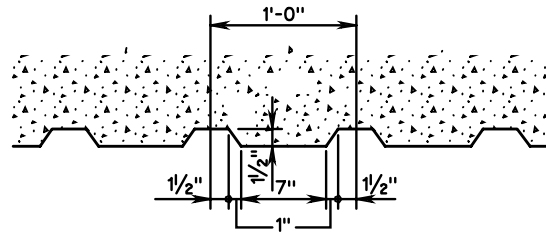

VERTICAL GROOVE

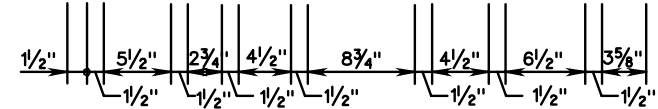
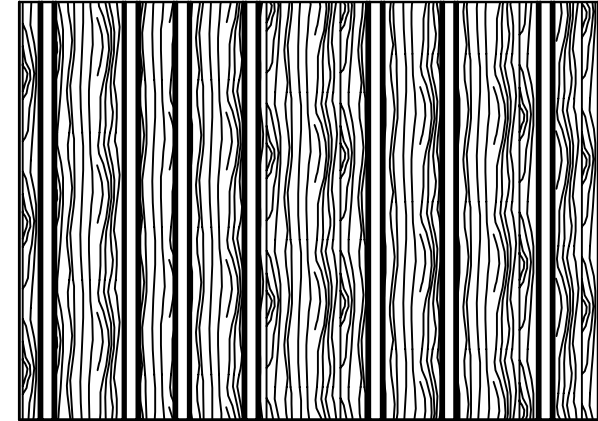
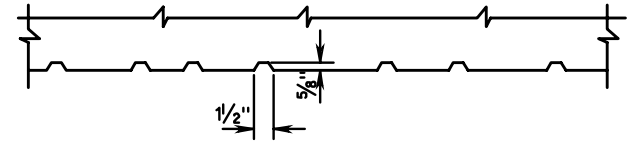

RANDOM BOARD RUSTICATION

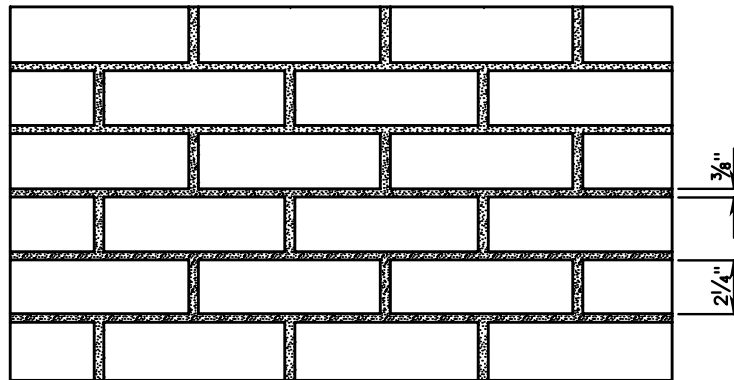

BRICK

NOTES:

RUSTIC TREATMENTS FOR STANDARD RW-2 AND RW-3 CONCRETE GRAVITY RETAINING WALLS ARE TO BE CONSIDERED WHERE LARGE AREAS ARE SUBJECT TO VIEWING BY GENERAL PUBLIC. AS A GENERAL GUIDELINE THE USE OF SUCH TREATMENT WILL BE CONSIDERED ON WALLS WHERE THE HEIGHT IS 3' OR GREATER.

THE SELECTION OF THE PROPOSED TREATMENT SHOULD BE MADE AT THE FIELD INSPECTION REVIEW AND PARTICULAR ATTENTION GIVEN IF THE PROPOSED WALL TIES INTO A BRIDGE ABUTMENT TO INSURE THAT BOTH HAVE THE SAME TREATMENT.

IF ENVIRONMENTAL CONSIDERATIONS DICTATE, OTHER TYPES OF TREATMENTS CAN BE USED.

SPECIFICATION REFERENCE

506

SUGGESTED RUSTICATION TREATMENTS FOR RETAINING WALLS

VIRGINIA DEPARTMENT OF TRANSPORTATION

VDOT

ROAD AND BRIDGE STANDARDS

REVISION DATE

SHEET 1 OF 1

401.03

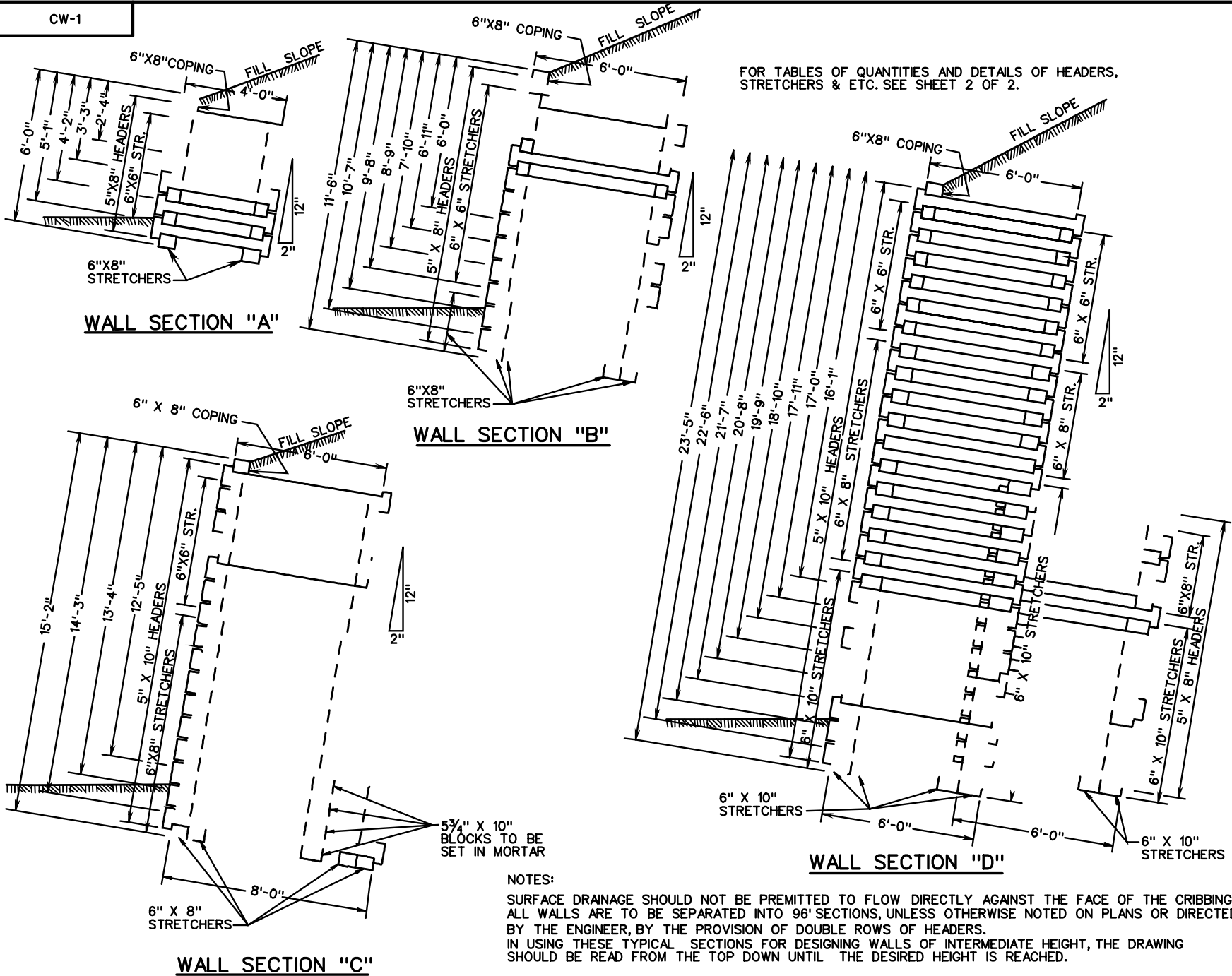

FOR TABLES OF QUANTITIES AND DETAILS OF HEADERS, STRETCHERS & ETC. SEE SHEET 2 OF 2.

NOTES:
 SURFACE DRAINAGE SHOULD NOT BE PERMITTED TO FLOW DIRECTLY AGAINST THE FACE OF THE CRIBBING. ALL WALLS ARE TO BE SEPARATED INTO 96' SECTIONS, UNLESS OTHERWISE NOTED ON PLANS OR DIRECTED BY THE ENGINEER, BY THE PROVISION OF DOUBLE ROWS OF HEADERS.
 IN USING THESE TYPICAL SECTIONS FOR DESIGNING WALLS OF INTERMEDIATE HEIGHT, THE DRAWING SHOULD BE READ FROM THE TOP DOWN UNTIL THE DESIRED HEIGHT IS REACHED.

VDOT	
ROAD AND BRIDGE STANDARDS	
SHEET 1 OF 2	REVISION DATE
402.01	

STANDARD REINFORCING CONCRETE CRIB WALL

VIRGINIA DEPARTMENT OF TRANSPORTATION

SPECIFICATION REFERENCE
506

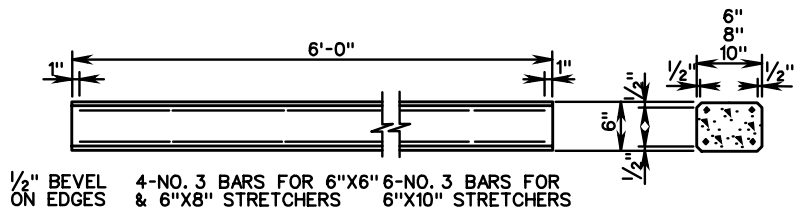

1/2" BEVEL ON EDGES 4-NO. 3 BARS FOR 6"X6" STRETCHERS & 6"X8" STRETCHERS 6-NO. 3 BARS FOR 6"X10" STRETCHERS

STRETCHERS

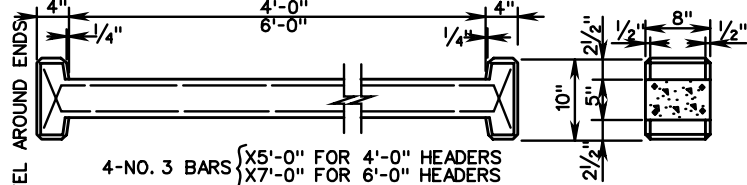

4-NO. 3 BARS { X5'-0" FOR 4'-0" HEADERS X7'-0" FOR 6'-0" HEADERS

5"X8" HEADERS

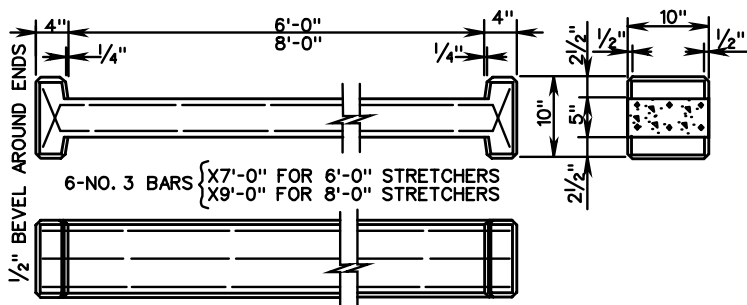

6-NO. 3 BARS { X7'-0" FOR 6'-0" STRETCHERS X9'-0" FOR 8'-0" STRETCHERS

5"X10" HEADERS

UNIT	WEIGHT	CU. FT.
5"X8"X4'-0" HEADER	235#	1.48
5"X8"X6'-0" HEADER	325#	2.04
5"X10"X6'-0" HEADER	405#	2.55
5"X10"X8'-0" HEADER	515#	3.24
6"X6"X6'-0" STRETCHER	240#	1.50
6"X8"X6'-0" HEADER	320#	2.00
6"X10"X6'-0" HEADER	400#	2.50
5 3/4"X10"X10" BLOCK	50#	0.33

NOTES:
ALL REINFORCING TO BE NO. 3 BARS PLACED 1" CLEAR FROM SURFACE OF CONCRETE.

BARS TO BE HELD IN POSITION BY CHAIRS HAVING NON-CORROSIVE TIPS
CLASS A-5 CONCRETE TO BE USED EXCEPT MAXIMUM SIZE AGGREGATE TO BE NO. 7.

HEIGHT OF WALL	UNITS REQUIRED FOR TYPICAL WALL 96' LONG						WALL SECTION	
	HEADERS			STRETCHERS				BL'K'S
	5"X8" X4'-0"	5"X8" X6'-0"	5"X10" X6'-0"	5"X10" X8'-0"	6"X6" X6'-0"	6"X8" X6'-0"		
2'-4"	34				32	48		
3'-3"	51				64	48		
4'-2"	68				96	48		
5'-1"	85				128	48		
6'-0"	102				160	48		
6'-0"		102			224	16		
6'-11"		119			256	16		
7'-10"		136			288	16		
8'-9"		153			320	16		
9'-8"		170			288	80		
10'-7"		187			288	112		
11'-6"		204			288	144		
12'-5"			204	17	192	272	17	
13'-4"			204	34	192	304	34	
14'-3"			204	51	192	336	51	
15'-2"			204	68	192	368	68	
16'-1"		68	289		192	336	144	
17'-0"		85	306		192	320	208	
17'-11"		102	323		192	320	256	
18'-10"		119	340		192	320	304	
19'-9"		136	357		192	320	352	
20'-8"		153	374		192	320	400	
21'-7"		170	391		192	320	448	
22'-6"		187	408		192	320	496	
23'-5"		204	425		192	320	544	

CRIBBING IS TO BE PLACED ON A FOUNDATION OF FIRM BEARING MATERIAL MEETING THE APPROVAL OF THE ENGINEER.

THIS FOUNDATION IS TO BE AT LEAST 3' BELOW THE SURFACE OF THE GROUND, BEYOND ALL DANGER OF FROST, UNLESS ON SOLID ROCK.

FOR DETAILS NOT SHOWN ON THIS SHEET, SEE SHEET 1 OF 2.

BLOCKS SHALL BE SET IN MORTAR.

SPECIFICATION REFERENCE

506

STANDARD REINFORCED CONCRETE CRIB WALL

VIRGINIA DEPARTMENT OF TRANSPORTATION

VDOT

ROAD AND BRIDGE STANDARDS

REVISION DATE

SHEET 2 OF 2

402.02

THIS PAGE INTENTIONALLY LEFT BLANK



ROAD AND BRIDGE STANDARDS

SHEET 1 OF 1

REVISION DATE

402.03

VIRGINIA DEPARTMENT OF TRANSPORTATION

SPECIFICATION
REFERENCE